

CUTTING TOOL CATALOGUE

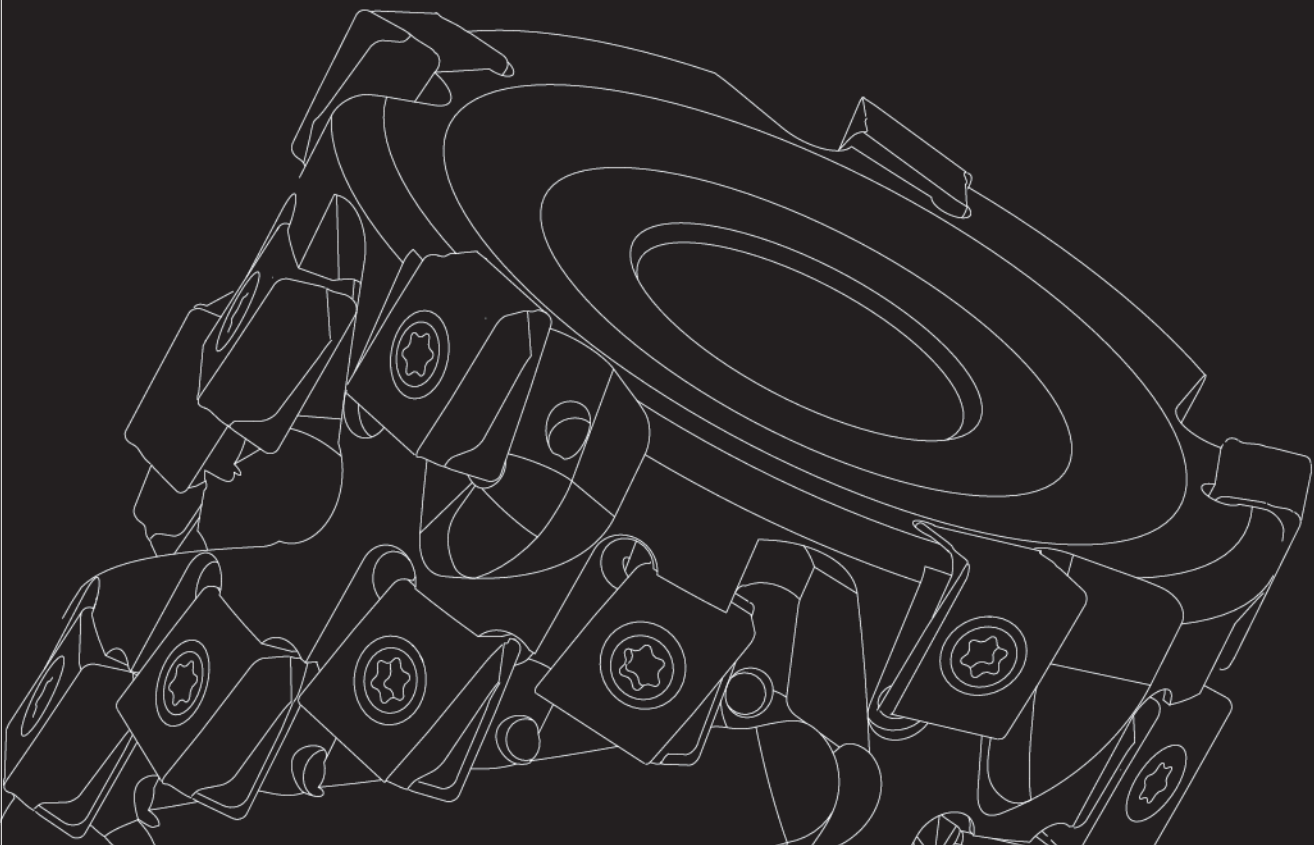

Company Profile

Ganzhou Achteck Tool Technology Co., Ltd. is a wholly-owned subsidiary of Chongyi Zhangyuan Tungsten Co., Ltd. (Listed Company with stock code 002378). The registered capital of Achteck is 260 million USD with 600 employees. The main products include: Coated Carbide Inserts, Carbide Rods and etc. Achteck has the outstanding R&D competence, the production and testing equipments, and the coated carbide insert production technology. The inserts covering Turning, Grooving, Milling and Drilling are widely applied in automotive, energy, die & mold, general machinery, aerospace and other industries.

Achteck Tool is technology oriented, owns a strong research team and keeps on innovation. Having "Benefit from Resources, Reliance on Technologies, Devotion to Humanity and Top with Trust" as the operation philosophy and "Safety, Harmony, Efficiency and Innovation" as the target, Achteck aims to become a well-known brand in the world and a first-class cemented carbide manufacturer in China.



Swiss Tool Inserts

2021
NEW

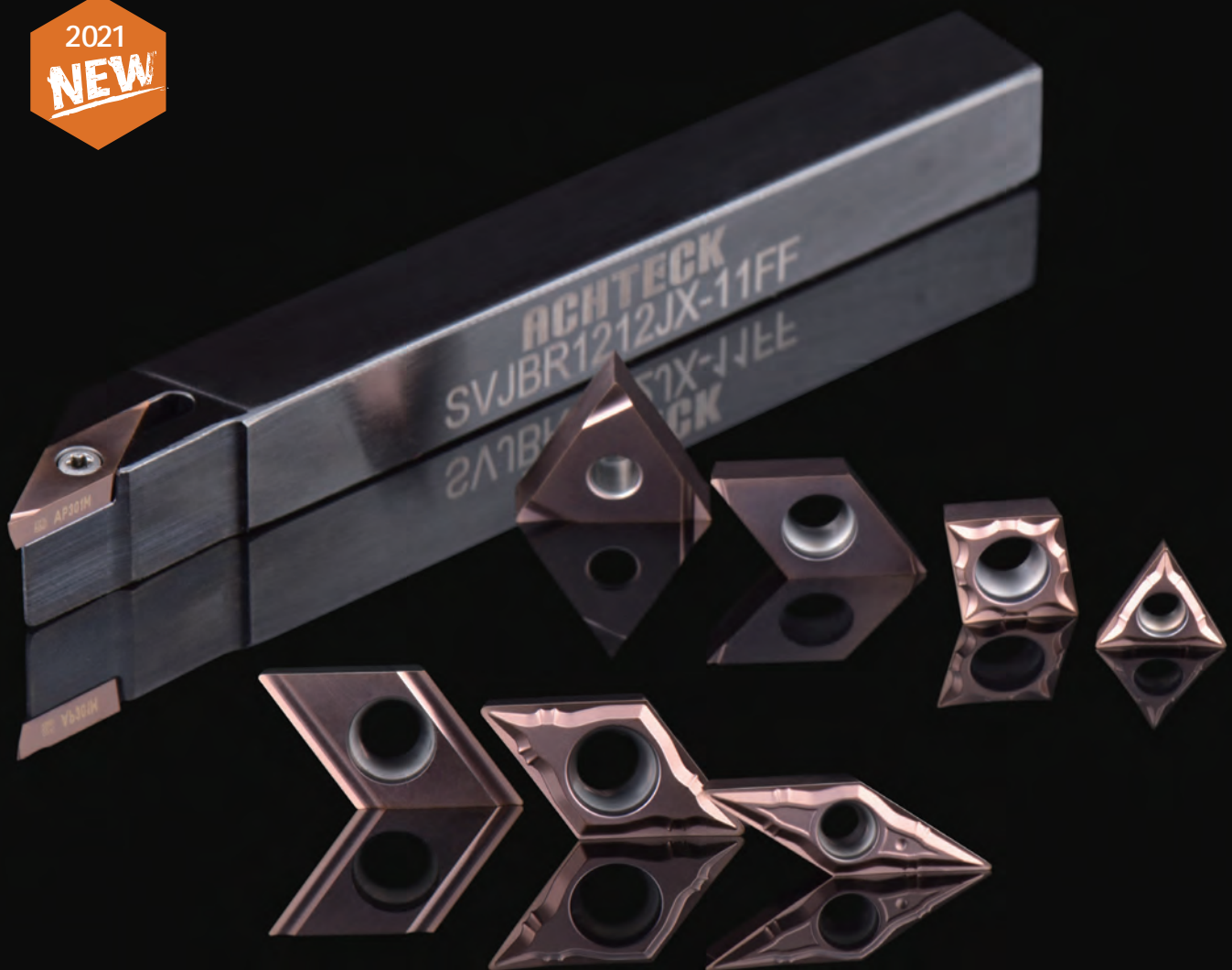

AP301M Features

PVD grade for stainless steel turning
Good machining performance, reduced built up edge, better surface finish, and longer tool life
Submicron cemented carbide substrate combined with nanostructured multi layer PVD coating
Good wear resistance and chipping resistance
Obtain more reliable machining performance
For continuous and interrupt cutting

Cermet

AT200

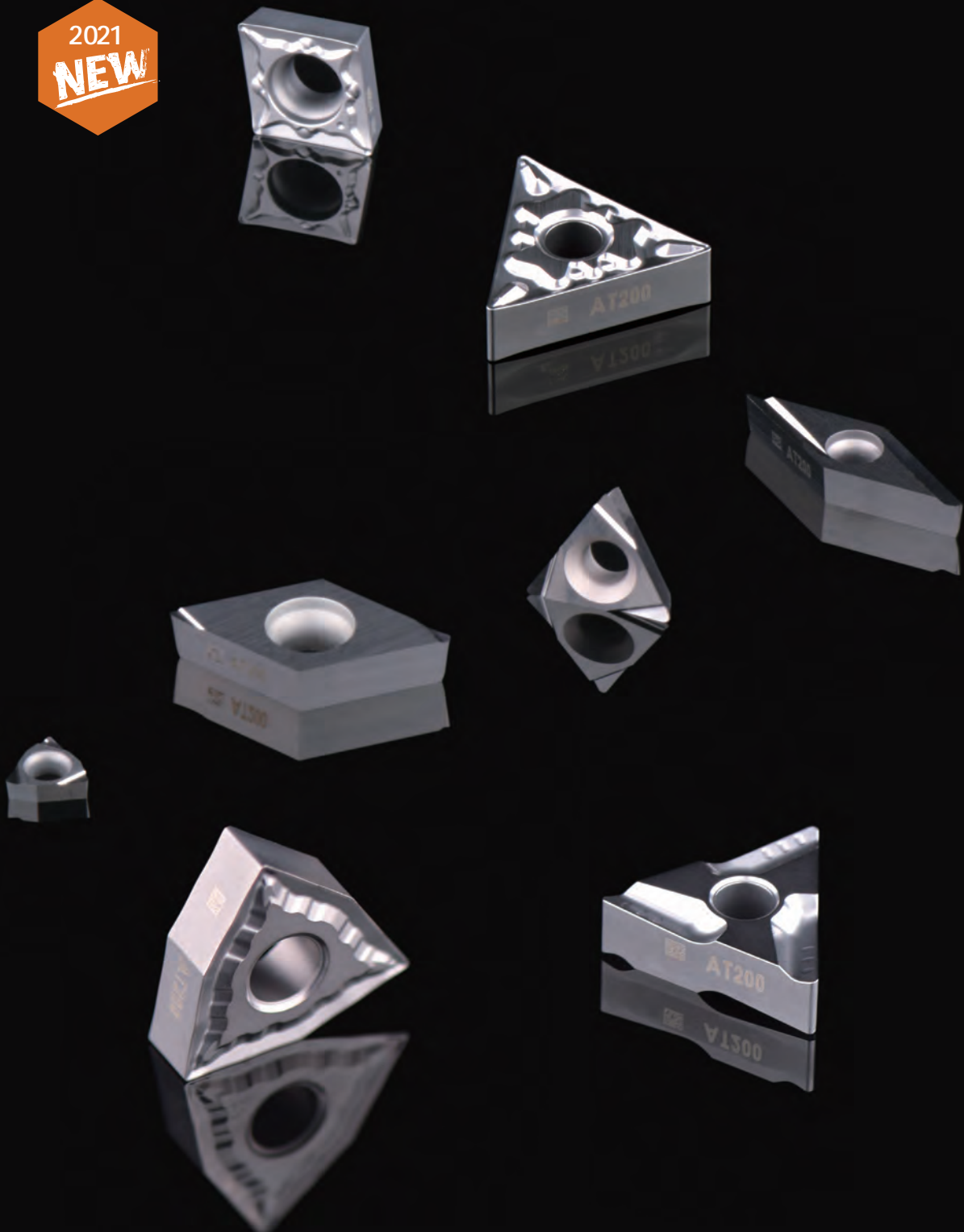

Product Features and Applications

- Suitable for steel and cast iron finish and semi-finish turning, high oxidation resistance, can be used in high-speed dry machining
- High chemical stability, effectively reduced built up edge to obtain better surface finish

Grooving Tool

2021
NEW



Product Features and Applications

- Holders can cover external, internal and face grooving.
- Insert width range: 2-8mm
- Three parting and grooving geometries: CS, CM, CH
- Two turning geometries: TM, TS.
- Two Profiling geometries: RM, RA
- High precision ground insert series, covering 1-8mm insert width, can be used in parting, grooving and profiling machining.
- Unique rake geometry design combined with double relief angle on the flank, obtained more clearance in smaller diameter face grooving and internal grooving

Profile Milling

APM00-RO

Product Features and Applications

- Main applications in blade and aircraft component profile milling
- Inserts are with anti-rotation design
- New AP403S and AP403M grade can cover stainless steel and super alloy machining
- Cutter diameter range: $\Phi 25\text{mm}$ - $\Phi 160\text{mm}$
- MM3 geometry, precision ground flank and optimized cutting edge treatment, offer longer insert tool life
- Multiple coupling types: screw clamping, cylindrical shank and arbor cutter



Product Features and Applications

- AFF40-LN12/LN15 series cutters are mainly used in cast iron engine cylinder block, cylinder head and other kinds of valve housing type milling
- The cutter used 40° approaching angel, close pitch design guaranteed high productivity
- Stable wedge clamping for main cutting inserts, easy to handle
- Wiper inserts are easy to be adjusted and reliable, can achieve good surface finish
- 16 cutting edges of each insert, offer constant performance and high cost efficiency.
- Cutter surface is blackened, with high precision insert pockets, and good wear resistance



AFF40-LN12/LN15

Cast Iron Finishing Milling Cutter



Product Features and Applications

LN09 insert series can be used not only in square shoulder milling cutter, but also in porcupine cutter

- Accurate 90° square shoulder milling cutter provides excellent verticality
- Tangential mounted insert design offers strong insert toughness with better cutter rigidity.
- Positive axial angle design makes the cutting smoothly. H-class insert tolerance offers high repeatability of insert positioning
- Double-sided 4-edge insert, more cost efficient choice, while each insert is with wiper edge which can obtain good surface finish
- Full tooth type of porcupine milling cutter, with high metal removal rate, large cutting depth, high efficiency, known as the "powerful tool for rough machining"

LN09

Shoulder Milling

Product Features and Applications

- Product range: 3*Dc and 5*Dc. With internal and external coolant,
- Diameter range: 3-16mm;
- 140° drill tip angle design, good versatility, suitable for drilling in different materials
- Nanostructured PVD coating technology improves the toughness and wear resistance of tools.



D106

Solid Carbide Drill for Universal Use



AFM45-XN09-W milling cutter with heptagon inserts, extra close pitch with wedge clamping, combined with heat resistant CVD coated inserts. The ideal choice of cast iron rough milling.



APE90-LN09/LN13 porcupine milling cutter uses tangential insert with helical edge profile. The high strength insert have 4 cutting edges, offering high productivity, machining reliability and cost efficiency.

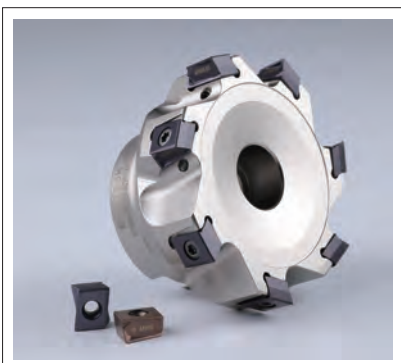

ASM90-LN09/LN13 square shoulder milling cutter with 4 cutting edge tangential inserts with helical edge profile. The reliable cutting edge can adopt increased fz by 30%, and also bring on higher metal removal rate and productivity.

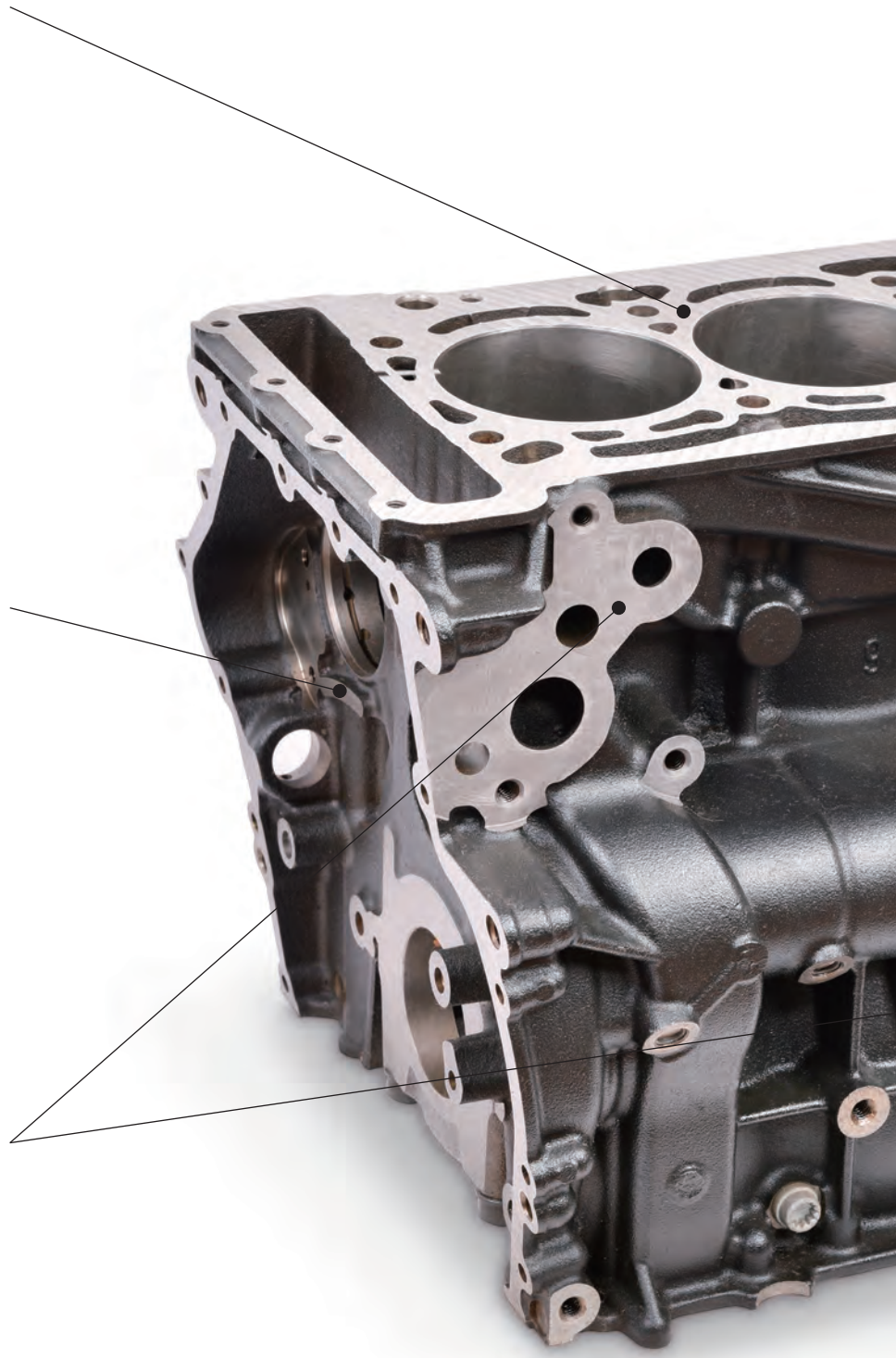

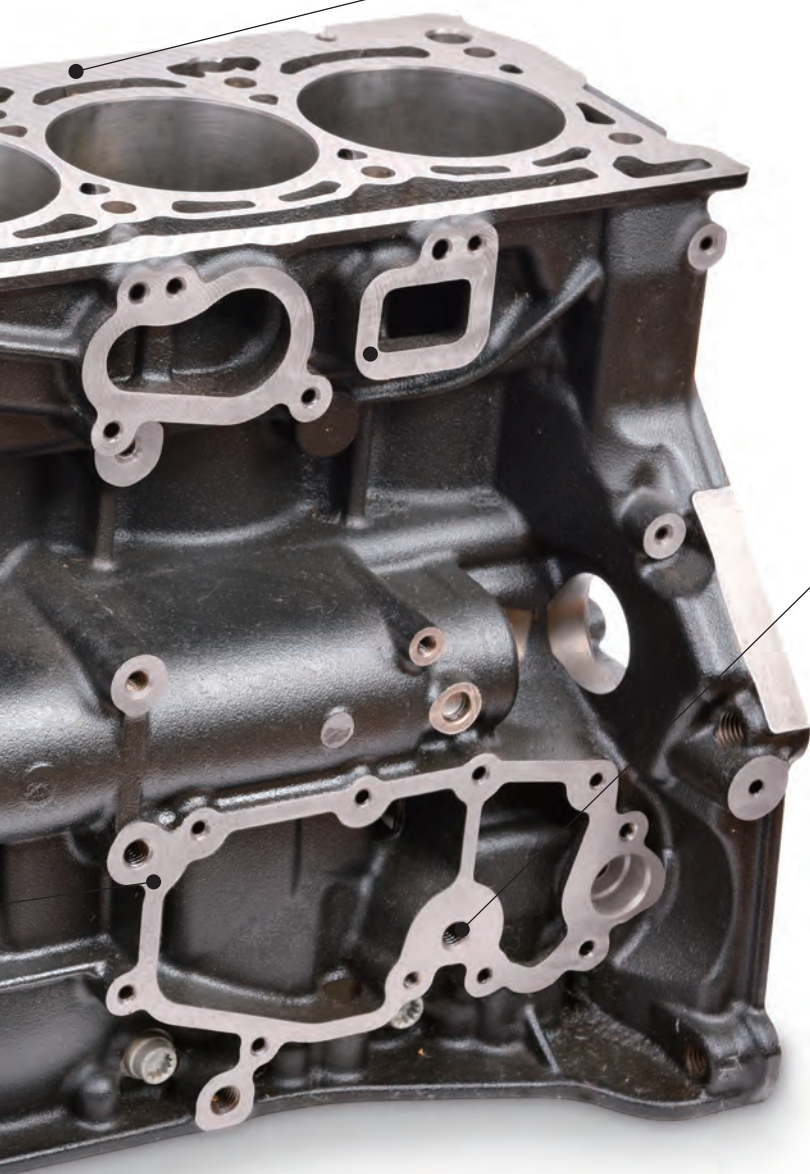

AFF0-LN15 cast iron finish milling cutter, combined with octagon main cutting inserts and wiper inserts. It's cost efficient and easy to handle. The good wear resistant grade and high precision cutting edge guaranteed excellent surface finishing and longer tool life.



D106 drill series, the substrate has both hardness and toughness, combined with high wear resistant PVD coating. It can reach higher tool life in cast iron machining. The unique drill tip geometry can reduce the edge chipping.

ACHTECK
www.achtecktool.com

Machining Solutions for Engine Block

Turbocharger Housing Application Case



Special side face milling cutter used in machining the back face of flange.

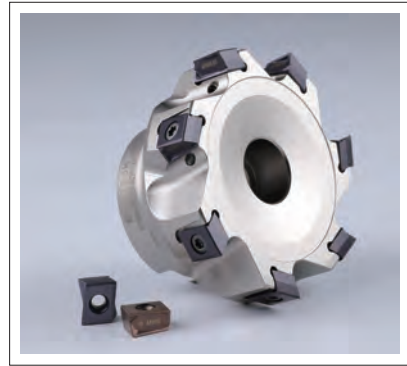

ASM90-LN13 square shoulder milling cutter with tangential mounted inserts. The insert has 4 cutting edges, can be used to machine the boss surface on the turbocharger.

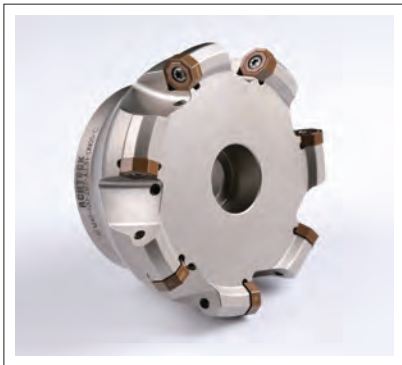

AFM40-ON05-C-45, with 45 degree approach angle, using 16 cutting edge insert with wiper edge. Used in finish milling the flange face of turbocharger casing



AFM45-XN07 face milling cutter with heptagon inserts, 14 cutting edges, with nanostructured PVD coating. Used in rough milling the flange face, with a high performance/cost ratio.





AP100S/AP301M PVD grades, used in rough external turning and face turning of turbocharger housing



ATD grooving insert series can be used in external, face and V-shaped grooving.



Special boring tool, used in the turbocharger housing boring.

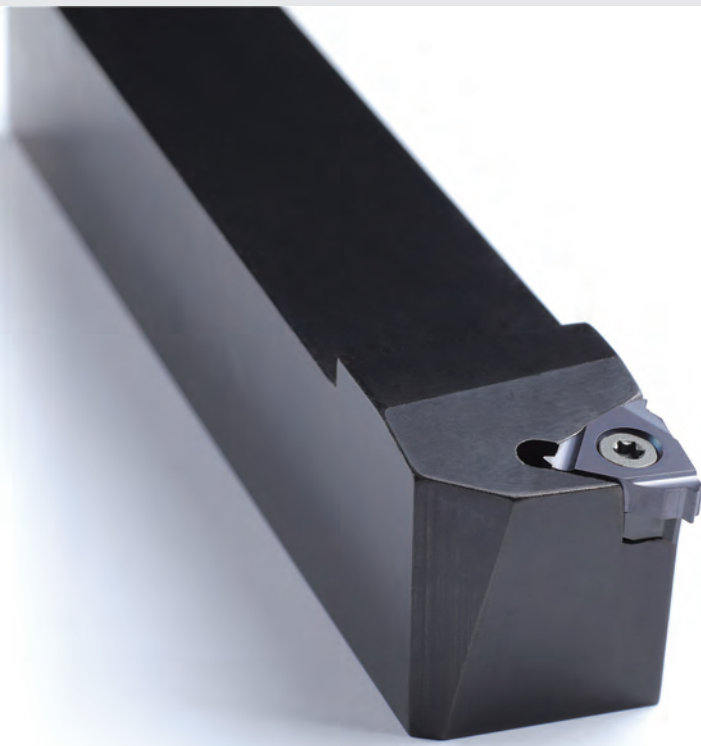

16ER 1.00 ISO AP351U threading insert, used in threading operation of turbine shaft.



ACHTECK

www.achtecktool.com

Turbine Shaft Machining Cases

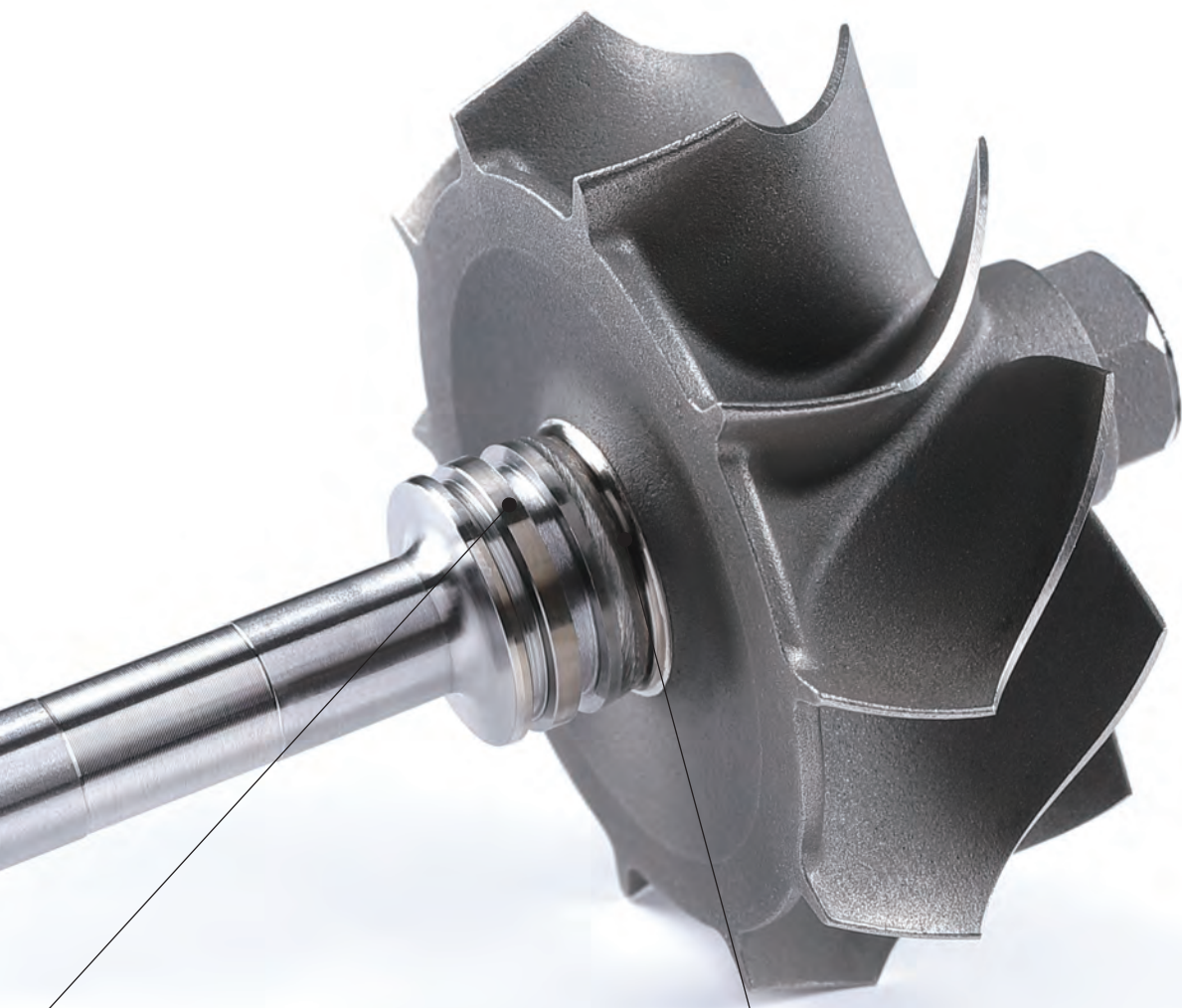

Grooving holder ATSER2525-3T12 and grooving insert ATD302-TS AP301U are used in external grooving of turbine shaft.



DNMG150608-SC3 AP100S, turning insert for heat resistant alloy, used in brazed surface contour machining



APM00-RP06-12 cutter, used in rough milling of blade airfoil

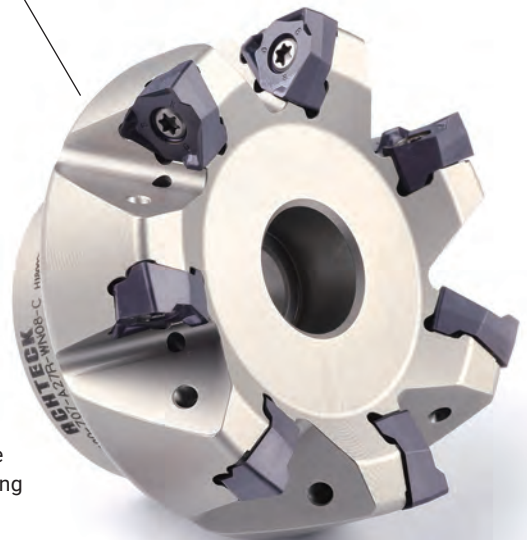
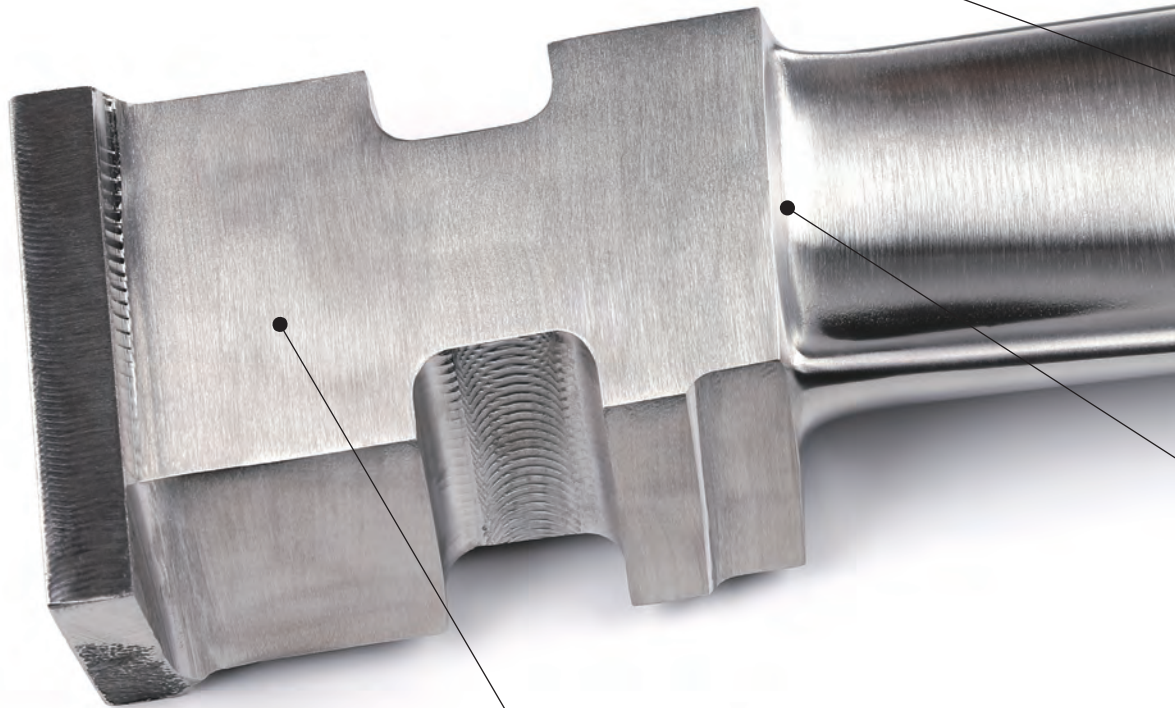

ASM90-WN08 square shoulder milling cutter with negative insert, 6 cutting edges, accurate 90 degree design, used in rough or finish milling blade root and shroud.

Steam Turbine and Aerospace Blade Solutions



APM00-RBM08-20 is used in rough milling the transition area between blade airfoil and root

ACHTTECK

www.achtecktool.com



CUTTING TOOL CATALOGUE

Turning inserts	18
ISO turning insert denomination system	20
Overview of turning insert geometries	22
Grade application guide	32
Turning grade description	33
Ap-feed rate application diagram	70
Cutting parameter recommendation table	72
PCBN insert denomination system	74
PCBN grade application guide	75
PCBN inserts	76
PCD insert denomination system	86
PCD grade application guide	87
PCD inserts	88

ISO Turning Insert Denomination System

C
1

N
2

M
3

G
4

1- Shape/code

A	B	C	D	E
H	K	L	M	O
P	R	S	T	V
W	Z	Others		

2- Clearance angle

A	B	C	D
E	F	G	N
P	O	Other clearance angle	

3- Tolerance

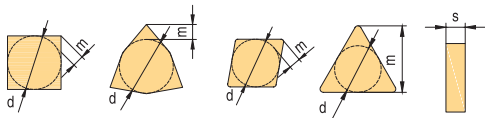

Class	Unit	In. Circle dimension d	Nose height m	Thickness s
A	mm	± 0,025	± 0,005	± 0,025
C	mm	± 0,025	± 0,013	± 0,025
E	mm	± 0,025	± 0,025	± 0,025
F	mm	± 0,013	± 0,005	± 0,025
G	mm	± 0,025	± 0,025	± 0,130
H	mm	± 0,013	± 0,013	± 0,025
J	mm	*	± 0,005	± 0,025
K	mm	*	± 0,013	± 0,025
L	mm	*	± 0,025	± 0,025
M	mm	*	*	± 0,127
U	mm	*	*	± 0,127
N	mm	*	*	± 0,025

* For details refer to right and below tables

Shape: C, E, H, M, O, P, S, T, R, W				
IC	d		m	
	J,K,L,M,N	U	M, N	U
4.76	± 0,05	± 0,08	± 0,08	± 0,13
5.56	± 0,05	± 0,08	± 0,08	± 0,13
6	± 0,05	± 0,08	± 0,08	± 0,13
6.35	± 0,05	± 0,08	± 0,08	± 0,13
7.94	± 0,05	± 0,08	± 0,08	± 0,13
8	± 0,05	± 0,08	± 0,08	± 0,13
9.525	± 0,05	± 0,08	± 0,08	± 0,13
10	± 0,05	± 0,08	± 0,08	± 0,13
12	± 0,08	± 0,13	± 0,13	± 0,2
12.7	± 0,08	± 0,13	± 0,13	± 0,2
15.875	± 0,1	± 0,18	± 0,15	± 0,27
16	± 0,1	± 0,18	± 0,15	± 0,27
19.05	± 0,1	± 0,18	± 0,15	± 0,27
20	± 0,1	± 0,18	± 0,15	± 0,27
25	± 0,13	± 0,25	± 0,18	± 0,38
25.4	± 0,13	± 0,25	± 0,18	± 0,38
31.75	± 0,15	± 0,25	± 0,2	± 0,38
32	± 0,15	± 0,25	± 0,2	± 0,38

M&N shape	D shape		V shape	
IC	d	m	d	m
5.56	± 0,05	± 0,11		
6.35	± 0,05	± 0,11	± 0,05	± 0,16
7.94	± 0,05	± 0,11	± 0,05	± 0,16
9.525	± 0,05	± 0,11	± 0,05	± 0,16
12.7	± 0,08	± 0,15	± 0,08	± 0,2
15.875	± 0,10	± 0,18	± 0,10	± 0,27
19.05	± 0,10	± 0,18	± 0,10	± 0,27

4 - Type of insert

A	B	C	F	G
H	J	M	N	Q
R	T	U	W	Z
				Special

12
5

04
6

5- Cutting edge length

In. Circle Dimension (mm)	insert shape							
	C	D	R	S	T	V	W	K
3.97					06			02
5.0			05					
5.56			09					
6.0		06						
6.35	06	07			11	11	04	
8.0			08					
9.525	09	11	09	09	16	16	06	16
10.0			10					
12.0			12					
12.7	12	15	12	12	22	22	08	
15.875	16		15	15	27			
16.0			16					
19.05	19		19	19	33			
20.0			20					
25.0			25					
25.4	25		25	25				
31.75			31					
32			32					

6- Thickness

Round down plus zero or T

Insert Shape	Example:
A, B, C, N, O, W	01 = 1.59 T1 = 1.98 02 = 2.38 03 = 3.18 T3 = 3.97 04 = 4.76
H, M, R, T	05 = 5.56 06 = 6.35 07 = 7.94
F, G, J, U	09 = 9.525 11 = 11.11 12 = 12.70 14 = 14.29 15 = 15.88

08
7

E
8

-
-

KC4
9

7- Nose radius

Corner radius

Example:

MO = round insert (metric)	
00 = Sharp	20 = 2.0
003 = 0.03	24 = 2.4
005 = 0.05	28 = 2.8
01 = 0.1	32 = 3.2
02 = 0.2	40 = 4.0
04 = 0.4	48 = 4.8
08 = 0.8	56 = 5.6
12 = 1.2	64 = 6.4
16 = 1.6	X = Others

Wiper

Approaching angle (Kr)	Wiper clearance angle (an)
A = 45°	A = 3°
D = 60°	B = 5°
E = 75°	C = 7°
F = 85°	D = 15°
G = 87°	E = 20°
P = 90°	F = 25°
Z = Others	G = 30°
	N = 0°
	P = 11°
	Z = Others

8- Edge preparation

Code	Edge Shape	Illustration
F		Sharp cutting edge
E		Honed cutting edge
T		Negative Land
S		Negative land + honed cutting edge



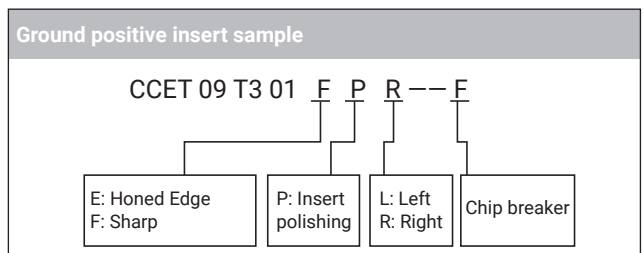

9-Chip breaker illustration







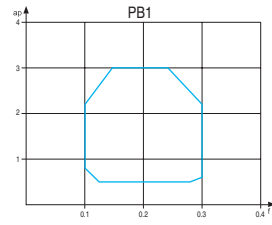
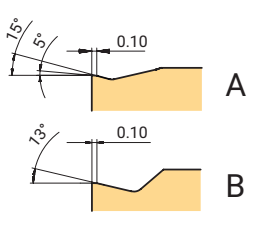
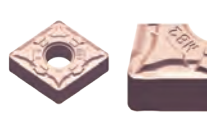
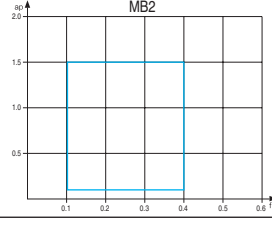
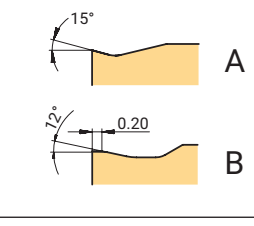
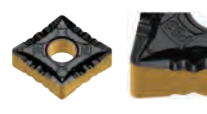
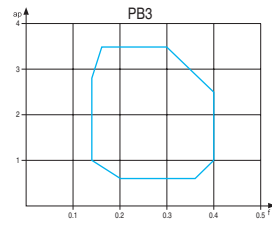
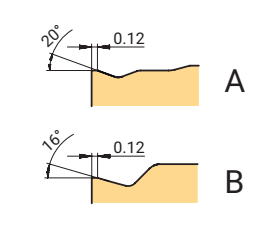
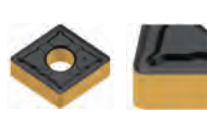
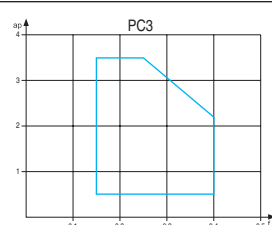
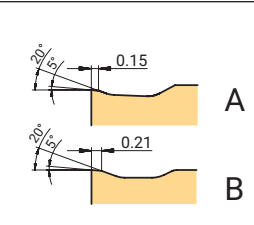

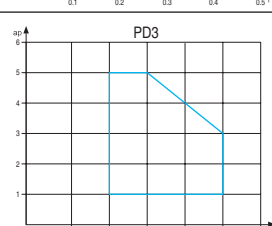
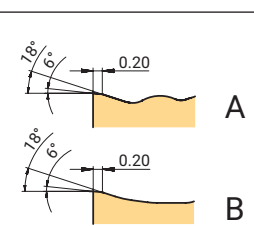
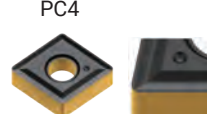
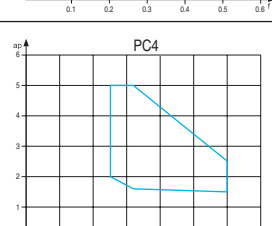
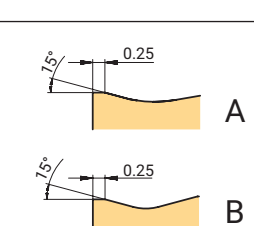
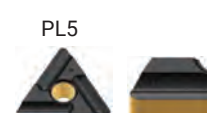
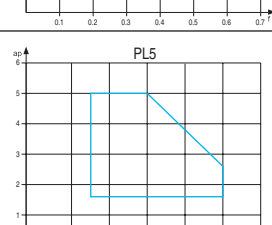
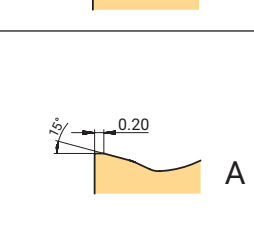















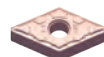





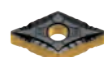



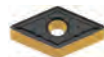







Refer to page : 22-33



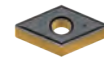







Overview of Turning Insert Geometries

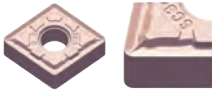
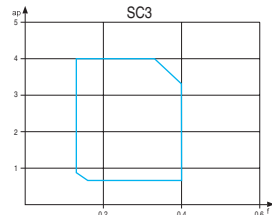
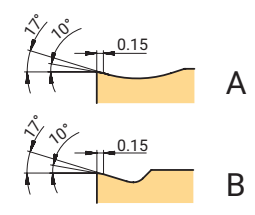
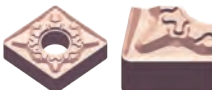
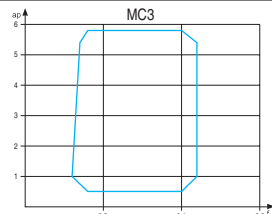
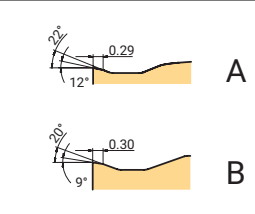

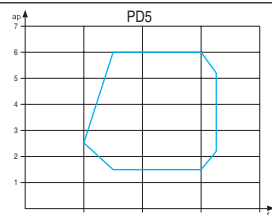
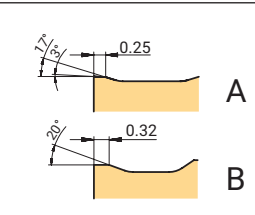

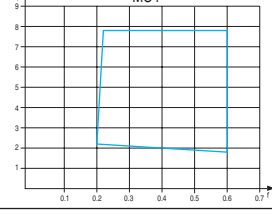
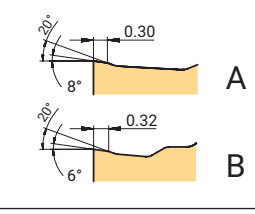
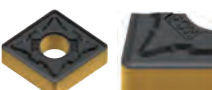
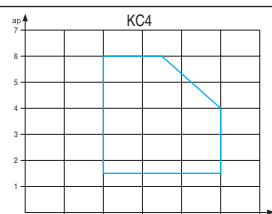
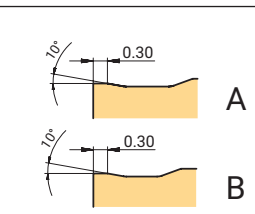
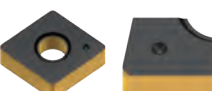
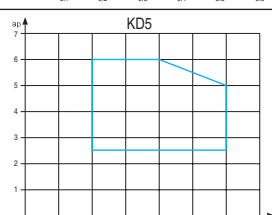
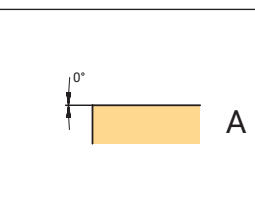

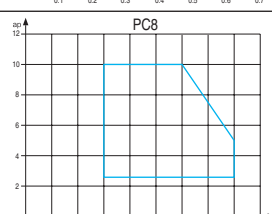
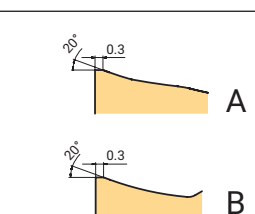

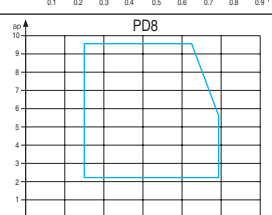
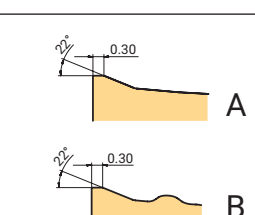



































Negative inserts

Application	Chip breaker	Features	Chip breaker range	Cross section geometry 
Finishing	<p>PB1</p> 	<p>First choice for steel finish turning Light cutting chip breaker, low cutting force, suitable for machining slender shaft, thin wall and unstable clamping parts, good cutting performance</p>		
	<p>MB2</p> 	<p>First choice for stainless steel finish turning High positive rake angle reduced cutting force and built-up edge, can obtain much better surface quality. Very good chip breaking at low feed and cutting depth.</p>		
Semifinishing	<p>PB3</p> 	<p>First choice for steel semi finish turning The positive rake angle combined with small land guaranteed edge strength and sharpness, reduced the cutting force. The wavy side edge design has a good chip breaking result in out-copying turning on the shoulder, and in profile turning at different cutting depths</p>		
	<p>PC3</p> 	<p>Alternative chipbreaker for steel semi-finish turning Unique geometry design offers wider chip breaking range. Double rake angle makes the cutting smoothly. Enhanced insert tip reduced crater wear.</p>		
Medium	<p>PD3</p> 	<p>First choice for steel medium turning It has a strong chip control ability at low feed and cutting depth, and reduces crater wear. The chip breaking is also very good at high feed and cutting depth due to the geometry design. Double rake angle design makes sharp cutting edge and reduces cutting force.</p>		
	<p>PC4</p> 	<p>First choice for cast iron medium turning Alternative chipbreaker for carbon steel and alloy steel medium turning Flat T-land guarantee the strength of cutting edge. This multi-purpose geometry can be used in universal applications.</p>		
	<p>PL5</p> 	<p>First choice for steel slender shaft turning Open chip breaker leads to smooth cutting with low cutting force, which is suitable for slender shaft turning.</p>		

						
<p>CNMG-PB1</p>  <p>P38</p>	<p>DNMG-PB1</p>  <p>P42</p>	<p>SNMG-PB1</p>  <p>P45</p>	<p>TNMG-PB1</p>  <p>P48</p>	<p>VNMG-PB1</p>  <p>P51</p>	<p>WNMG-PB1</p>  <p>P52</p>	
<p>CNMG-MB2</p>  <p>P38</p>	<p>DNMG-MB2</p>  <p>P42</p>	<p>SNMG-MB2</p>  <p>P45</p>	<p>TNMG-MB2</p>  <p>P48</p>	<p>VNMG-MB2</p>  <p>P51</p>	<p>WNMG-MB2</p>  <p>P52</p>	
<p>CNMG-PB3</p>  <p>P38</p>	<p>DNMG-PB3</p>  <p>P42</p>		<p>TNMG-PB3</p>  <p>P48</p>	<p>VNMG-PB3</p>  <p>P51</p>	<p>WNMG-PB3</p>  <p>P52</p>	
<p>CNMG-PC3</p>  <p>P38</p>	<p>DNMG-PC3</p>  <p>P42</p>	<p>SNMG-PC3</p>  <p>P45</p>	<p>TNMG-PC3</p>  <p>P48</p>	<p>VNMG-PC3</p>  <p>P51</p>	<p>WNMG-PC3</p>  <p>P52</p>	
<p>CNMG-PD3</p>  <p>P38</p>	<p>DNMG-PD3</p>  <p>P42</p>	<p>SNMG-PD3</p>  <p>P45</p>	<p>TNMG-PD3</p>  <p>P48</p>	<p>VNMG-PD3</p>  <p>P51</p>	<p>WNMG-PD3</p>  <p>P52</p>	
<p>CNMG-PC4</p>  <p>P39</p>	<p>DNMG-PC4</p>  <p>P43</p>	<p>SNMG-PC4</p>  <p>P46</p>	<p>TNMG-PC4</p>  <p>P49</p>	<p>VNMG-PC4</p>  <p>P51</p>	<p>WNMG-PC4</p>  <p>P53</p>	
			<p>TNMG-PL5</p>  <p>P48</p>			

Turning inserts



Application	Chip breaker	Features	Chip breaker range	Cross section geometry 
Medium	<p>SC3</p> 	<p>First choice for high temperature alloy medium turning Used in medium turning high temperature alloy and titanium alloy. Large rake angle + small land width design, easy cutting, also suitable in soft steel turning.</p>		
	<p>MC3</p> 	<p>First choice for stainless steel medium turning Sharp cutting edge, low cutting force, wide chip breaking range and chip removal ability</p>		
Roughing	<p>PD5</p> 	<p>Alternative chipbreaker for steel rough turning A strong cutting edge. Double rake angle design effectively reduces the cutting force, can still have good chip breaking at small cutting depth.</p>		
	<p>MC4</p> 	<p>Alternative chipbreaker for stainless steel and superalloy rough turning Large chip breaker design, smooth chip evacuation, good chip breaking, with high metal removal rate.</p>		
	<p>KC4</p> 	<p>First choice for cast iron rough turning It has strong cutting edge, reliable and stable performance.</p>		
	<p>KD5</p> 	<p>First choice for cast iron rough turning High cutting edge strength, suitable for interrupt cutting and unstable cutting</p>		
Heavy roughing	<p>PC8</p> 	<p>Light cutting geometry for heavy turning Positive rake angle and curved cutting edge design, low cutting force</p>		
	<p>PD8</p> 	<p>Heavy turning geometry for soft steel and stainless steel The geometry design ensures low cutting force. Suitable for low power machine tools. Applied in steel, stainless steel and cast iron heavy turning.</p>		



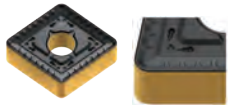
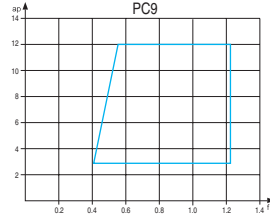
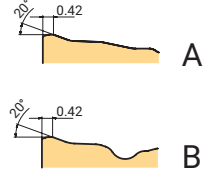
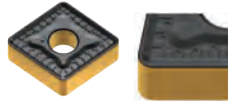
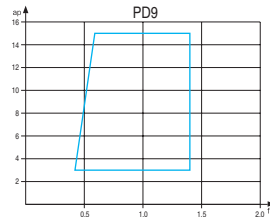
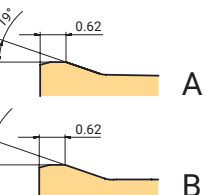

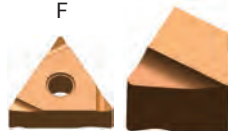
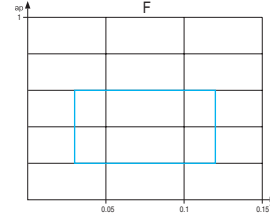

						
CNMG-SC3  P39	DNMG-SC3  P43	SNMG-SC3  P45	TNMG-SC3  P48	VNMG-SC3  P51	WNMG-SC3  P52	
CNMG-MC3  P39	DNMG-MC3  P43	SNMG-MC3  P45	TNMG-MC3  P49	VNMG-MC3  P51	WNMG-MC3  P52	
CNMG-PD5  P40	DNMG-PD5  P44	SNMG-PD5  P46	TNMG-PD5  P50		WNMG-PD5  P53	
CNMG-MC4  P39	DNMG-MC4  P43	SNMG-MC4  P46	TNMG-MC4  P49		WNMG-MC4  P53	
CNMG-KC4  P40	DNMG-KC4  P44	SNMG-KC4  P46	TNMG-KC4  P49	VNMG-KC4  P51	WNMG-KC4  P53	
CNMA-KD5  P40	DNMA-KD5  P44	SNMA-KD5  P47	TNMA-KD5  P50		WNMA-KD5  P53	
CNMM-PC8  P41						
CNMM-PD8  P41		SNMM-PD8  P47	TNMM-PD8  P50			

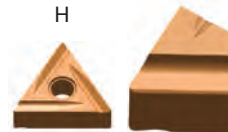
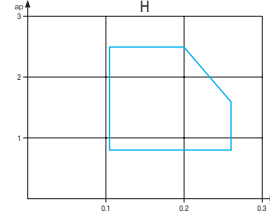
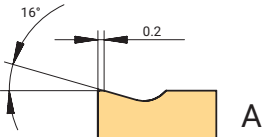





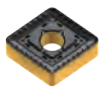
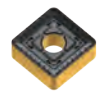
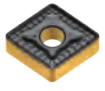
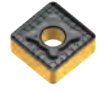

Turning inserts

Application	Chip breaker	Features	Chip breaker range	Cross section geometry 
Heavy roughing	<p>PC9</p> 	<p>First choice for steel heavy turning Wavy geometry is good for chip breaking. The geometry has a big space for chips, which is suitable for high metal removal rate.</p>		
	<p>PD9</p> 	<p>Alternative chipbreaker for steel heavy turning High edge strength is suitable for big cutting depth and high feed turning. High machining reliability.</p>		

Negative ground insert











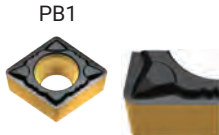
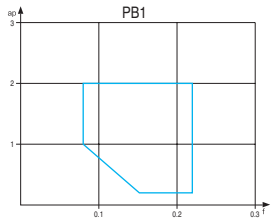



Application	Chip breaker	Features	Chip breaker range	Cross section geometry 
Finishing	<p>F</p> 	<p>Finishing turning Low cutting force, good chip control. The sharp edge produces a good surface finish.</p>		
Semifinishing-roughing	<p>H</p> 	<p>Light turning Excellent chip control at low to medium feed rates. Strong edge strength.</p>		

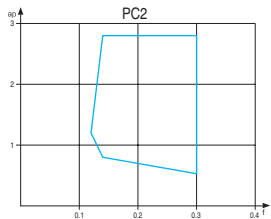
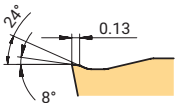

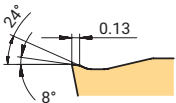

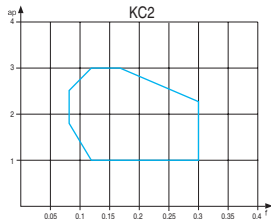
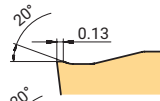
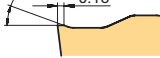
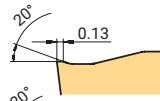
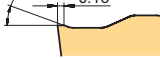
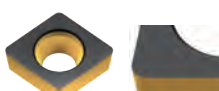
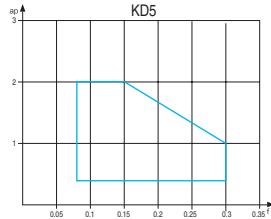

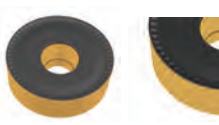
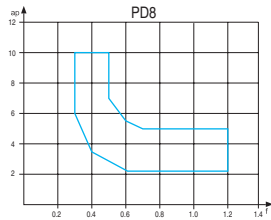
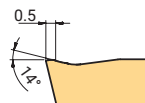











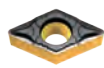
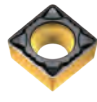

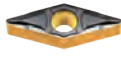







						
CNMM-PC9  P41		SNMM-PC9  P47				
CNMM-PD9  P41		SNMM-PD9  P47				

						
			TNGG-F  P50			
			TNGG-H  P50			









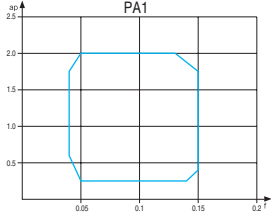

Overview of Turning Insert Geometries

Positive inserts

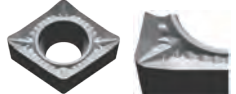
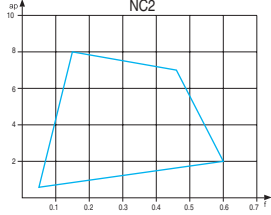
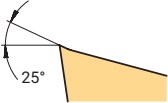
Application	Chip breaker	Features	Chip breaker range	Cross section geometry 
Finishing	 <p>PB1</p>	<p>First choice for steel finish turning Positive rake angle reduces cutting force and built-up edge, and obtains better surface finish and longer tool life. Also can be used in stainless steel turning.</p>		 A  B
				 A  B
Semifinishing	 <p>PC2</p>	<p>First choice for steel and stainless steel semi-finish turning Sharp geometry design ensures low cutting force, less built-up edge and excellent chip control.</p>		 A  B
				 A  B
Medium	 <p>KC2</p>	<p>General purpose geometry for steel, stainless steel and cast iron turning Suitable for medium and rough turning. Simple and durable chip breaker design, very good versatility and wide application range.</p>		 A  B
				 A  B
Roughing	 <p>KD5</p>	<p>Geometry for cast iron rough turning Suitable for unstable machining due to its strong cutting edge. Reduced chipping.</p>		 A
				 <p>HT</p>
Medium	 <p>PD8</p>	<p>Geometry for carbon steel and alloy steel heavy turning A wide chipbreaker avoid chip jam at big cutting depth. Chip control can be also good at small cutting depth.</p>		 A
				 <p>No code</p>

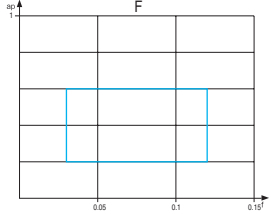
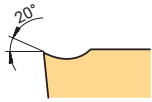
						
<p>CCMT-PB1</p>  <p>P55</p>	<p>DCMT-PB1</p>  <p>P58</p>	<p>SCMT-PB1</p>  <p>P61</p>	<p>TNMG-PB1</p>  <p>P62</p>	<p>VNMG-PB1</p>  <p>P65</p>		
<p>CCMT-PC2</p>  <p>P55</p>	<p>DCMT-PC2</p>  <p>P58</p>	<p>SCMT-PC2</p>  <p>P61</p>	<p>TCMT-PC2</p>  <p>P62</p>	<p>VBMT-PC2 VCMT-PC2</p>  <p>P65</p>		
<p>CCMT-KC2</p>  <p>P56</p>	<p>DCMT-KC2</p>  <p>P59</p>	<p>SCMT-KC2</p>  <p>P61</p>	<p>TCMT-KC2</p>  <p>P63</p>	<p>VBMT-KC2</p>  <p>P66</p>		
<p>CCMW-KD5</p>  <p>P56</p>	<p>DCMW-KD5</p>  <p>P59</p>	<p>SCMW-KD5</p>  <p>P61</p>	<p>TCMW-KD5</p>  <p>P63</p>			
		<p>SCMT-HT</p>  <p>P61</p>				
						<p>RCMX-PD8</p>  <p>P69</p>
						<p>RCMX</p>  <p>P69</p>

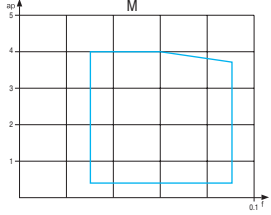
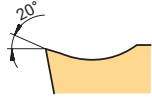
Positive ground inserts

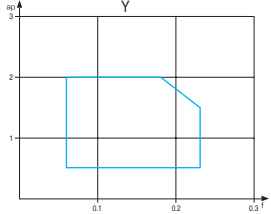
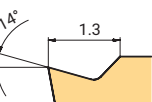
Application	Chip breaker	Features	Chip breaker range	Cross section geometry 
Finishing	<p>UF</p> 	<p>First choice for high temperature alloy turning Peripheral ground finish turning inserts. High repeatability on insert positioning. Sharp cutting edge can achieve good machining tolerance.</p>		 A
				 B
Semifinishing	<p>NC2</p> 	<p>Choice for aluminium alloy turning Very positive rake angle is designed for non-ferrous metal finish and semi-finish turning. It reduces the cutting force and make smooth chip evacuation. The polished rake surface, with reduced friction and built-up edge.</p>		 A  B
Finishing	<p>F</p> 	<p>Choice for finish turning Excellent chip control at low feed rates. Very low cutting force.</p>		 A
Low feed	<p>M</p> 	<p>Geometry for low feed turning in automatic lathe Excellent chip control at low to medium feed rates. Reliable machining. Big rake angle avoid work hardening.</p>		 A
	<p>Y</p> 	<p>Choice for Semi finish-rough turning in automatic lathe The strong edge can be used in rough turning. Good chip control for low to medium feed rate</p>		 A

						
<p>CCGT-UF</p>  <p>P55</p>	<p>DCGT-UF</p>  <p>P58</p>		<p>TCGT-UF</p>  <p>P62</p>	<p>VBGT-UF VCGT-UF</p>  <p>P65</p>		
<p>CCGT-NC2</p>  <p>P55</p>	<p>DCGT-NC2</p>  <p>P58</p>	<p>SCGT-NC2</p>  <p>P61</p>	<p>TCGT-NC2</p>  <p>P62</p>	<p>VCGT-NC2</p>  <p>P66</p>		<p>RCGT-NC2</p>  <p>P69</p>
<p>CCET-F</p>  <p>P56</p>	<p>DCET-F</p>  <p>P59</p>		<p>TBET-F TPEH-F</p>  <p>P64</p>	<p>VBET-F VCET-F VPET-F</p>  <p>P66, 67</p>	<p>WBRT-F</p>  <p>P68</p>	
<p>CCET-M</p>  <p>P57</p>	<p>DCET-M</p>  <p>P60</p>		<p>TCET-M</p>  <p>P64</p>	<p>VBET-M VPET-M</p>  <p>P66, 67</p>		
				<p>VBET-Y</p>  <p>P67</p>		

Grade Application Guide

Turning grade application for ISO material group												
Material Group	Materials	ISO	CVD coated					PVD coated		Uncoated	ISO	
			AC150P	AC200P	AC250P	AC350P	ACK15A	AC150K	AP301M			AP100S
P	Unalloyed steels / Alloyed steels	P01										P01
		P05										P05
		P10	AC150P									P10
		P15		AC200P								P15
		P20			AC250P							P20
		P25				AC350P						P25
		P30										P30
		P35										P35
		P40										P40
		P45										P45
		P50										P50
M	Stainless steels	M01										M01
		M05										M05
		M10										M10
		M15								AP100S		M15
		M20										M20
		M25							AP301M			M25
		M30										M30
		M35										M35
		M40										M40
		M45										M45
K	Cast iron	K01										K01
		K05										K05
		K10										K10
		K15										K15
		K20						ACK15A	AC150K			K20
		K25										K25
		K30										K30
		K35										K35
		K40										K40
		K45										K45
		K50										K50
S	Heat resistant alloy	S01										S01
		S05										S05
		S10										S10
		S15								AP100S		S15
		S20										S20
		S25							AP301M			S25
		S30										S30
		S35										S35
		S40										S40
N	Aluminum/ Aluminum alloys	N01										N01
		N05										N05
		N10										N10
		N15									AW100K	N15
		N20										N20
		N25										N25
		N30										N30
H	Hardened steels/ Chilled cast iron	H01										H01
		H05										H05
		H10										H10
		H15										H15
		H20										H20
		H25										H25
H30										H30		

Turning Grade Description

AC150P

Coating: CVD coating

The ultra-fine crystal substrate combined with MTCVD TiCN coating, and plus a thick layer of α -Al₂O₃ coating offers excellent wear resistance to extend tool life under high speed continuous or slight interrupted cutting.



Turning inserts

Application range											
ISO Classification	01	05	10	15	20	25	30	35	40	45	50
P		AC150P									
M											
K											
S											
N											
H											

Remark: Best choice

AC200P

Coating: CVD coating

The thickened ultra-fine crystal MTCVD TiCN coating and columnar α -Al₂O₃ coating has higher wear resistance and toughness, and can obtain longer tool life and better stability.

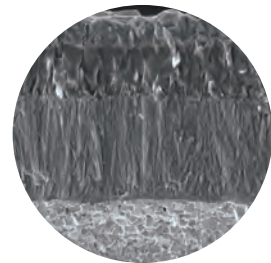

Application range											
ISO Classification	01	05	10	15	20	25	30	35	40	45	50
P			AC200P								
M											
K											
S											
N											
H											

Remark: Best choice

AC250P

Coating: CVD coating

Cobalt enriched tough substrate with MTCVD TiCN and Al₂O₃ coating provides excellent wear resistance and chipping resistance. Very good versatility.



Application range											
ISO Classification	01	05	10	15	20	25	30	35	40	45	50
P					AC250P						
M											
K											
S											
N											
H											

Remark: Best choice

AC350P

Coating: CVD coating

For rough turning steel. Very tough cobalt enriched substrate with specific coating. Excellent performance in interrupted cutting.

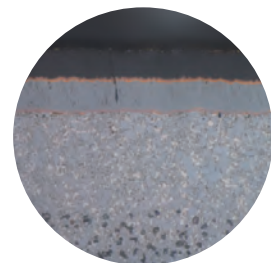

Application range											
ISO Classification	01	05	10	15	20	25	30	35	40	45	50
P							AC350P				
M											
K											
S											
N											
H											

Remark: Best choice

ACK15A

Coating: CVD coating

Very good performance in cast iron medium and rough turning. Good for continuous and interrupted cutting.

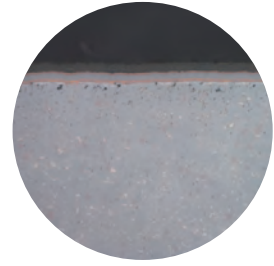

Application range											
ISO Classification	01	05	10	15	20	25	30	35	40	45	50
P											
M											
K			ACK15A								
S											
N											
H											

Remark: Best choice

AC150K

Coating: CVD coating

Suitable for cast iron semi finish and medium turning. New thicker CVD coating on ultra-fine crystal substrate, with optimized coating structure and adhesive strength, and polished smooth coating surface, result in good wear resistance and chipping resistance.

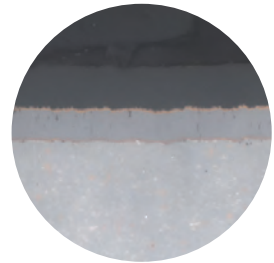

Application range											
ISO Classification	01	05	10	15	20	25	30	35	40	45	50
P											
M											
K			AC150K								
S											
N											
H											

Remark: Best choice

Turning inserts

AP301M

Coating: PVD coating

For stainless steel semi finish and medium turning. Tough and good wear resistance substrate with nanostructured PVD coating, provides better machining stability and longer tool life.

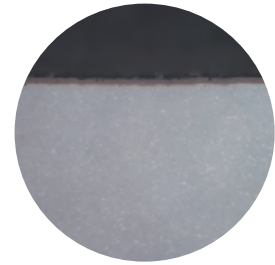

Application range											
ISO Classification	01	05	10	15	20	25	30	35	40	45	50
P											
M				AP301M							
K											
S				AP301M							
N											
H											

Remark: Best choice
 2nd choice

AP100S

Coating: PVD coating

For heat resistant alloy turning. Ultra-fine grain substrate and nanostructured PVD coating provide strong adhesive strength and anti oxidation, and result in longer tool life.

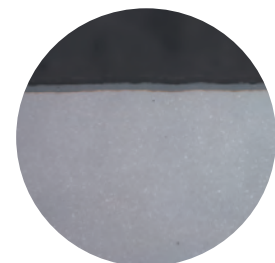

Application range											
ISO Classification	01	05	10	15	20	25	30	35	40	45	50
P											
M		AP100S									
K											
S		AP100S									
N											
H											

Remark: Best choice
 2nd choice

AW100K

Coating: Uncoated

For nonferrous alloy turning. Fine grain size substrate, uncoated, with special edge preparation.

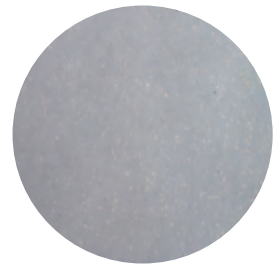

Turning inserts

Application range											
ISO Classification	01	05	10	15	20	25	30	35	40	45	50
P											
M											
K											
S											
N		AW100K									
H											

Remark: Best choice

Negative 80° (C) Rhombic Inserts

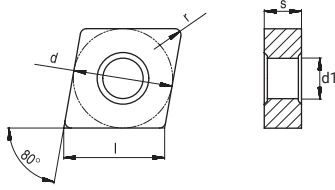

Dimensions (mm)				
Type	d	l	s	d1
CN_1204_	12.7	12.9	4.76	5.16
CN_1606_	15.87	16.1	6.35	6.35
CN_1906_	19.05	19.3	6.35	7.94

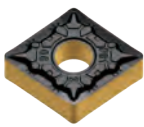
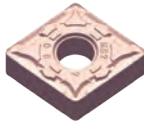
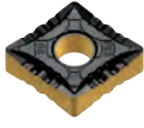
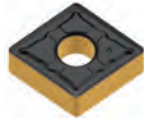
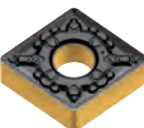
Inserts	Type	r (mm)	Recommended parameters		Grades										
			f (mm/rev)	ap (mm)	AC150P	AC200P	AC250P	AC350P	AP301M	AC150K	ACK15A	AW100K	AP100S		
Finishing	 CNMG 120404E-PB1 120408E-PB1 120412E-PB1	0.4	0.05-0.15	0.26-3.2	●	○	●								
		0.8	0.10-0.30	0.52-3.2	●	○	●								
		1.2	0.15-0.45	0.78-3.2	●	○	○								
	 CNMG 120404E-MB2 120408E-MB2	0.4	0.05-0.15	0.26-3.2					●					●	
		0.8	0.10-0.30	0.52-3.2					●					●	
	Semifinishing	 CNMG 120404E-PB3 120408E-PB3 120412E-PB3	0.4	0.06-0.18	0.30-3.5	●	○	●							
0.8			0.12-0.36	0.60-3.5	●	○	●								
1.2			0.18-0.54	0.90-3.5	●	○	○								
 CNMG 120404E-PC3 120408E-PC3 120412E-PC3 190608E-PC3 190612E-PC3		0.4	0.07-0.20	0.34-3.9	○	○	●								
		0.8	0.14-0.40	0.68-3.9	●	●	●								
		1.2	0.20-0.60	1.02-3.9	○	○	●								
		0.8	0.14-0.40	0.68-5.8	○	○	○								
		1.2	0.20-0.60	1.02-5.8	○	○	○								
Medium	 CNMG 120404E-PD3 120408E-PD3 120412E-PD3 160608E-PD3 160612E-PD3 190608E-PD3	0.4	0.08-0.22	0.40-4.3	●	●	●	○							
		0.8	0.15-0.44	0.80-4.3	●	●	●	●							
		1.2	0.23-0.66	1.20-4.3	●	●	●	●							
		0.8	0.15-0.44	0.80-5.3	●	○	●	○							
		1.2	0.23-0.66	1.20-5.3	●	●	●	○							
		0.8	0.15-0.44	0.80-6.4	○	○	●	○							

Marked : ● Stock available ○ Non-stocked standard

Negative 80° (C) Rhombic Inserts

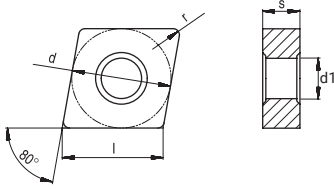

Dimensions (mm)				
Type	d	l	s	d1
CN_1204_	12.7	12.9	4.76	5.16
CN_1606_	15.87	16.1	6.35	6.35
CN_1906_	19.05	19.3	6.35	7.94

Inserts	Type	r (mm)	Recommended parameters		Grades									
			f (mm/rev)	ap (mm)	AC150P	AC200P	AC250P	AC350P	AP301M	AC150K	ACK15A	AW100K	APT100S	
Medium		CNMG 120404E-SC3	0.4	0.08-0.22	0.40-4.3									●
		120408E-SC3	0.8	0.15-0.44	0.80-4.3					○				●
		120412E-SC3	1.2	0.23-0.66	1.20-4.3					○				●
		160612E-SC3	1.2	0.23-0.66	1.20-5.3					○				●
		160616E-SC3	1.6	0.30-0.88	1.60-5.3									○
		190612E-SC3	1.2	0.23-0.66	1.20-6.4									●
	190616E-SC3	1.6	0.30-0.88	1.60-6.4									○	
		CNMG 120404E-MC3	0.4	0.08-0.22	0.32-4.3					●				○
		120408E-MC3	0.8	0.15-0.44	0.64-4.3					●				●
		120412E-MC3	1.2	0.23-0.66	0.96-4.3					●				○
		120416E-MC3	1.6	0.30-0.88	1.28-4.3					○				
		160608E-MC3	0.8	0.15-0.44	0.64-5.3					○				
		160612E-MC3	1.2	0.23-0.66	0.96-5.3					○				
		190608E-MC3	0.8	0.15-0.44	0.64-6.4					○				
		190612E-MC3	1.2	0.23-0.66	0.96-6.4					○				
		CNMG 120404E-PC4	0.4	0.08-0.22	0.40-4.3	○		●	○		○	●		
		120408E-PC4	0.8	0.15-0.44	0.80-4.3	●		●	○		●	●		
		120412E-PC4	1.2	0.23-0.66	1.20-4.3	●		●	○		○	●		
160612E-PC4		1.2	0.23-0.66	1.20-5.3	○		●	○		○	○			
	160616E-PC4	1.6	0.30-0.88	1.60-5.3	○		○	○		○	●			
	190612E-PC4	1.2	0.23-0.66	1.20-6.4	○		●			○	○			
		CNMG 120408E-MC4	0.8	0.20-0.60	1.20-6.4					●				●
		120412E-MC4	1.2	0.30-0.90	1.80-6.4					●				●
		160612E-MC4	1.2	0.30-0.90	1.80-8.1					●				○
		160616E-MC4	1.6	0.40-1.20	2.40-8.1					○				○
190612E-MC4		1.2	0.30-0.90	1.80-9.7					●					
190616E-MC4		1.6	0.40-1.20	2.40-9.7					●					

Marked : ● Stock available ○ Non-stocked standard

Turning inserts

Negative 80° (C) Rhombic Inserts

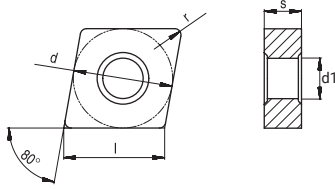

Dimensions (mm)				
Type	d	l	s	d1
CN_0903_	9.52	9.67	3.18	3.81
CN_1204_	12.7	12.9	4.76	5.16
CN_1606_	15.87	16.1	6.35	6.35
CN_1906_	19.05	19.3	6.35	7.94

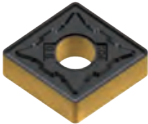
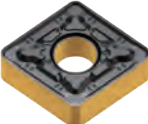
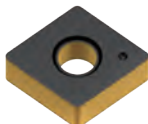
Inserts	Type	r (mm)	Recommended parameters		Grades												
			f (mm/rev)	ap (mm)	AC150P	AC200P	AC250P	AC350P	AP301M	AC150K	ACK15A	AW100K	APT100S				
Roughing		CNMG 090308E-KC4	0.8	0.18-0.48	0.96-3.9						○	○					
		120404E-KC4	0.4	0.09-0.24	0.48-5.2						○	●					
		120408E-KC4	0.8	0.18-0.48	0.96-5.2						●	●					
		120412E-KC4	1.2	0.26-0.72	1.44-5.2						●	●					
		120416E-KC4	1.6	0.35-0.96	1.92-5.2						●	○					
		160608E-KC4	0.8	0.18-0.48	0.96-6.4						○	○					
		160612E-KC4	1.2	0.26-0.72	1.44-6.4						●	●					
		160616E-KC4	1.6	0.35-0.96	1.92-6.4						○	●					
		190608E-KC4	0.8	0.18-0.48	0.96-7.7						○	○					
		190612E-KC4	1.2	0.26-0.72	1.44-7.7						○	●					
		190616E-KC4	1.6	0.35-0.96	1.92-7.7						○	●					
	190624E-KC4	2.4	0.53-1.44	2.88-7.7						○	○						
		CNMG 120408E-PD5	0.8	0.20-0.60	1.20-6.4	●		●	●								
		120412E-PD5	1.2	0.30-0.90	1.80-6.4	●		●	○								
		160612E-PD5	1.2	0.30-0.90	1.80-8.1	●	●	●	●								
		160616E-PD5	1.6	0.40-1.20	2.40-8.1	●		●	○								
		160624E-PD5	2.4	0.60-1.80	3.60-8.1			○	○								
		190612E-PD5	1.2	0.30-0.90	1.80-9.7	●		●	○								
		190616E-PD5	1.6	0.40-1.20	2.40-9.7	○	●	●	●								
		CNMA 120404E-KD5	0.4	0.10-0.30	0.60-6.4						○	○					
		120408E-KD5	0.8	0.20-0.60	1.20-6.4						●	●					
		120412E-KD5	1.2	0.30-0.90	1.80-6.4						●	●					
		120416E-KD5	1.6	0.40-1.20	2.40-6.4						○	○					
		160608E-KD5	0.8	0.20-0.60	1.20-8.1						○	○					
		160612E-KD5	1.2	0.30-0.90	1.80-8.1						○	○					
		160616E-KD5	1.6	0.40-1.20	2.40-8.1						●	○					
		160620E-KD5	2.0	0.50-1.50	3.00-8.1						●	○					
		190608E-KD5	0.8	0.20-0.60	1.20-9.7						○	○					
		190612E-KD5	1.2	0.30-0.90	1.80-9.7						○	○					
		190616E-KD5	1.6	0.40-1.20	2.40-9.7						○	●					

Marked : ● Stock available ○ Non-stocked standard

Negative 80° (C) Rhombic Inserts

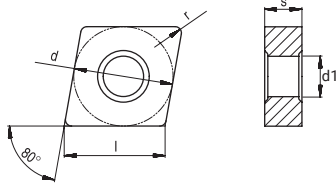

Dimensions (mm)				
Type	d	l	s	d1
CN_1204_	12.7	12.9	4.76	5.16
CN_1606_	15.87	16.1	6.35	6.35
CN_1906_	19.05	19.3	6.35	7.94
CN_2507_	25.4	25.8	7.94	9.12
CN_2509_	25.4	25.8	9.53	9.12

Inserts	Type	r (mm)	Recommended parameters		Grades								
			f (mm/rev)	ap (mm)	AC150P	AC200P	AC250P	AC350P	AP301M	AC150K	ACK15A	AW100K	AP100S
	CNMM 190616E-PC8	1.6	0.32-0.64	2.88-7.7	○	○	○						
	190624E-PC8	2.4	0.48-0.96	4.32-7.7	○	○	○						
	CNMM 120408E-PD8	0.8	0.16-0.32	1.44-5.2	●		○	○					
	120412E-PD8	1.2	0.24-0.48	2.16-5.2	○		○	○					
	160612E-PD8	1.2	0.24-0.48	2.16-6.4	○		●	○					
	160616E-PD8	1.6	0.32-0.64	2.88-6.4	○		●	○					
	160624E-PD8	2.4	0.48-0.96	4.32-6.4	○		○	○					
	190612E-PD8	1.2	0.24-0.48	2.16-7.7	○		○	○					
	190616E-PD8	1.6	0.32-0.64	2.88-7.7	○		○	●					
	190624E-PD8	2.4	0.48-0.96	4.32-7.7	○		○	○					
	250724E-PD8	2.4	0.48-0.96	4.32-10.3	○		○	○					
250924E-PD8	2.4	0.48-0.96	4.32-10.3	○		○	○						
	CNMM 190612S-PC9	1.2	0.26-0.60	2.40-9.7	○		○	○					
	190616S-PC9	1.6	0.35-0.80	3.20-9.7	○		○	○					
	190624S-PC9	2.4	0.53-1.20	4.80-9.7	○		○	○					
	250724S-PC9	2.4	0.53-1.20	4.80-12.9	○		○	○					
	250924S-PC9	2.4	0.53-1.20	4.80-12.9	○		●	○					
	CNMM 190612S-PD9	1.2	0.30-0.72	2.64-11.6	○		○	○					
	190616S-PD9	1.6	0.40-0.96	3.52-11.6	●	○	●	○					
	190624S-PD9	2.4	0.60-1.44	5.28-11.6	○		●	○					
	250724S-PD9	2.4	0.60-1.44	5.28-15.5	○		○	○					
	250924S-PD9	2.4	0.60-1.44	5.28-15.5	○	○	●	●					

Marked : ● Stock available ○ Non-stocked standard

Turning inserts

Negative 55° (D) Rhombic Inserts

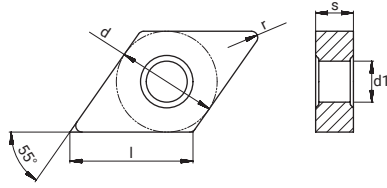

Dimensions (mm)				
Type	d	l	s	d1
DN_1104_	9.52	11.62	4.76	3.81
DN_1504_	12.7	15.5	4.76	5.16
DN_1506_	12.7	15.5	6.35	5.16

Inserts	Type	r (mm)	Recommended parameters		Grades												
			f (mm/rev)	ap (mm)	AC150P	AC200P	AC250P	AC350P	AP301M	AC150K	ACK15A	AW100K	APT100S				
Finishing		DNMG 110404E-PB1	0.4	0.05-0.15	0.26-2.3	○		●									
		150404E-PB1	0.4	0.05-0.15	0.26-3.1	●	○	●									
		150408E-PB1	0.8	0.10-0.30	0.52-3.1	●	○	●									
		150604E-PB1	0.4	0.05-0.15	0.26-3.1	●	○	○									
	150608E-PB1	0.8	0.10-0.30	0.52-3.1	●	○	●										
		DNMG 150404E-MB2	0.4	0.05-0.15	0.26-2.9					○							●
		150408E-MB2	0.8	0.10-0.30	0.52-2.9					○							○
		150604E-MB2	0.4	0.05-0.15	0.26-2.9					●							●
150608E-MB2		0.8	0.10-0.30	0.52-2.9					○							●	
Semifinishing		DNMG 150404E-PB3	0.4	0.06-0.18	0.30-3.1	○	○	○									
		150408E-PB3	0.8	0.12-0.36	0.60-3.1	●	○	○									
		150412E-PB3	1.2	0.18-0.54	0.90-3.1	○	○	○									
		150604E-PB3	0.4	0.06-0.18	0.30-3.1	●	○	●									
		150608E-PB3	0.8	0.12-0.36	0.60-3.1	●	○	●									
		150612E-PB3	1.2	0.18-0.54	0.90-3.1	○	○	○									
		DNMG 110408E-PC3	0.8	0.14-0.40	0.68-2.6	●	○	○									
		110412E-PC3	1.2	0.20-0.60	1.02-2.6	○	○	○									
		150404E-PC3	0.4	0.07-0.20	0.34-3.5	○	○	○									
		150408E-PC3	0.8	0.14-0.40	0.68-3.5	●	○	●									
		150412E-PC3	1.2	0.20-0.60	1.02-3.5	○	○	○									
		150604E-PC3	0.4	0.07-0.20	0.34-3.5	○	○	●									
		150608E-PC3	0.8	0.14-0.40	0.68-3.5	●	●	●									
		150612E-PC3	1.2	0.20-0.60	1.02-3.5	○	○	○									
Medium		DNMG 110404E-PD3	0.4	0.08-0.22	0.40-2.9	○	○	○									
		110408E-PD3	0.8	0.15-0.44	0.80-2.9	●	○	●									
		150404E-PD3	0.4	0.08-0.22	0.40-3.9	○	●	●									
		150408E-PD3	0.8	0.15-0.44	0.80-3.9	●	●	●	○								
		150412E-PD3	1.2	0.23-0.66	1.20-3.9	●	○	●	○								
		150604E-PD3	0.4	0.08-0.22	0.40-3.9	●	○	●									
		150608E-PD3	0.8	0.15-0.44	0.80-3.9	●	●	●	●								
		150612E-PD3	1.2	0.23-0.66	1.20-3.9	○	●	●	○								

Marked : ● Stock available ○ Non-stocked standard

Negative 55° (D) Rhombic Inserts

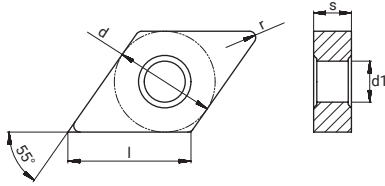

Dimensions (mm)				
Type	d	l	s	d1
DN_1104_	9.52	11.62	4.76	3.81
DN_1504_	12.7	15.5	4.76	5.16
DN_1506_	12.7	15.5	6.35	5.16

Inserts	Type	r (mm)	Recommended parameters		Grades										
			f (mm/rev)	ap (mm)	AC150P	AC200P	AC250P	AC350P	AP301M	AC150K	ACK15A	AW100K	AP100S		
Medium		DNMG 150404E-SC3	0.4	0.08-0.22	0.40-3.9										●
		150408E-SC3	0.8	0.15-0.44	0.80-3.9										●
		150412E-SC3	1.2	0.23-0.66	1.20-3.9										○
		150604E-SC3	0.4	0.08-0.22	0.40-3.9										●
		150608E-SC3	0.8	0.15-0.44	0.80-3.9										●
		150612E-SC3	1.2	0.23-0.66	1.20-3.9										○
		DNMG 110404E-MC3	0.4	0.08-0.22	0.32-2.9					●					
		110408E-MC3	0.8	0.15-0.44	0.64-2.9					○					
		150404E-MC3	0.4	0.08-0.22	0.32-3.9					●					
		150408E-MC3	0.8	0.15-0.44	0.64-3.9					●					
		150412E-MC3	1.2	0.23-0.66	0.96-3.9					○					
		150604E-MC3	0.4	0.08-0.22	0.32-3.9					●					
		DNMG 150404E-PC4	0.4	0.08-0.22	0.40-3.9	○		○			○	○			
		150408E-PC4	0.8	0.15-0.44	0.80-3.9	○		●			○	●			
		150412E-PC4	1.2	0.23-0.66	1.20-3.9	○		○			○	●			
		150604E-PC4	0.4	0.08-0.22	0.40-3.9	○		○			○	○			
		150608E-PC4	0.8	0.15-0.44	0.80-3.9	●		○			●	●			
		150612E-PC4	1.2	0.23-0.66	1.20-3.9	●		○			○	○			
Roughing		DNMG 150408E-MC4	0.8	0.20-0.60	1.20-5.4					○				○	
		150412E-MC4	1.2	0.30-0.90	1.80-5.4					○				○	
		150608E-MC4	0.8	0.20-0.60	1.20-5.4					○				○	
		150612E-MC4	1.2	0.30-0.90	1.80-5.4					○				○	

Marked : ● Stock available ○ Non-stocked standard

Turning inserts

Negative 55° (D) Rhombic Inserts

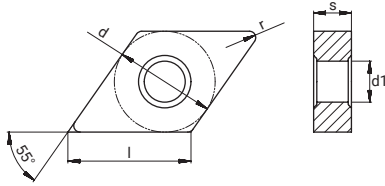

Dimensions (mm)				
Type	d	l	s	d1
DN_1104_	9.52	11.62	4.76	3.81
DN_1504_	12.7	15.5	4.76	5.16
DN_1506_	12.7	15.5	6.35	5.16

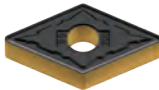
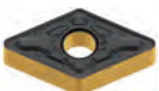
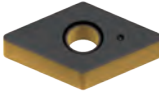

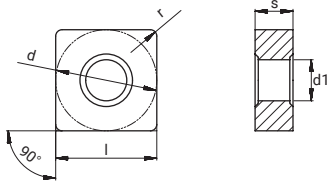

Inserts	Type	r (mm)	Recommended parameters		Grades														
			f (mm/rev)	ap (mm)	AC150P	AC200P	AC250P	AC350P	AP301M	AC150K	ACK15A	AW100K	AP100S						
Roughing		DNMG 110404E-KC4	0.4	0.09-0.24	0.48-3.5														
		110408E-KC4	0.8	0.18-0.48	0.96-3.5														
		150404E-KC4	0.4	0.09-0.24	0.48-4.6														
		150408E-KC4	0.8	0.18-0.48	0.96-4.6														
		150412E-KC4	1.2	0.26-0.72	1.44-4.6														
		150604E-KC4	0.4	0.09-0.24	0.48-4.6														
		150608E-KC4	0.8	0.18-0.48	0.96-4.6														
		150612E-KC4	1.2	0.26-0.72	1.44-4.6														
		DNMG 150408E-PD5	0.8	0.20-0.60	1.20-5.4	○	○	●	○										
		150412E-PD5	1.2	0.30-0.90	1.80-5.4	○	○	●	○										
		150416E-PD5	1.6	0.40-1.20	2.40-5.4	○	○	●	○										
		150608E-PD5	0.8	0.20-0.60	1.20-5.4	○	○	○	●										
		150612E-PD5	1.2	0.30-0.90	1.80-5.4	●	○	●	○										
		150616E-PD5	1.6	0.40-1.20	2.40-5.4	○	○	●	○										
		DNMA 150404E-KD5	0.4	0.10-0.30	0.60-5.4														
		150408E-KD5	0.8	0.20-0.60	1.20-5.4														
		150412E-KD5	1.2	0.30-0.90	1.80-5.4														
		150604E-KD5	0.4	0.10-0.30	0.60-5.4														
		150608E-KD5	0.8	0.20-0.60	1.20-5.4														
		150612E-KD5	1.2	0.30-0.90	1.80-5.4														

Marked : ● Stock available ○ Non-stocked standard

Negative 55° (D) Rhombic Inserts

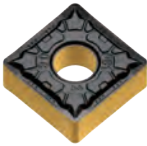

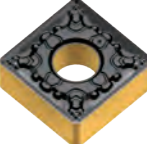
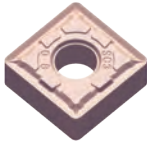
Dimensions (mm)				
Type	d	l	s	d1
SN_1204_	12.7	12.7	4.76	5.16
SN_1506_	15.87	15.87	6.35	6.35
SN_1906_	19.05	19.05	6.35	7.94

Inserts	Type	r (mm)	Recommended parameters		Grades									
			f (mm/rev)	ap (mm)	AC150P	AC200P	AC250P	AC350P	AP301M	AC150K	ACK15A	AW100K	AP100S	
Finishing	 SNMG 120404E-PB1 120408E-PB1 120412E-PB1	0.4	0.05-0.15	0.26-3.2	○	○	○							
		0.8	0.10-0.30	0.52-3.2	○	○	●							
		1.2	0.15-0.45	0.78-3.2	●	○	○							
	 SNMG 120404E-MB2 120408E-MB2	0.4	0.05-0.15	0.26-3.2					○					●
		0.8	0.10-0.30	0.52-3.2					○					○
Semifinishing	 SNMG 120404E-PC3 120408E-PC3 120412E-PC3	0.4	0.07-0.20	0.34-3.8	○		○							
		0.8	0.14-0.40	0.68-3.8	○		●							
		1.2	0.20-0.60	1.02-3.8	○		○							
Medium	 SNMG 120404E-PD3 120408E-PD3 120412E-PD3 190608E-PD3	0.4	0.08-0.22	0.40-4.2	○	○	○	○						
		0.8	0.15-0.44	0.80-4.2	●	○	●	●						
		1.2	0.23-0.66	1.20-4.2	○	○	○	○						
		0.8	0.15-0.44	0.80-6.3	○	○	○	○						
	 SNMG 120408E-SC3 120412E-SC3 150612E-SC3 150616E-SC3 190612E-SC3	0.8	0.15-0.44	0.80-4.2										●
		1.2	0.23-0.66	1.20-4.2										●
		1.2	0.23-0.66	1.20-5.2										○
		1.6	0.30-0.88	1.60-5.2										○
		1.2	0.23-0.66	1.20-6.3										●
	 SNMG 120404E-MC3 120408E-MC3 120412E-MC3 150612E-MC3 150616E-MC3 190612E-MC3 190616E-MC3	0.4	0.08-0.22	0.32-4.2					○					
		0.8	0.15-0.44	0.64-4.2					●					
		1.2	0.23-0.66	0.96-4.2					○					
		1.2	0.23-0.66	0.96-5.2					○					
		1.6	0.30-0.88	1.28-5.2					○					
		1.2	0.23-0.66	0.96-6.3					○					

Marked : ● Stock available ○ Non-stocked standard

Turning inserts

Negative 90° (S) Square Inserts

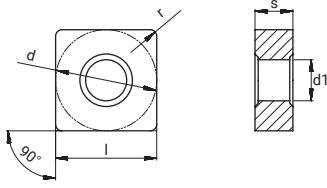

Dimensions (mm)				
Type	d	l	s	d1
SN_0903_	9.52	9.52	3.18	3.81
SN_1204_	12.7	12.7	4.76	5.16
SN_1506_	15.87	15.87	6.35	6.35
SN_1906_	19.05	19.05	6.35	7.94

Inserts	Type	r (mm)	Recommended parameters		Grades								
			f (mm/rev)	ap (mm)	AC150P	AC200P	AC250P	AC350P	AP301M	AC150K	ACK15A	AW100K	APT100S
Medium	SNMG 120404E-PC4	0.4	0.08-0.22	0.40-4.2	○	○	○			○	○		
	120408E-PC4	0.8	0.15-0.44	0.80-4.2	●	○	●			○	●		
	120412E-PC4	1.2	0.23-0.66	1.20-4.2	●	○	●			○	●		
Roughing	SNMG 120408E-MC4	0.8	0.20-0.60	1.20-6.4					○				●
	120412E-MC4	1.2	0.30-0.90	1.80-6.4					○				○
	150612E-MC4	1.2	0.30-0.90	1.80-7.9					○				○
	150616E-MC4	1.6	0.40-1.20	2.40-7.9					○				○
	190612E-MC4	1.2	0.30-0.90	1.80-9.5					○				○
	190616E-MC4	1.6	0.40-1.20	2.40-9.5					○				○
	SNMG 090304E-KC4	0.4	0.09-0.24	0.48-3.8						○	○		
	090308E-KC4	0.8	0.18-0.48	0.96-3.8						○	○		
	120404E-KC4	0.4	0.09-0.24	0.48-5.1						○	●		
	120408E-KC4	0.8	0.18-0.48	0.96-5.1						●	●		
	120412E-KC4	1.2	0.26-0.72	1.44-5.1						●	●		
	150608E-KC4	0.8	0.18-0.48	0.96-6.4						○	○		
	150612E-KC4	1.2	0.26-0.72	1.44-6.4						○	●		
	150616E-KC4	1.6	0.35-0.96	1.92-6.4						○	○		
	190608E-KC4	0.8	0.18-0.48	0.96-7.6						○	○		
	190612E-KC4	1.2	0.26-0.72	1.44-7.6						○	●		
	190616E-KC4	1.6	0.35-0.96	1.92-7.6						○	●		
	190624E-KC4	2.4	0.53-1.44	2.88-7.6						○	○		
	SNMG 150608E-PD5	0.8	0.20-0.60	1.20-7.9	○	○	○	○					
	150612E-PD5	1.2	0.30-0.90	1.80-7.9	○	○	●	○					
150616E-PD5	1.6	0.40-1.20	2.40-7.9	○	○	○	○						
190612E-PD5	1.2	0.30-0.90	1.80-9.5	●	○	●	○						
190616E-PD5	1.6	0.40-1.20	2.40-9.5	○	○	●	○						

Marked : ● Stock available ○ Non-stocked standard

Negative 90° (S) Square Inserts

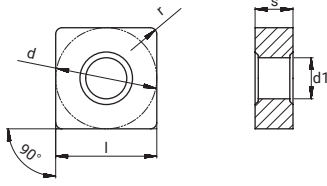

Dimensions (mm)				
Type	d	l	s	d1
SN_1204_	12.7	12.7	4.76	5.16
SN_1506_	15.87	15.88	6.35	6.35
SN_1906_	19.05	19.05	6.35	7.94
SN_2507_	25.4	25.4	7.94	9.12
SN_2509_	25.4	25.4	9.52	9.12
SN_3109_	31.75	31.75	9.52	9.45

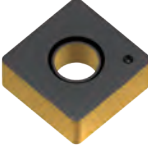
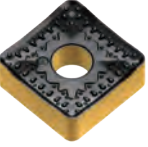
Inserts	Type	r (mm)	Recommended parameters		Grades								
			f (mm/rev)	ap (mm)	AC150P	AC200P	AC250P	AC350P	AP301M	AC150K	ACK15A	AW100K	APT100S
	SNMA 120408E-KD5	0.8	0.20-0.60	1.20-6.4						○	○		
	120412E-KD5	1.2	0.30-0.90	1.80-6.4						●	●		
	120416E-KD5	1.6	0.40-1.20	2.40-6.4						●	○		
	150612E-KD5	1.2	0.30-0.90	1.80-7.9						○	●		
	150616E-KD5	1.6	0.40-1.20	2.40-7.9						○	○		
	190612E-KD5	1.2	0.30-0.90	1.80-9.5						○	●		
190616E-KD5	1.6	0.40-1.20	2.40-9.5						●	●			
	SNMM 120408E-PD8	0.8	0.16-0.32	1.44-5.1	○		○	○					
	120412E-PD8	1.2	0.24-0.48	2.16-5.1	○		○	○					
	150612E-PD8	1.2	0.24-0.48	2.16-6.4	○		○	○					
	150616E-PD8	1.6	0.32-0.64	2.88-6.4	○		○	○					
	190612E-PD8	1.2	0.24-0.48	2.16-7.6	○		○	○					
	190616E-PD8	1.6	0.32-0.64	2.88-7.6	○		○	●					
	190624E-PD8	2.4	0.48-0.96	4.32-7.6	○		○	○					
	250724E-PD8	2.4	0.48-0.96	4.32-10.2	○		○	○					
	250924E-PD8	2.4	0.48-0.96	4.32-10.2	○		○	○					
	SNMM 190612S-PC9	1.2	0.26-0.60	2.40-9.5	●	○	○	○					
	190616S-PC9	1.6	0.35-0.80	3.20-9.5	○	○	○	○					
	190624S-PC9	2.4	0.53-1.20	4.80-9.5	○	○	○	○					
	250724S-PC9	2.4	0.53-1.20	4.80-12.7	○	○	○	○					
	250924S-PC9	2.4	0.53-1.20	4.80-12.7	●	○	●	○					
	SNMH 310924S-PC9	2.4	0.53-1.20	4.80-15.9			○	●					
	SNMM 190612S-PD9	1.2	0.30-0.72	2.64-11.4	○	○	○	○					
	190616S-PD9	1.6	0.40-0.96	3.52-11.4	○	○	○	○					
	190624S-PD9	2.4	0.60-1.44	5.28-11.4	○	○	●	○					
250724S-PD9	2.4	0.60-1.44	5.28-15.2	○	○	○	○						
250924S-PD9	2.4	0.60-1.44	5.28-15.2	●	○	●	●						
SNMX 310924S-PD9	2.4	0.60-1.44	5.28-19.1			○	●						





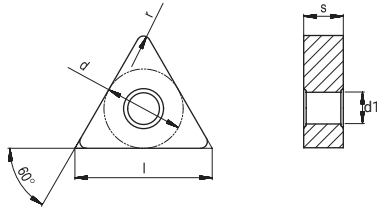

Marked : ● Stock available ○ Non-stocked standard

Turning inserts

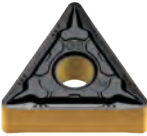
Negative 60° (T) Triangle Inserts

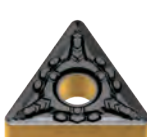

Dimensions (mm)				
Type	d	l	s	d1
TN_1604_	9.52	16.5	4.76	3.81



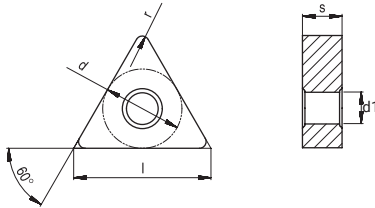

Inserts Right-hand shown where it's applicable	Type	r (mm)	Recommended parameters		Grades												
			f (mm/rev)	ap (mm)	AC150P	AC200P	AC250P	AC350P	AP301M	AC150K	ACK15A	AW100K	AP100S				
Finishing	 TNMG 160404E-PB1 160408E-PB1 160412E-PB1	0.4	0.05-0.15	0.26-3.1	●	○	●										
		0.8	0.10-0.30	0.52-3.1	●	●	●										
		1.2	0.15-0.45	0.78-3.1	●	○	○										
	 TNMG 160404E-MB2 160408E-MB2	0.4	0.05-0.15	0.26-3.1					●							●	
		0.8	0.10-0.30	0.52-3.1					○							●	
	Semifinishing	 TNMG 160404E-PB3 160408E-PB3 160412E-PB3	0.4	0.06-0.18	0.30-3.3	●	○	●									
0.8			0.12-0.36	0.60-3.3	●	●	●										
1.2			0.18-0.54	0.90-3.3	●	○	●										
 TNMG 160404E-PC3 160408E-PC3 160412E-PC3		0.4	0.07-0.20	0.34-3.7	●	○	●										
		0.8	0.14-0.40	0.68-3.7	●	○	●										
		1.2	0.20-0.60	1.02-3.7	○	○	○										
Medium	 TNMG 160404E-PD3 160408E-PD3 160412E-PD3	0.4	0.08-0.22	0.40-4.1	●	○	●	○									
		0.8	0.15-0.44	0.80-4.1	●	●	●	○									
		1.2	0.23-0.66	1.20-4.1	●	●	●	○									
	 TNMG 160404R-PL5 160408R-PL5 160404L-PL5 160408L-PL5	0.4	0.08-0.22	0.40-4.1	●	○	●										
		0.8	0.15-0.44	0.80-4.1	●	○	●										
		0.4	0.08-0.22	0.40-4.1	●	○	●										
		0.8	0.15-0.44	0.80-4.1	●	○	●										
	 TNMG 160404E-SC3 160408E-SC3 160412E-SC3	0.4	0.08-0.22	0.40-4.1												●	
		0.8	0.15-0.44	0.80-4.1												●	
		1.2	0.23-0.66	1.20-4.1												○	

Marked : ● Stock available ○ Non-stocked standard

Negative 60° (T) Triangle Inserts



Dimensions (mm)				
Type	d	l	s	d1
TN_1103_	6.35	11.0	3.18	2.26
TN_1604_	9.52	16.5	4.76	3.81
TN_2204_	12.7	22.0	4.76	5.16

Inserts	Type	r (mm)	Recommended parameters		Grades										
			f (mm/rev)	ap (mm)	AC150P	AC200P	AC250P	AC350P	AP301M	AC150K	ACK15A	AW100K	AP100S		
Medium		TNMG 160404E-MC3	0.4	0.08-0.22	0.32-4.1					●					○
		160408E-MC3	0.8	0.15-0.44	0.64-4.1					●					○
		160412E-MC3	1.2	0.23-0.66	0.96-4.1					●					○
		220408E-MC3	0.8	0.15-0.44	0.64-4.9					●					●
		220412E-MC3	1.2	0.23-0.66	0.96-4.9					○					○
		TNMG 160404E-PC4	0.4	0.08-0.22	0.40-4.1	●	○	○			○	○			
		160408E-PC4	0.8	0.15-0.44	0.80-4.1	●	○	●			●	●			
		160412E-PC4	1.2	0.23-0.66	1.20-4.1	○	○	○			●	○			
220412E-PC4		1.2	0.23-0.66	1.20-4.9	○	○	○			○	○				
Roughing		TNMG 160408E-MC4	0.8	0.20-0.60	1.20-5.8					●				●	
		160412E-MC4	1.2	0.30-0.90	1.80-5.8					○				○	
		220408E-MC4	0.8	0.20-0.60	1.20-6.6					○				○	
		220412E-MC4	1.2	0.30-0.90	1.80-6.6					○				○	
		TNMG 110304E-KC4	0.4	0.09-0.24	0.48-3.3						○	○			
		160404E-KC4	0.4	0.09-0.24	0.48-4.9						○	●			
		160408E-KC4	0.8	0.18-0.48	0.96-4.9						●	●			
		160412E-KC4	1.2	0.26-0.72	1.44-4.9						○	○			
		160416E-KC4	1.6	0.35-0.96	1.92-4.9						○	○			
		220412E-KC4	1.2	0.26-0.72	1.44-6.0						○	●			
		220416E-KC4	1.6	0.35-0.96	1.92-6.0						○	○			

Marked : ● Stock available ○ Non-stocked standard

Turning inserts

Negative 60° (T) Triangle Inserts

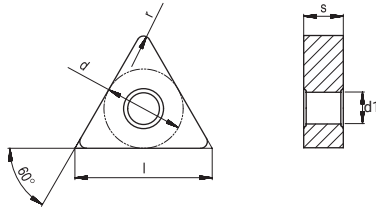

Dimensions (mm)				
Type	d	l	s	d1
TN_1604_	9.52	16.5	4.76	3.81
TN_2204_	12.7	22.0	4.76	5.16







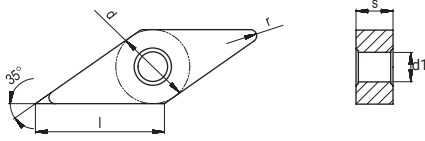

Inserts Right-hand shown where it's applicable	Type	r (mm)	Recommended parameters		Grades											
			f (mm/rev)	ap (mm)	AC150P	AC200P	AC250P	AC350P	AP301M	AC150K	ACK15A	AW100K	AP100S			
Roughing		TNMG 160408E-PD5	0.8	0.20-0.60	1.20-5.8	○	○	○	●							
		160412E-PD5	1.2	0.30-0.90	1.80-5.8	○	○	○	●							
		220408E-PD5	0.8	0.20-0.60	1.20-7.7	○	○	●	○							
		220412E-PD5	1.2	0.30-0.90	1.80-7.7	○	○	○	○							
		220416E-PD5	1.6	0.40-1.20	2.40-7.7	○	○	○	○							
		TNMA 160404E-KD5	0.4	0.10-0.30	0.60-5.8						●	○				
		160408E-KD5	0.8	0.20-0.60	1.20-5.8						●	●				
		160412E-KD5	1.2	0.30-0.90	1.80-5.8						●	●				
		160416E-KD5	1.6	0.40-1.20	2.40-5.8						○	○				
		220408E-KD5	0.8	0.20-0.60	1.20-7.7						○	○				
220412E-KD5		1.2	0.30-0.90	1.80-7.7						○	○					
Heavy roughing		TNMM 160408E-PD8	0.8	0.16-0.32	1.44-4.9	○		○	○							
		160412E-PD8	1.2	0.24-0.48	2.16-4.9	○		○	○							
		220408E-PD8	0.8	0.16-0.32	1.44-6.0	○		○	○							
		220412E-PD8	1.2	0.24-0.48	2.16-6.0	○		○	○							
		220416E-PD8	1.6	0.32-0.64	2.88-6.0	○		○	○							
Finishing		TNGG 160402FR-F	0.2	0.08-0.20	0.5-2.3					●						
		160402FL-F	0.2	0.08-0.20	0.5-2.3					●						
		160404FR-F	0.4	0.08-0.20	0.5-2.3					●						
		160404FL-F	0.4	0.08-0.20	0.5-2.3					●						
Semifinishing-roughing		TNGG 160404R-H	0.4	0.22-0.38	1.2-3.8					●						
		160404L-H	0.4	0.22-0.38	1.2-3.8					●						
		160408R-H	0.8	0.22-0.38	1.2-3.8					●						
		160408L-H	0.8	0.22-0.38	1.2-3.8					●						

Marked : ● Stock available ○ Non-stocked standard

Negative 35° (V) Rhombic Inserts



Dimensions (mm)				
Type	d	l	s	d1
VN_1604_	9.52	16.5	4.76	3.81

Inserts	Type	r (mm)	Recommended parameters		Grades												
			f (mm/rev)	ap (mm)	AC150P	AC200P	AC250P	AC350P	AP301M	AC150K	ACK15A	AW100K	APT100S				
Finishing	 VNMG 160404E-PB1 160408E-PB1	0.4	0.05-0.15	0.26-2.1	●	○	●										
		0.8	0.10-0.30	0.52-2.1	●	●	●										
	 VNMG 160404E-MB2 160408E-MB2	0.4	0.05-0.15	0.26-2.1						●							●
		0.8	0.10-0.30	0.52-2.1						●							●
Semifinishing	 VNMG 160404E-PB3 160408E-PB3 160412E-PB3	0.4	0.06-0.18	0.30-3.1	●	○	●										
		0.8	0.12-0.36	0.60-3.1	●	●	●										
		1.2	0.18-0.54	0.90-3.1	●	○	●										
	 VNMG 160404E-PC3 160408E-PC3 160412E-PC3	0.4	0.07-0.20	0.34-3.3	●	○	●										
		0.8	0.14-0.40	0.68-3.3	○	○	●										
		1.2	0.20-0.60	1.02-3.3	○	○	○										
Medium	 VNMG 160404E-PD3 160408E-PD3 160412E-PD3	0.4	0.08-0.22	0.40-3.3	●	○	●	○									
		0.8	0.15-0.44	0.80-3.3	●	●	●	○									
		1.2	0.23-0.66	1.20-3.3	●	○	●	○									
	 VNMG 160404E-SC3 160408E-SC3 160412E-SC3	0.4	0.08-0.22	0.40-3.3													●
		0.8	0.15-0.44	0.80-3.3													●
		1.2	0.23-0.66	1.20-3.3													●
	 VNMG 160404E-MC3 160408E-MC3	0.4	0.08-0.22	0.32-3.3						●							
		0.8	0.15-0.44	0.64-3.3						●							
	 VNMG 160404E-PC4 160408E-PC4 160412E-PC4	0.4	0.08-0.22	0.40-3.3	○		●				○	●					
		0.8	0.15-0.44	0.80-3.3	●		○				●	●					
		1.2	0.23-0.66	1.20-3.3	○		○				●	○					
Roughing	 VNMG 160404E-KC4 160408E-KC4 160412E-KC4	0.4	0.09-0.24	0.48-3.3						○	●						
		0.8	0.18-0.48	0.96-3.3						●	●						
		1.2	0.26-0.72	1.44-3.3						○	○						

Marked : ● Stock available ○ Non-stocked standard

Turning inserts

Negative 80° (W) Trigon Inserts

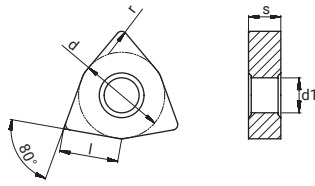

Dimensions (mm)				
Type	d	l	s	d1
WN_0604_	9.52	6.52	4.76	3.81
WN_0804_	12.7	8.7	4.76	5.16

Inserts	Type	r (mm)	Recommended parameters		Grades											
			f (mm/rev)	ap (mm)	AC150P	AC200P	AC250P	AC350P	AP301M	AC150K	ACK15A	AW100K	AP100S			
Finishing		WNMG 080404E-PB1	0.4	0.05-0.15	0.26-2.2	●	○	●								
		080408E-PB1	0.8	0.10-0.30	0.52-2.2	●	○	●								
		080412E-PB1	1.2	0.15-0.45	0.78-2.2	○	○	○								
		WNMG 080404E-MB2	0.4	0.05-0.15	0.26-2.2					●						●
		080408E-MB2	0.8	0.10-0.30	0.52-2.2					●						●
	Semifinishing		WNMG 080404E-PB3	0.4	0.06-0.18	0.30-2.3	●	○	●							
080408E-PB3			0.8	0.12-0.36	0.60-2.3	●	○	●								
080412E-PB3			1.2	0.18-0.54	0.90-2.3	●	○	●								
		WNMG 080404E-PC3	0.4	0.07-0.20	0.34-2.6	●	○	●								
		080408E-PC3	0.8	0.14-0.40	0.68-2.6	●	○	●								
		080412E-PC3	1.2	0.20-0.60	1.02-2.6	●	○	●								
Medium		WNMG 060408E-PD3	0.8	0.15-0.44	0.80-2.1	●	○	●	○							
		080404E-PD3	0.4	0.08-0.22	0.40-2.9	●	○	●	○							
		080408E-PD3	0.8	0.15-0.44	0.80-2.9	●	●	●	●							
		080412E-PD3	1.2	0.23-0.66	1.20-2.9	●	●	●	●							
		WNMG 080404E-SC3	0.4	0.08-0.22	0.40-2.9											●
		080408E-SC3	0.8	0.15-0.44	0.80-2.9					○						●
		080412E-SC3	1.2	0.23-0.66	1.20-2.9											●
		WNMG 060408E-MC3	0.8	0.15-0.44	0.64-2.1					●						○
		060412E-MC3	1.2	0.23-0.66	0.96-2.1					●						○
		080404E-MC3	0.4	0.08-0.22	0.32-2.9					●						○
		080408E-MC3	0.8	0.15-0.44	0.64-2.9					●						●
		080412E-MC3	1.2	0.23-0.66	0.96-2.9					○						○

Marked : ● Stock available ○ Non-stocked standard

Negative 80° (W) Trigon Inserts

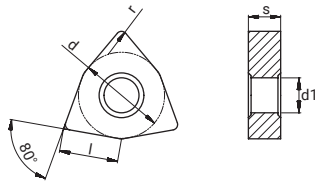

Dimensions (mm)				
Type	d	l	s	d1
WN_0604_	9.52	6.52	4.76	3.81
WN_0804_	12.7	8.7	4.76	5.16

Inserts	Type	r (mm)	Recommended parameters		Grades								
			f (mm/rev)	ap (mm)	AC150P	AC200P	AC250P	AC350P	AP301M	AC150K	ACK15A	AW100K	AP100S
Medium	WNMG 080404E-PC4	0.4	0.08-0.22	0.40-2.9	○		●			●	●		
	080408E-PC4	0.8	0.15-0.44	0.80-2.9	●		●			●	●		
	080412E-PC4	1.2	0.23-0.66	1.20-2.9	●		●			●	●		
Roughing	WNMG 060408E-MC4	0.8	0.20-0.60	1.20-3.3					○				○
	060412E-MC4	1.2	0.30-0.90	1.80-3.3					○				○
	080408E-MC4	0.8	0.20-0.60	1.20-4.3					○				●
	080412E-MC4	1.2	0.30-0.90	1.80-4.3					○				●
	WNMG 060404E-KC4	0.4	0.09-0.24	0.48-2.6						○	●		
	060408E-KC4	0.8	0.18-0.48	0.96-2.6						○	●		
	080404E-KC4	0.4	0.09-0.24	0.48-3.5						○	●		
	080408E-KC4	0.8	0.18-0.48	0.96-3.5						●	●		
	080412E-KC4	1.2	0.26-0.72	1.44-3.5						●	●		
	080416E-KC4	1.2	0.35-0.96	1.92-3.5						○	○		
	WNMG 080408E-PD5	0.8	0.20-0.60	1.20-4.3	○	●	●	●					
	080412E-PD5	1.2	0.30-0.90	1.80-4.3	○	○	●	●					
	WNMA 080404E-KD5	0.4	0.10-0.30	0.60-4.3						○	○		
	080408E-KD5	0.8	0.20-0.60	1.20-4.3						○	●		
	080412E-KD5	1.2	0.30-0.90	1.80-4.3						●	●		
	080416E-KD5	1.6	0.40-1.20	2.40-4.3						○	●		

Marked : ● Stock available ○ Non-stocked standard



P72

Turning inserts

Negative 90° (L) Rectangle Inserts

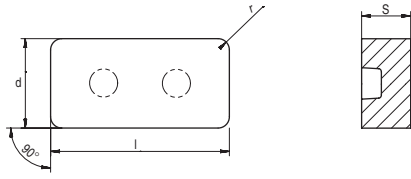

Dimensions (mm)			
Type	l	d	s
LN_5014_	50.8	25.4	14.2

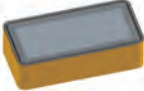
Inserts	Type	r (mm)	Recommended parameters		Grades															
			f (mm/rev)	ap (mm)	AC150P	AC200P	AC250P	AC350P	AP301M	AC150K	ACK15A	AW100K	AP100S							
Heavy roughing 	LNMX 501432S-HE	3.2	0.70-1.6	6.0-40.0			○	●												

Marked : ● Stock available ○ Non-stocked standard

Positive 80° (C) Rhombic Inserts

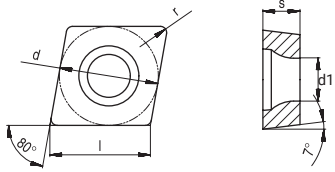

Dimensions (mm)				
Type	d	l	s	d1
CC_0602_	6.35	6.45	2.38	2.8
CC_09T3_	9.52	9.67	3.97	4.4
CC_1204_	12.7	12.9	4.76	5.5

Inserts	Type	r (mm)	Recommended parameters		Grades									
			f (mm/rev)	ap (mm)	AC150P	AC200P	AC250P	AC350P	AP301M	AC150K	ACK15A	AW100K	APT100S	
Finishing		CCGT 060201E-UF	0.1	0.02-0.15	0.10-1.4					○				○
		060202E-UF	0.2	0.02-0.15	0.10-1.4					●				●
		060204E-UF	0.4	0.03-0.20	0.10-1.4					●				●
		09T301E-UF	0.1	0.02-0.15	0.10-2.4					●				●
		09T302E-UF	0.2	0.02-0.15	0.10-2.4					●				●
		09T304E-UF	0.4	0.03-0.20	0.10-2.4					○				○
	09T308E-UF	0.8	0.03-0.25	0.10-2.4					●				○	
		CCGT 060201F-UF	0.1	0.02-0.15	0.10-1.4					●				
		060202F-UF	0.2	0.02-0.15	0.10-1.4					●				
		060204F-UF	0.4	0.03-0.20	0.10-1.4					●				
		09T301F-UF	0.1	0.02-0.15	0.10-2.4					●				
		09T302F-UF	0.2	0.02-0.15	0.10-2.4					●				
09T304F-UF		0.4	0.03-0.20	0.10-2.4					●					
Semifinishing		CCGT 060204F-NC2	0.4	0.05-0.20	0.32-2.9								●	
		09T302F-NC2	0.2	0.02-0.10	0.16-4.4								○	
		09T304F-NC2	0.4	0.05-0.20	0.32-4.4								●	
		09T308F-NC2	0.8	0.10-0.40	0.64-4.4								●	
		120404F-NC2	0.4	0.05-0.20	0.32-5.8								●	
		120408F-NC2	0.8	0.10-0.40	0.64-5.8								○	
Finishing		CCMT 060202E-PB1	0.2	0.02-0.07	0.15-1.6	○	○	○		●				
		060204E-PB1	0.4	0.04-0.14	0.30-1.6	●	○	●		●				
		060208E-PB1	0.8	0.09-0.28	0.60-1.6	○	○	○		●				
		09T302E-PB1	0.2	0.02-0.07	0.15-2.4	○	○	○		●				
		09T304E-PB1	0.4	0.04-0.14	0.30-2.4	●	○	●		●				○
		09T308E-PB1	0.8	0.09-0.28	0.60-2.4	●	●	●		●				
Semifinishing		CCMT 060204E-PC2	0.4	0.05-0.16	0.35-1.9	●	○	●		●				●
		060208E-PC2	0.8	0.10-0.32	0.70-1.9	●	○	●		●				●
		09T304E-PC2	0.4	0.05-0.16	0.35-2.9	●	●	●		●				●
		09T308E-PC2	0.8	0.10-0.32	0.70-2.9	●	●	●		●				●
		09T312E-PC2	1.2	0.16-0.48	1.05-2.9	○	○	○		●				○
		120404E-PC2	0.4	0.05-0.16	0.35-3.9	●	○	●		●				●
		120408E-PC2	0.8	0.10-0.32	0.70-3.9	●	○	●		●				●
		120412E-PC2	1.2	0.16-0.48	1.05-3.9	○	○	○		○				○



Marked : ● Stock available ○ Non-stocked standard

Turning inserts

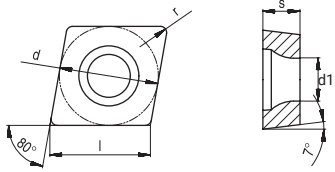
Positive 80° (C) Rhombic Inserts

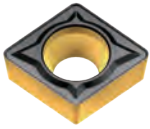
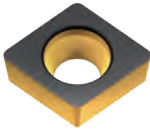

Dimensions (mm)				
Type	d	l	s	d1
CC_0301_	3.5	3.55	1.4	2.0
CC_0401_	4.3	4.37	1.8	2.3
CC_0602_	6.35	6.45	2.38	2.8
CC_09T3_	9.52	9.67	3.97	4.4
CC_1204_	12.7	12.9	4.76	5.5



Inserts Left-hand shown where it's applicable	Type	r (mm)	Recommended parameters		Grades									
			f (mm/rev)	ap (mm)	AC150P	AC200P	AC250P	AC350P	AP301M	AC150K	ACK15A	AW100K	APT100S	
Semifinishing 	CCMT 060204E-KC2	0.4	0.06-0.18	0.40-2.1	○	○	●	○	●	○	●			●
	060208E-KC2	0.8	0.12-0.36	0.80-2.1	○	○	○	○	○	○	●			
	09T304E-KC2	0.4	0.06-0.18	0.40-3.2	●	○	●	○	●	●	●			
	09T308E-KC2	0.8	0.12-0.36	0.80-3.2	●	●	●	○	●	●	●			
	120404E-KC2	0.4	0.06-0.18	0.40-4.3	○	○	○	○	○	○	●			
	120408E-KC2	0.8	0.12-0.36	0.80-4.3	●	○	●	●	●	●	●			
	120412E-KC2	1.2	0.18-0.54	1.20-4.3	○	○	●	○	○	○	●			
Roughing 	CCMW 060204E-KD5	0.4	0.10-0.22	0.40-3.2						○	○			
	09T304E-KD5	0.4	0.10-0.22	0.40-4.8						○	○			
	09T308E-KD5	0.8	0.20-0.44	0.80-4.8						○	●			
	120404E-KD5	0.4	0.10-0.22	0.40-6.4						○	○			
	120408E-KD5	0.8	0.20-0.44	0.80-6.4						○	●			
	120412E-KD5	1.2	0.30-0.66	1.20-6.4						○	○			
Finishing 	CCET 0301003FR-F	<0.03	0.01-0.05	0.1-0.3					○					
	0301003FL-F	<0.03	0.01-0.05	0.1-0.3					○					
	030101FR-F	<0.1	0.01-0.05	0.1-0.3					○					
	030101FL-F	<0.1	0.01-0.05	0.1-0.3					○					
	030102FR-F	<0.2	0.01-0.05	0.1-0.3					○					
	030102FL-F	<0.2	0.01-0.05	0.1-0.3					○					
	030104FR-F	<0.4	0.01-0.05	0.1-0.3					○					
	030104FL-F	<0.4	0.01-0.05	0.1-0.3					○					
	CCET 0401003FR-F	<0.03	0.01-0.06	0.1-0.4					○					
	0401003FL-F	<0.03	0.01-0.06	0.1-0.4					○					
	040101FR-F	<0.1	0.01-0.06	0.1-0.4					○					
	040101FL-F	<0.1	0.01-0.06	0.1-0.4					○					
	040102FR-F	<0.2	0.01-0.06	0.1-0.4					○					
	040102FL-F	<0.2	0.01-0.06	0.1-0.4					○					
	040104FR-F	<0.4	0.01-0.06	0.1-0.4					○					
040104FL-F	<0.4	0.01-0.06	0.1-0.4					○						

Marked : ● Stock available ○ Non-stocked standard

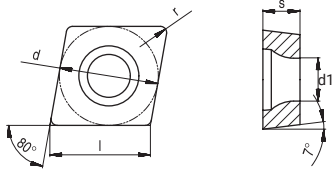
Positive 80° (C) Rhombic Inserts



Dimensions (mm)				
Type	d	l	s	d1
CC_0602_	6.35	6.45	2.38	2.8
CC_09T3_	9.52	9.67	3.97	4.4

Inserts Left-hand shown where it's applicable	Type	r (mm)	Recommended parameters		Grades											
			f (mm/rev)	ap (mm)	AC150P	AC200P	AC250P	AC350P	AP301M	AC150K	ACK15A	AW100K	AP100S			
Low feed		CCET 0602003FR-M	<0.03	0.02-0.10	0.5-2.5					○						
		0602003FL-M	<0.03	0.02-0.10	0.5-2.5					○						
		060201FR-M	<0.1	0.02-0.10	0.5-2.5					○						
		060201FL-M	<0.1	0.02-0.10	0.5-2.5					○						
		060202FR-M	<0.2	0.02-0.10	0.5-2.5					○						
		060202FL-M	<0.2	0.02-0.10	0.5-2.5					○						
		060204FR-M	<0.4	0.01-0.10	0.5-2.5					○						
		060204FL-M	<0.4	0.01-0.10	0.5-2.5					○						
			CCET 09T3003FR-M	<0.03	0.02-0.10	0.5-4.0					●					
		09T3003FL-M	<0.03	0.02-0.10	0.5-4.0					●						
		09T301FR-M	<0.1	0.02-0.10	0.5-4.0					●						
		09T301FL-M	<0.1	0.02-0.10	0.5-4.0					●						
		09T302FR-M	<0.2	0.02-0.10	0.5-4.0					●						
		09T302FL-M	<0.2	0.02-0.10	0.5-4.0					●						
	09T304FR-M	<0.4	0.02-0.10	0.5-4.0					●							
	09T304FL-M	<0.4	0.02-0.10	0.5-4.0					●							

Marked : ● Stock available ○ Non-stocked standard

Turning inserts

Positive 55° (D) Rhombic Inserts

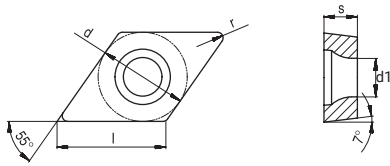

Dimensions (mm)				
Type	d	l	s	d1
DC_0702_	6.35	7.75	2.38	2.8
DC_11T3_	9.52	11.62	3.97	4.4

Inserts	Type	r (mm)	Recommended parameters		Grades										
			f (mm/rev)	ap (mm)	AC150P	AC200P	AC250P	AC350P	AP301M	AC150K	ACK15A	AW100K	AP100S		
Finishing		DCGT 070201E-UF	0.1	0.02-0.15	0.10-1.4					●					○
		070202E-UF	0.2	0.02-0.15	0.10-1.4					●					○
		070204E-UF	0.4	0.03-0.20	0.10-1.4					●					○
		11T301E-UF	0.1	0.02-0.15	0.10-2.4					●					●
		11T302E-UF	0.2	0.02-0.15	0.10-2.4					●					●
		11T304E-UF	0.4	0.03-0.20	0.10-2.4					●					●
		DCGT 070201F-UF	0.1	0.02-0.15	0.10-1.4					●					
		070202F-UF	0.2	0.02-0.15	0.10-1.4					●					
		070204F-UF	0.4	0.03-0.20	0.10-1.4					●					
		11T301F-UF	0.1	0.02-0.15	0.10-2.4					●					
		11T302F-UF	0.2	0.02-0.15	0.10-2.4					●					
		11T304F-UF	0.4	0.03-0.20	0.10-2.4					●					
Semifinishing		DCGT 070202F-NC2	0.2	0.02-0.10	0.16-3.5									○	
		070204F-NC2	0.4	0.05-0.20	0.32-3.5									○	
		11T302F-NC2	0.2	0.02-0.10	0.16-5.2								●		
		11T304F-NC2	0.4	0.05-0.20	0.32-5.2								●		
		11T308F-NC2	0.8	0.10-0.40	0.64-5.2								○		
Finishing		DCMT 070202E-PB1	0.2	0.02-0.07	0.15-1.5	○	○	○		○					
		070204E-PB1	0.4	0.04-0.14	0.30-1.5	●	○	●		●					
		11T302E-PB1	0.2	0.02-0.07	0.15-2.3	●	○	●		●					
		11T304E-PB1	0.4	0.04-0.14	0.30-2.3	●	○	●		●					
		11T308E-PB1	0.8	0.09-0.28	0.60-2.3	●	○	●		○					
Semifinishing		DCMT 070204E-PC2	0.4	0.05-0.16	0.35-2.1	○	○	●		●				●	
		070208E-PC2	0.8	0.10-0.32	0.70-2.1	●	○	●		●				○	
		11T304E-PC2	0.4	0.05-0.16	0.35-3.1	●	○	●		●				●	
		11T308E-PC2	0.8	0.10-0.32	0.70-3.1	●	●	●		●				●	
		11T312E-PC2	1.2	0.16-0.48	1.05-3.1	○	○	○		○				●	

Marked : ● Stock available ○ Non-stocked standard

Positive 55° (D) Rhombic Inserts

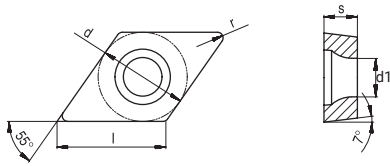

Dimensions (mm)				
Type	d	l	s	d1
DC_0702_	6.35	7.75	2.38	2.8
DC_11T3_	9.52	11.62	3.97	4.4

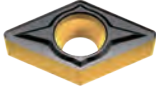
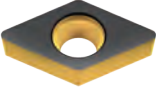
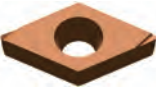
Inserts Left-hand shown where it's applicable	Type	r (mm)	Recommended parameters		Grades												
			f (mm/rev)	ap (mm)	AC150P	AC200P	AC250P	AC350P	AP301M	AC150K	ACK15A	AW100K	AP100S				
Semifinishing 	DCMT 070204E-KC2	0.4	0.06-0.18	0.40-2.3	○	○	○			○	●						
	070208E-KC2	0.8	0.12-0.36	0.80-2.3	○	○	○	○		○	●						
	11T304E-KC2	0.4	0.06-0.18	0.40-3.5	●	○	●			●	●						
	11T308E-KC2	0.8	0.12-0.36	0.80-3.5	●	○	●	○		●	●						
	11T312E-KC2	1.2	0.18-0.54	1.20-3.5	○	○	○			○	○						
Roughing 	DCMW 070204E-KD5	0.4	0.06-0.18	0.40-3.9						○	○						
	070208E-KD5	0.8	0.12-0.36	0.80-3.9						○	○						
	11T304E-KD5	0.4	0.06-0.18	0.40-5.8						○	○						
	11T308E-KD5	0.8	0.12-0.36	0.80-5.8						○	○						
Finishing 	DCET 0702003FR-F	<0.03	0.02-0.18	0.1-0.4						○							
	0702003FL-F	<0.03	0.02-0.18	0.1-0.4						○							
	070201FR-F	<0.1	0.02-0.18	0.1-0.4						○							
	070201FL-F	<0.1	0.02-0.18	0.1-0.4						○							
	070202FR-F	<0.2	0.02-0.18	0.1-0.4						○							
	070202FL-F	<0.2	0.02-0.18	0.1-0.4						○							
	070204FR-F	<0.4	0.02-0.18	0.1-0.4						○							
	070204FL-F	<0.4	0.02-0.18	0.1-0.4						○							
	DCET 11T3003FR-F	<0.03	0.02-0.20	0.1-0.4						●							
	11T3003FL-F	<0.03	0.02-0.20	0.1-0.4						●							
	11T301FR-F	<0.1	0.02-0.20	0.1-0.4						●							
	11T301FL-F	<0.1	0.02-0.20	0.1-0.4						●							
	11T302FR-F	<0.2	0.02-0.20	0.1-0.4						●							
	11T302FL-F	<0.2	0.02-0.20	0.1-0.4						●							
	11T304FR-F	<0.4	0.02-0.20	0.1-0.4						●							
11T304FL-F	<0.4	0.02-0.20	0.1-0.4						●								

Marked : ● Stock available ○ Non-stocked standard

Turning inserts

Positive 55° (D) Rhombic Inserts

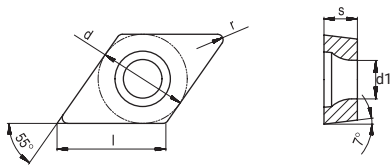

Dimensions (mm)				
Type	d	l	s	d1
DC_0702_	6.35	7.75	2.38	2.8
DC_11T3_	9.52	11.62	3.97	4.4

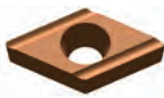
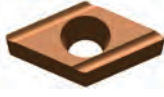
Inserts Left-hand shown where it's applicable	Type	r (mm)	Recommended parameters		Grades										
			f (mm/rev)	ap (mm)	AC150P	AC200P	AC250P	AC350P	AP301M	AC150K	ACK15A	AW100K	AP100S		
	DCET 0702003FR-M	<0.03	0.01-0.08	0.5-2.8					○						
	0702003FL-M	<0.03	0.01-0.08	0.5-2.8					○						
	070201FR-M	<0.1	0.01-0.08	0.5-2.8					○						
	070201FL-M	<0.1	0.01-0.08	0.5-2.8					○						
	070202FR-M	<0.2	0.01-0.08	0.5-2.8					○						
	070202FL-M	<0.2	0.01-0.08	0.5-2.8					○						
	070204FR-M	<0.4	0.01-0.08	0.5-2.8					○						
	070204FL-M	<0.4	0.01-0.08	0.5-2.8					○						
	DCET 11T3003FR-M	<0.03	0.01-0.10	0.5-4.0					●						
	11T3003FL-M	<0.03	0.01-0.10	0.5-4.0					●						
	11T301FR-M	<0.1	0.01-0.10	0.5-4.0					●						
	11T301FL-M	<0.1	0.01-0.10	0.5-4.0					●						
	11T302FR-M	<0.2	0.01-0.10	0.5-4.0					●						
	11T302FL-M	<0.2	0.01-0.10	0.5-4.0					●						
	11T304FR-M	<0.4	0.01-0.10	0.5-4.0					●						
	11T304FL-M	<0.4	0.01-0.10	0.5-4.0					●						

Positive 90° (S) Square Inserts

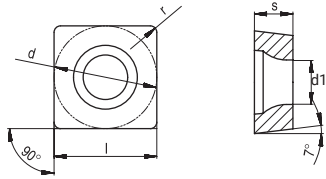

Dimensions (mm)				
Type	d	l	s	d1
SC_09T3_	9.52	9.52	3.97	4.4
SC_1204_	12.7	12.7	4.76	5.5
SC_3809_	38.1	38.1	9.52	9.8

Inserts	Type	r (mm)	Recommended parameters		Grades										
			f (mm/rev)	ap (mm)	AC150P	AC200P	AC250P	AC350P	AP301M	AC150K	ACK15A	AW100K	AP100S		
Finishing	SCMT 09T304E-PB1	0.4	0.04-0.14	0.30-2.4	●	○	○			○					
	09T308E-PB1	0.8	0.09-0.28	0.60-2.4	○	○	○		●						
	120404E-PB1	0.4	0.04-0.14	0.30-3.2	○	○	○		○						
Semifinishing	SCMT 09T304E-PC2	0.4	0.05-0.16	0.35-2.9	●	○	●		●						●
	09T308E-PC2	0.8	0.10-0.32	0.70-2.9	○	○	●		○						○
	120404E-PC2	0.4	0.05-0.16	0.35-3.8	○	○	●		●						○
	120408E-PC2	0.8	0.10-0.32	0.70-3.8	●	○	○		●						○
	120412E-PC2	1.2	0.16-0.48	1.05-3.8	○	○	○		○						○
	SCGT 09T308F-NC2	0.8	0.10-0.40	0.64-4.3										○	
	SCMT 09T304E-KC2	0.4	0.06-0.18	0.40-3.1	○	○	○	○		○	●				
	09T308E-KC2	0.8	0.12-0.36	0.80-3.1	●	○	●	○		○	●				
	120404E-KC2	0.4	0.06-0.18	0.40-4.2	○	○	○	○		○	○				
	120412E-KC2	1.2	0.18-0.54	1.20-4.2	○	○	○	○		○	●				
Roughing	SCMW 09T304E-KD5	0.4	0.10-0.22	0.40-4.8						○	○				
	09T308E-KD5	0.8	0.20-0.44	0.80-4.8						○	○				
	120404E-KD5	0.4	0.10-0.22	0.40-6.4						○	○				
	120408E-KD5	0.8	0.20-0.44	0.80-6.4						○	○				
	SCMT 380932-HT	3.2	0.70-1.40	4.0-18.0				○							

Marked : ● Stock available ○ Non-stocked standard

Turning inserts

Positive 60° (T) Triangle Inserts

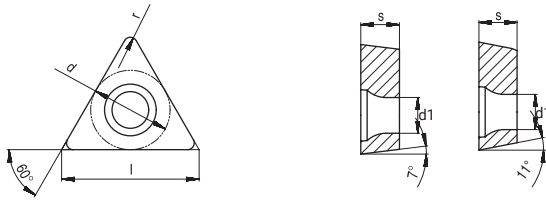

Dimensions (mm)				
Type	d	l	s	d1
TCMT_0902_	5.56	9.63	2.38	2.5
TC_1102_	6.35	11.0	2.38	2.8
TC_16T3_	9.52	16.5	3.97	4.4
TPMT_0902_	5.56	9.63	2.38	2.5
TPMT_1103_	6.35	11.0	3.18	3.4

Inserts	Type	r (mm)	Recommended parameters		Grades									
			f (mm/rev)	ap (mm)	AC150P	AC200P	AC250P	AC350P	AP301M	AC150K	ACK15A	AW100K	APT100S	
Finishing		TCGT 110201E-UF	0.1	0.02-0.15	0.10-2.4					○				○
		110202E-UF	0.2	0.02-0.15	0.20-2.4					○				○
		110204E-UF	0.4	0.03-0.20	0.20-2.4					●				○
		16T304E-UF	0.4	0.03-0.20	0.20-2.4					○				○
		TCGT 110201F-UF	0.1	0.02-0.15	0.10-2.4					●				
		110202F-UF	0.2	0.02-0.15	0.20-2.4					●				
		110204F-UF	0.4	0.03-0.20	0.20-2.4					●				
		16T304F-UF	0.4	0.03-0.20	0.20-2.4					●				
		TCMT 090204E-PB1	0.4	0.04-0.14	0.30-1.9	○	○	○		○				
		110202E-PB1	0.2	0.02-0.07	0.15-2.2	●	○	○		○				
		110204E-PB1	0.4	0.04-0.14	0.30-2.2	○	○	○		○				
		110208E-PB1	0.8	0.09-0.28	0.60-2.2	○	○	○		○				
16T304E-PB1		0.4	0.04-0.14	0.30-3.3	●	○	○		○					
16T308E-PB1		0.8	0.09-0.28	0.60-3.3	○	○	○		○					
Semifinishing		TCMT 090204E-PC2	0.4	0.05-0.16	0.35-2.6	○	○	●		●				○
		090208E-PC2	0.8	0.10-0.32	0.70-2.6	○	○	○		○				○
		110204E-PC2	0.4	0.05-0.16	0.35-3.0	○	○	●		●				●
		110208E-PC2	0.8	0.10-0.32	0.70-3.0	○	○	●		●				●
		16T304E-PC2	0.4	0.05-0.16	0.35-4.5	●	○	●		○				○
		16T308E-PC2	0.8	0.10-0.32	0.70-4.5	●	○	●		●				○
		TPMT 090204E-PC2	0.4	0.05-0.16	0.35-2.6	○	○	○		●				○
		090208E-PC2	0.8	0.10-0.32	0.70-2.6	○	○	○		●				○
		110304E-PC2	0.4	0.05-0.16	0.35-3.0	●	○	●		●				○
		110308E-PC2	0.8	0.10-0.32	0.70-3.0	○	○	○		●				○
		TCGT 110204F-NC2	0.4	0.05-0.20	0.32-4.9								○	
		16T304F-NC2	0.4	0.05-0.20	0.32-7.4								○	
16T308F-NC2		0.8	0.10-0.40	0.64-7.4								○		

Marked : ● Stock available ○ Non-stocked standard

Positive 60° (T) Triangle Inserts

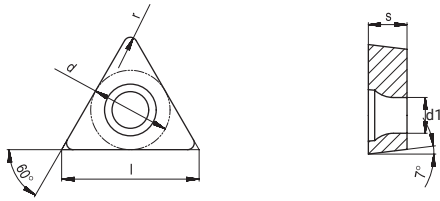

Dimensions (mm)				
Type	d	l	s	d1
TC_0902_	5.56	9.63	2.38	2.5
TC_1102_	6.35	11.0	2.38	2.8
TC_16T3_	9.52	16.5	3.97	4.4

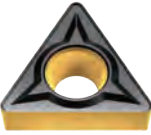
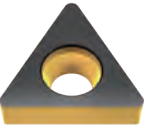
Inserts	Type	r (mm)	Recommended parameters		Grades								
			f (mm/rev)	ap (mm)	AC150P	AC200P	AC250P	AC350P	AP301M	AC150K	ACK15A	AW100K	AP100S
Semifinishing 	TCMT 090204E-KC2	0.4	0.06-0.18	0.40-2.9	○	○	○			○	●		
	090208E-KC2	0.8	0.12-0.36	0.80-2.9	○	○	○			○	●		
	110204E-KC2	0.4	0.06-0.18	0.40-3.3	○	○	●			○	●		
	110208E-KC2	0.8	0.12-0.36	0.80-3.3	○	○	○			○	●		
	16T304E-KC2	0.4	0.06-0.18	0.40-4.9	○	○	●			○	●		
	16T308E-KC2	0.8	0.12-0.36	0.80-4.9	○	○	○			●	●		
	16T312E-KC2	1.2	0.18-0.54	1.20-4.9	○	○	○			○	●		
Roughing 	TCMW 110204E-KD5	0.4	0.06-0.18	0.40-5.5						○	○		
	110208E-KD5	0.8	0.12-0.36	0.80-5.5						○	○		
	16T304E-KD5	0.4	0.06-0.18	0.40-8.2						○	○		
	16T308E-KD5	0.8	0.12-0.36	0.80-8.2						○	○		

Marked : ● Stock available ○ Non-stocked standard

Turning inserts

Positive 60° (T) Triangle Inserts

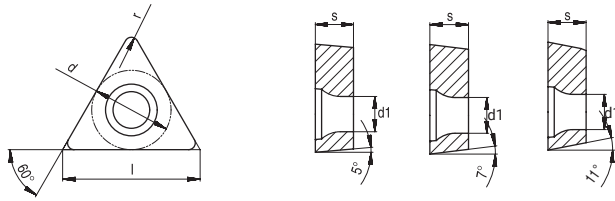

Dimensions (mm)				
Type	d	l	s	d1
TBET_0601_	3.97	6.88	1.59	2.3
TPEH_0802_	4.76	8.24	2.38	2.3
TCET_0802_	4.76	8.24	2.38	2.3
TPEH_0902_	5.56	9.63	2.38	3.0
TPEH_1103_	6.35	11.0	3.18	3.3
TCET_1103_	6.35	11.0	3.18	3.3

Inserts Left-hand shown where it's applicable	Type	r (mm)	Recommended parameters		Grades									
			f (mm/rev)	ap (mm)	AC150P	AC200P	AC250P	AC350P	AP301M	AC150K	ACK15A	AW100K	APT100S	
Finishing		TBET 0601003FR-F	<0.03	0.03-0.08	0.1-0.5					○				
		0601003FL-F	<0.03	0.03-0.08	0.1-0.5					○				
		060101FR-F	<0.1	0.03-0.08	0.1-0.5					○				
		060101FL-F	<0.1	0.03-0.08	0.1-0.5					○				
		060102FR-F	<0.2	0.03-0.08	0.1-0.5					○				
		060102FL-F	<0.2	0.03-0.08	0.1-0.5					○				
		060104FR-F	<0.4	0.03-0.08	0.1-0.5					○				
	060104FL-F	<0.4	0.03-0.08	0.1-0.5					○					
		TPEH 080201FR-F	<0.1	0.01-0.10	0.1-0.8					○				
		080201FL-F	<0.1	0.01-0.10	0.1-0.8					○				
		080202FR-F	<0.2	0.01-0.10	0.1-0.8					○				
		080202FL-F	<0.2	0.01-0.10	0.1-0.8					○				
		080204FR-F	<0.4	0.01-0.10	0.1-0.8					○				
	080204FL-F	<0.4	0.01-0.10	0.1-0.8					○					
		TPEH 090201FR-F	<0.1	0.01-0.10	0.1-0.8					○				
		090201FL-F	<0.1	0.01-0.10	0.1-0.8					○				
		090202FR-F	<0.2	0.01-0.10	0.1-0.8					○				
		090202FL-F	<0.2	0.01-0.10	0.1-0.8					○				
		090204FR-F	<0.4	0.01-0.10	0.1-0.8					○				
	090204FL-F	<0.4	0.01-0.10	0.1-0.8					○					
		TPEH 110302FR-F	<0.2	0.01-0.12	0.2-0.8					●				
110302FL-F		<0.2	0.01-0.12	0.2-0.8					●					
110304FR-F		<0.4	0.01-0.12	0.2-0.8					●					
110304FL-F		<0.4	0.01-0.12	0.2-0.8					●					
110308FR-F		<0.8	0.01-0.12	0.2-0.8					●					
110308FL-F		<0.8	0.01-0.12	0.2-0.8					●					
Low feed		TCET 0802003FR-M	<0.03	0.01-0.08	0.5-2.5					○				
		0802003FL-M	<0.03	0.01-0.08	0.5-2.5					○				
		080201FR-M	<0.1	0.01-0.08	0.5-2.5					○				
		080201FL-M	<0.1	0.01-0.08	0.5-2.5					○				
		080202FR-M	<0.2	0.01-0.08	0.5-2.5					○				
	080202FL-M	<0.2	0.01-0.08	0.5-2.5					○					
		TCET 1103003FR-M	<0.03	0.02-0.10	0.5-4.0					●				
		1103003FL-M	<0.03	0.02-0.10	0.5-4.0					●				
		110301FR-M	<0.1	0.02-0.10	0.5-4.0					●				
		110301FL-M	<0.1	0.02-0.10	0.5-4.0					●				
		110302FR-M	<0.2	0.02-0.10	0.5-4.0					●				
		110302FL-M	<0.2	0.02-0.10	0.5-4.0					●				
		110304FR-M	<0.4	0.02-0.10	0.5-4.0					●				
		110304FL-M	<0.4	0.02-0.10	0.5-4.0					●				

Marked : ● Stock available ○ Non-stocked standard

Positive 35° (V) Rhombic Inserts

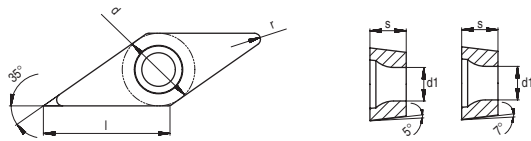

Dimensions (mm)				
Type	d	l	s	d1
VB_1103_	6.35	11.07	3.18	2.8
VB_1604_	9.52	16.61	4.76	4.4
VC_1103_	6.35	11.07	3.18	2.8
VC_1604_	9.52	16.61	4.76	4.4

Inserts	Type	r (mm)	Recommended parameters		Grades										
			f (mm/rev)	ap (mm)	AC150P	AC200P	AC250P	AC350P	AP301M	AC150K	ACK15A	AW100K	APT100S		
Finishing		VBGT 110301E-UF	0.1	0.02-0.15	0.10-1.4					○					
		110302E-UF	0.2	0.02-0.15	0.20-1.4					●					○
		110304E-UF	0.4	0.03-0.20	0.20-1.4					○					●
		160401E-UF	0.1	0.02-0.15	0.10-1.4					○					●
		160402E-UF	0.2	0.02-0.15	0.20-1.4					●					○
		VBGT 110301F-UF	0.1	0.02-0.15	0.10-1.4					●					
		110302F-UF	0.2	0.02-0.15	0.20-1.4					●					
		110304F-UF	0.4	0.03-0.20	0.20-1.4					●					
		160401F-UF	0.1	0.02-0.15	0.10-1.4					●					
		160402F-UF	0.2	0.02-0.15	0.20-1.4					●					
		VCGT 110301E-UF	0.1	0.02-0.15	0.10-1.4					●					○
		110302E-UF	0.2	0.02-0.15	0.20-1.4					●					●
		110304E-UF	0.4	0.03-0.20	0.20-1.4					○					○
		VCGT 110301F-UF	0.1	0.02-0.15	0.10-1.4					●					
		110302F-UF	0.2	0.02-0.15	0.20-1.4					●					
		110304F-UF	0.4	0.03-0.20	0.20-1.4					●					
		VBMT 110304E-PB1	0.4	0.04-0.14	0.30-1.4	○	○	○		●					
		110308E-PB1	0.8	0.09-0.28	0.60-1.4	○	○	○		●					
		160402E-PB1	0.2	0.02-0.07	0.15-2.1	○	○	○		●					
		160404E-PB1	0.4	0.04-0.14	0.30-2.1	●	●	○		●					
160408E-PB1		0.8	0.09-0.28	0.60-2.1	●	●	○		○						
	VCMT 160404E-PB1	0.4	0.04-0.14	0.30-2.1	○		○		○						
	160408E-PB1	0.8	0.09-0.28	0.60-2.1	○		○		○						
Semifinishing		VBMT 110304E-PC2	0.4	0.05-0.16	0.35-2.1	●	○	○		●					●
		110308E-PC2	0.8	0.10-0.32	0.70-2.1	○	○	○		○					○
		160404E-PC2	0.4	0.05-0.16	0.35-3.1	●	○	●		●					●
		160408E-PC2	0.8	0.10-0.32	0.70-3.1	●	●	●		●					●
		160412E-PC2	1.2	0.16-0.48	1.05-3.1	●	○	○		○					●
		VCMT 110304E-PC2	0.4	0.05-0.16	0.35-2.1	●	○	●		○					
		110308E-PC2	0.8	0.10-0.32	0.70-2.1	○		○		○					
		160404E-PC2	0.4	0.05-0.16	0.35-3.1	○		○		●					
		160408E-PC2	0.8	0.10-0.32	0.70-3.1	●		○		○					

Marked : ● Stock available ○ Non-stocked standard

Positive 35° (V) Rhombic Inserts

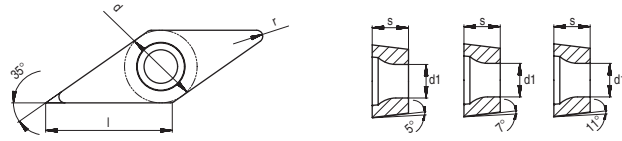

Dimensions (mm)				
Type	d	l	s	d1
VB_1103_	6.35	11.07	3.18	2.8
VB_1604_	9.52	16.61	4.76	4.4
VC_1103_	6.35	11.07	3.18	2.8
VC_1604_	9.52	16.61	4.76	4.4
VC_2205_	12.7	22.14	5.56	5.5
VP_2205_	12.7	22.14	5.56	5.5

Inserts Left-hand shown where it's applicable	Type	r (mm)	Recommended parameters		Grades														
			f (mm/rev)	ap (mm)	AC150P	AC200P	AC250P	AC350P	AP301M	AC150K	ACK15A	AW100K	APT100S						
Semifinishing		VCGT 110302F-NC2	0.2	0.02-0.10	0.16-2.8														
		110304F-NC2	0.4	0.05-0.20	0.32-2.8														
		160404F-NC2	0.4	0.05-0.20	0.32-4.2														
		160408F-NC2	0.8	0.10-0.40	0.64-4.2														
		160412F-NC2	1.2	0.14-0.60	0.96-4.2														
	220530F-NC2	3.0	0.36-1.50	2.40-5.5															
		VPGT 220520E-NC2	2.0	0.24-1.0	1.60-5.5														
		VPGT 220520F-NC2	2.0	0.24-1.0	1.60-5.5														
		VBMT 160404E-KC2	0.4	0.06-0.18	0.40-3.3	●	○	●				●	○						
	Finishing		110301FR-F	<0.1	0.01-0.18	0.1-0.3						●							
110301FL-F			<0.1	0.01-0.18	0.1-0.3						●								
110302FR-F			<0.2	0.01-0.18	0.1-0.3						●								
110302FL-F			<0.2	0.01-0.18	0.1-0.3						●								
VBET 1103003FR-F			<0.03	0.01-0.18	0.1-0.3						●								
110303FL-F			<0.03	0.01-0.18	0.1-0.3						●								
Low feed		VBET 110301FR-M	<0.1	0.01-0.06	0.2-2.0						●								
		110301FL-M	<0.1	0.01-0.06	0.2-2.0						●								
		110302FR-M	<0.2	0.01-0.06	0.2-2.0						●								
		110302FL-M	<0.2	0.01-0.06	0.2-2.0						●								
		110304FR-M	<0.4	0.01-0.06	0.2-2.0						●								

Marked : ● Stock available ○ Non-stocked standard

Positive 35° (V) Rhombic Inserts

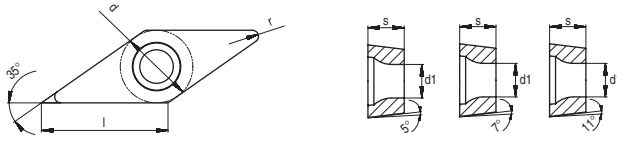

Dimensions (mm)				
Type	d	l	s	d1
VB_1103_	6.35	11.07	3.18	2.8
VB_1604_	9.52	16.61	4.76	4.4
VC_1103_	6.35	11.07	3.18	2.8
VP_0802_	4.76	8.3	2.38	2.3
VP_1103_	6.35	11.07	3.18	2.8

Inserts Left-hand shown where it's applicable	Type	r (mm)	Recommended parameters		Grades										
			f (mm/rev)	ap (mm)	AC150P	AC200P	AC250P	AC350P	AP301M	AC150K	ACK15A	AW100K	APT100S		
Finishing		VCET 110301FR-F	<0.1	0.01-0.18	0.1-0.3					●					
		110301FL-F	<0.1	0.01-0.18	0.1-0.3					●					
		110302FR-F	<0.2	0.01-0.18	0.1-0.3					●					
		110302FL-F	<0.2	0.01-0.18	0.1-0.3					●					
		110304FR-F	<0.4	0.01-0.18	0.1-0.3					●					
		110304FL-F	<0.4	0.01-0.18	0.1-0.3					●					
	Low feed		VPET 080201FR-F	<0.1	0.02-0.15	0.05-0.2					○				
			080201FL-F	<0.1	0.02-0.15	0.05-0.2					○				
			080202FR-F	<0.2	0.02-0.15	0.05-0.2					○				
			080202FL-F	<0.2	0.02-0.15	0.05-0.2					○				
			VPET 080201FR-M	<0.1	0.01-0.06	0.2-1.5					○				
			080201FL-M	<0.1	0.01-0.06	0.2-1.5					○				
080202FR-M			<0.2	0.01-0.06	0.2-1.5					○					
080202FL-M			<0.2	0.01-0.06	0.2-1.5					○					
VPET 110301FR-M			<0.1	0.01-0.06	0.2-2.0					○					
110301FL-M			<0.1	0.01-0.06	0.2-2.0					○					
		110302FR-M	<0.2	0.01-0.06	0.2-2.0					○					
		110302FL-M	<0.2	0.01-0.06	0.2-2.0					○					
		110304FR-M	<0.4	0.01-0.06	0.2-2.0					○					
		110304FL-M	<0.4	0.01-0.06	0.2-2.0					○					
		VBET 1103003FR-Y	<0.03	0.08-0.22	0.5-1.8					○					
		1103003FL-Y	<0.03	0.08-0.22	0.5-1.8					○					
		110301FR-Y	<0.1	0.08-0.22	0.5-1.8					○					
		110301FL-Y	<0.1	0.08-0.22	0.5-1.8					○					
	110302FR-Y	<0.2	0.08-0.22	0.5-1.8					○						
	110302FL-Y	<0.2	0.08-0.22	0.5-1.8					○						
	110304FR-Y	<0.4	0.08-0.22	0.5-1.8					○						
	110304FL-Y	<0.4	0.08-0.22	0.5-1.8					○						
	VBET 160402FR-Y	<0.2	0.1-0.25	0.8-2.0					○						
	160402FL-Y	<0.2	0.1-0.25	0.8-2.0					○						
	160404FR-Y	<0.4	0.1-0.25	0.8-2.0					○						
	160404FL-Y	<0.4	0.1-0.25	0.8-2.0					○						
	160408FR-Y	0.8	0.1-0.25	0.8-2.0					○						
	160408FL-Y	0.8	0.1-0.25	0.8-2.0					○						



Marked : ● Stock available ○ Non-stocked standard

Turning inserts

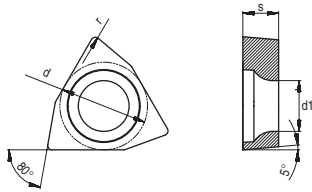
Positive 80° (W) Trigon Inserts



Dimensions (mm)				
Type	d	l	s	d1
WB_0601_	3.97	3.52	1.59	2.3
WB_0802_	4.76	4.78	2.38	2.3

Inserts Left-hand shown where it's applicable	Type	r (mm)	Recommended parameters		Grades											
			f (mm/rev)	ap (mm)	AC150P	AC200P	AC250P	AC350P	AP301M	AC150K	ACK15A	AW100K	AP100S			
Finishing		WBET 0601003FR-F	<0.03	0.05-0.08	0.1-0.8						○					
		0601003FL-F	<0.03	0.05-0.08	0.1-0.8						○					
		060101FR-F	<0.1	0.05-0.08	0.1-0.8						○					
		060101FL-F	<0.1	0.05-0.08	0.1-0.8						○					
		060102FR-F	<0.2	0.05-0.08	0.1-0.8						○					
		060102FL-F	<0.2	0.05-0.08	0.1-0.8						○					
		060104FR-F	<0.4	0.05-0.08	0.1-0.8						○					
		060104FL-F	<0.4	0.05-0.08	0.1-0.8						○					
		WBET 0802003FR-F	<0.03	0.05-0.08	0.1-0.8						○					
		0802003FL-F	<0.03	0.05-0.08	0.1-0.8						○					
		080201FR-F	<0.1	0.05-0.08	0.1-0.8						○					
		080201FL-F	<0.1	0.05-0.08	0.1-0.8						○					
		080202FR-F	<0.2	0.05-0.08	0.1-0.8						○					
		080202FL-F	<0.2	0.05-0.08	0.1-0.8						○					
	080204FR-F	<0.4	0.05-0.08	0.1-0.8						○						
	080204FL-F	<0.4	0.05-0.08	0.1-0.8						○						

Positive Round Turning Inserts

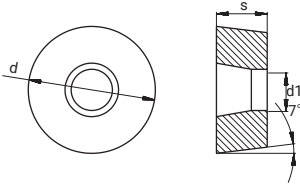

Dimensions (mm)			
Type	s	d	d1
RCGT_0803_	3.18	8.0	3.4
RCGT_1003_	3.18	10.0	4.4
RCGT_10T3_	3.97	10.0	4.4
RCTX_1003_	3.18	10.0	3.6
RCTX_1204_	4.76	12.0	4.2

Dimensions (mm)			
Type	s	d	d1
RCTX_1606_	6.35	16.0	5.2
RCTX_2006_	6.35	20.0	6.5
RCTX_2507_	7.94	25.0	7.2
RCTX_3209_	9.52	32.0	9.6

Inserts	Type	r (mm)	Recommended parameters		Grades															
			f (mm/rev)	ap (mm)	AC150P	AC200P	AC250P	AC350P	AP301M	AC150K	ACK15A	AW100K	APT100S							
Semifinishing	RCGT 0803MOF-NC2	4	0.10-1.00	0.70-3.3																
	1003MOF-NC2	5	0.20-1.30	0.90-4.0																
	10T3MOF-NC2	5	0.20-1.30	0.90-4.0																
Finishing	RCTX 2006MOS-PD8	10	0.48-0.90	3.5-9.0	○	○	○													
	2507MOS-PD8	12.5	0.55-1.20	4.0-12.0	○	●	○													
	3209MOS-PD8	16	0.65-1.50	5.0-15.0	○	○	○													
Medium	RCTX 100300S	5	0.25-0.50	1.5-4.0	○		●	○												
	120400S	6	0.30-0.60	2.5-5.0	●		●	○												
	160600S	8	0.40-0.75	3.0-7.0	●		○	○												
	200600S	10	0.48-0.90	3.5-9.0	●		○	●												
	250700S	12.5	0.55-1.20	4.0-12.0	○		○	○												
	320900S	16	0.65-1.50	5.0-15.0	●		○	○												

Marked : ● Stock available ○ Non-stocked standard

Turning inserts

Negative Insert Geometry
Ap, F Application Range

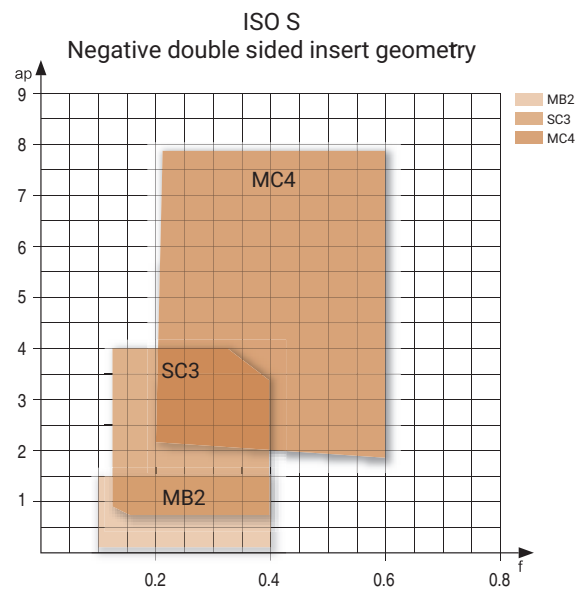
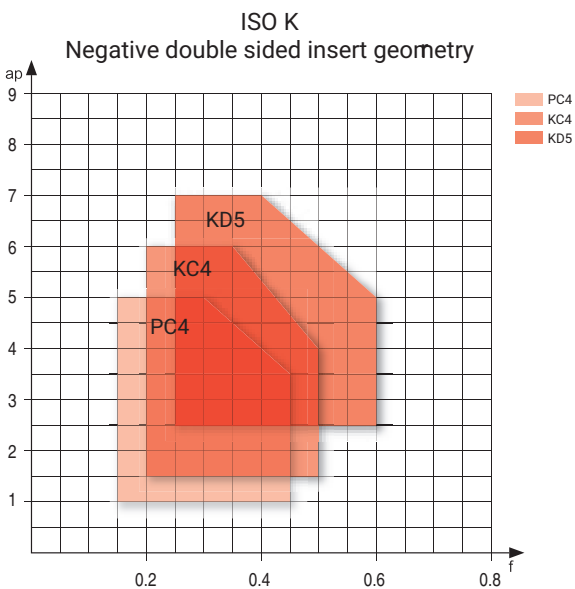
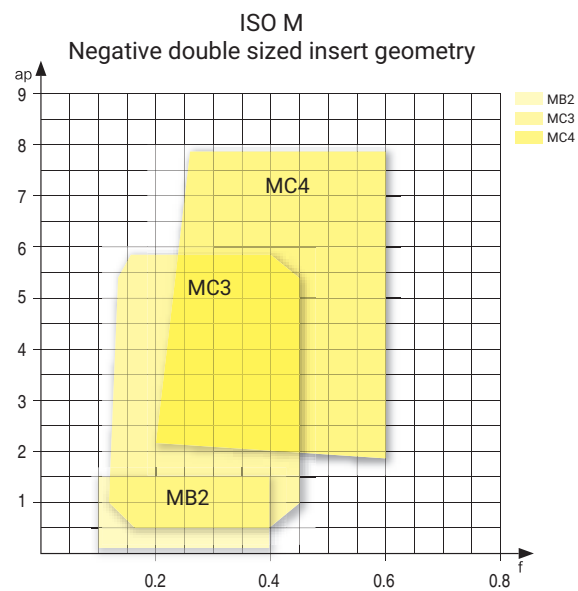
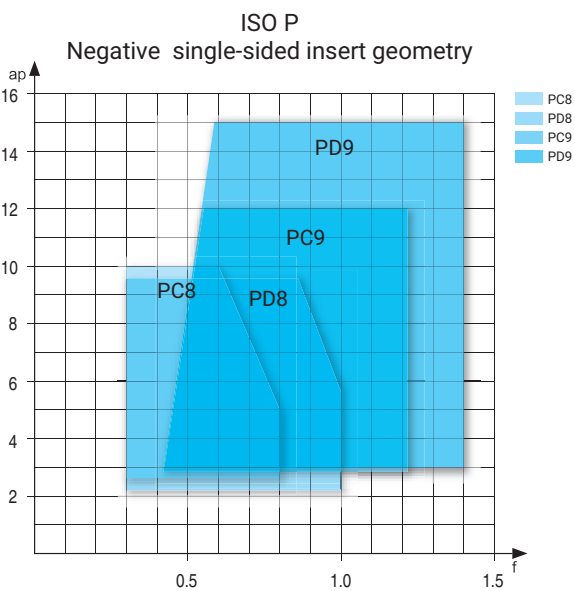
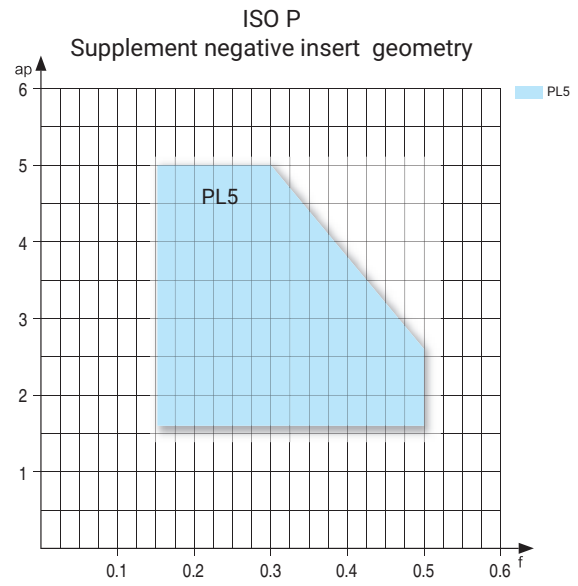
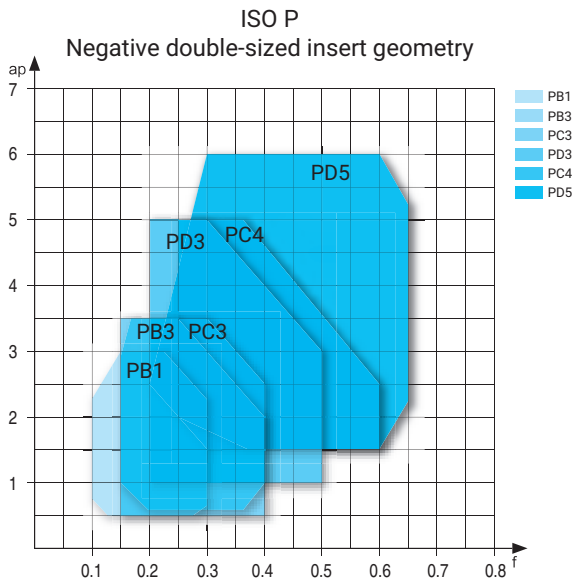

**Positive Insert Geometry
Ap, F Application Range**

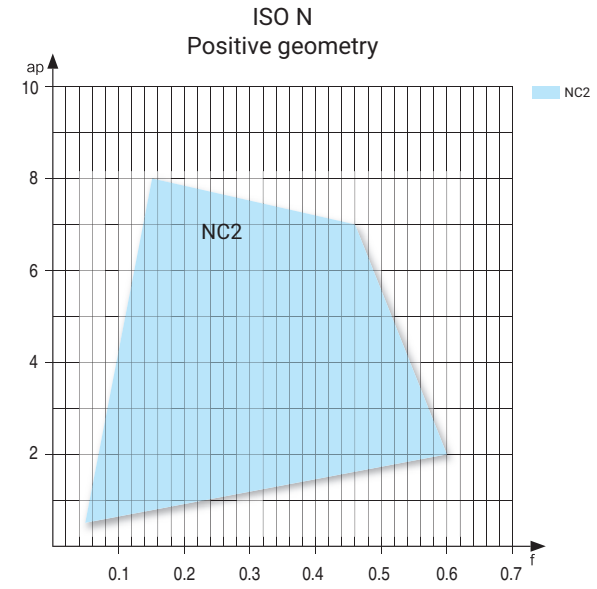
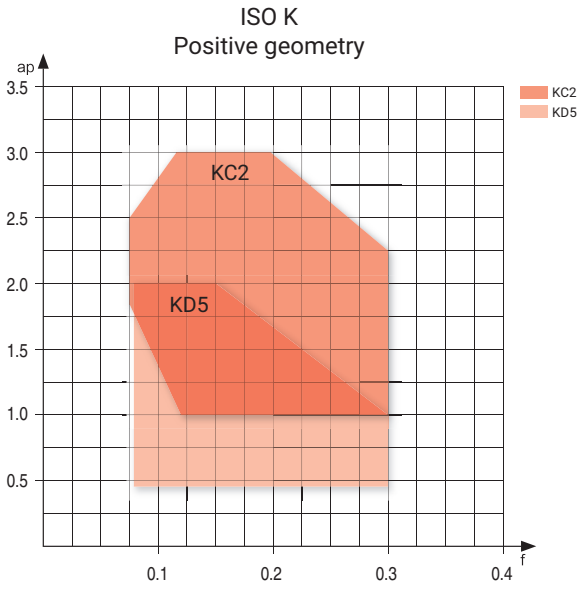
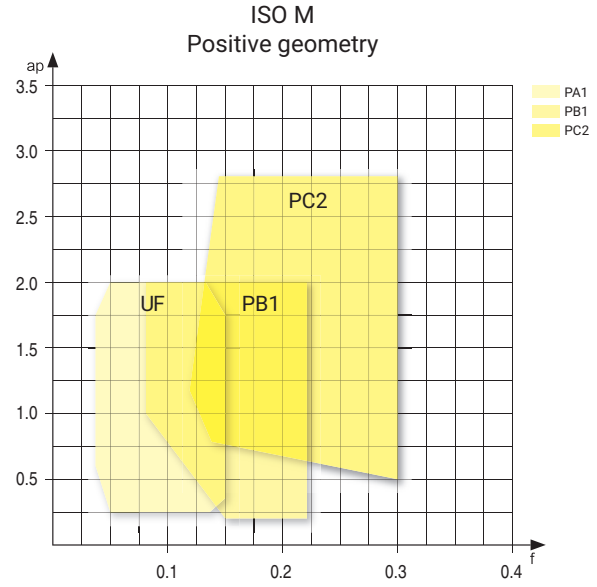
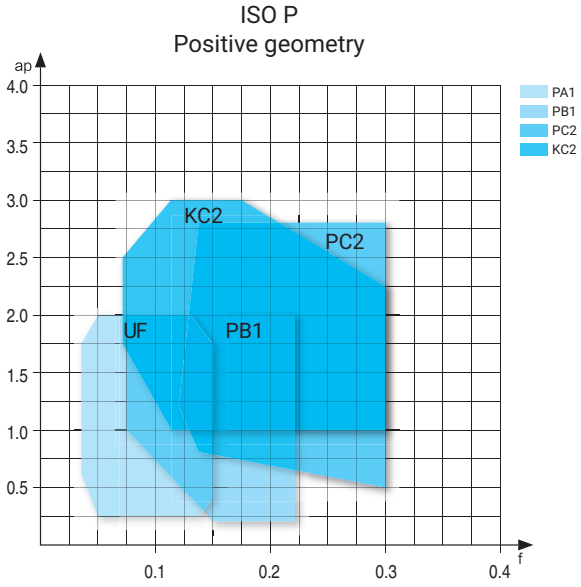

Swiss Tool Geometry Ap, F Application Range

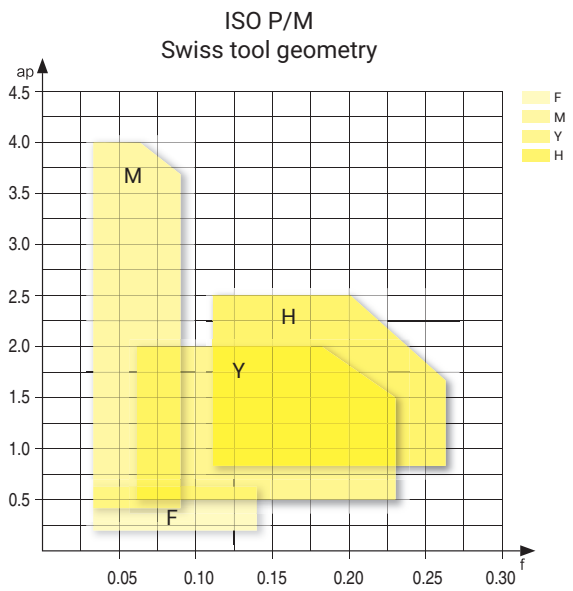

Cutting Parameter Recommendation Table -Negative inserts

Materials				Turning grade application range																																		
ISO	Workpiece material		Brinell hardness (HB)	Tensile strength Rm(N/mm ²)	Initial value of cutting speed Vc(m/min)																																	
					AC150P	AC200P	AC250P	AC350P	AP301M	AC150K	ACK15A	AW100K	AP100S	f(mm/rev)																								
					0.1	0.4	0.6	0.1	0.4	0.6	0.1	0.4	0.6	0.1	0.3	0.5	0.1	0.4	0.6	0.1	0.4	0.6	0.1	0.2	0.4	0.1	0.3	0.5										
P	Unalloyed steel	C ≤ 0.25%	Annealed	125	428	485	360	270	400	310	230	380	260	210	250	170	140																					
		0.25 < C ≤ 0.55%	Annealed	190	639	370	270	210	320	240	190	280	200	150	200	135	110																					
		0.25 < C ≤ 0.55%	Heat-treated	210	708	260	220	170	250	200	160	200	160	135	150	125	90																					
		C > 0.55%	Annealed	190	639	270	220	160	270	200	150	240	160	125	170	110	90																					
		C > 0.55%	Heat-treated	300	1013	210	180	150	210	160	150	160	120	110	125	75	65																					
		Free cutting steel (short-chip)	Annealed	220	745	440	310	250	360	270	210	340	220	175	220	145	115																					
	Low-alloyed steel		Annealed	175	591	350	260	220	290	210	180	240	175	135	200	165	150																					
			Heat-treated	300	1013	220	170	150	190	160	140	100	85	135	90	70																						
			Heat-treated	380	1282	160	120	100	180	150	120	100	70	55	90	65	45																					
			Heat-treated	430	1477	90	70		120	100																												
High-alloyed steel and high-alloyed tool steel		Annealed	200	675	330	230	150	260	200	180	210	145	85	180	150	85																						
		Hardened and tempered	300	1013	230	140	110	200	180	160	130	85	65	110	85	65																						
		Hardened and tempered	400	1361	80	70		130	120																													
Stainless steel		Ferritic/martensitic, annealed	200	675				220	170	160	180	150	120	150	120	95																						
		Martensitic, heat-treated	330	1114				160	130	100	140	100	70	110	80	60																						
M	Stainless steel	Austenitic, quench hardened	200	675										200	160	130																				240	190	150
		Austenitic, precipitation hardened (PH)	300	1013											160	130	70																			150	85	
		Austenitic/ferritic, duplex	230	778											180	140	110																				170	145
K	Malleable cast iron	Ferritic	200	400																																		
		Pearlitic	260	700																																		
	Grey cast iron	Low tensile strength	180	200																																		
		High tensile strength/austenitic	245	350																																		
	Nodular cast iron	Ferritic	155	400																																		
Pearlitic		265	700																																			
	GGV(CGI)	230	400																																			
N	Wrought aluminium alloys	Non-aging alloy	30	-																																		
		Aged alloy	100	340																																		
	Cast aluminium alloys	≤ 12% Si, non-aging alloy	75	260																																		
		≤ 12% Si, aged alloy	90	310																																		
		> 12% Si, non-aging	130	450																																		
	Magnesium alloys		70	250																																		
	Copper and copper alloys (bronze/brass)	Unalloyed, electrolytic copper	100	340																																		
Brass, bronze, red brass		90	310																																			
Cu alloys, short-chip		110	380																																			
High tensile, Ampco alloy		300	1010																																			
S	Heat-resistant alloys	Fe-based	Annealed	200	680																																	
			Aged	280	940																																	
		Ni or Co based	Annealed	250	840																																	
			Aged	350	1180																																	
		Cast	320	1080																																		
	Titanium alloys	Pure titanium	200	680																																	200	180
α and β alloys, aged		375	1260																																	90	55	45
β alloys		410	1400																																	55	35	30
Tungsten alloys		1177	300	1010																																		
Molybdenum alloys		1262	300	1010																																		
H	Hardened steel	Hardened and tempered	50HRC																																			
		Hardened and tempered	55HRC																																			
		Hardened and tempered	60HRC																																			
	Hardened cast steel	Hardened and tempered	50HRC																																			

*The recommended cutting data always refer to general cutting conditions. The actual selection should be adjusted according to the factors such as machine rigidity, tool body, workpiece conditions and coolant.







Cutting Parameter Recommendation Table -Negative inserts

		Materials		Turning grade application range																																		
ISO	Workpiece material		Brinell hardness (HB)	Tensile strength Rm(N/mm²)	Initial value of cutting speed Vc(m/min)																																	
					AC150P	AC200P	AC250P	AC350P	AP301M	AC150K	ACK15A	AW100K	AP100S	f(mm/rev)																								
					0.1 0.4 0.6		0.1 0.4 0.6		0.1 0.4 0.6		0.1 0.4 0.6		0.1 0.3 0.5		0.1 0.4 0.6		0.1 0.4 0.6		0.1 0.2 0.4		0.1 0.3 0.5																	
					0.1	0.4	0.6	0.1	0.4	0.6	0.1	0.4	0.6	0.1	0.4	0.6	0.1	0.3	0.5	0.1	0.4	0.6	0.1	0.4	0.6	0.1	0.2	0.4	0.1	0.3	0.5							
P	Unalloyed steel	C ≤ 0.25%	Annealed	125	428	465	400	330	400	310	230	360	310	260	230	150	120																					
		0.25 < C ≤ 0.55%	Annealed	190	639	360	330	260	330	250	200	290	250	190	180	115	100																					
		0.25 < C ≤ 0.55%	Heat-treated	210	708	270	240	220	250	200	160	200	180	160	130	115	85																					
		C > 0.55%	Annealed	190	639	330	300	290	260	210	170	250	220	210	150	100	85																					
		C > 0.55%	Heat-treated	300	1013	210	180	170	220	180	150	160	130	120	115	65	55																					
		Free cutting steel (short-chip)	Annealed	220	745	440	400	380	360	280	210	320	290	275	210	135	105																					
	Low-alloyed steel	Annealed		175	591	350	310	300	290	200	180	260	240	220	190	155	130																					
		Heat-treated		300	1013	200	170	160	240	170	160	135	120	100	125	80	65																					
		Heat-treated		380	1282	120	100	90	200	150	140	100	85	65	90	65	45																					
		Heat-treated		430	1477	80	70		140	130		65	55																									
	High-alloyed steel and high-alloyed tool steel	Annealed		200	675	320	290	280	260	200	180	270	240	220	170	140	75																					
		Hardened and tempered		300	1013	200	170	150	200	180	160	170	140	120	100	80	60																					
Hardened and tempered		400	1361	80	70		130	120		65	55																											
Stainless steel	Ferritic/martensitic, annealed		200	675						250	220	210	190	170	150	120	100	90																				
	Martensitic, heat-treated		330	1114						130	110	100	90	80	60	70	60	50																				
M	Stainless steel	Austenitic, quench hardened		200	675																																	
		Austenitic, precipitation hardened (PH)		300	1013																																	
		Austenitic/ferritic, duplex		230	778																																	
K	Malleable cast iron	Ferritic		200	400																																	
		Pearlitic		260	700																																	
	Grey cast iron	Low tensile strength		180	200																																	
		High tensile strength/austenitic		245	350																																	
	Nodular cast iron	Ferritic		155	400																																	
Pearlitic		265	700																																			
		GGV(CGI)		230	400																																	
N	Wrought aluminium alloys	Non-aging alloy		30	-																																	
		Aged alloy		100	340																																	
	Cast aluminium alloys	≤ 12% Si, non-aging alloy		75	260																																	
		≤ 12% Si, aged alloy		90	310																																	
		> 12% Si, non-aging		130	450																																	
	Magnesium alloys			70	250																																	
	Copper and copper alloys (bronze/brass)	Unalloyed, electrolytic copper		100	340																																	
Brass, bronze, red brass		90	310																																			
Cu alloys, short-chip		110	380																																			
High tensile, Ampco alloy		300	1010																																			
S	Heat-resistant alloys	Fe-based	Annealed	200	680																																	
			Aged	280	940																																	
		Ni or Co based	Annealed	250	840																																	
			Aged	350	1180																																	
	Titanium alloys	Pure titanium		200	680																																	
		α and β alloys, aged		375	1260																																	
Tungsten alloys	1177		300	1010																																		
Molybdenum alloys	1262		300	1010																																		
H	Hardened steel	Hardened and tempered		50HRC																																		
		Hardened and tempered		55HRC																																		
		Hardened and tempered		60HRC																																		
	Hardened cast steel	Hardened and tempered		50HRC																																		

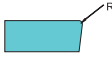
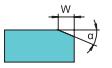
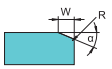
*The recommended cutting data always refer to general cutting conditions. The actual selection should be adjusted according to the factors such as machine rigidity, tool body, workpiece conditions and coolant.

PCBN Insert Denomination System

CNGA 120408	-	S	010	20	-	SL	-	1	-	CB	PB30
1		2	3	4		5		6		7	8

1-Standard ISO denomination system	2-Cutting edge shape	3-T-land width	4-T-land angle
	<p>E---Honed </p> <p>T-Land without honing </p> <p>S---Land with honed </p> <p>F---Sharp </p>	<p>005---0.05mm 010---0.10mm 015---0.15mm 020---0.20mm</p>	<p>10---10° 15---15° 20---20° 25---25°</p>
5-CBN insert structure	6-Number of cutting edge	7-Cutting edge preparation	8-Grade
<p>FT- Full face CBN </p> <p>SD- Solid CBN </p> <p>SL- Small size tipped CBN </p> <p>NL- Standard-tipped CBN (Regrindable) </p>	<p>1---One cutting edge 2---Two cutting edges 3---Three cutting edges</p>	<p>CB---With chip breaker WG---With wiper edge "- " ---Without chip breaker</p>	<p>PB30--- Low content CBN PB60---Medium content CBN PB90---High content CBN</p>

PCBN Insert Grade Introduction

Grade	Feature	Application
PB30	Well balanced wear resistance and shock-resistance	Good versatilely. Suitable for continuous and light interrupted cutting of hardened steel
PB60	Excellent toughness	Mainly applied in medium interrupted cutting of hardened steel,interrupted and continuous cutting of powder metal and cast iron cutting.
PB90	Good wear resistance, toughness, and shock-resistance	K-mainly applied in cast iron cutting H-heavy interrupted cutting of hardened steel and powder metal machining

PCBN Recommended Cutting Parameter

Grade	Material	Hardness	Cutting speed Vc(m/min)	Feed fn(mm/rev)	Cutting depth ap(mm)	Recommended application
PB30	Hardened steel	HRC58-62	150-250	0.03-0.2	0.05-0.3	Continuous
PB60	Hardened steel	HRC55-60	50-150	0.03-0.2	0.05-0.5	Interrupted
	Cast iron	HB180-220	150-450	0.03-0.3	0.30-0.5	Continuous / Interrupted
	Powder metal	-	200-500	0.03-0.3	0.10-0.3	Continuous / Interrupted
PB90	Hardened steel	HRC55-60	30-120	0.03-0.2	0.05-0.5	Heavy interrupted
	Cast iron	HB180-220	150-450	0.03-0.3	0.30-0.5	Continuous / Interrupted
	Powder metal	-	300-800	0.03-0.3	0.10-0.3	Continuous / Interrupted

Grade Application Guide

PCBN grade applications						
Material Group	Materials	ISO	Uncoated			ISO
			PB30	PB60	PB90	
P	unalloy steels / Alloyed steels	P01				P01
		P05				P05
		P10				P10
		P15				P15
		P20				P20
		P25				P25
		P30				P30
		P35				P35
		P40				P40
		P45				P45
		P50				P50
		M	Stainless steels	M01		
M05						M05
M10						M10
M15						M15
M20						M20
M25						M25
M30						M30
M35						M35
M40						M40
M45						M45
K	Cast iron	K01				K01
		K05				K05
		K10				K10
		K15				K15
		K20		PB60		K20
		K25			PB90	K25
		K30				K30
		K35				K35
		K40				K40
		K45				K45
		K50				K50
N	Aluminum/ Aluminum alloys	N01				N01
		N05				N05
		N10				N10
		N15				N15
		N20				N20
		N25				N25
		N30				N30
S	Heat resistant alloys	S01				S01
		S05				S05
		S10				S10
		S15				S15
		S20				S20
		S25				S25
		S30				S30
		S35				S35
		S40				S40
		H	Hardened steels/ Chilled cast iron	H01		
H05						H05
H10	PB30					H10
H15				PB60		H15
H20					PB90	H20
H25						H25
H30						H30

Turning inserts

Negative 80° (CN)

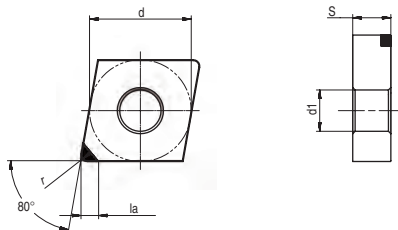

Dimensions (mm)				
Type	d	s	la	d1
CN_1204_	12.7	4.76	2.2	5.16

Inserts	Type	r (mm)	Recommended parameters		Grade		
			f (mm/rev)	ap (mm)	PB30	PB60	PB90
	CNGA 120402-S01020-SL-1	0.2	0.03-0.3	0.05-0.5	●	●	●
	CNGA 120404-S01020-SL-1	0.4	0.03-0.3	0.05-0.5	●	●	●
	CNGA 120408-S01020-SL-1	0.8	0.03-0.3	0.05-0.5	●	●	●
	CNGA 120412-S01020-SL-1	1.2	0.03-0.3	0.05-0.5	●	●	●
	CNGA 120402-S01020-SL-2	0.2	0.03-0.3	0.05-0.5	●	●	●
	CNGA 120404-S01020-SL-2	0.4	0.03-0.3	0.05-0.5	●	●	●
	CNGA 120408-S01020-SL-2	0.8	0.03-0.3	0.05-0.5	●	●	●
	CNGA 120412-S01020-SL-2	1.2	0.03-0.3	0.05-0.5	●	●	●
	CNGA 120402-S01020-SL-4	0.2	0.03-0.3	0.05-0.5	●	●	●
	CNGA 120404-S01020-SL-4	0.4	0.03-0.3	0.05-0.5	●	●	●
	CNGA 120408-S01020-SL-4	0.8	0.03-0.3	0.05-0.5	●	●	●
	CNGA 120412-S01020-SL-4	1.2	0.03-0.3	0.05-0.5	●	●	●

Marked : ● Stock available ○ Non-stocked standard

Negative 55° (DN)

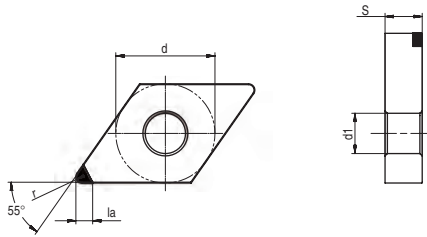

Dimensions (mm)				
Type	d	s	la	d1
DN_1504_	12.7	4.76	2.2	5.16
DN_1506_	12.7	6.35	2.2	5.16

Inserts	Type	r (mm)	Recommended parameters		Grade		
			f (mm/rev)	ap (mm)	PB30	PB60	PB90
	DNGA 150402-S01020-SL-1	0.2	0.03-0.3	0.05-0.5	●	●	●
	DNGA 150404-S01020-SL-1	0.4	0.03-0.3	0.05-0.5	●	●	●
	DNGA 150408-S01020-SL-1	0.8	0.03-0.3	0.05-0.5	●	●	●
	DNGA 150412-S01020-SL-1	1.2	0.03-0.3	0.05-0.5	●	●	●
	DNGA 150602-S01020-SL-1	0.2	0.03-0.3	0.05-0.5	●	●	●
	DNGA 150604-S01020-SL-1	0.4	0.03-0.3	0.05-0.5	●	●	●
	DNGA 150608-S01020-SL-1	0.8	0.03-0.3	0.05-0.5	●	●	●
	DNGA 150612-S01020-SL-1	1.2	0.03-0.3	0.05-0.5	●	●	●
	DNGA 150402-S01020-SL-2	0.2	0.03-0.3	0.05-0.5	●	●	●
	DNGA 150404-S01020-SL-2	0.4	0.03-0.3	0.05-0.5	●	●	●
	DNGA 150408-S01020-SL-2	0.8	0.03-0.3	0.05-0.5	●	●	●
	DNGA 150412-S01020-SL-2	1.2	0.03-0.3	0.05-0.5	●	●	●
	DNGA 150602-S01020-SL-2	0.2	0.03-0.3	0.05-0.5	●	●	●
	DNGA 150604-S01020-SL-2	0.4	0.03-0.3	0.05-0.5	●	●	●
	DNGA 150608-S01020-SL-2	0.8	0.03-0.3	0.05-0.5	●	●	●
	DNGA 150612-S01020-SL-2	1.2	0.03-0.3	0.05-0.5	●	●	●
	DNGA 150402-S01020-SL-4	0.2	0.03-0.3	0.05-0.5	●	●	●
	DNGA 150404-S01020-SL-4	0.4	0.03-0.3	0.05-0.5	●	●	●
	DNGA 150408-S01020-SL-4	0.8	0.03-0.3	0.05-0.5	●	●	●
	DNGA 150412-S01020-SL-4	1.2	0.03-0.3	0.05-0.5	●	●	●
	DNGA 150602-S01020-SL-4	0.2	0.03-0.3	0.05-0.5	●	●	●
	DNGA 150604-S01020-SL-4	0.4	0.03-0.3	0.05-0.5	●	●	●
	DNGA 150608-S01020-SL-4	0.8	0.03-0.3	0.05-0.5	●	●	●
	DNGA 150612-S01020-SL-4	1.2	0.03-0.3	0.05-0.5	●	●	●

Marked : ● Stock available ○ Non-stocked standard

Negative 90° (SN)

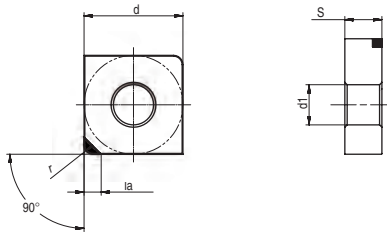

Dimensions (mm)				
Type	d	s	la	d1
SN_1204_	12.7	4.76	2.2	5.16

Inserts	Type	r (mm)	Recommended parameters		Grade		
			f (mm/rev)	ap (mm)	PB30	PB60	PB90
	SNGA 120402-S01020-SL-1	0.2	0.03-0.3	0.05-0.5	●	●	●
	SNGA 120404-S01020-SL-1	0.4	0.03-0.3	0.05-0.5	●	●	●
	SNGA 120408-S01020-SL-1	0.8	0.03-0.3	0.05-0.5	●	●	●
	SNGA 120412-S01020-SL-1	1.2	0.03-0.3	0.05-0.5	●	●	●
	SNGA 120402-S01020-SL-4	0.2	0.03-0.3	0.05-0.5	●	●	●
	SNGA 120404-S01020-SL-4	0.4	0.03-0.3	0.05-0.5	●	●	●
	SNGA 120408-S01020-SL-4	0.8	0.03-0.3	0.05-0.5	●	●	●
	SNGA 120412-S01020-SL-4	1.2	0.03-0.3	0.05-0.5	●	●	●
	SNGA 120402-S01020-SL-8	0.2	0.03-0.3	0.05-0.5	●	●	●
	SNGA 120404-S01020-SL-8	0.4	0.03-0.3	0.05-0.5	●	●	●
	SNGA 120408-S01020-SL-8	0.8	0.03-0.3	0.05-0.5	●	●	●
	SNGA 120412-S01020-SL-8	1.2	0.03-0.3	0.05-0.5	●	●	●

Marked : ● Stock available ○ Non-stocked standard

Negative 60° (TN)

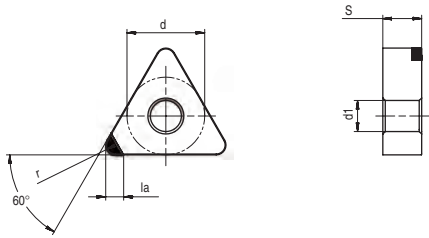

Dimensions (mm)				
Type	d	s	la	d1
TN_1604_	9.52	4.76	2.2	3.81

Turning inserts

Inserts	Type	r (mm)	Recommended parameters		Grade		
			f (mm/rev)	ap (mm)	PB30	PB60	PB90
	TNGA 160402-S01020-SL-1	0.2	0.03-0.3	0.05-0.5	●	●	●
	TNGA 160404-S01020-SL-1	0.4	0.03-0.3	0.05-0.5	●	●	●
	TNGA 160408-S01020-SL-1	0.8	0.03-0.3	0.05-0.5	●	●	●
	TNGA 160412-S01020-SL-1	1.2	0.03-0.3	0.05-0.5	●	●	●
	TNGA 160402-S01020-SL-3	0.2	0.03-0.3	0.05-0.5	●	●	●
	TNGA 160404-S01020-SL-3	0.4	0.03-0.3	0.05-0.5	●	●	●
	TNGA 160408-S01020-SL-3	0.8	0.03-0.3	0.05-0.5	●	●	●
	TNGA 160412-S01020-SL-3	1.2	0.03-0.3	0.05-0.5	●	●	●
	TNGA 160402-S01020-SL-6	0.2	0.03-0.3	0.05-0.5	●	●	●
	TNGA 160404-S01020-SL-6	0.4	0.03-0.3	0.05-0.5	●	●	●
	TNGA 160408-S01020-SL-6	0.8	0.03-0.3	0.05-0.5	●	●	●
	TNGA 160412-S01020-SL-6	1.2	0.03-0.3	0.05-0.5	●	●	●

Marked : ● Stock available ○ Non-stocked standard



Negative 35° (VN)

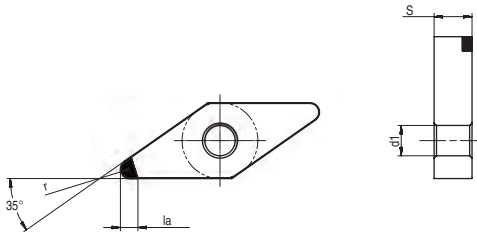

Dimensions (mm)				
Type	d	s	la	d1
VN_1604_	9.52	4.76	2.2	3.81

Inserts	Type	r (mm)	Recommended parameters		Grade		
			f (mm/rev)	ap (mm)	PB30	PB60	PB90
	VNGA 160402-S01020-SL-1	0.2	0.03-0.3	0.05-0.5	●	●	●
	VNGA 160404-S01020-SL-1	0.4	0.03-0.3	0.05-0.5	●	●	●
	VNGA 160408-S01020-SL-1	0.8	0.03-0.3	0.05-0.5	●	●	●
	VNGA 160412-S01020-SL-1	1.2	0.03-0.3	0.05-0.5	●	●	●
	VNGA 160402-S01020-SL-2	0.2	0.03-0.3	0.05-0.5	●	●	●
	VNGA 160404-S01020-SL-2	0.4	0.03-0.3	0.05-0.5	●	●	●
	VNGA 160408-S01020-SL-2	0.8	0.03-0.3	0.05-0.5	●	●	●
	VNGA 160412-S01020-SL-2	1.2	0.03-0.3	0.05-0.5	●	●	●
	VNGA 160402-S01020-SL-4	0.2	0.03-0.3	0.05-0.5	●	●	●
	VNGA 160404-S01020-SL-4	0.4	0.03-0.3	0.05-0.5	●	●	●
	VNGA 160408-S01020-SL-4	0.8	0.03-0.3	0.05-0.5	●	●	●
	VNGA 160412-S01020-SL-4	1.2	0.03-0.3	0.05-0.5	●	●	●

Marked : ● Stock available ○ Non-stocked standard

Negative 80° (WN)

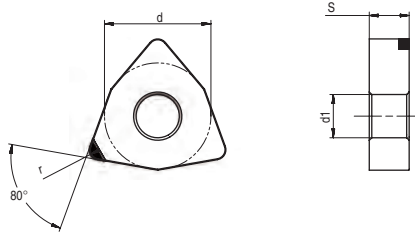

Dimensions (mm)				
Type	d	s	la	d1
WN_0804_	12.7	4.76	2.2	5.16

Inserts	Type	r (mm)	Recommended parameters		Grade		
			f (mm/rev)	ap (mm)	PB30	PB60	PB90
	WNGA 080402-S01020-SL-1	0.2	0.03-0.3	0.05-0.5	●	●	●
	WNGA 080404-S01020-SL-1	0.4	0.03-0.3	0.05-0.5	●	●	●
	WNGA 080408-S01020-SL-1	0.8	0.03-0.3	0.05-0.5	●	●	●
	WNGA 080412-S01020-SL-1	1.2	0.03-0.3	0.05-0.5	●	●	●
	WNGA 080402-S01020-SL-3	0.2	0.03-0.3	0.05-0.5	●	●	●
	WNGA 080404-S01020-SL-3	0.4	0.03-0.3	0.05-0.5	●	●	●
	WNGA 080408-S01020-SL-3	0.8	0.03-0.3	0.05-0.5	●	●	●
	WNGA 080412-S01020-SL-3	1.2	0.03-0.3	0.05-0.5	●	●	●
	WNGA 080402-S01020-SL-6	0.2	0.03-0.3	0.05-0.5	●	●	●
	WNGA 080404-S01020-SL-6	0.4	0.03-0.3	0.05-0.5	●	●	●
	WNGA 080408-S01020-SL-6	0.8	0.03-0.3	0.05-0.5	●	●	●
	WNGA 080412-S01020-SL-6	1.2	0.03-0.3	0.05-0.5	●	●	●

Marked : ● Stock available ○ Non-stocked standard

Positive 80° (CC)

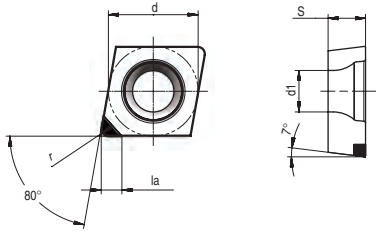

Dimensions (mm)				
Type	d	s	la	d1
CC_0602_	6.35	2.38	2.2	2.8
CC_09T3_	9.52	3.97	2.2	4.4
CC_1204_	12.7	4.76	2.2	5.5

Inserts	Type	r (mm)	Recommended parameters		Grade		
			f (mm/rev)	ap (mm)	PB30	PB60	PB90
	CCGW 060202-S01020-SL-1	0.2	0.03-0.3	0.05-0.5	●	●	●
	CCGW 060204-S01020-SL-1	0.4	0.03-0.3	0.05-0.5	●	●	●
	CCGW 060208-S01020-SL-1	0.8	0.03-0.3	0.05-0.5	●	●	●
	CCGW 09T302-S01020-SL-1	0.2	0.03-0.3	0.05-0.5	●	●	●
	CCGW 09T304-S01020-SL-1	0.4	0.03-0.3	0.05-0.5	●	●	●
	CCGW 09T308-S01020-SL-1	0.8	0.03-0.3	0.05-0.5	●	●	●
	CCGW 120402-S01020-SL-1	0.2	0.03-0.3	0.05-0.5	●	●	●
	CCGW 120404-S01020-SL-1	0.4	0.03-0.3	0.05-0.5	●	●	●
	CCGW 120408-S01020-SL-1	0.8	0.03-0.3	0.05-0.5	●	●	●
	CCGW 120412-S01020-SL-1	1.2	0.03-0.3	0.05-0.5	●	●	●
	CCGW 060202-S01020-SL-2	0.2	0.03-0.3	0.05-0.5	●	●	●
	CCGW 060204-S01020-SL-2	0.4	0.03-0.3	0.05-0.5	●	●	●
	CCGW 060208-S01020-SL-2	0.8	0.03-0.3	0.05-0.5	●	●	●
	CCGW 09T302-S01020-SL-2	0.2	0.03-0.3	0.05-0.5	●	●	●
	CCGW 09T304-S01020-SL-2	0.4	0.03-0.3	0.05-0.5	●	●	●
	CCGW 09T308-S01020-SL-2	0.8	0.03-0.3	0.05-0.5	●	●	●
	CCGW 120402-S01020-SL-2	0.2	0.03-0.3	0.05-0.5	●	●	●
	CCGW 120404-S01020-SL-2	0.4	0.03-0.3	0.05-0.5	●	●	●
	CCGW 120408-S01020-SL-2	0.8	0.03-0.3	0.05-0.5	●	●	●
	CCGW 120412-S01020-SL-2	1.2	0.03-0.3	0.05-0.5	●	●	●

Marked : ● Stock available ○ Non-stocked standard

Positive 55° (DC)

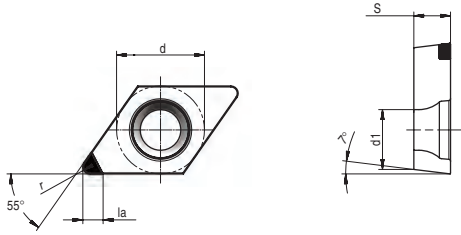

Dimensions (mm)				
Type	d	s	la	d1
DC_0702_	6.35	2.38	2.2	2.8
DC_11T3_	9.52	3.97	2.2	4.4

Inserts	Type	r (mm)	Recommended parameters		Grade		
			f (mm/rev)	ap (mm)	PB30	PB60	PB90
	DCGW 070202-S01020-SL-1	0.2	0.03-0.3	0.05-0.5	●	●	●
	DCGW 070204-S01020-SL-1	0.4	0.03-0.3	0.05-0.5	●	●	●
	DCGW 070208-S01020-SL-1	0.8	0.03-0.3	0.05-0.5	●	●	●
	DCGW 11T302-S01020-SL-1	0.2	0.03-0.3	0.05-0.5	●	●	●
	DCGW 11T304-S01020-SL-1	0.4	0.03-0.3	0.05-0.5	●	●	●
	DCGW 11T308-S01020-SL-1	0.8	0.03-0.3	0.05-0.5	●	●	●
	DCGW 11T312-S01020-SL-1	1.2	0.03-0.3	0.05-0.5	●	●	●
	DCGW 070202-S01020-SL-2	0.2	0.03-0.3	0.05-0.5	●	●	●
	DCGW 070204-S01020-SL-2	0.4	0.03-0.3	0.05-0.5	●	●	●
	DCGW 070208-S01020-SL-2	0.8	0.03-0.3	0.05-0.5	●	●	●
	DCGW 11T302-S01020-SL-2	0.2	0.03-0.3	0.05-0.5	●	●	●
	DCGW 11T304-S01020-SL-2	0.4	0.03-0.3	0.05-0.5	●	●	●
	DCGW 11T308-S01020-SL-2	0.8	0.03-0.3	0.05-0.5	●	●	●
	DCGW 11T312-S01020-SL-2	1.2	0.03-0.3	0.05-0.5	●	●	●

Marked : ● Stock available ○ Non-stocked standard

Positive 60° (TP)

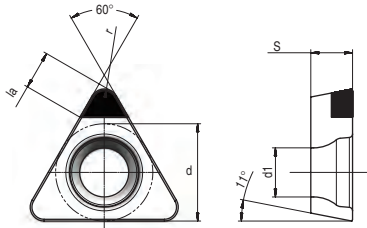

Dimensions (mm)				
Type	d	s	la	d1
TP_0802_	4.76	2.38	2.2	2.4
TP_0902_	5.56	2.38	2.2	2.8
TP_1103_	6.35	3.18	2.2	3.3
TP_1604_	9.52	4.76	2.2	4.4

Inserts	Type	r (mm)	Recommended parameters		Grade		
			f (mm/rev)	ap (mm)	PB30	PB60	PB90
	TPGW 080202-S01020-SL-1	0.2	0.03-0.3	0.05-0.5	●	●	●
	TPGW 080204-S01020-SL-1	0.4	0.03-0.3	0.05-0.5	●	●	●
	TPGW 090202-S01020-SL-1	0.2	0.03-0.3	0.05-0.5	●	●	●
	TPGW 090204-S01020-SL-1	0.4	0.03-0.3	0.05-0.5	●	●	●
	TPGW 090208-S01020-SL-1	0.8	0.03-0.3	0.05-0.5	●	●	●
	TPGW 110302-S01020-SL-1	0.2	0.03-0.3	0.05-0.5	●	●	●
	TPGW 110304-S01020-SL-1	0.4	0.03-0.3	0.05-0.5	●	●	●
	TPGW 160402-S01020-SL-1	0.2	0.03-0.3	0.05-0.5	●	●	●
	TPGW 160404-S01020-SL-1	0.4	0.03-0.3	0.05-0.5	●	●	●
	TPGW 160408-S01020-SL-1	0.8	0.03-0.3	0.05-0.5	●	●	●
	TPGW 080202-S01020-SL-3	0.2	0.03-0.3	0.05-0.5	●	●	●
	TPGW 080204-S01020-SL-3	0.4	0.03-0.3	0.05-0.5	●	●	●
	TPGW 090202-S01020-SL-3	0.2	0.03-0.3	0.05-0.5	●	●	●
	TPGW 090204-S01020-SL-3	0.4	0.03-0.3	0.05-0.5	●	●	●
	TPGW 090208-S01020-SL-3	0.8	0.03-0.3	0.05-0.5	●	●	●
	TPGW 110302-S01020-SL-3	0.2	0.03-0.3	0.05-0.5	●	●	●
	TPGW 110304-S01020-SL-3	0.4	0.03-0.3	0.05-0.5	●	●	●
	TPGW 160402-S01020-SL-3	0.2	0.03-0.3	0.05-0.5	●	●	●
	TPGW 160404-S01020-SL-3	0.4	0.03-0.3	0.05-0.5	●	●	●
	TPGW 160408-S01020-SL-3	0.8	0.03-0.3	0.05-0.5	●	●	●

Positive 35° (V)

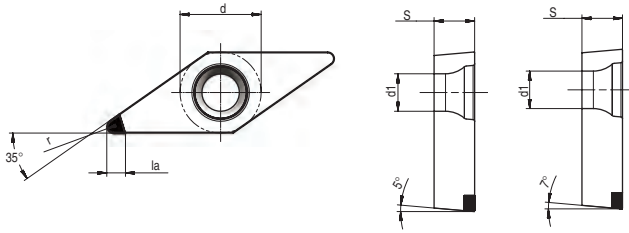

Dimensions (mm)				
Type	d	s	la	d1
VB_1103_	6.35	3.18	2.2	2.8
VC_1103_	6.35	3.18	2.2	2.8
VB_1604_	9.52	4.76	2.2	4.4
VC_1604_	9.52	4.76	2.2	4.4



Inserts	Type	r (mm)	Recommended parameters		Grade		
			f (mm/rev)	ap (mm)	PB30	PB60	PB90
	VBGW 110302-S01020-SL-1	0.2	0.03-0.3	0.05-0.5	●	●	●
	VBGW 110304-S01020-SL-1	0.4	0.03-0.3	0.05-0.5	●	●	●
	VBGW 110308-S01020-SL-1	0.8	0.03-0.3	0.05-0.5	●	●	●
	VBGW 160402-S01020-SL-1	0.2	0.03-0.3	0.05-0.5	●	●	●
	VBGW 160404-S01020-SL-1	0.4	0.03-0.3	0.05-0.5	●	●	●
	VBGW 160408-S01020-SL-1	0.8	0.03-0.3	0.05-0.5	●	●	●
	VBGW 110302-S01020-SL-2	0.2	0.03-0.3	0.05-0.5	●	●	●
	VBGW 110304-S01020-SL-2	0.4	0.03-0.3	0.05-0.5	●	●	●
	VBGW 110308-S01020-SL-2	0.8	0.03-0.3	0.05-0.5	●	●	●
	VBGW 160402-S01020-SL-2	0.2	0.03-0.3	0.05-0.5	●	●	●
	VBGW 160404-S01020-SL-2	0.4	0.03-0.3	0.05-0.5	●	●	●
	VBGW 160408-S01020-SL-2	0.8	0.03-0.3	0.05-0.5	●	●	●
	VCGW 110302-S01020-SL-1	0.2	0.03-0.3	0.05-0.5	●	●	●
	VCGW 110304-S01020-SL-1	0.4	0.03-0.3	0.05-0.5	●	●	●
	VCGW 110308-S01020-SL-1	0.8	0.03-0.3	0.05-0.5	●	●	●
	VCGW 160402-S01020-SL-1	0.2	0.03-0.3	0.05-0.5	●	●	●
	VCGW 160404-S01020-SL-1	0.4	0.03-0.3	0.05-0.5	●	●	●
	VCGW 160408-S01020-SL-1	0.8	0.03-0.3	0.05-0.5	●	●	●
	VCGW 110302-S01020-SL-2	0.2	0.03-0.3	0.05-0.5	●	●	●
	VCGW 110304-S01020-SL-2	0.4	0.03-0.3	0.05-0.5	●	●	●
	VCGW 110308-S01020-SL-2	0.8	0.03-0.3	0.05-0.5	●	●	●
	VCGW 160402-S01020-SL-2	0.2	0.03-0.3	0.05-0.5	●	●	●
	VCGW 160404-S01020-SL-2	0.4	0.03-0.3	0.05-0.5	●	●	●
	VCGW 160408-S01020-SL-2	0.8	0.03-0.3	0.05-0.5	●	●	●

Marked : ● Stock available ○ Non-stocked standard

Turning inserts

PCD Insert Denomination System

CCGW 09T304	-	2	-	NL	-	5	-	CB	PD20
1		2		3		4		5	6

<p>1-Standard ISO denomination system</p>	<p>2-Number of cutting edge</p> <p>1-One cutting edge 2-Two cutting edges 3-Three cutting edges</p>	<p>3-PCD insert structure</p> <p>NL--Standard structure with tipped PCD </p> <p>LL-- Full edge tipped PCD </p>	<p>4-Rake angle</p> <p>00---0° 05---5° 10---10°</p>
<p>5-Cutting edge preparation</p> <p>CB-- With chip breaker WG--With wiper edge "- " Without chip breaker</p>	<p>6-Grade</p> <p>PD01--Fine grain PCD PD10--Medium grain PCD PD20--Coarse grain PCD</p>		

PCD Insert Grade Introduction

Grade	Feature	Application
PD20	Universal grade, balanced wear resistance and toughness	1st choice for general machining of aluminum alloys

PCD Recommended Cutting Parameter

Grade	Material	Cutting speed Vc(m/min)	Feed f(mm/rev)	Cutting depth ap(mm)	Recommended application
PD20	Low-Si Aluminium Alloy (Si < 6%)	300-4000	0.03-0.2	0.05-0.5	Continuous/interrupt

Grade Application Guide

PCD insert applications				
Material Group	Materials	ISO	Uncoated	ISO
			PD20	
P	unalloy steels / Alloyed steels	P01		P01
		P05		P05
		P10		P10
		P15		P15
		P20		P20
		P25		P25
		P30		P30
		P35		P35
		P40		P40
		P45		P45
		P50		P50
		M	Stainless steels	M01
M05				M05
M10				M10
M15				M15
M20				M20
M25				M25
M30				M30
M35				M35
M40				M40
M45				M45
K	Cast iron	K01		K01
		K05		K05
		K10		K10
		K15		K15
		K20		K20
		K25		K25
		K30		K30
		K35		K35
		K40		K40
		K45		K45
		K50		K50
N	Aluminum/ Aluminum alloys	N01		N01
		N05		N05
		N10	PD20	N10
		N15		N15
		N20		N20
		N25		N25
N30	N30			
S	Heat resistant alloys	S01		S01
		S05		S05
		S10		S10
		S15		S15
		S20		S20
		S25		S25
		S30		S30
		S35		S35
		S40		S40
		H	Hardened steels/ Chilled cast iron	H01
H05				H05
H10				H10
H15				H15
H20				H20
H25				H25
H30		H30		

Turning inserts

Negative 80° (CN)

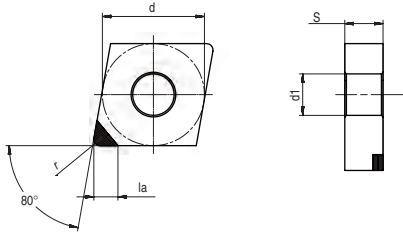

Dimensions (mm)				
Type	d	s	la	d1
CN_1204_	12.7	4.76	3.0	5.16

Inserts	Type	r (mm)	Recommended parameters		Grade
			f (mm/rev)	ap (mm)	
	CNGA 120402-1-NL-00	0.2	0.03-0.2	0.05-0.5	●
	CNGA 120404-1-NL-00	0.4	0.03-0.2	0.05-0.5	●
	CNGA 120408-1-NL-00	0.8	0.03-0.2	0.05-0.5	●
	CNGA 120402-2-NL-00	0.2	0.03-0.2	0.05-0.5	●
	CNGA 120404-2-NL-00	0.4	0.03-0.2	0.05-0.5	●
	CNGA 120408-2-NL-00	0.8	0.03-0.2	0.05-0.5	●

Positive 80° (CC)

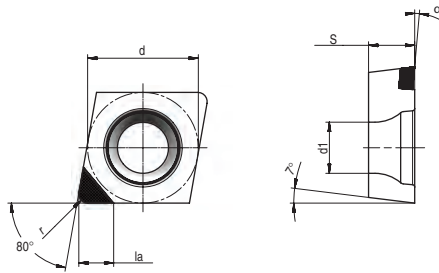

Dimensions (mm)				
Type	d	s	la	d1
CC_0602_	6.35	2.38	3.0	2.8
CC_09T3_	9.52	3.97	3.0	4.4
CC_1204_	12.7	4.76	3.0	5.5

Inserts	Type	r (mm)	α (°)	Recommended parameters		Grade
				f (mm/rev)	ap (mm)	PD20
	CCGW 060202-1-NL-05	0.2	5°	0.03-0.2	0.05-0.5	●
	CCGW 060204-1-NL-05	0.4	5°	0.03-0.2	0.05-0.5	●
	CCGW 060208-1-NL-05	0.8	5°	0.03-0.2	0.05-0.5	●
	CCGW 09T302-1-NL-05	0.2	5°	0.03-0.2	0.05-0.5	●
	CCGW 09T304-1-NL-05	0.4	5°	0.03-0.2	0.05-0.5	●
	CCGW 09T308-1-NL-05	0.8	5°	0.03-0.2	0.05-0.5	●
	CCGW 120402-1-NL-05	0.2	5°	0.03-0.2	0.05-0.5	●
	CCGW 120404-1-NL-05	0.4	5°	0.03-0.2	0.05-0.5	●
	CCGW 120408-1-NL-05	0.8	5°	0.03-0.2	0.05-0.5	●
	CCGW 060202 -2-NL-05	0.2	5°	0.03-0.2	0.05-0.5	●
	CCGW 060204 -2-NL-05	0.4	5°	0.03-0.2	0.05-0.5	●
	CCGW 060208 -2-NL-05	0.8	5°	0.03-0.2	0.05-0.5	●
	CCGW 09T302 -2-NL-05	0.2	5°	0.03-0.2	0.05-0.5	●
	CCGW 09T304 -2-NL-05	0.4	5°	0.03-0.2	0.05-0.5	●
	CCGW 09T308 -2-NL-05	0.8	5°	0.03-0.2	0.05-0.5	●
	CCGW 120402 -2-NL-05	0.2	5°	0.03-0.2	0.05-0.5	●
	CCGW 120404 -2-NL-05	0.4	5°	0.03-0.2	0.05-0.5	●
	CCGW 120408 -2-NL-05	0.8	5°	0.03-0.2	0.05-0.5	●

Positive 60° (T)

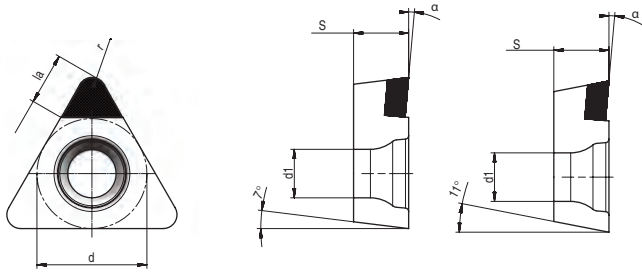

Dimensions (mm)				
Type	d	s	la	d1
TC_0802_	4.76	2.38	3.0	2.4
TC_1103_	6.35	3.18	3.0	2.8
TC_1604_	9.52	4.76	3.0	4.4
TP_0802_	4.76	2.38	3.0	2.4
TP_1604_	9.52	4.76	3.0	4.4

Inserts	Type	r (mm)	α (°)	Recommended parameters		Grade
				f (mm/rev)	ap (mm)	
	TCGW 080202-1-NL-05	0.2	5°	0.03-0.2	0.05-0.5	●
	TCGW 080204-1-NL-05	0.4	5°	0.03-0.2	0.05-0.5	●
	TCGW 080208-1-NL-05	0.8	5°	0.03-0.2	0.05-0.5	●
	TCGW 110202-1-NL-05	0.2	5°	0.03-0.2	0.05-0.5	●
	TCGW 110204-1-NL-05	0.4	5°	0.03-0.2	0.05-0.5	●
	TCGW 110302-1-NL-05	0.2	5°	0.03-0.2	0.05-0.5	●
	TCGW 110304-1-NL-05	0.4	5°	0.03-0.2	0.05-0.5	●
	TCGW 110308-1-NL-05	0.8	5°	0.03-0.2	0.05-0.5	●
	TCGW 160402-1-NL-05	0.2	5°	0.03-0.2	0.05-0.5	●
	TCGW 160404-1-NL-05	0.4	5°	0.03-0.2	0.05-0.5	●
	TCGW 160408-1-NL-05	0.8	5°	0.03-0.2	0.05-0.5	●
	TCGW 080202-3-NL-05	0.2	5°	0.03-0.2	0.05-0.5	●
	TCGW 080204-3-NL-05	0.4	5°	0.03-0.2	0.05-0.5	●
	TCGW 080208-3-NL-05	0.8	5°	0.03-0.2	0.05-0.5	●
	TCGW 110302-3-NL-05	0.2	5°	0.03-0.2	0.05-0.5	●
	TCGW 110304-3-NL-05	0.4	5°	0.03-0.2	0.05-0.5	●
	TCGW 110308-3-NL-05	0.8	5°	0.03-0.2	0.05-0.5	●
	TCGW 160302-3-NL-05	0.2	5°	0.03-0.2	0.05-0.5	●
	TCGW 160304-3-NL-05	0.4	5°	0.03-0.2	0.05-0.5	●
	TCGW 160308-3-NL-05	0.8	5°	0.03-0.2	0.05-0.5	●
	TPGW 080202-1-NL-05	0.2	5°	0.03-0.2	0.05-0.5	●
	TPGW 080204-1-NL-05	0.4	5°	0.03-0.2	0.05-0.5	●
	TPGW 080208-1-NL-05	0.8	5°	0.03-0.2	0.05-0.5	●
	TPGW 080202-1-NL-05	0.2	5°	0.03-0.2	0.05-0.5	●
	TPGW 080204-1-NL-05	0.4	5°	0.03-0.2	0.05-0.5	●
	TPGW 080204-1-NL-05	0.8	5°	0.03-0.2	0.05-0.5	●
	TPGW 110302-1-NL-05	0.2	5°	0.03-0.2	0.05-0.5	●
	TPGW 110304-1-NL-05	0.4	5°	0.03-0.2	0.05-0.5	●
	TPGW 080202-3-NL-05	0.2	5°	0.03-0.2	0.05-0.5	●
	TPGW 080204-3-NL-05	0.4	5°	0.03-0.2	0.05-0.5	●
	TPGW 080208-3-NL-05	0.8	5°	0.03-0.2	0.05-0.5	●
	TPGW 160402-3-NL-05	0.2	5°	0.03-0.2	0.05-0.5	●
	TPGW 160404-3-NL-05	0.4	5°	0.03-0.2	0.05-0.5	●
	TPGW 160408-3-NL-05	0.8	5°	0.03-0.2	0.05-0.5	●

ACHTECK

www.achtecktool.com



CUTTING TOOL CATALOGUE

Grooving holder	96
Grooving tool holder denomination	99
Overview of grooving tool holder	100
Grooving tool holder	103
Grooving insert	117
Grooving insert denomination	117
Overview of grooving insert	118
Grooving insert geometry introduction	120
Grade application guide	121
Grooving grade description	123
Grooving insert	124
Cutting parameter recommendation	134

ACHTECK

www.achtecktool.com

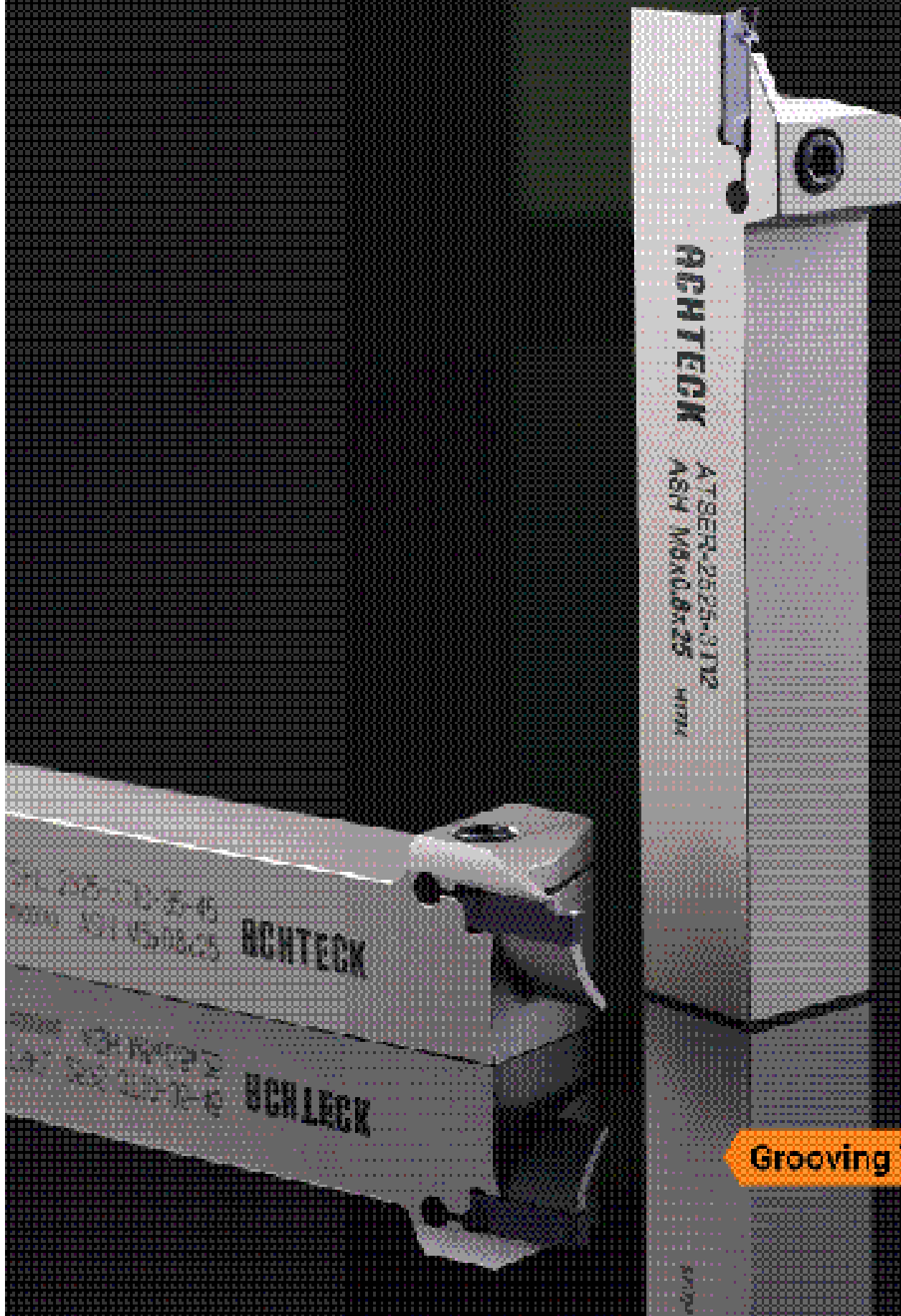

Grooving Tool Holder

Grooving Holder Denomination System

A	G	U	E	R	32	25	-	4	T25	-	40	-	80	-	SW
1	2	3	4	5	6	8	-	9	10	-	11	-	12	-	13
					7										

1-Company name
ACHTECK

2-Application	
G	Grooving
T	Turning

3- Shape of holder head
S: Straight-180°
U: Under cut-45°
P: Perpendicular-90°

4-Machining type
E: External
I: Internal
F: Facing

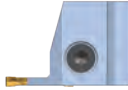
5-Hand of tool	
	L: Left hand
	R: Right hand

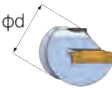
6-Holder diameter	
 ϕd	20=20mm 25=25mm 32=32mm

7-Holder height	
 h	20=20mm 25=25mm 32=32mm

8-Holder width	
 b	20=20mm 25=25mm 32=32mm

9-Insert width	
 W	2=2mm 3=3mm 4=4mm

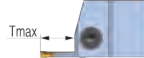
10-Ap
T25=Max 25mm
 T _{max}

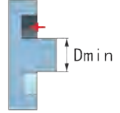

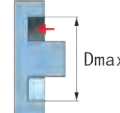



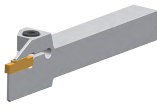

11-Minimum cutting diameter	
 D _{min}	40=40mm

12-Maximum cutting diameter	
 D _{max}	80=80mm

13-Special code
SW: For swiss machine OB: Outside bulge holders C: With internal coolant D: Reinforced holders

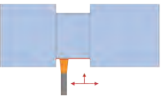
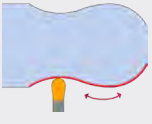

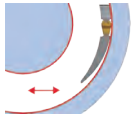







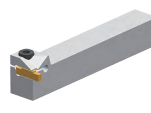

Grooving holders

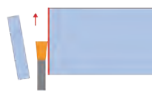
Overview of Grooving Holders

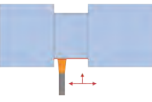
Application		Holder	External grooving			
			ATSER/L	ATSER/L-D	ATSER/L-SW	AGUER/L
						
Page		P103	P105	P106	P107	
External grooving	Parting off		●	●	●	
	Grooving		●	●	●	
	Turning		●	●	●	
	Profiling		●	●	●	
	Under cut					●
Face grooving	Grooving					
	Turning					
Internal machining	Grooving					
	Turning					

Marked : ● Best choice

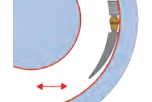







Overview of Grooving Holders

Application		Holder	Face grooving				
			ATSFR/L	ATSFR/L-OB	AGSFR/L	AGPFR/L	ATPFR/L
							
Page			P108	P109	P110	P111	P112
External grooving	Parting off						
	Grooving					●	●
	Turning					○	○
	Profiling						
	Under cut						
Face grooving	Grooving		●	●	●	●	●
	Turning		●	●	●	●	●
Internal machining	Grooving						
	Turning						

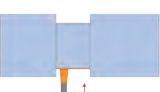
Marked : ● Best choice

Grooving holders

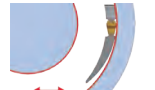
Overview of Grooving Holders

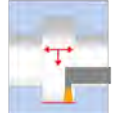
Application		Holder	Internal machining			
			ATPIR/L	ATSIR/L	AGSIR/L	AGUIR/L
		Page		P113	P114	P115
External grooving	Parting off					
	Grooving					
	Turning					
	Profiling					
	Under cut					●
Face grooving	Grooving			●	●	
	Turning			●	●	
Internal machining	Grooving		●			
	Turning		●			

Marked : ● Best choice

ATSER/L External Turning and Grooving Holder

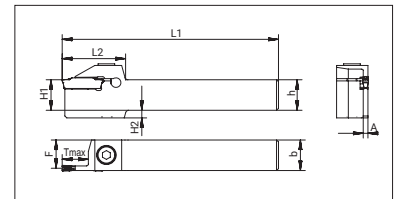
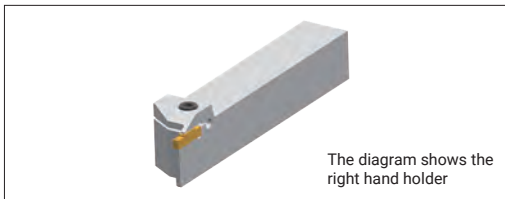



Product code		Dimension(mm)									Inserts*
		h	b	H1	H2	A	L1	L2	F	Tmax	
ATSER/L	1616-2T08	16	16	16	4	1.8	110	32	15.1	8	ACD/ACS/ATD
	1616-2T12	16	16	16	4	1.8	110	32	15.1	12	
	1616-2T17	16	16	16	4	1.8	110	38	15.1	17	
	2020-2T08	20	20	20	0	1.8	125	32	19.1	8	
	2020-2T12	20	20	20	0	1.8	125	32	19.1	12	
	2020-2T17	20	20	20	0	1.8	125	38	19.1	17	
	2525-2T08	25	25	25	0	1.8	150	32	24.1	8	
	2525-2T12	25	25	25	0	1.8	150	32	24.1	12	
2525-2T17	25	25	25	0	1.8	150	38	24.1	17		
ATSER/L	1616-3T09	16	16	16	4	2.4	110	32	14.8	9	
	1616-3T12	16	16	16	4	2.4	110	32	14.8	12	
	1616-3T20	16	16	16	4	2.4	110	38	14.8	20	
	2020-3T09	20	20	20	0	2.4	125	32	18.8	9	
	2020-3T12	20	20	20	0	2.4	125	32	18.8	12	
	2020-3T20	20	20	20	0	2.4	125	38	18.8	20	
	2525-3T09	25	25	25	0	2.4	150	32	23.8	9	
	2525-3T12	25	25	25	0	2.4	150	32	23.8	12	
2525-3T20	25	25	25	0	2.4	150	38	23.8	20		
2525-3T25	25	25	25	0	2.4	150	45	23.8	25		
ATSER/L	1616-4T10	16	16	16	4	3.0	110	32	14.5	10	
	1616-4T15	16	16	16	4	3.0	110	32	14.5	15	
	1616-4T25	16	16	16	4	3.0	110	45	14.5	25	
	2020-4T10	20	20	20	0	3.0	125	32	18.5	10	
	2020-4T15	20	20	20	0	3.0	125	32	18.5	15	
	2020-4T25	20	20	20	0	3.0	125	45	18.5	25	
	2525-4T10	25	25	25	0	3.0	150	32	23.5	10	
	2525-4T15	25	25	25	0	3.0	150	32	23.5	15	
2525-4T20	25	25	25	0	3	150	32	23.5	20		
2525-4T25	25	25	25	0	3.0	150	45	23.5	25		
ATSER/L	2020-5T12	20	20	20	0	4	125	38	18.1	12	
	2020-5T20	20	20	20	0	4	125	38	18.1	20	
	2525-5T12	25	25	25	0	4	150	38	23.1	12	
	2525-5T20	25	25	25	0	4	150	38	23.1	20	
	2525-5T32	25	25	25	0	4	150	55	23	32	
	3232-5T12	32	32	32	0	3.9	170	35.8	30.08	12	
	3232-5T20	32	32	32	0	3.9	170	37.8	30.08	20	
	3232-5T25	32	32	32	0	3.9	170	44.8	30.08	25	
3232-5T32	32	32	32	0	3.9	170	55	30.08	32		
ATSER/L	2020-6T12	20	20	20	0	5	125	38	17.6	12	
	2020-6T20	20	20	20	0	5	125	40	17.6	20	
	2525-6T12	25	25	25	7	5	150	38	22.6	12	
	2525-6T20	25	25	25	7	5	150	40	22.6	20	
	2525-6T32	25	25	25	7	5	150	55	22.5	32	
	3232-6T12	32	32	32	0	4.9	170	35.8	30.08	12	
	3232-6T20	32	32	32	0	4.9	170	39.8	30.08	20	
	3232-6T25	32	32	32	0	4.9	170	44.8	30.08	25	
3232-6T32	32	32	32	0	4.9	170	55	30.08	32		
ATSER/L	2525-8T16	25	25	25	7	5.9	150	45	22.1	16	
	2525-8T25	25	25	25	7	5.9	150	45	22.1	25	
	2525-8T36	25	25	25	7	5.9	150	60	22.1	36	
	3232-8T25	32	32	32	0	5.9	170	45	29.1	25	
	3232-8T36	32	32	32	0	5.9	170	60	29.1	36	

Inserts*: ACD/ACS series are only applicable to grooving and parting off machining

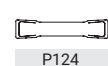
Grooving holders



Product code	Screw	Wrench
		
ATSER/L 1616-2/3	SH050160	LT-H4
ATSER/L 2020-2/3	SH050200	LT-H4
ATSER/L 2525-2/3	SH050250	LT-H4
ATSER/L 1616-4/5	SH060160	LT-H5
ATSER/L 2020-4/5	SH060200	LT-H5
ATSER/L 2525-4/5	SH060250	LT-H5
ATSER/L 2020-6	SH080200	LT-H6
ATSER/L 2525-6/8	SH080250	LT-H6
ATSER/L 3232-5	SH060250	LT-H5
ATSER/L 3232-6	SH080250	LT-H6
ATSER/L 3232-8	SH080250	LT-H6

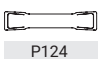

ATSER/L-D Reinforced External Turning and Grooving Holder

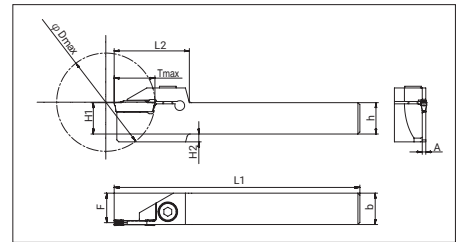
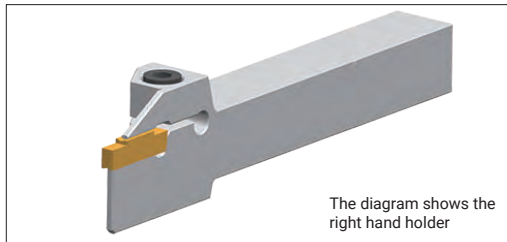
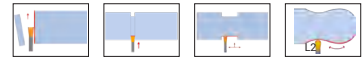

Product code		Dimension(mm)										Inserts*
		h	b	H1	H2	A	L1	L2	F	Tmax	Dmax	
ATSER/L	1010-2T15-D40	10	10	10	6	1.8	125	32	9.1	15	40	ACD/ACS/ ATD
	1212-2T15-D40	12	12	12	4	1.8	125	32	11.1	15	40	
	1616-2T20-D45	16	16	16	4	1.8	125	38	15.1	20	45	
	2020-2T20-D45	20	20	20	0	1.8	125	38	19.1	20	45	
	2525-2T20-D45	25	25	25	0	1.8	150	38	24.1	20	45	
	1212-3T15-D40	12	12	12	4	2.4	125	32	10.8	15	40	
	1616-3T20-D45	16	16	16	4	2.4	125	32	14.8	20	45	
	2020-3T20-D45	20	20	20	0	2.4	125	32	18.8	20	45	
	2525-3T20-D45	25	25	25	0	2.4	150	32	23.8	20	45	
2525-3T25-D60	25	25	25	7	2.4	150	45	23.8	25	60		

Inserts*: ACD/ACS series are only applicable to grooving and parting off machining

Product code	Screw	Wrench
ATSER/L 1010-2	SH050160	LT-H4
ATSER/L 1212-2/3	SH050160	LT-H4
ATSER/L 1616-2	SH050160	LT-H4
ATSER/L 1616-3	SH050200	LT-H4
ATSER/L 2020-2/3	SH050200	LT-H4
ATSER/L 2525-2/3	SH050250	LT-H4

The max. cutting depth vs workpiece diameter.

Product code		Workpiece diameter	Tmax																
			≤8	9	10	11	12	13	14	15	17	18	19	20	21	22	23	24	25
ATSER/L	1010-2T15-D40	Dmax	∞	∞	∞	269	120	79	59	40	-	-	-	-	-	-	-	-	-
	1212-2T15-D40		∞	∞	∞	269	120	79	59	40	-	-	-	-	-	-	-	-	-
	1616-2T20-D45		∞	∞	∞	∞	∞	432	193	125	76	64	57	45	-	-	-	-	-
	2020-2T20-D45		∞	∞	∞	∞	∞	432	193	125	76	64	57	45	-	-	-	-	-
	2525-2T20-D45		∞	1468	339	193	136	106	87	75	60	56	52	45	-	-	-	-	-
	1212-3T15-D40		∞	∞	∞	269	120	79	59	40	-	-	-	-	-	-	-	-	-
	1616-3T20-D45		∞	∞	∞	∞	∞	432	193	125	76	64	57	45	-	-	-	-	-
	2020-3T20-D45		∞	∞	∞	∞	∞	432	193	125	76	64	57	45	-	-	-	-	-
	2525-3T20-D45		∞	1468	339	193	136	106	87	75	60	56	52	45	-	-	-	-	-
	2525-3T25-D60		∞	∞	∞	∞	∞	∞	∞	∞	418	237	167	130	107	91	81	73	60

The diameter is infinite



ATSER/L-SW External Turning and Grooving Holder for Swiss Lathe

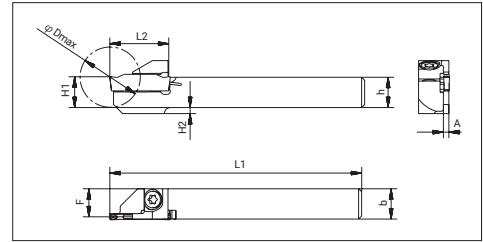
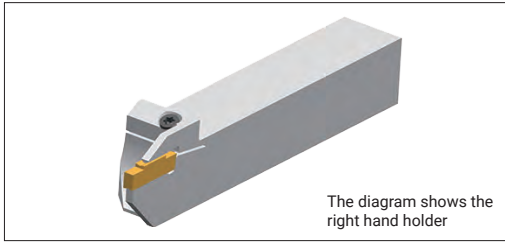
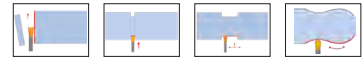

Product code		Dimension(mm)									Inserts*
		h	b	H1	H2	A	L1	L2	F	Dmax	
ATSER/L	1010-2D20-SW	10	10	10	2	1.8	125	20	9.1	20	ACD/ACS/ ATD
	1212-2D24-SW	12	12	12	2	1.8	125	20	11.1	24	
	1414-2D24-SW	14	14	14	0	1.8	125	20	13.1	24	
	1616-2D32-SW	16	16	16	0	1.8	125	25	15.1	32	
	1212-3D24-SW	12	12	12	2	2.4	125	20	10.8	24	
	1616-3D32-SW	16	16	16	0	2.4	125	25	14.8	32	
	1616-3D38-SW	16	16	16	0	2.4	125	27	14.8	38	
	2020-3D45-SW	20	20	20	0	2.4	125	24	18.8	45	

Inserts*: ACD/ACS series are only applicable to grooving and parting off machining

Product code	Screw	Wrench
	ATSER/L-SW	 SP040125



AGUER/L External Under Cut Holder

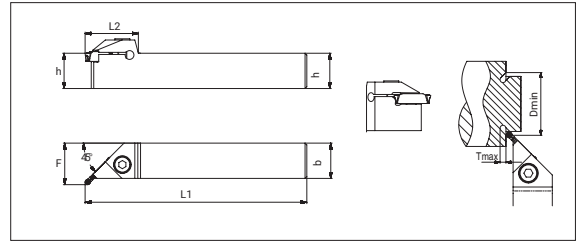
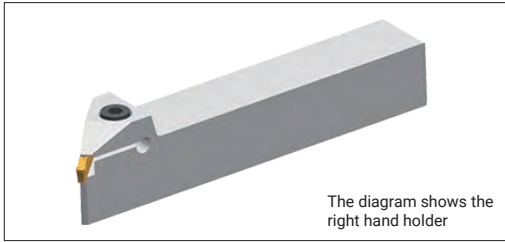

Product code		Insert Dimension (mm)	Dimension(mm)								Inserts*
			h	b	H1	L1	L2	F	Tmax	Dmin	
AGUER/L	1616-3	2,3	16	16	16	110	29.5	18.8	3	60	ATD
	1616-4	4	16	16	16	110	29.5	18.8	3	55	
	2020-3	2,3	20	20	20	125	29.5	22.8	3	60	
	2020-4	4	20	20	20	125	29.5	22.8	3	55	
	2525-3	2,3	25	25	25	150	29.5	27.8	3	60	
	2525-4	4	25	25	25	150	29.5	27.8	3	55	
	2525-6	5,6	25	25	25	150	32.5	28.0	3.5	55	

Product code	Screw	Wrench
AGUER/L 1616-3	SH050160	LT-H4
AGUER/L 2020-3	SH050200	LT-H4
AGUER/L 2525-3	SH050250	LT-H4
AGUER/L 1616-4	SH060160	LT-H5
AGUER/L 2020-4	SH060200	LT-H5
AGUER/L 2525-4	SH060250	LT-H5
AGUER/L 2525-6	SH060250	LT-H5

Grooving holders



ATSFR/L Face Grooving and Turning Holder

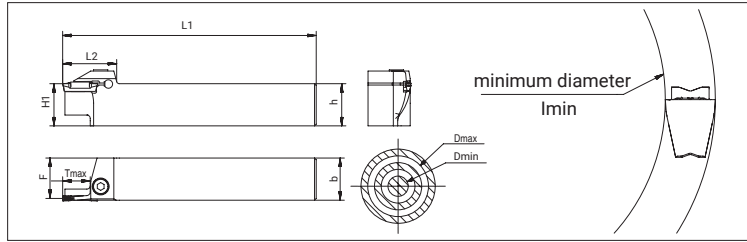
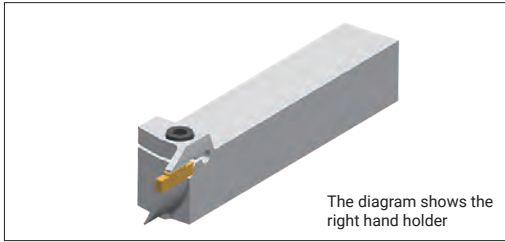
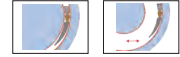

Product code	Dimension(mm)									Inserts size (mm)	Minimum machining diameter of face grooving inserts Imin(mm)							Inserts*	
	h	b	H1	L1	L2	F	Tmax	Dmin	Dmax		TS	TM	Ground	RM	CS	CM	CH		
ATSFR/L	2525-3T10-35-45	25	25	25	150	32	23.95	10	35	45	3	24	24	-	-	-	-	-	ACD/ACS/ATD
	2525-3T10-40-55	25	25	25	150	32	23.95	10	40	55	3	24	24	-	-	-	-	-	
	2525-3T15-45-65	25	25	25	150	32	23.95	15	45	65	3	24	24	59	59	-	-	-	
	2525-3T15-55-85	25	25	25	150	32	23.95	15	55	85	3	24	24	59	59	79	79	79	
	2525-4T15-35-50	25	25	25	150	32	23.55	15	35	50	4	22	22	42	42	-	42	42	
	2525-4T15-45-65	25	25	25	150	32	23.55	15	45	65	4	22	22	42	42	-	42	42	
	2525-4T15-55-85	25	25	25	150	32	23.55	15	55	85	4	22	22	42	42	-	42	42	
	2525-5T20-50-80	25	25	25	150	40	23.05	20	50	80	5	20	20	40	40	-	50	50	
	2525-5T20-70-110	25	25	25	150	40	23.05	20	70	110	5	20	20	40	40	-	50	50	
	2525-5T20-100-150	25	25	25	150	40	23.05	20	100	150	5	20	20	40	40	-	50	50	
	2525-5T20-140-200	25	25	25	150	40	23.05	20	140	200	5	20	20	40	40	-	50	50	
	2525-6T20-50-85	25	25	25	150	40	22.55	20	50	85	6	18	18	38	38	-	48	48	
	2525-6T20-75-150	25	25	25	150	40	22.55	20	75	150	6	18	18	38	38	-	48	48	
2525-6T20-140-250	25	25	25	150	40	22.55	20	140	250	6	18	18	38	38	-	48	48		
2525-6T20-200-000	25	25	25	150	40	22.55	20	200	∞	6	18	18	38	38	-	48	48		

- 1.Inserts*: ACD/ACS series are only applicable to grooving machining
- 2."-"Indicates that the insert is not a choice
- 3.Having selected the range of tool holder, please check the minimum face grooving machining diameter of the selected insert

Product code	Screw	Wrench
ATSFR/L 2525-3	SH050250	LT-H4
ATSFR/L 2525-4	SH060250	LT-H5
ATSFR/L 2525-5	SH080250	LT-H6
ATSFR/L 2525-6	SH080250	LT-H6

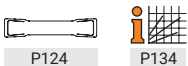

ATSFR/L-OB Face Grooving and Turning Holder (Outside Bluge Type)

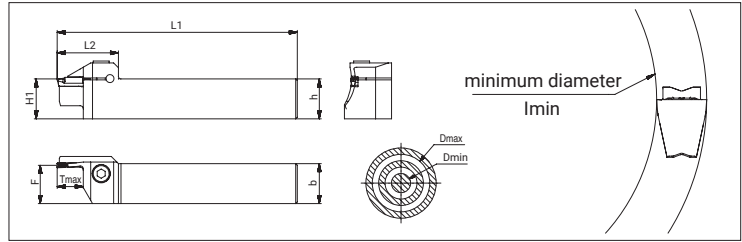
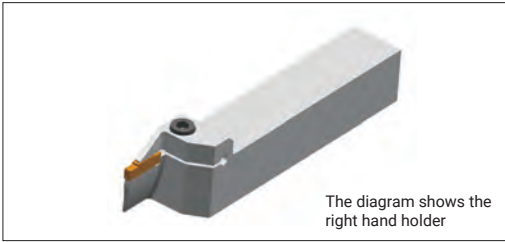
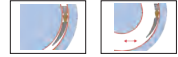

Product code	Dimension(mm)										Minimum machining diameter of face grooving inserts Imin(mm)							Inserts*
	h	b	H1	L1	L2	F	Tmax	Dmin	Dmax	TS	TM	Ground	RM	CS	CM	CH		
ATSFR/L	2020-3T10-30-40-OB	20	20	20	140	31	18.95	10	30	40	24	24	-	-	-	-	-	
	2020-3T10-35-50-OB	20	20	20	140	31	18.95	10	35	50	24	24	-	-	-	-	-	
	2020-3T15-45-70-OB	20	20	20	140	35	18.95	15	45	70	24	24	59	59	-	-	-	
	2020-3T15-65-100-OB	20	20	20	140	35	18.95	15	65	100	24	24	59	59	79	79	79	
	2020-4T10-20-30-OB	20	20	20	140	31	18.55	10	20	30	22	22	-	-	-	-	-	
	2020-4T10-25-35-OB	20	20	20	140	31	18.55	10	25	35	22	22	-	-	-	-	-	
	2020-4T16-30-45-OB	20	20	20	140	36	18.55	16	30	45	22	22	-	-	-	-	-	
	2020-4T16-35-50-OB	20	20	20	140	36	18.55	16	35	50	22	22	42	42	-	42	42	
	2020-4T16-45-70-OB	20	20	20	140	36	18.55	16	45	70	22	22	42	42	-	42	42	
	2020-4T16-65-120-OB	20	20	20	140	36	18.55	16	65	120	22	22	42	42	-	42	42	
	2020-4T16-115-200-OB	20	20	20	140	36	18.55	16	115	200	22	22	42	42	-	42	42	
	2525-3T10-35-50-OB	25	25	25	150	38	23.95	10	35	50	24	24	-	-	-	-	-	
	2525-3T15-45-70-OB	25	25	25	150	38	23.95	15	45	70	24	24	59	59	-	-	-	
	2525-3T15-65-100-OB	25	25	25	150	38	23.95	15	65	100	24	24	59	59	79	79	79	
	2525-4T10-25-35-OB	25	25	25	150	39	23.55	10	25	35	22	22	-	-	-	-	-	
	2525-4T20-30-45-OB	25	25	25	150	39	23.55	20	30	45	22	22	-	-	-	-	-	
	2525-4T20-35-50-OB	25	25	25	150	39	23.55	20	35	50	22	22	42	42	-	42	42	
	2525-4T20-45-70-OB	25	25	25	150	39	23.55	20	45	70	22	22	42	42	-	42	42	
	2525-4T20-65-125-OB	25	25	25	150	39	23.55	20	65	125	22	22	42	42	-	42	42	
	2525-4T20-115-200-OB	25	25	25	150	39	23.55	20	115	200	22	22	42	42	-	42	42	
	2525-4T20-190-000-OB	25	25	25	150	39	23.55	20	190	∞	22	22	42	42	-	42	42	
	2525-5T25-50-80-OB	25	25	25	150	49	23.05	25	50	80	20	20	40	40	-	50	50	
	2525-5T15-50-80-OB	25	25	25	150	41	23.05	15	50	80	20	20	40	40	-	50	50	
	2525-5T25-70-110-OB	25	25	25	150	49	23.05	25	70	110	20	20	40	40	-	50	50	
	2525-5T15-70-110-OB	25	25	25	150	49	23.05	15	70	110	20	20	40	40	-	50	50	
	2525-5T25-100-150-OB	25	25	25	150	49	23.05	25	100	150	20	20	40	40	-	50	50	
	2525-5T25-140-200-OB	25	25	25	150	49	23.05	25	140	200	20	20	40	40	-	50	50	
	2525-5T25-190-000-OB	25	25	25	150	49	23.05	25	190	∞	20	20	40	40	-	50	50	
	2525-6T25-50-70-OB	25	25	25	150	49	22.55	25	50	70	18	18	38	38	-	48	48	
	2525-6T25-60-100-OB	25	25	25	150	49	22.55	25	60	100	18	18	38	38	-	48	48	
2525-6T25-90-180-OB	25	25	25	150	49	22.55	25	90	180	18	18	38	38	-	48	48		
2525-6T25-170-400-OB	25	25	25	150	49	22.55	25	170	400	18	18	38	38	-	48	48		
2525-6T25-390-000-OB	25	25	25	150	49	22.55	25	390	∞	18	18	38	38	-	48	48		

1. Inserts*: ACD/ACS series are only applicable to grooving machining
2. "-" Indicates that the insert is not a choice
3. Having selected the range of tool holder, please check the minimum face grooving machining diameter of the selected insert

Product code	Screw	Wrench
ATSFR/L-OB 2020-3/4	SH060200	LT-H5
ATSFR/L-OB 2525-3	SH060250	LT-H5
ATSFR/L-OB 2525-4	SH060250	LT-H5
ATSFR/L-OB 2525-5	SH080250	LT-H6
ATSFR/L-OB 2525-6	SH080250	LT-H6



AGSFR/L External & Face Grooving and Turning Holder

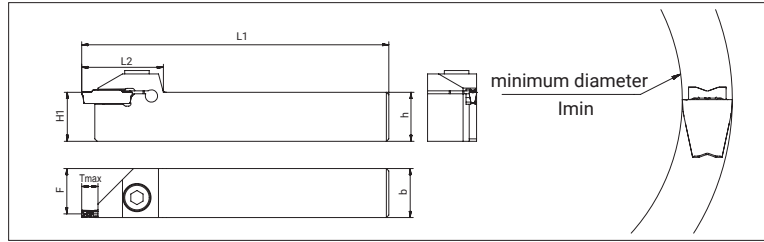
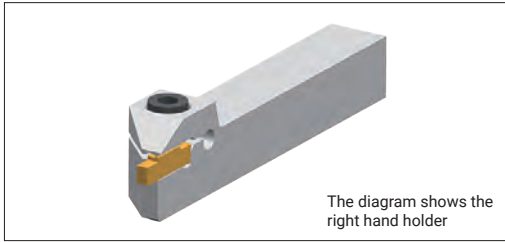
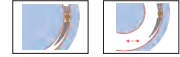

Product code	Inserts size (mm)	Dimension(mm)								Minimum machining diameter of face grooving inserts lmin(mm)							Inserts*
		h	b	H1	L1	L2	F	Tmax	TS	TM	Ground	RM	CS	CM	CH		
AGSFR/L	1616-4	2	16	16	16	110	32	14.55	4.6	196	-	100	196	196	196	196	ACD/ACS/ ATD
		3	16	16	16	110	32	14.55	4.6	24	24	59	59	79	79		
		4	16	16	16	110	32	14.55	4.6	22	22	42	42	-	42	42	
	2020-4	2	20	20	20	125	32	18.55	4.6	196	-	100	196	196	196	196	
		3	20	20	20	125	32	18.55	4.6	24	24	59	59	79	79	79	
		4	20	20	20	125	32	18.55	4.6	22	22	42	42	-	42	42	
	2020-6	5	20	20	20	125	38	17.58	4.6	20	20	40	40	-	50	50	
		6	20	20	20	125	38	17.58	4.6	18	18	38	38	-	48	48	
	2525-4	2	25	25	25	150	38	23.55	4.6	196	-	100	196	196	196	196	
		3	25	25	25	150	38	23.55	4.6	24	24	59	59	79	79	79	
		4	25	25	25	150	38	23.55	4.6	22	22	42	42	-	42	42	
	2525-6	5	25	25	25	150	38	22.58	4.6	20	20	40	40	-	50	50	
		6	25	25	25	150	38	22.58	4.6	18	18	38	38	-	48	48	

- 1.Inserts*: ACD/ACS series are only applicable to grooving machining
- 2."-"Indicates that the insert is not a choice
- 3.Having selected the range of tool holder, please check the minimum face grooving machining diameter of the selected insert

Product code	Screw	Wrench
AGSFR/L 1616	SH060160	LT-H5
AGSFR/L 2020	SH060200	LT-H5
AGSFR/L 2525	SH060250	LT-H5

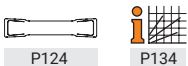

AGPFR/L Face Grooving and Turning Holder

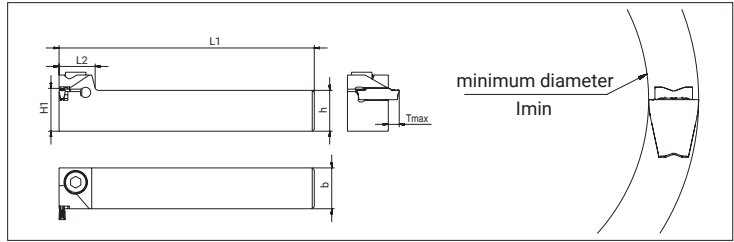
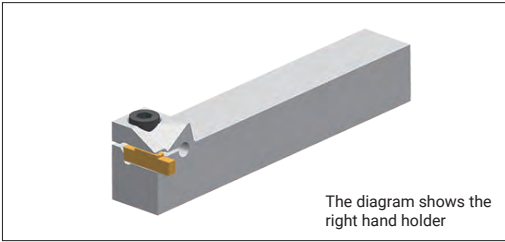
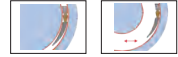

Product code		Inserts size (mm)	Dimension(mm)						Minimum machining diameter of face grooving inserts Imin(mm)							Inserts*
			h	b	H1	L1	L2	Tmax	TS	TM	Ground	RM	CS	CM	CH	
AGPFR/L	2020-4	2	20	20	20	125	20	4.6	196	-	100	196	196	196	196	ACD/ACS/ATD
		3	20	20	20	125	20	4.6	24	24	59	59	79	79	79	
		4	20	20	20	125	20	4.6	22	22	42	42	-	42	42	
	2525-4	2	25	25	25	150	20	4.6	196	-	100	196	196	196	196	
		3	25	25	25	150	20	4.6	24	24	59	59	79	79	79	
		4	25	25	25	150	20	4.6	22	22	42	42	-	42	42	
	2525-6	5	25	25	25	150	25	4.6	20	20	40	40	-	50	50	
		6	25	25	25	150	25	4.6	18	18	38	38	-	48	48	

- 1.Inserts*: ACD/ACS series are only applicable to grooving machining
- 2."-"Indicates that the insert is not a choice
- 3.Having selected the range of tool holder, please check the minimum face grooving machining diameter of the selected insert

Product code	Screw	Wrench
	AGPFR/L 2020	SH060200
AGPFR/L 2525	SH060250	LT-H5



ATPFR/L Face Grooving and Turning Holder

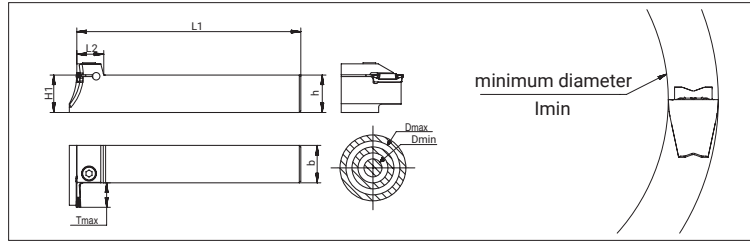
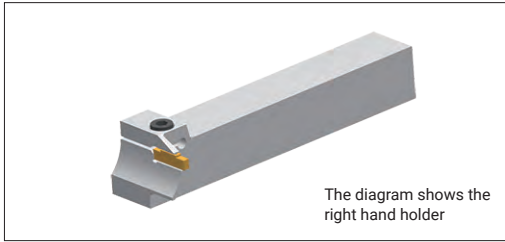
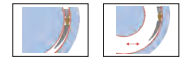

Product code	Inserts block size (mm)	Dimension(mm)							Minimum machining diameter of face grooving inserts lmin(mm)							Inserts*
		h	b	L1	L2	Tmax	Dmin	Dmax	TS	TM	Ground	RM	CS	CM	CH	
ATPFR/L 2525-3T10-30-40	3	25	25	150	18	10	30	40	24	24	-	-	-	-	-	ACD/ ACS/ ATD
ATPFR/L 2525-3T10-35-50	3	25	25	150	18	10	35	50	24	24	-	-	-	-	-	
ATPFR/L 2525-3T15-45-60	3	25	25	150	18	15	45	60	24	24	-	-	-	-	-	
ATPFR/L 2525-3T15-55-85	3	25	25	150	18	15	55	85	24	24	59	59	79	79	79	
ATPFR/L 2525-4T12-25-40	4	25	25	150	18.5	12	25	40	22	22	-	-	-	-	-	
ATPFR/L 2525-4T15-35-50	4	25	25	150	18.5	15	35	50	22	22	42	42	-	42	42	
ATPFR/L 2525-4T15-45-60	4	25	25	150	18.5	15	45	60	22	22	42	42	-	42	42	
ATPFR/L 2525-4T15-55-85	4	25	25	150	18.5	15	55	85	22	22	42	42	-	42	42	
ATPFR/L 2525-5T20-50-80	5	25	25	150	22	20	50	80	20	20	40	40	-	50	50	
ATPFR/L 2525-5T20-70-110	5	25	25	150	22	20	70	110	20	20	40	40	-	50	50	
ATPFR/L 2525-5T20-100-150	5	25	25	150	22	20	100	150	20	20	40	40	-	50	50	
ATPFR/L 2525-5T20-140-200	5	25	25	150	22	20	140	200	20	20	40	40	-	50	50	
ATPFR/L 2525-5T20-190-000	5	25	25	150	22	20	190	∞	20	20	40	40	-	50	50	
ATPFR/L 2525-6T20-50-85	6	25	25	150	22	20	50	85	18	18	38	38	-	48	48	
ATPFR/L 2525-6T20-75-150	6	25	25	150	22	20	75	150	18	18	38	38	-	48	48	
ATPFR/L 2525-6T20-140-250	6	25	25	150	22	20	140	250	18	18	38	38	-	48	48	
ATPFR/L 2525-6T20-240-000	6	25	25	150	22	20	240	∞	-	48	48	18	18	38	38	

- 1. Inserts*: ACD/ACS series are only applicable to grooving machining
- 2. "-" Indicates that the insert is not a choice
- 3. Having selected the range of tool holder, please check the minimum face grooving machining diameter of the selected insert

Product code	Screw	Wrench
ATPFR/L2525-3	SH050250	LT-H4
ATPFR/L2525-4	SH060250	LT-H5
ATPFR/L2525-5	SH080250	LT-H6
ATPFR/L2525-6	SH080250	LT-H6



ATPIR/L Internal Grooving, Turning and Profiling Holder

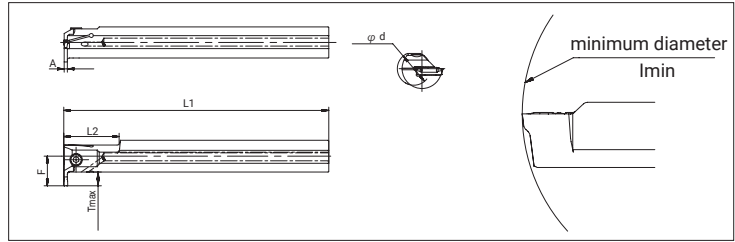
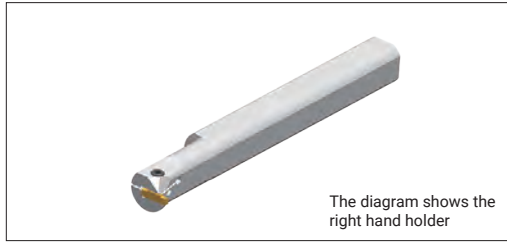

Product code	Dimension(mm)							Minimum machining diameter of internal grooving inserts lmin(mm)								Inserts*
	d	L1	L2	F	A	Tmax	Dmin	TS	TM	Ground	RM	RA	CS	CM	CH	
ATPIR/L	20-2T6-25-C	20	160	40	15.8	1.6	6	25	25	-	25	25	-	-	-	-
	25-2T5-25-C	25	200	40	17.5	1.6	5	25	25	-	25	25	-	-	-	-
	32-2T5-30-C	32	250	40	19.8	1.6	5	30	25	-	25	25	-	-	-	-
	20-3T6-25-C	20	160	40	15.8	2.1	6	25	25	25	25	25	25	-	-	-
	25-3T5-25-C	25	200	40	17.5	2.1	5	25	25	25	25	25	25	-	-	-
	25-3T8-32-C	25	200	40	21.5	2.4	8	32	25	25	25	25	25	-	-	-
	32-3T5-30-C	32	250	60	19.8	2.1	5	30	25	25	25	25	25	-	-	-
	32-3T10-40-C	32	200	60	27	2.4	10	40	25	25	25	25	25	-	-	-
	40-3T12-50-C	40	300	65	33	2.4	12	50	25	25	25	25	25	45	45	45
	20-4T6-25-C	20	160	40	15.8	3	6	25	25	25	25	25	25	-	-	-
	25-4T5-25-C	25	200	40	17.5	2.9	5	25	25	25	25	25	25	-	-	-
	25-4T8-32-C	25	200	40	21.5	3	8	32	25	25	25	25	25	-	-	-
	32-4T5-30-C	32	250	60	20.8	2.9	5	30	25	25	25	25	25	-	-	-
	32-4T10-40-C	32	250	60	27	3	10	40	25	25	25	25	25	-	-	-
	40-4T12-50-C	40	300	65	33	3	12	50	25	25	25	25	25	-	45	45
	50-4T14-60-C	50	350	70	40	3	14	60	25	25	25	25	25	-	45	45
	25-5T5-31-C	25	200	40	17.3	3.9	5	31	30	30	30	30	30	-	-	-
	32-5T5-31-C	32	250	60	20.8	3.9	5	31	30	30	30	30	30	-	-	-
	32-5T10-40-C	32	250	60	27	3.85	10	40	30	30	30	30	30	-	-	-
	40-5T12-50-C	40	300	65	33	3.85	12	50	30	30	30	30	30	-	45	45
50-5T14-60-C	50	350	70	40	3.85	14	60	30	30	30	30	30	-	45	45	
32-6T5-31-C	32	250	60	20.8	4.9	5	31	30	30	30	30	30	-	-	-	
32-6T10-40-C	32	250	60	27	4.85	10	40	30	30	30	30	30	-	-	-	
40-6T12-50-C	40	300	65	33	4.85	12	50	30	30	30	30	30	-	45	45	
50-6T14-60-C	50	350	70	40	4.85	14	60	30	30	30	30	30	-	45	45	
32-8T6-38-C	32	250	60	21.3	5.85	6	38	32	32	32	32	32	-	-	-	
40-8T6-42-C	40	300	65	25.8	5.85	6	42	32	32	32	32	32	-	-	-	

- 1.Inserts*: ACD/ACS series are only applicable to grooving machining
- 2."- "Indicates that the insert is not a choice
- 3.Having selected the range of tool holder, please check the minimum face grooving machining diameter of the selected insert

Product code	Screw	Wrench
ATPIR/L 20-2/3/4	SH050120	LT-H4
ATPIR/L 25-2/3/4	SH050160	LT-H4
ATPIR/L 32-3/4	SH050160	LT-H4
ATPIR/L 40-3/4	SH050160	LT-H4
ATPIR/L 50-4	SH050200	LT-H4
ATPIR/L 25-5	SH060160	LT-H5
ATPIR/L 32-5/6/8	SH060200	LT-H5
ATPIR/L 40/50-5/6/8	SH060250	LT-H5



ATSIR/L Internal Facing Grooving and Turning Holder

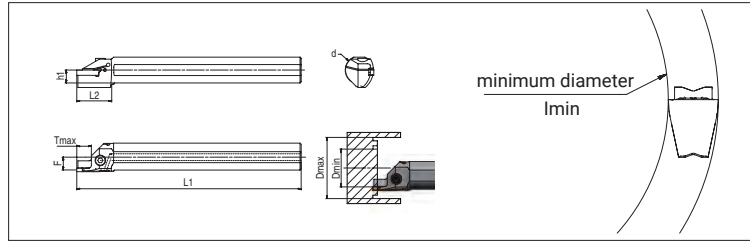
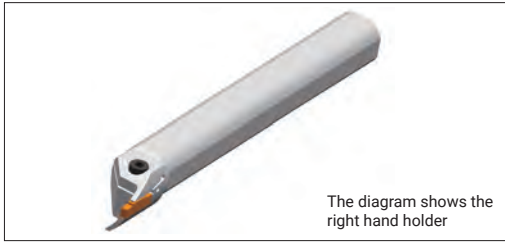
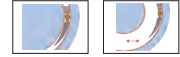

Product code	Dimension(mm)									Minimum machining diameter of face grooving inserts lmin(mm)							Inserts*
	d	L1	L2	F	h1	Tmax	Dmin	Dmax	TS	TM	Ground	RM	CS	CM	CH		
ATSIR/L	25-3T12-35-45-C	25	200	31	11.5	11.5	12	35	45	24	24	-	-	-	-	-	ACD/ ACS/ ATD
	25-3T12-40-60-C	25	200	31	11.5	11.5	12	40	60	24	24	-	-	-	-	-	
	25-3T12-55-90-C	25	200	31	11.5	11.5	12	55	90	24	24	59	59	-	-	-	
	25-3T12-80-150-C	25	200	31	11.5	11.5	12	80	150	24	24	59	59	79	79	79	
	25-4T12-20-35-C	25	200	31	11	11.5	12	20	35	22	22	-	-	-	-	-	
	25-4T12-28-45-C	25	200	31	11	11.5	12	28	45	22	22	-	-	-	-	-	
	25-4T12-35-55-C	25	200	31	11	11.5	12	35	55	22	22	42	42	-	42	42	
	32-4T12-45-70-C	32	250	31	14.5	15	12	45	70	22	22	42	42	-	42	42	
	32-4T12-60-100-C	32	250	31	14.5	15	12	60	100	22	22	42	42	-	42	42	
	32-4T12-90-180-C	32	250	31	14.5	15	12	90	180	22	22	42	42	-	42	42	

- 1.Inserts*: ACD/ACS series are only applicable to grooving machining
- 2."-"Indicates that the insert is not a choice
- 3.Having selected the range of tool holder, please check the minimum face grooving machining diameter of the selected insert

Product code	Screw	Wrench
ATSIR/L 25-3/4	SH050160	LT-H4
ATPIR/L 32-4	SH050160	LT-H4



AGSIR/L Internal Facing Grooving and Turning Holder

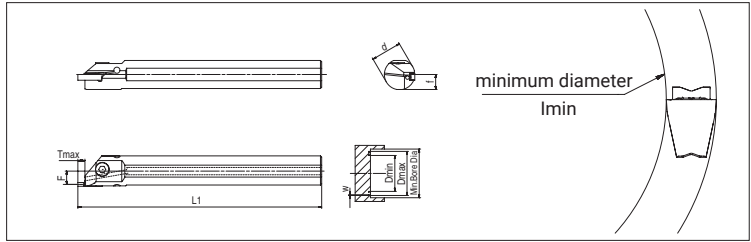
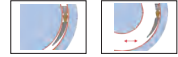

Product code		Inserts size (mm)	Dimension(mm)					Minimum machining diameter of face grooving inserts lmin(mm)							Inserts*
			d	L1	H1	F	Tmax	TS	TM	Ground	RM	CS	CM	CH	
AGSIR/L	25-4T5-C	2	25	200	12.3	10.9	5.8	196	-	100	196	196	196	196	ACD/ACS/ATD
		3	25	200	12.3	10.9	5.8	24	24	59	59	79	79		
		4	25	200	12.3	10.9	5.8	22	22	42	42	-	42	42	
	25-6T5-C	5	25	200	12.3	10.3	5.8	20	20	40	40	-	50	50	
		6	25	200	12.3	10.3	5.8	18	18	38	38	-	48	48	
	32-4T5-C	2	32	250	15.8	14.5	5.8	196	-	100	196	196	196	196	
		3	32	250	15.8	14.5	5.8	24	24	59	59	79	79	79	
		4	32	250	15.8	14.5	5.8	22	22	42	42	-	42	42	
	32-6T5-C	5	32	250	15.8	13.79	5.8	20	20	40	40	-	50	50	
		6	32	250	15.8	13.79	5.8	18	18	38	38	-	48	48	

1. Inserts*: ACD/ACS series are only applicable to grooving machining
2. "-" Indicates that the insert is not a choice
3. Having selected the range of tool holder, please check the minimum face grooving machining diameter of the selected insert

Product code	Screw	Wrench
AGSIR/L 25	SH060160	LT-H4
AGSIR/L 32	SH060160	LT-H4



AGUIR/L Internal Under Cut Machining Holder

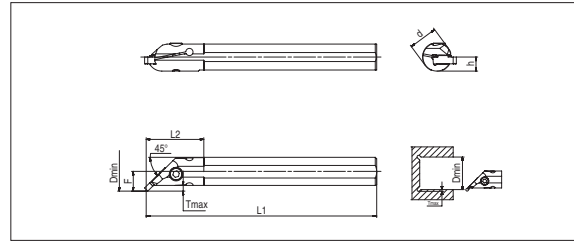
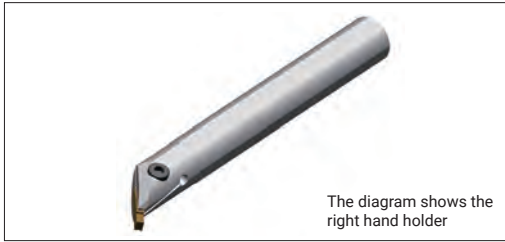

Product code		Dimension(mm)						Inserts*
		d	L1	L2	F	Tmax	Dmin	
AGUIR/L	20-3T3-45	20	160	40	12.3	3	45	ACD/ACS/ATD
	20-4T3-45	20	160	40	12.3	3	45	
	25-3T3-45	25	200	40	14.4	3	45	
	25-4T3-45	25	200	40	14.4	3	45	
	25-6T3-45	25	200	40	14.4	3	45	





Product code	Screw	Wrench
AGUIR/L 20-3	SH050120	LT-H4
AGUIR/L 20-4	SH050120	LT-H4
AGUIR/L 25-3	SH050160	LT-H4
AGUIR/L 25-4	SH050160	LT-H4
AGUIR/L 25-6	SH060160	LT-H5



Insert Denomination System

A	C	D	4	0	3	-	CM	-	6	R
1	2	3	4	5		-	6	-	7	8



1-Company name ACHTECK	2-Application C Grooving/Parting off T Turning/Grooving	3-Insert shape S Single-edged D Double-edged	4-Insert width  2=2.0mm 3=3.0mm 4=4.0mm
----------------------------------	--	---	---

5-Corner radius  02=0.2mm 03=0.3mm 04=0.4mm	6-Geometry  CS CM CH TS	7-Cutting edge angle  6 15	8-Hand of tool  L: Left  R: Right
---	--	---	---

Insert Denomination System (Ground)















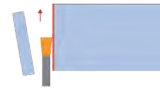

A	T	D	215	E	010	G	-	R/L
1	2	3	4	5	6	7	-	8

1-Company name ACHTECK	2-Application T Turning/Grooving	3-Insert shape S Single-edged D Double-edged	4-Insert width  2=2.0mm 3=3.0mm 4=4.0mm
----------------------------------	--	---	---

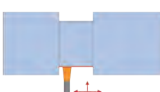
5-Application E: External F: Facing I: Internal	6-Corner radius  010=0.10mm 020=0.20mm 200=2.00mm	7-Application limited G only applicable to parting off	8-insert direction  L: left hand  R: right hand
---	---	--	--

Grooving inserts

Overview of Grooving Inserts

Inserts* Application			ACD			ATD				
			CS	CM	CH	TS	TM	RM	RA	G
										
Page			P124	P125	P126	P127	P128	P129	P130	P131-133
External grooving	Parting off		●	●	●	◐	◐			
	Grooving		●	●	●	●	●	●		●
	Turning					●	●	●	◐	◐
	Profiling							●	●	◐
	Under cut							●	●	◐
Face grooving	Grooving		◐	◐	◐	●	●			●
	Turning					●	●			◐
Internal machining	Grooving		◐	◐	◐	●	●			●
	Turning					●	●	◐		◐

Marked : ● Best choice
◐ 2nd choice





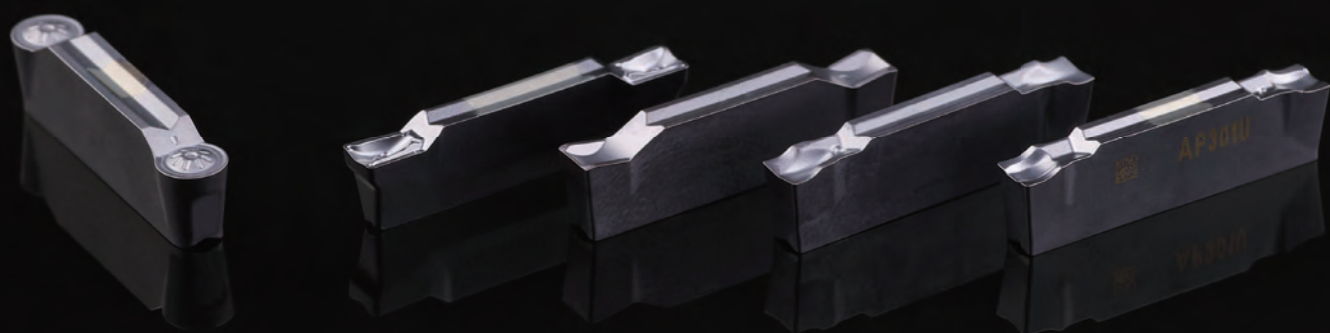





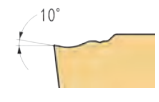

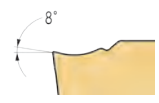
ACHTTECK

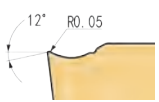
www.achtecktool.com

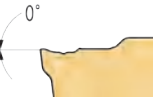

Grooving inserts

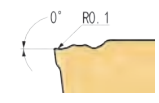
Insert Geometry Introduction

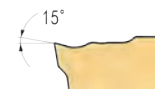
Inserts	Geometry	Shape of cutting edge	Description
	CS		<ol style="list-style-type: none"> Used in parting off & grooving stainless steel, heat resistant alloy and low carbon steel For low feed rate application
	CM		<ol style="list-style-type: none"> Used in parting off & grooving low carbon steel and stainless steel For sticky material, pipe fitting, thin-walled part parting off, low cutting force For low to medium feed rate
	CH		<ol style="list-style-type: none"> Used in parting off and grooving steel with high hardness and toughness, alloy steel and stainless steel Strong cutting edge For parting off and grooving at medium to high feed rate
	TS		<ol style="list-style-type: none"> Multifunctional insert for external, internal turning and grooving, parting off, face grooving and face turning Excellent chip control For low and medium feed rate. There is a wider machining diameter range in the internal grooving and face grooving.
	TM		<ol style="list-style-type: none"> Multifunctional insert for external, internal turning and grooving, parting off, face grooving and face turning Stronger cutting edge design For medium feed rate
	RM		<ol style="list-style-type: none"> External grooving, turning, profiling Medium feed rate
	RA		<ol style="list-style-type: none"> For turning and profiling aluminum alloy High positive rake angle and sharp cutting edge Ground inserts with high precision

Grade Application Guide

Grooving grade ISO group						
Material	Materials	ISO	PVD coated	Uncoated	ISO	
			AP301U	AW100K		
P	Unalloy steels / Alloyed steels	P01			P01	
		P05			P05	
		P10			P10	
		P15	AP301U			P15
		P20				P20
		P25				P25
		P30				P30
		P35				P35
		P40			P40	
		P45			P45	
		P50			P50	
M	Stainless steels	M01			M01	
		M05			M05	
		M10			M10	
		M15	AP301U			M15
		M20				M20
		M25				M25
		M30				M30
		M35				M35
		M40			M40	
M45			M45			
K	Cast iron	K01			K01	
		K05			K05	
		K10			K10	
		K15	AP301U			K15
		K20				K20
		K25				K25
		K30				K30
		K35				K35
		K40			K40	
		K45			K45	
K50			K50			
S	Heat resistant alloys	S01			S01	
		S05			S05	
		S10			S10	
		S15			S15	
		S20			S20	
		S25			S25	
		S30			S30	
		S35			S35	
		S40			S40	
N	Aluminum/ Aluminum alloys	N01			N01	
		N05		AW100K	N05	
		N10			N10	
		N15			N15	
		N20			N20	
		N25			N25	
		N30			N30	
H	Hardened steels/ Chilled cast iron	H01			H01	
		H05			H05	
		H10			H10	
		H15			H15	
		H20			H20	
		H25			H25	
H30			H30			

Grooving inserts

Grade Application Guide

Materials				Turning grade application	
				PVD coated	Uncoated
ISO	Material classification	Tensile strength (N/mm ²)	Hardness (HB)	AP301U	AW100K
P	Unalloyed steel	<600	<180	●	-
		<950	<280	●	-
	Alloyed steel	700-950	200-280	●	-
		950-1200	280-355	●	-
		1200-1400	355-415	●	-
M	Duplex stainless steel	778	230	●	-
	Austenitic stainless steel	675	200	●	-
	Precipitation-hardening stainless steel	1013	300	●	-
K	Grey cast iron	700	220	◐	-
	Nodular cast iron	880	260	◐	-
	Malleable cast iron	800	250	◐	-
S	Fe-based alloy	943	280	-	-
	Co-based alloy	1076	320	-	-
	Ni-based alloy	1177	350	-	-
	Ti-alloy	1262	370	-	-
N	Aluminum	260	75	-	●
	Aluminum alloy	447	130	-	●
H	Hardened steel	-	50-60HRC	-	-
	Chilled cast iron	-	55HRC	-	-

- Best choice
- ◐ 2nd choice
- Inapplicable

Grooving Grade Description

AP301U

Coating: PVD coating

Suitable for steel, stainless steel and heat resistant alloy grooving. High strength and wear resistance submicron carbide substrate with multi layer nanostructured PVD coating. Good coating adhesion. High wear resistance.

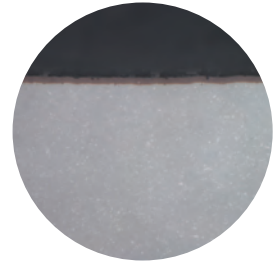

Application range												
ISO Classification	01	05	10	15	20	25	30	35	40	45	50	
P				AP301U								
M				AP301U								
K				AP301U								
S												
N												
H												

Remark : Best choice
 2nd choice

AW100K

Coating: uncoated

Uncoated ultra-fine grain substrate, specially treated cutting edge, suitable for aluminum alloy grooving

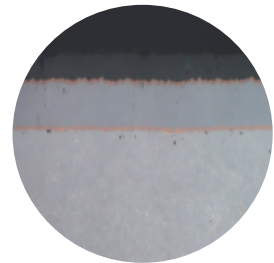

Application range											
ISO Classification	01	05	10	15	20	25	30	35	40	45	50
P											
M											
K											
S											
N		AW100K									
H											

Remark : Best choice

Grooving inserts

Parting Off-Grooving Series

CM: Double-edged, single-edged inserts applicable to parting off and grooving

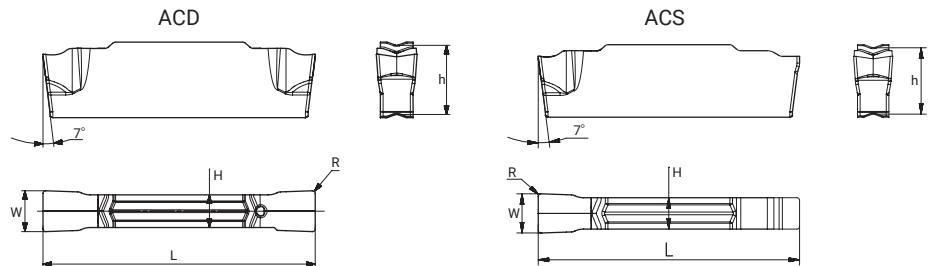

Inserts	Product code	Cutting parameter		Dimension(mm)					Grade	
		Tmax	Feed (mm/rev)	W	R	L	H	h	AP301U	AW100K
	ACD 202-CM	19.7	0.04-0.15	2	0.2	20.0	1.7	5.1	●	
	ACD 202-CM-6R	19.7	0.03-0.09	2	0.2	20.7	1.7	5.1	●	
	ACD 202-CM-6L	19.7	0.03-0.09	2	0.2	20.7	1.7	5.1	●	
	ACD 202-CM-15R	19.7	0.03-0.09	2	0.2	21.0	1.7	5.1	●	
	ACD 202-CM-15L	19.7	0.03-0.09	2	0.2	21.0	1.7	5.1	●	
	ACD 302-CM	19.7	0.05-0.16	3	0.2	20.0	2.4	5.1	●	
	ACD 302-CM-6R	19.7	0.04-0.14	3	0.2	20.7	2.4	5.1	●	
	ACD 302-CM-6L	19.7	0.04-0.14	3	0.2	20.7	2.4	5.1	●	
	ACD 302-CM-15R	19.7	0.04-0.14	3	0.2	21.0	2.4	5.1	●	
	ACD 302-CM-15L	19.7	0.04-0.14	3	0.2	21.0	2.4	5.1	●	
	ACD 403-CM	19.7	0.06-0.18	4	0.3	20.0	3.0	5.1	●	
	ACD 403-CM-4R	19.7	0.05-0.16	4	0.3	20.7	3.0	5.1	●	
	ACD 403-CM-4L	19.7	0.05-0.16	4	0.3	20.7	3.0	5.1	●	
	ACD 503-CM	24.7	0.06-0.20	5	0.3	25.0	4.0	5.0	●	
	ACD 503-CM-4R	24.7	0.06-0.18	5	0.3	25.7	4.0	5.0	○	
	ACD 503-CM-4L	24.7	0.06-0.18	5	0.3	25.7	4.0	5.0	○	
ACD 603-CM	29.7	0.06-0.22	6	0.3	25.0	5.0	5.0	●		
	ACS 202-CM	19.7	0.04-0.15	2	0.2	20.0	1.7	5.1	●	
	ACS 302-CM	19.7	0.05-0.16	3	0.2	20.0	2.4	5.1	●	
	ACS 403-CM	19.7	0.06-0.18	4	0.3	20.0	3.0	5.1	○	
	ACS 503-CM	24.7	0.06-0.20	5	0.3	25.0	4.0	5.0	○	
	ACS 603-CM	29.7	0.06-0.22	6	0.3	25.0	5.0	5.0	○	

Remark: 1. if R/L style inserts are selected, the feed need to be reduced by 20-40%
 2. ACS single edged insert's Tmax is determined according to the tool holder.

Marked : ● Stock available ○ Non-stocked standard



Parting Off-Grooving Series

CH: Double-edged, single-edged inserts applicable to parting off and grooving

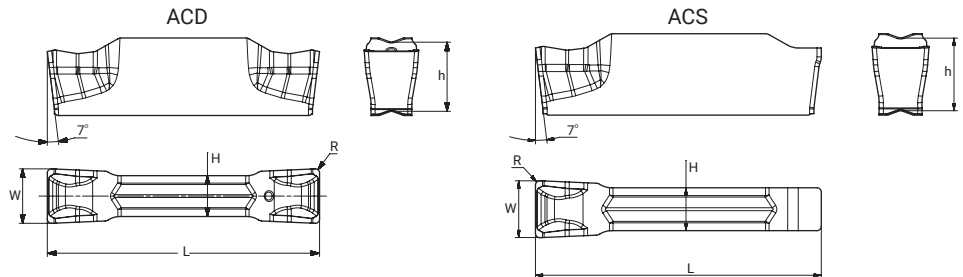

inserts*	Product code	Cutting parameter		Dimension(mm)					Grade	
		Tmax	Feed (mm/rev)	W	R	L	H	h	AP301U	AW100K
	ACD 202-CH	19.7	0.05-0.20	2	0.2	20.0	1.7	5.1	●	
	ACD 202-CH-6R	19.7	0.04-0.16	2	0.2	20.7	1.7	5.1	●	
	ACD 202-CH-6L	19.7	0.04-0.16	2	0.2	20.7	1.7	5.1	●	
	ACD 202-CH-15R	19.7	0.04-0.15	2	0.2	21.0	1.7	5.1	●	
	ACD 202-CH-15L	19.7	0.04-0.15	2	0.2	21.0	1.7	5.1	●	
	ACD 302-CH	19.7	0.07-0.25	3	0.2	20.0	2.4	5.1	●	
	ACD 302-CH-6R	20.7	0.05-0.20	3	0.2	20.7	2.4	5.1	●	
	ACD 302-CH-6L	21.7	0.05-0.20	3	0.2	20.7	2.4	5.1	●	
	ACD 302-CH-15R	20.0	0.05-0.18	3	0.2	21.0	2.4	5.1	●	
	ACD 302-CH-15L	20.0	0.05-0.18	3	0.2	21.0	2.4	5.1	●	
	ACD 403-CH	19.0	0.08-0.30	4	0.3	20.0	3.0	5.1	●	
	ACD 403-CH-4R	19.7	0.06-0.25	4	0.3	20.7	3.0	5.1	●	
	ACD 403-CH-4L	19.7	0.06-0.25	4	0.3	20.7	3.0	5.1	●	
	ACD 503-CH	24.0	0.09-0.35	5	0.3	25.0	4.0	5.0	●	
	ACD 503-CH-4R	24.7	0.08-0.30	5	0.3	25.7	4.0	5.0	●	
	ACD 503-CH-4L	25.7	0.08-0.30	5	0.3	25.7	4.0	5.0	●	
ACD 603-CH	24.0	0.12-0.40	6	0.3	25.0	5.0	5.0	●		
ACD 804-CH	29.0	0.15-0.45	8	0.4	30.0	6.0	6.1	●		
	ACS 202-CH	-	0.05-0.20	2	0.2	20.0	1.7	5.1	●	
	ACS 302-CH	-	0.07-0.25	3	0.2	20.0	2.4	5.1	●	
	ACS 403-CH	-	0.08-0.30	4	0.3	20.0	3.0	5.1	●	
	ACS 503-CH	-	0.09-0.35	5	0.3	20.0	4.0	5.0	●	
	ACS 603-CH	-	0.12-0.40	6	0.3	25.0	5.0	5.0	○	

Remark: 1. if R/L style inserts are selected, the feed need to be reduced by 20-40%
 2. ACS single edged insert's Tmax is determined according to the tool holder.

Marked : ● Stock available ○ Non-stocked standard



Grooving-Turning Series

TS: Double-edged inserts applicable to external, internal and face turning, grooving and parting off

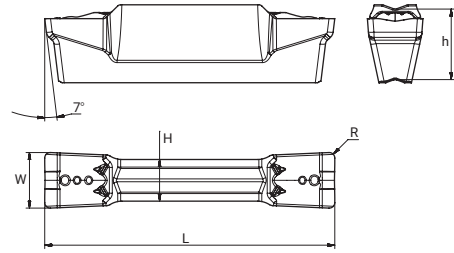

inserts*	Product code	Cutting parameter				Dimension(mm)					Grade	
		Grooving	Tmax	Turning		W	R	L	H	h	AP301U	AW100K
		Feed (mm/rev)		Feed (mm/rev)	Ap (mm)							
	ATD 203-TS	0.04-0.20	19.7	0.12-0.19	0.40-1.50	2	0.3	20.7	1.7	5.1	●	
	ATD 303-TS	0.05-0.25	19.7	0.15-0.23	0.45-2.00	3	0.3	20.7	2.2	5.1	●	
	ATD 404-TS	0.06-0.27	19.7	0.18-0.25	0.50-2.50	4	0.4	20.7	3.0	5.1	●	
	ATD 408-TS	0.06-0.27	19.7	0.18-0.25	1.00-2.50	4	0.8	20.7	3.0	5.1	●	
	ATD 504-TS	0.07-0.30	24.7	0.20-0.30	0.55-3.50	5	0.4	25.7	4.0	5.0	●	
	ATD 508-TS	0.07-0.30	24.7	0.20-0.30	1.00-3.50	5	0.8	25.7	4.0	5.0	●	
	ATD 604-TS	0.10-0.40	24.7	0.22-0.45	0.65-3.80	6	0.4	25.7	5.0	5.0	●	
	ATD 608-TS	0.10-0.40	24.7	0.22-0.45	1.00-3.80	6	0.8	25.7	5.0	5.0	○	
	ATD 808-TS	0.12-0.45	30.5	0.28-0.50	1.00-4.50	8	0.8	31.5	6.0	6.1	○	

Marked : ● Stock available ○ Non-stocked standard

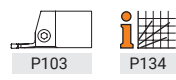

Grooving inserts

Grooving-Turning Series

TM: Double-edged inserts applicable to external, internal and face turning, grooving and parting off

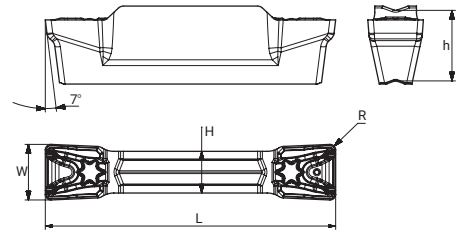

inserts*	Product code	Cutting parameter				Dimension(mm)					Grade	
		Grooving	Tmax	Turning		W	R	L	H	h	AP301U	AW100K
		Feed (mm/rev)		Feed (mm/rev)	Ap Ap(mm)							
	ATD 304-TM	0.10-0.25	19.7	0.15-0.22	0.50-2.0	3	0.4	20.7	2.2	5.1	●	
	ATD 404-TM	0.15-0.30	19.7	0.18-0.27	0.50-2.5	4	0.4	20.7	3.0	5.1	●	
	ATD 408-TM	0.15-0.30	19.7	0.18-0.27	1.00-2.5	4	0.8	20.7	3.0	5.1	●	
	ATD 504-TM	0.18-0.35	24.7	0.20-0.35	0.55-3.5	5	0.4	25.7	4.0	5.0	●	
	ATD 508-TM	0.18-0.35	24.7	0.20-0.35	1.00-3.5	5	0.8	25.7	4.0	5.0	●	
	ATD 604-TM	0.20-0.45	24.7	0.22-0.45	0.65-4.0	6	0.4	25.7	5.0	5.0	●	
	ATD 608-TM	0.20-0.45	24.7	0.22-0.45	1.00-4.0	6	0.8	25.7	5.0	5.0	●	
	ATD 808-TM	0.22-0.50	30.5	0.28-0.50	1.00-5.0	8	0.8	31.5	6.0	6.1	○	
	ATD 812-TM	0.22-0.50	30.5	0.28-0.50	1.50-5.0	8	1.2	31.5	6.0	6.1	●	

Marked : ● Stock available ○ Non-stocked standard



Grooving-Turning Series

RM: Double-edged inserts applicable to external turning, grooving and profiling

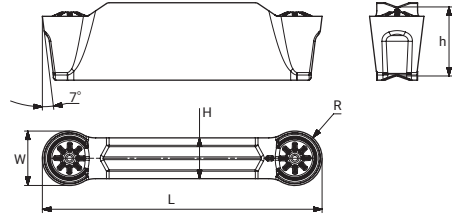

inserts*	Product code	Cutting parameter			Dimension(mm)					Grade	
		Grooving	Turning		W	R	L	H	h	AP301U	AW100K
		Feed (mm/rev)	Feed (mm/rev)	Ap (mm)							
	ATD 210-RM	0.06-0.15	0.12-0.25	0.4-1.0	2	1.0	20.7	1.7	5.1	●	
	ATD 315-RM	0.08-0.18	0.15-0.30	0.5-1.5	3	1.5	20.7	2.2	5.1	●	
	ATD 420-RM	0.10-0.20	0.18-0.35	0.6-2.0	4	2.0	20.7	3.0	5.1	●	
	ATD 525-RM	0.12-0.25	0.20-0.40	0.7-2.5	5	2.5	25.7	4.0	5.0	●	
	ATD 630-RM	0.15-0.30	0.25-0.50	0.9-3.0	6	3.0	25.7	5.0	5.0	●	
	ATD 840-RM	0.18-0.35	0.30-0.60	1.0-4.0	8	4.0	31.5	6.0	6.1	●	

Marked : ● Stock available ○ Non-stocked standard



Grooving-Turning Series

RA: Double-edged ground inserts applicable to aluminium wheel turning and profiling

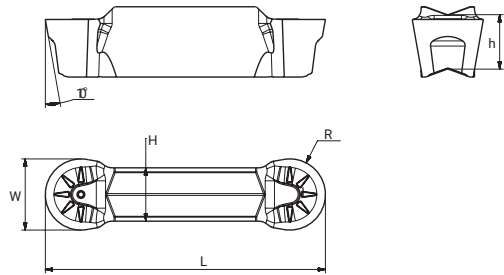

inserts*	Product code	Cutting parameter			Dimension(mm)					Grade	
		Grooving	Turning		W	R	L	H	h	AP301U	AW100K
		Feed (mm/rev)	Feed (mm/rev)	Ap (mm)							
	ATD 315-RA	0.08-0.18	0.15-0.30	0.5-1.5	3	1.5	20.7	2.2	5.1	●	○
	ATD 420-RA	0.10-0.25	0.20-0.45	0.6-0.2	4	2.0	20.7	3.0	5.1	●	○
	ATD 525-RA	0.11-0.28	0.20-0.50	0.7-2.5	5	2.5	25.7	4.0	5.0	●	○
	ATD 630-RA	0.12-0.30	0.22-0.60	0.9-3.0	6	3.0	25.7	5.0	5.0	●	○
	ATD 840-RA	0.15-0.40	0.25-0.65	1.0-4.0	8	4.0	31.5	6.0	6.1	●	○

Marked : ● Stock available ○ Non-stocked standard



Grooving Series

Ground inserts applicable to grooving

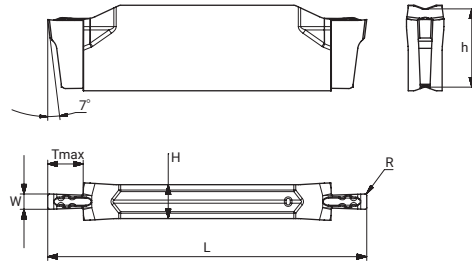

inserts*	Product code	Suitable tool holder	Cutting parameter		Dimension(mm)					Grade		
			Grooving	Feed (mm/rev)	W	R	Tmax	H	h	L	AP301U	AW100K
	ATD 100E000G	2mm	0.02-0.05	1.00	0.00	2.00	2.20	5.1	20.700	●		
	ATD 104E000G	2mm	0.02-0.05	1.04	0.00	2.00	2.20	5.1	20.700	●		
	*ATD 115E000G	2mm	0.02-0.05	1.15	0.00	2.00	2.20	5.1	20.700	●		
	ATD 120E000G	2mm	0.03-0.05	1.20	0.00	2.00	2.20	5.1	20.700	●		
	ATD 125E010G	2mm	0.03-0.05	1.25	0.10	2.00	2.20	5.1	20.700	●		
	*ATD 130E000G	2mm	0.03-0.05	1.30	0.00	2.00	2.20	5.1	20.700	●		
	ATD 135E000G	2mm	0.03-0.05	1.35	0.00	2.00	2.20	5.1	20.700	●		
	ATD 140E000G	2mm	0.03-0.06	1.40	0.00	2.00	2.20	5.1	20.700	●		
	ATD 145E010G	2mm	0.03-0.06	1.45	0.10	2.00	2.20	5.1	20.700	●		
	ATD 147E000G	2mm	0.03-0.06	1.47	0.00	2.50	2.20	5.1	20.700	●		
	ATD 150E010G	2mm	0.03-0.06	1.50	0.10	2.50	2.20	5.1	20.700	●		
	ATD 157E015G	2mm	0.03-0.07	1.57	0.15	2.70	2.20	5.1	20.700	●		
	*ATD 165E010G	2mm	0.03-0.07	1.65	0.10	2.70	2.20	5.1	20.700	●		
	ATD 170E010G	2mm	0.03-0.07	1.70	0.10	3.00	2.20	5.1	20.700	●		
	ATD 178E018G	2mm	0.03-0.07	1.78	0.18	3.00	2.20	5.1	20.700	●		
	*ATD 190E010G	2mm	0.04-0.09	1.90	0.10	3.00	2.20	5.1	20.700	●		
	ATD 196E015G	2mm	0.04-0.09	1.96	0.15	3.00	2.20	5.1	20.700	●		
	ATD 200E020G	2mm	0.04-0.09	2.00	0.20	3.00	2.20	5.1	20.700	●		
	*ATD 215E010G	2mm	0.04-0.10	2.15	0.10	3.00	2.20	5.1	20.700	●		
	ATD 222E015G	2mm	0.04-0.10	2.22	0.15	3.50	2.20	5.1	20.700	●		
	ATD 230E020G	2mm	0.04-0.10	2.30	0.20	3.50	2.20	5.1	20.700	●		
	ATD 100E050G	2mm	0.03-0.06	1.00	0.50	2.00	2.20	5.1	20.700	●		
	ATD 140E070G	2mm	0.04-0.07	1.40	0.70	2.00	2.20	5.1	20.700	●		
	ATD 157E079G	2mm	0.04-0.08	1.57	0.78	2.70	2.20	5.1	20.700	●		
	ATD 200E100G	2mm	0.05-0.11	2.00	1.00	3.00	2.20	5.1	20.700	●		
	ATD 239E120G	2mm	0.06-0.12	2.39	1.19		2.20	5.1	20.700	●		

1. * For circlip grooves

2. When the width of the insert is less than 1.78mm, please pay attention to size A of the holder

Marked : ● Stock available ○ Non-stocked standard



Grooving Series

Ground inserts applicable to profiling, turning and grooving

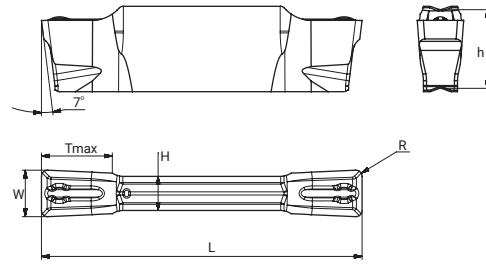

inserts*	Product code	Suitable tool holder	Cutting parameter			Dimension(mm)						Grade	
			Grooving Feed (mm/rev)	Turning		W	R	Tmax	H	h	L	AP301U	AW100K
				Feed (mm/rev)	Ap (mm)								
	ATD 265E015	3mm	0.04-0.12	0.10-0.18	0.20-1.80	2.65	0.15	-	2.20	5.1	20.70	●	
	ATD 300E020	3mm	0.06-0.14	0.11-0.20	0.30-2.00	3.00	0.20	-	2.20	5.1	20.70	●	
	ATD 300E040	3mm	0.06-0.15	0.15-0.23	0.50-2.20	3.00	0.40	-	2.20	5.1	20.70	●	
	ATD 400E040	4mm	0.08-0.19	0.16-0.30	0.50-2.50	4.00	0.40	-	3.00	5.1	20.70	●	
	ATD 400E080	4mm	0.08-0.19	0.16-0.30	1.00-2.50	4.00	0.80	-	3.00	5.1	20.70	●	
	ATD 415E015	4mm	0.08-0.19	0.16-0.30	0.20-2.50	4.15	0.15	-	3.00	5.1	20.70	●	
	ATD 478E055	5mm	0.10-0.20	0.20-0.35	0.60-2.60	4.78	0.55	-	4.00	5.0	25.70	●	
	ATD 500E040	5mm	0.10-0.20	0.20-0.35	0.50-2.60	5.00	0.40	-	4.00	5.0	25.70	●	
	ATD 500E080	5mm	0.10-0.20	0.22-0.35	1.00-3.00	5.00	0.80	-	4.00	5.0	25.70	●	
	ATD 515E015	5mm	0.10-0.22	0.22-0.35	0.20-3.00	5.15	0.15	-	4.00	5.0	25.70	●	
	ATD 555E055	6mm	0.12-0.28	0.23-0.40	0.60-3.00	5.55	0.55	-	5.00	5.0	25.70	●	
	ATD 600E080	6mm	0.12-0.30	0.25-0.45	1.00-3.50	6.00	0.80	-	5.00	5.0	25.70	●	
	ATD 600E120	6mm	0.12-0.30	0.25-0.45	1.30-3.50	6.00	1.20	-	5.00	5.0	25.70	●	
	ATD 635E080	6mm	0.13-0.30	0.25-0.45	1.00-3.50	6.35	0.80	-	5.00	5.0	25.70	●	
	ATD 800E080	8mm	0.15-0.40	0.30-0.55	1.00-4.80	8.00	0.80		6.00	6.1	31.50	●	
	ATD 800E120	8mm	0.15-0.40	0.30-0.55	1.20-4.80	8.00	1.20		6.00	6.1	31.50	●	

Marked : ● Stock available ○ Non-stocked standard



Grooving Series

Ground inserts applicable to turning and grooving

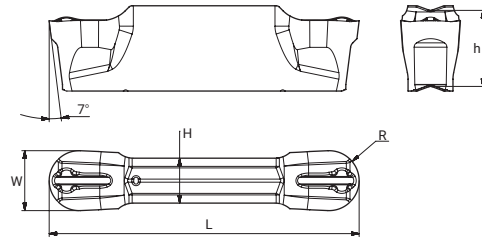

inserts*	Product code	Suitable tool holder	Cutting parameter			Dimension(mm)						Grade	
			Grooving	Turning		W	R	Tmax	H	h	L	AP301U	AW100K
			Feed (mm/rev)	Feed (mm/rev)	Ap (mm)								
	ATD 300E150	3mm	0.08-0.19	0.15-0.30	0-1.50	3.00	1.50	-	2.20	5.1	20.700	●	
	ATD 400E200	4mm	0.10-0.20	0.18-0.35	0-2.00	4.00	2.00	-	3.00	5.1	20.700	●	
	ATD 478E239	5mm	0.12-0.24	0.22-0.45	0-2.40	4.78	2.39	-	4.00	5.0	25.700	●	
	ATD 500E250	5mm	0.12-0.24	0.22-0.45	0-2.50	5.00	2.50	-	4.00	5.0	25.700	●	
	ATD 600E300	6mm	0.15-0.30	0.25-0.50	0-3.00	6.00	3.00	-	5.00	5.0	25.700	●	
	ATD 800E400	8mm	0.18-0.35	0.30-0.65	0-4.00	8.00	4.00	-	6.00	6.1	31.500	●	

Marked : ● Stock available ○ Non-stocked standard

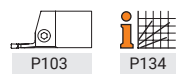

Cutting Parameter Recommendation of Parting Off and Grooving Application

Materials						Cutting parameter recommended table of parting off and grooving application						
ISO	Workpiece material				Brinell hardness (HB)	Tensile strength Rm(N/mm ²)	AP301U			AW100K		
							feed (mm/rev)					
							0.1	0.3	0.5	0.1	0.2	0.4
P	Unalloyed steel	C ≤ 0.25%	Annealed	125	428	180	145	130	-	-	-	
		0.25 < C ≤ 0.55%	Annealed	190	639	145	130	115	-	-	-	
		0.25 < C ≤ 0.55%	Heat-treated	210	708	130	115	100	-	-	-	
		C > 0.55%	Annealed	190	639	145	130	115	-	-	-	
		C > 0.55%	Heat-treated	300	1013	115	100	80	-	-	-	
		Free cutting steel (short-chip)	Annealed	220	745	130	115	100	-	-	-	
	Low-alloyed steel	Annealed		175	591	180	145	130	-	-	-	
		Heat-treated		300	1013	115	100	80	-	-	-	
		Heat-treated		380	1282	170	90	105	-	-	-	
		Heat-treated		430	1477	-	-	-	-	-	-	
	High-alloyed steel and high-alloyed tool steel	Annealed		200	675	-	-	-	-	-	-	
		Hardened and tempered		300	1013	-	-	-	-	-	-	
Hardened and tempered		400	1361	-	-	-	-	-	-			
Stainless steel	Ferritic/martensitic, annealed		200	675	165	135	105	-	-	-		
	Martensitic, heat-treated		330	1114	150	115	70	-	-	-		
M	Stainless steel	Austenitic, quench hardened		200	675	165	135	105	-	-	-	
		Austenitic, precipitation hardened (PH)		300	1013	155	120	80	-	-	-	
		Austenitic/ferritic, duplex		230	778	135	110	85	-	-	-	
K	Malleable cast iron	Ferritic		200	400	115	90	65	-	-	-	
		Pearlitic		260	700	115	90	65	-	-	-	
	Grey cast iron	Low tensile strength		180	200	185	140	95	-	-	-	
		High tensile strength/austenitic		245	350	185	140	95	-	-	-	
	Nodular cast iron	Ferritic		155	400	145	110	80	-	-	-	
		Pearlitic		265	700	145	110	80	-	-	-	
	GGV (CGI)		230	400	-	-	-	-	-	-		
N	Wrought aluminium alloys	non-aging		30	-	-	-	-	-	-	-	
		aged		100	340	-	-	-	-	-	-	
	Cast aluminium alloys	≤ 12% Si, non-aging		75	260	-	-	-	850	500	200	
		≤ 12% Si, aged		90	310	-	-	-	-	-	-	
		> 12% Si, non-aging		130	450	-	-	-	450	250	40	
	Magnesium alloys			70	250	-	-	-	-	-	-	
		Copper and copper alloys (bronze/brass)	Unalloyed, electrolytic copper		100	340	-	-	-	-	-	-
	Brass, bronze, red brass		90	310	-	-	-	-	-	-		
Cu alloys, short-chip			110	380	-	-	-	-	-	-		
High tensile, Ampco alloy			300	1010	-	-	-	-	-	-		
S	Heat-resistant alloys	Fe-based	Annealed	200	680	-	-	-	-	-	-	
			Hardened	280	940	-	-	-	-	-	-	
		Ni or Co based	Annealed	250	840	-	-	-	-	-	-	
			Hardened	350	1180	-	-	-	-	-	-	
	Titanium alloys	Pure titanium		200	680	-	-	-	-	-	-	
		α and β alloys, hardened		375	1260	-	-	-	-	-	-	
		β alloys		410	1400	-	-	-	-	-	-	
	Tungsten alloys	1177		300	1010	-	-	-	-	-	-	
Molybdenum alloys	1262		300	1010	-	-	-	-	-	-		
H	Hardened steel	Hardened and tempered		50HRC	-	-	-	-	-	-	-	
		Hardened and tempered		55HRC	-	-	-	-	-	-	-	
		Hardened and tempered		60HRC	-	-	-	-	-	-	-	
	Hardened cast steel	Hardened and tempered		50HRC	-	-	-	-	-	-	-	

*The recommended cutting conditions always refer to general conditions. These cutting conditions should be adjusted according to the practical machine rigidity, tools, workpiece clamping and coolant

ACHTTECK

www.achtecktool.com



CUTTING TOOL CATALOGUE

Milling cutters	136
Milling cutter denomination system	138
Overview of milling products	140
Milling cutters	148
Milling inserts	212
Milling insert denomination system	212
Geometry application guide	214
Grade application guide	216
Milling grade description	218
Milling inserts	224
Cutting parameter recommendation table	248

Milling Cutter Denomination System

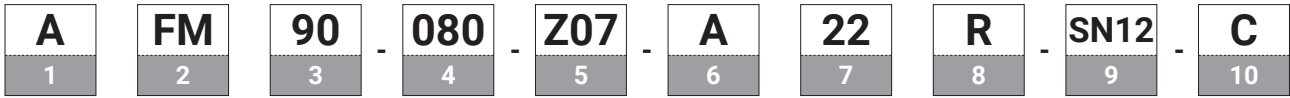

1. A--ACHTECK

2. Machining method	
Face milling	FM
Shoulder milling	SM
Profile milling	PM
High feed milling	HM
Side & face milling	DM
Thread milling	TM
Chamfer milling	CM

3. Approach angle (Kr)	
Figure	Angle
90	90°
88	88°
75	75°
60	60°
45	45°
42	42°
•	•
•	•
•	•
15	15
00	Round insert

4. Cutter dia.	
025	25mm
080	80mm
•	•
•	•
250	250mm

5. Number of teeth	
Z02	2 teeth
•	•
Z05	5 teeth
•	•
Z30	30 teeth

6. Connection	
A	Arbor
W	Weldon shank
C	Cylinder shank
N	Whistle notch shank
M	Screw clamped with modular head

7. Coupling Size
22--Connection diameter 22mm

8. Direction of tool	
R	Right
L	Left
N	Neutral

9. Insert info
SN12--SN12 series insert

10. Others	
C	Internal coolant
No mark	No coolant

Porcupine Cutter Denomination

A	PE	90	063	Z04	A	27	R	L13	L56	F	C
1	2	3	4	5	6	7	8	9	10	11	12

1. A--ACHTECK

2. Cutting method

Porcupine cutter	PE
Shoulder milling cutter	SM
Profile milling cutter	PM
High feed milling cutter	HM
Side and face Milling cutter	DM
Thread milling cutter	TM
Chamfer milling cutter	CM
Face milling cutter	FM

3. Approach angle (Kr)

Figure	Angle
90	90°
88	88°
75	75°
60	60°
45	45°
42	42°
•	•
•	•
•	•

4. Cutter dia.

025	25mm
063	63mm
080	80mm
•	•
250	250mm

5. Number of teeth

Z02	2 teeth
Z04	4 teeth
Z05	5 teeth
•	•
Z30	30 teeth

6. Coupling

A	Arbor
W	Weldon shank
C	Cylinder shank
N	Whistle notch shank
M	Screw clamped with modular head

7. Coupling size

27---Connection diameter 27mm

8. Direction of tool

R	Right
L	Left
N	Neutral

9. Insert information

LN13---LN13 series insert

10. Max. cutting depth

L30	30MM
L45	45MM
L56	56MM









11. Tool type

F	Full teeth
H	Half teeth

10. Others









C	With internal coolant
No indication	Without internal coolant

Overview of Milling Products

Product family			AFM42-OD04	AFM42-OD06	AFM40-ON05	AFM45-SD09	AFM75-SD09
Page			P148	P150	P152	P154	P156
Approach angle			42°	42°	40°	45°	75°
Max.ap (mm)			3.5	4.5	3	5	6
Diameter range (mm)			φ 32- φ 125	φ 50- φ 160	φ 50- φ 160	φ 16- φ 125	φ 25- φ 100
Insert type			OD..0404..	OD..0605..	ON..0504..	SD..09T3..	SD..09T3..
Application	Face milling		●	●	●	●	●
	Shoulder milling						
	Slot milling						
	Ramping		●	●		●	●
	Helical interpolate milling		●	●			
	Plunging						
	Profile milling						
	Chamfer milling		●	●		●	
	Pocket milling		●	●			

Remark: ● Recommended application









Overview of Milling Products

Product family			AFM90-SD09	AFM45-SD12	AFM75-SD12	AFM90-SD12	AFM45-SN12
Page			P158	P160	P162	P164	P166
Approach angle			90°	45°	75°	90°	45°
Max.ap (mm)			6	7	8	9	6.5
Diameter range (mm)			φ 25- φ 100	φ 50- φ 125	φ 50- φ 125	φ 50- φ 125	φ 50- φ 250
Insert type			SD..09T3..	SD..1204..	SD..1204..	SD..1204..	SN..1206..
Application	Face milling		●	●	●	●	●
	Shoulder milling						
	Slot milling						
	Ramping		●	●	●	●	
	Helical interpolate milling						
	Plunging						
	Profile milling						
	Chamfer milling			●			
	Pocket milling						

Remark: ● Recommended application







Milling cutters

Overview of Milling Products

Product family		AFM45-SN19	AFM75-SN12	AFM88-SN12	AFM45-XN07	AFM45-XN09(C)
Page		P166	P168	P170	P172	P174
Approach angle		45°	75°	88°	45°	45°
Max.ap (mm)		11	8	10	4	6
Diameter range (mm)		φ 160- φ 250	φ 50- φ 250	φ 50- φ 200	φ 40- φ 160	φ 63- φ 200
Insert type		SN..1909..	SN..1206..	SN..1206..	XN..0705..	XN..0906..
Application	Face milling		●	●	●	●
	Shoulder milling					
	Slot milling					
	Ramping					
	Helical interpolate milling					
	Plunging					
	Profile milling					
	Chamfer milling					
	Pocket milling					

Remark: ● Recommended application

Overview of Milling Products

Product family		AFM45-XN09(W)	AFF40-LN12	AFF40-LN15	ASM90-LN09	ASM90-LN13
Page		P174	P176	P176	P178	P180
Approach angle		45°	40°	40°	90°	90°
Max.ap (mm)		6	0.5	0.5	8	12
Diameter range (mm)		φ 80- φ 200	φ 80- φ 250	φ 80- φ 250	φ 20- φ 80	φ 40- φ 160
Insert type		XN..0906..	ON..0504.. LN..1204..	ON..0504.. LN..1506..	LNHU 0904..	LNHU 1306..
Application	Face milling		●	●	●	●
	Shoulder milling				●	●
	Slot milling				●	●
	Ramping					
	Helical interpolate milling					
	Plunging					
	Profile milling					
	Chamfer milling					
	Pocket milling					

Remark: ● Recommended application









Milling cutters

Overview of Milling Products

Product family		ASM90-LN16	ASM90-WN08	ASM90-AP10	ASM90-AP17	APE90-LN09	
Page		P182	P184	P186	P188	P190	
Approach angle		90°	90°	90°	90°	90°	
Max.ap (mm)		15	7	8	16	48	
Diameter range (mm)		φ 63- φ 160	φ 40- φ 160	φ 16- φ 63	φ 25- φ 63	φ 25- φ 50	
Insert type		LNHU 1607..	WN..0806..	APKT 1003..	APKT 1705..	LNHU 0904..	
Application	Face milling		●	●	●	●	●
	Shoulder milling		●	●	●	●	●
	Slot milling		●	●	●	●	
	Ramping				●	●	
	Helical interpolate milling				●	●	
	Plunging				●	●	
	Profile milling						
	Chamfer milling						
	Pocket milling				●	●	

Remark: ● Recommended application

Overview of Milling Products

Product family		APE90-LN13	APM00-RP	APM00-RO08	APM00-RO10	APM00-RO12
Page		P192	P194	P196	P198	P200
Approach angle		90°	-	-	-	-
Max.ap (mm)		56	-	4	5	6
Diameter range (mm)		φ 40- φ 80	φ 16- φ 20	φ 16- φ 25	φ 25- φ 50	φ 32- φ 80
Insert type		LNHU 1306..	RPM 080/100..	RO.. 0803..	RO..10T3..	RO..1204..
Application	Face milling		●		●	●
	Shoulder milling		●			
	Slot milling					
	Ramping			●	●	●
	Helical interpolate milling				●	●
	Plunging					
	Profile milling			●	●	●
	Chamfer milling					
	Pocket milling			●	●	●

Remark: ● Recommended application

Milling cutters

Overview of Milling Products

Product family			APM00-RO16	APM00-RO20	AHM20-LN06	AHM15-XD09	AHM15-XD12
Page			P202	P204	P206-207	P208	P210
Approach angle			-	-	20°	15°	15°
Max.ap (mm)			8	10	1.0	1.5	2.5
Diameter range (mm)			φ 63- φ 100	φ 100- φ 160	φ 16- φ 63	φ 25- φ 50	φ 32- φ 125
Insert type			RO..1605..	RO..2006..	LN..0604..	XD..0904..	XD..1205..
Application	Face milling		●	●	●	●	●
	Shoulder milling						
	Slot milling				●	●	●
	Ramping		●	●	●	●	●
	Helical interpolate milling		●	●	●	●	●
	Plunging				●	●	●
	Profile milling		●	●			
	Chamfer milling						
	Pocket milling		●	●	●	●	●

Remark: ● Recommended application

ACHTECK

www.achtecktool.com



Milling cutters

AFM42-OD04

42 ° Approaching angle face milling cutter

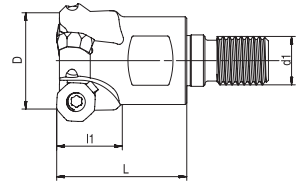
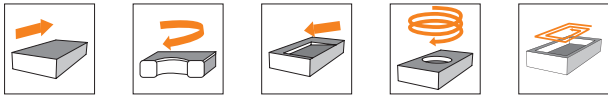

Product code	D	d1	L	apmax	Internal coolant	Z	Inserts
AFM42-032-Z03-M16R-OD04-C	32	M16	43	3.5		3	OD..0404

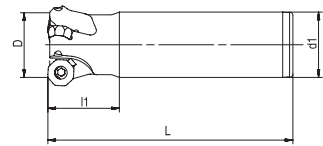

Product code	D	d1	L	apmax	Internal coolant	Z	Inserts
AFM42-032-Z03-W32R-OD04-C	32	32	120	3.5		3	OD..0404

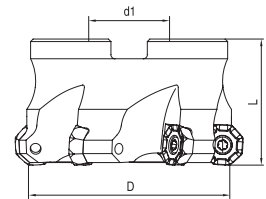

Product code	D	d1	L	apmax	Internal coolant	Z	Inserts
AFM42-040-Z04-A16R-OD04-C	40	16	40	3.5		4	OD..0404
AFM42-050-Z05-A16R-OD04-C	50	16	40	3.5		5	
AFM42-063-Z05-A22R-OD04-C	63	22	40	3.5		5	
AFM42-063-Z06-A22R-OD04-C	63	22	40	3.5		6	
AFM42-080-Z06-A27R-OD04-C	80	27	50	3.5		6	
AFM42-080-Z08-A27R-OD04-C	80	27	50	3.5		8	
AFM42-100-Z07-A32R-OD04-C	100	32	50	3.5		7	
AFM42-100-Z08-A32R-OD04-C	100	32	50	3.5		8	
AFM42-125-Z08-A40R-OD04-C	125	40	63	3.5		8	
AFM42-125-Z10-A40R-OD04-C	125	40	63	3.5		10	

Dimension(mm)	Spare parts		
Cutter diameter	Screw	Wrench	Torque
φ 32-125			3.5Nm
	SP040112	DT-TP15	

Note: With internal coolant
 Without internal coolant



Product code	Dimension(mm)		Grades						
	Insert corner radius mm	Wiper length mm	AP301U	AP351U	AC301P	AP401U	AC301K	AP351K	AW100K
ODET 0404APFN-FM2	-	1.2							●
ODHT 0404APEN-MM3	-	1.2	●	●		●	●	●	
ODEW 0404APSR-HR2	-	1.2	●				●	●	
ODMW 040408EN-HR2	0.8	-					●		
ODMT 040408EN-MM3	0.8	-		●		●	●		

Marked : ● Stock available ○ Non-stocked standard

Materials				Cutting depth and feed								
ISO	Material classification	Tensile strength (N/mm ²)	Hardness (HB)	OD..0404								
				ap	Geometry							
					HR2		MM3		FM2			
					fz							
(mm)												
min		max		min		max		min		max		
P	Unalloyed steel	<600	<180	0.20	3.50	0.15	0.35	0.12	0.32	-	-	
		<950	<280									
	Alloyed steel	700-950	200-280			0.12	0.30	0.10	0.28	-	-	
		950-1200	280-355									
	1200-1400	355-415										
M	Duplex stainless steel	778	230									
	Austenitic stainless steel	675	200			-	-	0.08	0.25	-	-	
	Precipitation-hardening stainless steel	1013	300									
K	Grey cast iron	700	220									
	Nodular cast iron	880	260			0.15	0.35	0.12	0.32	-	-	
	Malleable cast iron	800	250									
S	Fe-based alloy	943	280									
	Co-based alloy	1076	320									
	Ni-based alloy	1177	350	-	-	-	-	-	-			
	Ti-alloy	1262	370									
N	Aluminum	260	75									
	Aluminum alloy	447	130	-	-	-	-	0.10	0.32			
H	Hardened steel	-	50-60HRC									
	Chilled cast iron	-	55HRC	0.08	0.20	-	-	-	-			

*The recommended cutting conditions always refer to general conditions. These cutting conditions should be adjusted according to the practical machine rigidity, tools, workpiece clamping and coolants. $f_z = \frac{h_m}{\sqrt{\frac{a_e}{D_c}}}$, (calculate for $\frac{a_e}{D_c} < 30\%$)



Milling cutters

AFM42-OD06

42 ° Approaching angle face milling cutter

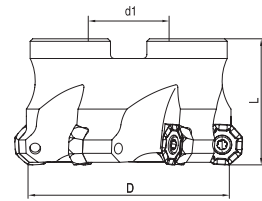
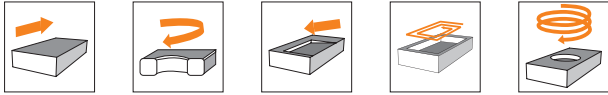

Product code	D	d1	L	apmax	Internal coolant	Z	Inserts
AFM42-050-Z04-A16R-OD06-C	50	16	40	4.5		4	OD..0605
AFM42-063-Z05-A22R-OD06-C	63	22	40	4.5		5	
AFM42-080-Z05-A27R-OD06-C	80	27	50	4.5		5	
AFM42-080-Z06-A27R-OD06-C	80	27	50	4.5		6	
AFM42-100-Z06-A32R-OD06-C	100	32	50	4.5		6	
AFM42-100-Z07-A32R-OD06-C	100	32	50	4.5		7	
AFM42-125-Z07-A40R-OD06-C	125	40	63	4.5		7	
AFM42-125-Z08-A40R-OD06-C	125	40	63	4.5		8	
AFM42-160-Z10-A40R-OD06	160	40	63	4.5		10	

Dimension(mm)	Spare parts		
	Screw	Wrench	Torque
φ 50-160			5.0Nm
	SP04512043	DT-TP20	

Note: With internal coolant
 Without internal coolant



Product code	Dimension(mm)		Grades						
	Insert corner radius mm	Wiper length mm	AP301U	AP351U	AC301P	AP401U	AC301K	AP351K	AW100K
ODET 0605APFN-FM2	-	1.6							●
ODMT 060508EN-MM3	0.8	-	●	●	●	●	●	●	
ODMT 060512EN-MM3	1.2	-	●						
ODHT 0605APEN-MM3	-	1.6	●	●		●	●		
ODEW 0605APSR-HR2	-	1.6					●	●	
ODEW 0605APSN-HR2	-	1.6					●	●	
ODMW 060512EN-HR2	1.2	-					●	●	

Marked : ● Stock available ○ Non-stocked standard

Materials				Cutting depth and feed								
ISO	Material classification	Tensile strength (N/mm ²)	Hardness (HB)	OD..0605								
				ap	Geometry						fz	
					HR2		MM3		FM2			
					(mm)							
min	max	min	max	min	max	min	max	min	max			
P	Unalloyed steel	<600	<180	0.20	4.50	0.15	0.40	0.12	0.35	-	-	
		<950	<280									
	Alloyed steel	700-950	200-280			0.12	0.35	0.10	0.30	-	-	
		950-1200	280-355									
	1200-1400	355-415										
M	Duplex stainless steel	778	230									
	Austenitic stainless steel	675	200			-	-	0.08	0.28	-	-	
	Precipitation-hardening stainless steel	1013	300									
K	Grey cast iron	700	220									
	Nodular cast iron	880	260			0.15	0.40	0.12	0.35	-	-	
	Malleable cast iron	800	250									
S	Fe-based alloy	943	280									
	Co-based alloy	1076	320									
	Ni-based alloy	1177	350	-	-	-	-	-	-			
	Ti-alloy	1262	370									
N	Aluminum	260	75									
	Aluminum alloy	447	130	-	-	-	-	0.10	0.35			
H	Hardened steel	-	50-60HRC									
	Chilled cast iron	-	55HRC	0.10	0.25	-	-	-	-			

*The recommended cutting conditions always refer to general conditions. These cutting conditions should be adjusted according to the practical machine rigidity, tools, workpiece clamping and coolants. $f_z = \frac{h_m}{\sqrt{\frac{a_e}{D_c}}}$, (calculate for $\frac{a_e}{D_c} < 30\%$)



Milling cutters

AFM40-ON05

40° Approaching angle face milling cutter

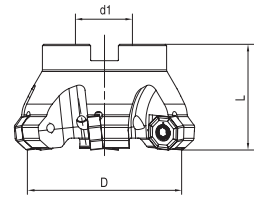
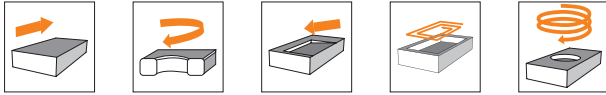

Product code	D	d1	L	apmax	Internal coolant	Z	Inserts
AFM40-050-Z04-A22R-ON05-N-C	50	22	40	3.5		4	ON..0504
AFM40-050-Z06-A22R-ON05-N-C	50	22	40	3.5		6	
AFM40-063-Z05-A22R-ON05-N-C	63	22	40	3.5		5	
AFM40-063-Z06-A22R-ON05-N-C	63	22	40	3.5		6	
AFM40-063-Z08-A22R-ON05-N-C	63	22	40	3.5		8	
AFM40-080-Z06-A27R-ON05-N-C	80	27	50	3.5		6	
AFM40-080-Z08-A27R-ON05-N-C	80	27	50	3.5		8	
AFM40-080-Z09-A27R-ON05-N-C	80	27	50	3.5		9	
AFM40-100-Z07-A32R-ON05-N-C	100	32	50	3.5		7	
AFM40-100-Z09-A32R-ON05-N-C	100	32	50	3.5		9	
AFM40-100-Z11-A32R-ON05-N-C	100	32	50	3.5		11	
AFM40-125-Z07-A40R-ON05-N-C	125	40	63	3.5		7	
AFM40-125-Z09-A40R-ON05-N-C	125	40	63	3.5		9	
AFM40-125-Z14-A40R-ON05-N-C	125	40	63	3.5		14	
AFM40-160-Z10-A40R-ON05-N	160	40	63	3.5		10	

Dimension(mm)	Spare parts		
Cutter diameter	Screw	Wrench	Torque
φ 50-160			4.0Nm
	SP040090	DT-TP15	

Note: With internal coolant
 Without internal coolant



Product code	Dimension(mm)		Grades						
	Insert corner radius mm	Wiper length mm	AP301U	AP351U	AC301P	AP401U	AC301K	AP351K	AW100K
ONHU 050408-MM3	0.8	-	●						
ONMU 050408-MM4	0.8	-	●	●		●	●	●	
ONHU 050408AEN-MM3	0.8	0.7	●	●				●	
ONHU 050408AEN-MM4	0.8	0.7		●				●	
ONHU 0504ZNR-MM3	0.8	1.4	●						

Marked : ● Stock available ○ Non-stocked standard

Milling cutters

Materials				Cutting depth and feed					
ISO	Material classification	Tensile strength (N/mm ²)	Hardness (HB)	ON..0504					
				ap	Geometry				
					MM3		MM4		
					fz				
				(mm)					
min	max	min	max	min	max				
P	Unalloyed steel	<600	<180	0.20	3.50	0.10	0.25	0.15	0.35
		<950	<280						
	Alloyed steel	700-950	200-280						
		950-1200	280-355						
M	Duplex stainless steel	778	230			0.08	0.20	0.10	0.25
	Austenitic stainless steel	675	200						
	Precipitation-hardening stainless steel	1013	300						
K	Grey cast iron	700	220			0.10	0.25	0.15	0.35
	Nodular cast iron	880	260						
	Malleable cast iron	800	250						
S	Fe-based alloy	943	280	-	-	-	-		
	Co-based alloy	1076	320						
	Ni-based alloy	1177	350						
	Ti-alloy	1262	370						
N	Aluminum	260	75	-	-	-	-		
	Aluminum alloy	447	130						
H	Hardened steel	-	50-60HRC	-	-	-	-		
	Chilled cast iron	-	55HRC						

*The recommended cutting conditions always refer to general conditions. These cutting conditions should be adjusted according to the practical machine rigidity, tools, workpiece clamping and coolants. $f_z = \frac{h_m}{\sqrt{\frac{a_e}{D_c}}}$, (calculate for $\frac{a_e}{D_c} < 30\%$)



P248

AFM45-SD09

45° Approaching angle face milling cutter

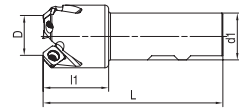
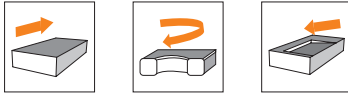

Product code	D	d1	L	l1	apmax	Internal coolant	Z	Inserts
AFM45-016-Z02-W16R-SD09-C	16	16	90	25	5		2	SD..09T3
AFM45-020-Z02-W20R-SD09-C	20	20	110	30	5		2	
AFM45-025-Z03-W25R-SD09-C	25	25	120	30	5		3	
AFM45-032-Z03-W32R-SD09-C	32	32	120	35	5		3	

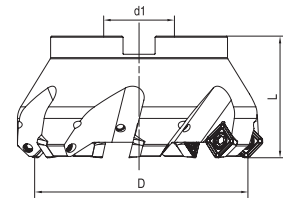

Product code	D	d1	L	l1	apmax	Internal coolant	Z	Inserts
AFM45-032-Z04-A16R-SD09-C	32	16	40	-	5		4	SD..09T3
AFM45-040-Z05-A16R-SD09-C	40	16	40	-	5		5	
AFM45-050-Z05-A22R-SD09-C	50	22	40	-	5		5	
AFM45-050-Z06-A22R-SD09-C	50	22	40	-	5		6	
AFM45-063-Z05-A22R-SD09-C	63	22	40	-	5		5	
AFM45-063-Z07-A22R-SD09-C	63	22	40	-	5		7	
AFM45-080-Z06-A27R-SD09-C	80	27	50	-	5		6	
AFM45-080-Z09-A27R-SD09-C	80	27	50	-	5		9	
AFM45-100-Z07-A32R-SD09-C	100	32	50	-	5		7	
AFM45-100-Z11-A32R-SD09-C	100	32	50	-	5		11	
AFM45-125-Z08-A40R-SD09-C	125	40	63	-	5		8	

Dimension(mm)	Spare parts		
	Screw	Wrench	Torque
φ 16-32			3.5Nm
	ST040075	DT-T15	
φ 40-125	SP040090	DT-TP15	

Note: With internal coolant
 Without internal coolant



Product code	Dimension(mm)		Grades						
	Insert corner radius mm	Wiper length mm	AP301U	AP351U	AC301P	AP401U	AC301K	AP351K	AW100K
SDMT 09T304EN-MM3	0.4	-	●	●	●		●		
SDMT 09T308EN-MM3	0.8	-	●	●	●		●		
SDGT 09T3AEEN-MM4	-	1.4	●	●			●	●	
SDMW 09T308EN-HR2	0.8	-	●				●		
SDHW 09T3AESN-HR2	-	1.5	●				●	●	

Marked : ● Stock available ○ Non-stocked standard

Milling cutters

Materials				Cutting depth and feed							
ISO	Material classification	Tensile strength (N/mm ²)	Hardness (HB)	SD..09T3..							
				ap	Geometry						
					HR2		MM3				
					fz						
(mm)											
min	max	min	max	min	max						
P	Unalloyed steel	<600	<180	0.20	5.00	0.10	0.35	0.08	0.30		
		<950	<280								
	Alloyed steel	700-950	200-280			0.08	0.30	0.05	0.28		
		950-1200	280-355								
		1200-1400	355-415								
M	Duplex stainless steel	778	230								
	Austenitic stainless steel	675	200			-	-	0.05	0.25		
	Precipitation-hardening stainless steel	1013	300								
K	Grey cast iron	700	220								
	Nodular cast iron	880	260			0.10	0.35	0.08	0.30		
	Malleable cast iron	800	250								
S	Fe-based alloy	943	280								
	Co-based alloy	1076	320								
	Ni-based alloy	1177	350	-	-	-	-				
	Ti-alloy	1262	370								
N	Aluminum	260	75								
	Aluminum alloy	447	130								
H	Hardened steel	-	50-60HRC								
	Chilled cast iron	-	55HRC	0.06	0.20	-	-				

*The recommended cutting conditions always refer to general conditions. These cutting conditions should be adjusted according to the practical machine rigidity, tools, workpiece clamping and coolants. $f_z = \frac{h_m}{\sqrt{\frac{a_e}{D_c}}}$, (calculate for $\frac{a_e}{D_c} < 30\%$)



P248

AFM75-SD09

75° Approach angle milling face cutter

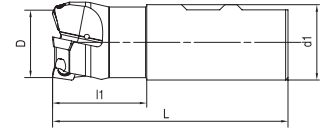
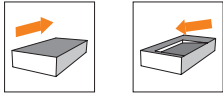

Product code	D	d1	L	l1	apmax	Internal coolant	Z	Inserts
AFM75-025-Z02-W25R-SD09-C	25	25	96	40	6		2	SD..09T3
AFM75-032-Z03-W32R-SD09-C	32	32	100	40	6		3	

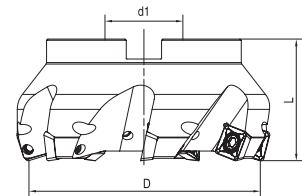

Product code	D	d1	L	l1	apmax	Internal coolant	Z	Inserts
AFM75-040-Z04-A16R-SD09-C	40	16	32	-	6		4	SD..09T3
AFM75-050-Z05-A22R-SD09-C	50	22	40	-	6		5	
AFM75-063-Z06-A22R-SD09-C	63	22	40	-	6		6	
AFM75-080-Z08-A27R-SD09-C	80	27	50	-	6		8	
AFM75-100-Z10-A32R-SD09-C	100	32	50	-	6		10	

Dimension(mm)	Spare parts		
	Screw	Wrench	Torque
φ 25-32			3.5Nm
	ST040075	DT-T15	
φ 40-100	SP040090	DT-TP15	

Note: With internal coolant
 Without internal coolant



Product code	Dimension(mm)		Grades						
	Insert corner radius mm	Wiper length mm	AP301U	AP351U	AC301P	AP401U	AC301K	AP351K	AW100K
SDMT 09T304EN-MM3	0.4	-	●	●	●		●		
SDMT 09T308EN-MM3	0.8	-	●	●	●		●		
SDMW 09T308EN-HR2	0.8	-	●				●		

Marked : ● Stock available ○ Non-stocked standard

Milling cutters

Materials				Cutting depth and feed							
ISO	Material classification	Tensile strength (N/mm ²)	Hardness (HB)	SD..09T3..							
				ap	Geometry						
					HR2		MM3				
					fz						
(mm)											
min	max	min	max	min	max						
P	Unalloyed steel	<600	<180	0.20	6.00	0.10	0.35	0.08	0.30		
		<950	<280								
	Alloyed steel	700-950	200-280			0.08	0.30	0.05	0.28		
		950-1200	280-355								
		1200-1400	355-415								
M	Duplex stainless steel	778	230								
	Austenitic stainless steel	675	200			-	-	0.05	0.25		
	Precipitation-hardening stainless steel	1013	300								
K	Grey cast iron	700	220								
	Nodular cast iron	880	260			0.10	0.35	0.08	0.30		
	Malleable cast iron	800	250								
S	Fe-based alloy	943	280								
	Co-based alloy	1076	320								
	Ni-based alloy	1177	350	-	-	-	-				
	Ti-alloy	1262	370								
N	Aluminum	260	75								
	Aluminum alloy	447	130								
H	Hardened steel	-	50-60HRC								
	Chilled cast iron	-	55HRC	0.06	0.20	-	-				

*The recommended cutting conditions always refer to general conditions. These cutting conditions should be adjusted according to the practical machine rigidity, tools, workpiece clamping and coolants. $f_z = \frac{h_m}{\sqrt{\frac{a_e}{D_c}}}$, (calculate for $\frac{a_e}{D_c} < 30\%$)



P248

AFM90-SD09

90° Approach angle face milling cutter

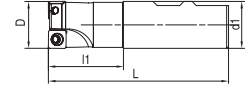
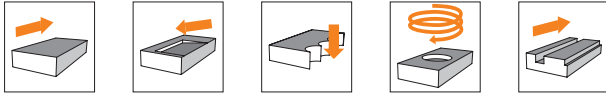

Product code	D	d1	L	l1	apmax	Internal coolant	Z	Inserts
AFM90-025-Z02-W25R-SD09-C	25	25	120	30	6		2	SD..09T3
AFM90-032-Z03-W32R-SD09-C	32	32	120	35	6		3	

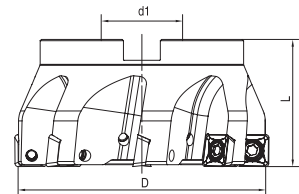

Product code	D	d1	L	l1	apmax	Internal coolant	Z	Inserts
AFM90-040-Z04-A16R-SD09-C	40	16	40	-	6		4	SD..09T3
AFM90-050-Z05-A22R-SD09-C	50	22	40	-	6		5	
AFM90-063-Z06-A22R-SD09-C	63	22	40	-	6		6	
AFM90-080-Z08-A27R-SD09-C	80	27	50	-	6		8	
AFM90-100-Z10-A32R-SD09-C	100	32	50	-	6		10	

Dimension(mm)	Spare parts		
	Screw	Wrench	Torque
φ 25-32			3.5Nm
	ST040075	DT-T15	
φ 40-100	SP040090	DT-TP15	

Note: With internal coolant
 Without internal coolant



Product code	Dimension(mm)		Grades						
	Insert corner radius mm	Wiper length mm	AP301U	AP351U	AC301P	AP401U	AC301K	AP351K	AW100K
SDMT 09T304EN-MM3	0.4	-	●	●	●		●		
SDMT 09T308EN-MM3	0.8	-	●	●	●		●		
SDGT 09T3PDER-MR6	0.8	1.2	●	●			●	●	
SDMW 09T308EN-HR2	0.8	-	●				●		

Marked : ● Stock available ○ Non-stocked standard

Materials				Cutting depth and feed							
ISO	Material classification	Tensile strength (N/mm ²)	Hardness (HB)	SD..09T3..							
				ap	Geometry						
					HR2		MM3				
				fz							
(mm)											
min	max	min	max	min	max						
P	Unalloyed steel	<600	<180	0.20	6.00	0.10	0.35	0.08	0.30		
		<950	<280								
	Alloyed steel	700-950	200-280			0.08	0.30	0.05	0.28		
		950-1200	280-355								
	1200-1400	355-415									
M	Duplex stainless steel	778	230								
	Austenitic stainless steel	675	200			-	-	0.05	0.25		
	Precipitation-hardening stainless steel	1013	300								
K	Grey cast iron	700	220								
	Nodular cast iron	880	260			0.10	0.35	0.08	0.30		
	Malleable cast iron	800	250								
S	Fe-based alloy	943	280								
	Co-based alloy	1076	320								
	Ni-based alloy	1177	350								
	Ti-alloy	1262	370								
N	Aluminum	260	75								
	Aluminum alloy	447	130								
H	Hardened steel	-	50-60HRC								
	Chilled cast iron	-	55HRC	0.06	0.20	-	-				

*The recommended cutting conditions always refer to general conditions. These cutting conditions should be adjusted according to the practical machine rigidity, tools, workpiece clamping and coolants. $f_z = \frac{h_m}{\sqrt{\frac{a_e}{D_c}}}$, (calculate for $\frac{a_e}{D_c} < 30\%$)



Milling cutters

AFM45-SD12

45° Approach angle face milling cutter

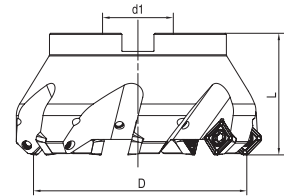
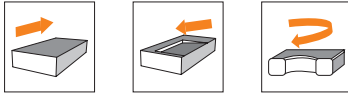

Product code	D	d1	L	l1	apmax	Internal coolant	Z	Inserts
AFM45-050-Z04-A22R-SD12-C	50	22	40	-	7		4	SD..1204
AFM45-063-Z05-A22R-SD12-C	63	22	40	-	7		5	
AFM45-080-Z06-A27R-SD12-C	80	27	50	-	7		6	
AFM45-100-Z07-A32R-SD12-C	100	32	50	-	7		7	
AFM45-125-Z08-A40R-SD12-C	125	40	63	-	7		8	

Dimension(mm)	Spare parts		
Cutter diameter	Screw	Wrench	Torque
φ 50-125			5.0Nm
	SP04511555	DT-TP20	

Note: With internal coolant
 Without internal coolant



Product code	Dimension(mm)		Grades						
	Insert corner radius mm	Wiper length mm	AP301U	AP351U	AC301P	AP401U	AC301K	AP351K	AW100K
SDMT 120408EN-MM4	0.8	-	●	●			●	●	
SDMT 120412EN-MM3	1.2	-	●	●	●		●		
SDKT 1204AEEN-MR2	-	1.5	●	●	●		●	●	
SDHT 1204AEEN-MR6	-	1.5	●	●			●	●	
SDMW 120412EN-HR2	1.2	-	●				●	●	
SDHW 1204AESN-HR2	-	2	●				●	●	

Marked : ● Stock available ○ Non-stocked standard

Materials				Cutting depth and feed									
ISO	Material classification	Tensile strength (N/mm ²)	Hardness (HB)	SD..1204..									
				ap	Geometry				fz				
					HR2	MR2	MR6	MM3	(mm)				
				min	max	min	max	min	max	min	max	min	max
P	Unalloyed steel	<600	<180	0.20	7.00	0.20	0.40	0.15	0.30	0.15	0.35	0.12	0.28
		<950	<280			0.20	0.35	0.15	0.25	0.15	0.30	0.10	0.25
	Alloyed steel	700-950	200-280			-	-	0.12	0.25	-	-	0.08	0.20
		950-1200	280-355			0.15	0.30	0.10	0.22	0.15	0.30	0.12	0.28
M	Duplex stainless steel	778	230	0.20	7.00	-	-	-	-	-	-	-	-
	Austenitic stainless steel	675	200			-	-	-	-	-	-	-	-
	Precipitation-hardening stainless steel	1013	300			-	-	-	-	-	-	-	-
K	Grey cast iron	700	220	0.20	7.00	0.15	0.30	0.10	0.22	0.15	0.30	0.12	0.28
	Nodular cast iron	880	260			-	-	-	-	-	-	-	-
	Malleable cast iron	800	250			-	-	-	-	-	-	-	-
S	Fe-based alloy	943	280	0.20	7.00	-	-	-	-	-	-	0.08	0.20
	Co-based alloy	1076	320			-	-	-	-	-	-	-	-
	Ni-based alloy	1177	350			-	-	-	-	-	-	-	-
	Ti-alloy	1262	370			-	-	-	-	-	-	-	-
N	Aluminum	260	75	0.20	7.00	-	-	-	-	-	-	-	-
	Aluminum alloy	447	130			-	-	-	-	-	-	-	-
H	Hardened steel	-	50-60HRC	0.20	7.00	0.08	0.25	-	-	-	-	-	-
	Chilled cast iron	-	55HRC			-	-	-	-	-	-	-	-

*The recommended cutting conditions always refer to general conditions. These cutting conditions should be adjusted according to the practical machine rigidity, tools, workpiece clamping and coolants. $f_z = \frac{h_m}{\sqrt{\frac{a_e}{D_c}}}$, (calculate for $\frac{a_e}{D_c} < 30\%$)



Milling cutters

AFM75-SD12

75° Approach angle face milling cutter

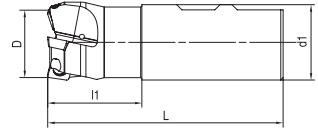
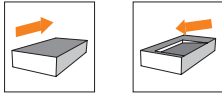

Product code	D	d1	L	l1	apmax	Internal coolant	Z	Inserts
AFM75-032-Z02-W32R-SD12-C	32	32	114	49	8		2	SD..1204
AFM75-040-Z03-W32R-SD12-C	40	32	114	49	8		3	

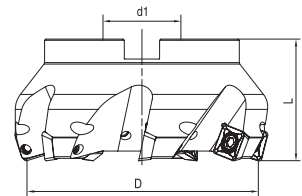

Product code	D	d1	L	l1	apmax	Internal coolant	Z	Inserts
AFM75-050-Z04-A22R-SD12-C	50	22	40	-	8		4	SD..1204
AFM75-063-Z05-A22R-SD12-C	63	22	40	-	8		5	
AFM75-080-Z06-A27R-SD12-C	80	27	50	-	8		6	
AFM75-100-Z07-A32R-SD12-C	100	32	50	-	8		7	
AFM75-125-Z08-A40R-SD12-C	125	40	63	-	8		8	

Dimension(mm)	Spare parts		
	Screw	Wrench	Torque
φ 32-125			5.0Nm
	SP04511555	DT-TP20	

Note: With internal coolant
 Without internal coolant



Product code	Dimension(mm)		Grades						
	Insert corner radius mm	Wiper length mm	AP301U	AP351U	AC301P	AP401U	AC301K	AP351K	AW100K
SDMT 120408EN-MM4	0.8	-	●	●			●	●	
SDMT 120412EN-MM3	1.2	-	●	●	●		●		
SDMW 120412EN-HR2	1.2	-	●				●	●	

Marked : ● Stock available ○ Non-stocked standard

Milling cutters

Materials				Cutting depth and feed							
ISO	Material classification	Tensile strength (N/mm ²)	Hardness (HB)	SD..1204..							
				ap	Geometry						
					HR2		MM3				
				fz							
(mm)											
min	max	min	max	min	max	min	max				
P	Unalloyed steel	<600	<180	0.20	8.00	0.15	0.35	0.12	0.30		
		<950	<280								
	Alloyed steel	700-950	200-280			0.12	0.30	0.10	0.25		
		950-1200	280-355								
	1200-1400	355-415									
M	Duplex stainless steel	778	230								
	Austenitic stainless steel	675	200			-	-	0.10	0.22		
	Precipitation-hardening stainless steel	1013	300								
K	Grey cast iron	700	220					0.15	0.35	0.12	0.30
	Nodular cast iron	880	260								
	Malleable cast iron	800	250								
S	Fe-based alloy	943	280					0.10	0.20		
	Co-based alloy	1076	320								
	Ni-based alloy	1177	350								
	Ti-alloy	1262	370								
N	Aluminum	260	75								
	Aluminum alloy	447	130								
H	Hardened steel	-	50-60HRC			0.08	0.25	-	-		
	Chilled cast iron	-	55HRC								

*The recommended cutting conditions always refer to general conditions. These cutting conditions should be adjusted according to the practical machine rigidity, tools, workpiece clamping and coolants. $f_z = \frac{h_m}{\sqrt{\frac{a_e}{D_c}}}$, (calculate for $\frac{a_e}{D_c} < 30\%$)



AFM90-SD12

90° Approach angle face milling cutter

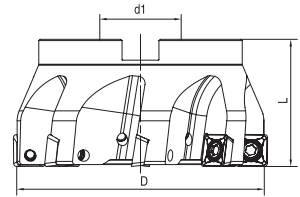
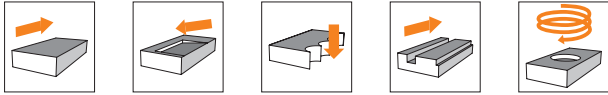

Product code	D	d1	L	l1	apmax	Internal coolant	Z	Inserts
AFM90-050-Z04-A22R-SD12-C	50	22	40	-	9		4	SD..1204
AFM90-063-Z05-A22R-SD12-C	63	22	40	-	9		5	
AFM90-080-Z06-A27R-SD12-C	80	27	50	-	9		6	
AFM90-100-Z08-A32R-SD12-C	100	32	50	-	9		8	
AFM90-125-Z10-A40R-SD12-C	125	40	63	-	9		10	

Dimension(mm)	Spare parts		
Cutter diameter	Screw	Wrench	Torque
φ 50-125			5.0Nm
	SP04511555	DT-TP20	

Note: With internal coolant
 Without internal coolant



Product code	Dimension(mm)		Grades						
	Insert corner radius mm	Wiper length mm	AP301U	AP351U	AC301P	AP401U	AC301K	AP351K	AW100K
SDMT 120408EN-MM4	0.8	-	●	●			●	●	
SDMT 120412EN-MM3	1.2	-	●	●	●		●		
SDGT 1204PDER-MR6	0.8	1.6	●	●			●	●	
SDMW 120412EN-HR2	1.2	-	●				●	●	

Marked : ● Stock available ○ Non-stocked standard

Materials				Cutting depth and feed							
ISO	Material classification	Tensile strength (N/mm ²)	Hardness (HB)	SD..1204..							
				ap	Geometry						
					HR2		MM3				
				fz							
(mm)											
min	max	min	max	min	max	min	max				
P	Unalloyed steel	<600	<180	0.20	9.00	0.15	0.35	0.12	0.30		
		<950	<280								
	Alloyed steel	700-950	200-280			0.12	0.30	0.10	0.25		
		950-1200	280-355								
	1200-1400	355-415									
M	Duplex stainless steel	778	230								
	Austenitic stainless steel	675	200			-	-	0.10	0.22		
	Precipitation-hardening stainless steel	1013	300								
K	Grey cast iron	700	220					0.15	0.35	0.12	0.30
	Nodular cast iron	880	260								
	Malleable cast iron	800	250								
S	Fe-based alloy	943	280					0.10	0.20		
	Co-based alloy	1076	320								
	Ni-based alloy	1177	350								
	Ti-alloy	1262	370								
N	Aluminum	260	75								
	Aluminum alloy	447	130								
H	Hardened steel	-	50-60HRC			0.08	0.25	-	-		
	Chilled cast iron	-	55HRC								

*The recommended cutting conditions always refer to general conditions. These cutting conditions should be adjusted according to the practical machine rigidity, tools, workpiece clamping and coolants. $f_z = \frac{h_m}{\sqrt{\frac{a_e}{D_c}}}$, (calculate for $\frac{a_e}{D_c} < 30\%$)



Milling cutters

AFM45-SN12/SN19
45° Approach angle face milling cutter

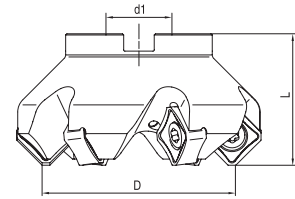

Product code	D	d1	L	apmax	Internal coolant	Z	Inserts
AFM45-050-Z04-A22R-SN12-N-C	50	22	40	6.5		4	SN □ X 1206ANN SN □ X1206..
AFM45-050-Z06-A22R-SN12-N-C	50	22	40	6.5		6	
AFM45-063-Z04-A22R-SN12-N-C	63	22	40	6.5		4	
AFM45-063-Z06-A22R-SN12-N-C	63	22	40	6.5		6	
AFM45-063-Z08-A22R-SN12-N-C	63	22	40	6.5		8	
AFM45-080-Z04-A27R-SN12-N-C	80	27	50	6.5		4	
AFM45-080-Z05-A27R-SN12-N-C	80	27	50	6.5		5	
AFM45-080-Z07-A27R-SN12-N-C	80	27	50	6.5		7	
AFM45-100-Z06-A32R-SN12-N-C	100	32	50	6.5		6	
AFM45-100-Z08-A32R-SN12-N-C	100	32	50	6.5		8	
AFM45-125-Z07-A40R-SN12-N-C	125	40	63	6.5		7	
AFM45-125-Z08-A40R-SN12-N-C	125	40	63	6.5		8	
AFM45-125-Z10-A40R-SN12-N-C	125	40	63	6.5		10	
AFM45-160-Z10-A40R-SN12-N	160	40	63	6.5		10	
AFM45-200-Z14-A60R-SN12-N	200	60	63	6.5		14	
AFM45-250-Z16-A60R-SN12-N	250	60	63	6.5		16	
AFM45-160-Z08-A40R-SN19	160	40	63	11		8	SN □ X1909ANN
AFM45-200-Z10-A60R-SN19	200	60	63	11		10	
AFM45-250-Z12-A60R-SN19	250	60	63	11		12	

Dimension(mm)	Spare parts		
Cutter diameter	Screw	Wrench	Torque
φ 50-250(SN..1206ANN)			
	SP050120	DT-TP20	3.5Nm
φ 160-250(SN..1909ANN)	SP06018070	DT-TP25	5.0Nm

Note: With internal coolant
 Without internal coolant



Product code	Dimension(mm)		Grades						
	Insert corner radius mm	Wiper length mm	AP301U	AP351U	AC301P	AP401U	AC301K	AP351K	AW100K
SNGX 1206ANN-MM3	-	1.8	●	●	●		●	●	
SNGX 1206ANN-MM4	-	1.8	●	●	●		●	●	
SNGX 1206ANN-MR6	-	1.8	●	●	●		●	●	
SNGX 1206ANN-RR2	-	1.8	●	●	●		●	●	
SNGX 1909ANN-MM3	-	2.9	●	●					
SNGX 1909ANN-MR6	-	2.9		●					
SNGX 120608-MM4	0.8	-	●	●	●		●	●	
SNGX 120612-MM4	1.2	-	●						
SNMX 1206ANN-MM3	-	1.8	●	●	●		●	●	
SNMX 1206ANN-MM4	-	1.8	●	●	●		●	●	
SNMX 1206ANN-MR6	-	1.8	●	●	●		●	●	
SNMX 120608-MM4	0.8	-	●	●	●		●	●	
SNMX 120612-MM3	1.2	-	●	●	●		●	●	
SNMX 120612-MM4	1.2	-	●	●	●		●	●	
SNMX 120612-MR6	1.2	-	●	●	●		●	●	
SNMX 120612-RR2	1.2	-	●	●	●		●	●	
SNMX 120620-MM4	2.0	-	●	●	●		●	●	
SNMX 120620-RR2	2.0	-	●	●	●		●	●	●
SNHX 1206ANN-FM2	-	1.8							
SNHX 1206ANN-W	-	6.7	●				●		

Marked : ● Stock available ○ Non-stocked standard

Milling cutters

Materials				Cutting depth and feed											
ISO	Material classification	Tensile strength (N/mm ²)	Hardness (HB)	SNGX 1206..											
				ap	Geometry					fz					
					MM3		MM4		MR6		RR2		FM2		
					(mm)										
min	max	min	max	min	max	min	max	min	max	min	max				
P	Unalloyed steel	<600	<180	0.20	6.50	0.15	0.35	0.18	0.38	0.18	0.40	0.18	0.45	-	-
		<950	<280												
	Alloyed steel	700-950	200-280			0.12	0.32	0.15	0.35	0.15	0.38	0.15	0.38	-	-
		950-1200	280-355												
M	Duplex stainless steel	778	230			0.12	0.30	0.12	0.32	-	-	-	-	-	-
	Austenitic stainless steel	675	200												
	Precipitation-hardening stainless steel	1013	300												
K	Grey cast iron	700	220			0.15	0.35	0.18	0.38	0.18	0.40	0.18	0.45	-	-
	Nodular cast iron	880	260												
	Malleable cast iron	800	250												
S	Fe-based alloy	943	280			0.10	0.25	0.12	0.28	-	-	-	-	-	-
	Co-based alloy	1076	320												
	Ni-based alloy	1177	350												
	Ti-alloy	1262	370												
N	Aluminum	260	75	-	-	-	-	-	-	-	-	0.15	0.35		
	Aluminum alloy	447	130												
H	Hardened steel	-	50-60HRC	-	-	-	-	-	-	-	-	-	-		
	Chilled cast iron	-	55HRC												

*The recommended cutting conditions always refer to general conditions. These cutting conditions should be adjusted according to the practical machine rigidity, tools, workpiece clamping and coolants. $f_z = \frac{h_m}{\sqrt{\frac{a_e}{D_c}}}$, (calculate for $\frac{a_e}{D_c} < 30\%$)



AFM75-SN12

75° Approach angle face milling cutter

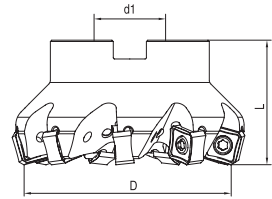

Product code	D	d1	L	apmax	Internal coolant	Z	Inserts
AFM75-050-Z04-A22R-SN12-N-C	50	22	40	8.0		4	SNGX1206ENN SN □ X1206..
AFM75-063-Z06-A22R-SN12-N-C	63	22	40	8.0		6	
AFM75-080-Z07-A27R-SN12-N-C	80	27	50	8.0		7	
AFM75-100-Z08-A32R-SN12-N-C	100	32	50	8.0		8	
AFM75-125-Z08-A40R-SN12-N-C	125	40	63	8.0		8	
AFM75-125-Z10-A40R-SN12-N-C	125	40	63	8.0		10	
AFM75-160-Z10-A40R-SN12-N	160	40	63	8.0		10	
AFM75-200-Z14-A60R-SN12-N	200	60	63	8.0		16	
AFM75-250-Z16-A60R-SN12-N	250	60	63	8.0		16	

Dimension(mm)	Spare parts		
Cutter diameter	Screw	Wrench	Torque
φ 50-250			3.5Nm
	SP050120	DT-TP20	

Note: With internal coolant
 Without internal coolant



Product code	Dimension(mm)		Grades						
	Insert corner radius mm	Wiper length mm	AP301U	AP351U	AC301P	AP401U	AC301K	AP351K	AW100K
SNGX 1206ENN-MM3	-	1.2	●	●	●		●	●	
SNGX 1206ENN-MM4	-	1.2	●	●	●		●	●	
SNGX 1206ENN-MR6	-	1.2	●	●	●		●	●	
SNGX 120608-MM4	0.8	-	●	●	●		●	●	
SNGX 120612-MM4	1.2	-	●						
SNMX 1206ENN-MM4	-	1.2			●				
SNMX 120608-MM4	0.8	-	●	●	●		●	●	
SNMX 120612-MM3	1.2	-	●	●	●		●	●	
SNMX 120612-MM4	1.2	-	●	●	●		●	●	
SNMX 120612-MR6	1.2	-	●	●	●		●	●	
SNMX 120612-RR2	1.2	-	●	●	●		●	●	
SNMX 120620-MM4	2.0	-	●	●	●		●	●	
SNMX 120620-RR2	2.0	-	●	●	●		●	●	

Marked : ● Stock available ○ Non-stocked standard

Materials				Cutting depth and feed											
ISO	Material classification	Tensile strength (N/mm ²)	Hardness (HB)	SNGX 1206..											
				ap	Geometry				fz						
					MM3		MM4		MR6		RR2				
					(mm)										
min	max	min	max	min	max	min	max	min	max						
P	Unalloyed steel	<600	<180	0.20	8.00	0.12	0.32	0.19	0.35	0.15	0.38	0.18	0.40		
		<950	<280												
	Alloyed steel	700-950	200-280			0.10	0.30	0.12	0.32	0.10	0.35	0.15	0.35		
		950-1200	280-355												
	1200-1400	355-415													
M	Duplex stainless steel	778	230												
	Austenitic stainless steel	675	200			0.10	0.28	0.10	0.30	-	-	-	-	-	-
	Precipitation-hardening stainless steel	1013	300												
K	Grey cast iron	700	220												
	Nodular cast iron	880	260			0.12	0.32	0.15	0.35	0.12	0.35	0.18	0.40		
	Malleable cast iron	800	250												
S	Fe-based alloy	943	280												
	Co-based alloy	1076	320												
	Ni-based alloy	1177	350	0.10	0.22	0.10	0.25	-	-	-	-	-	-		
	Ti-alloy	1262	370												
N	Aluminum	260	75												
	Aluminum alloy	447	130												
H	Hardened steel	-	50-60HRC												
	Chilled cast iron	-	55HRC												

*The recommended cutting conditions always refer to general conditions. These cutting conditions should be adjusted according to the practical machine rigidity, tools, workpiece clamping and coolants. $f_z = \frac{h_m}{\sqrt{\frac{a_e}{D_c}}}$, (calculate for $\frac{a_e}{D_c} < 30\%$)



Milling cutters

AFM88-SN12

88° Approach angle face milling cutter

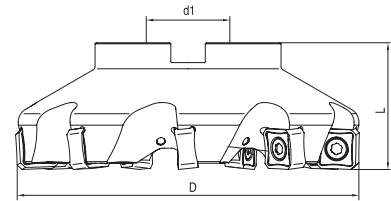

Product code	D	d1	L	apmax	Internal coolant	Z	Inserts
AFM88-050-Z04-A22R-SN12-N-C	50	22	40	10.0		4	SNGX1206ZNN SN □ X1206..
AFM88-063-Z04-A22R-SN12-N-C	63	22	40	10.0		4	
AFM88-063-Z06-A22R-SN12-N-C	63	22	40	10.0		6	
AFM88-080-Z04-A27R-SN12-N-C	80	27	50	10.0		4	
AFM88-080-Z07-A27R-SN12-N-C	80	27	50	10.0		7	
AFM88-100-Z08-A32R-SN12-N-C	100	32	50	10.0		8	
AFM88-100-Z11-A32R-SN12-N-C	100	32	50	10.0		11	
AFM88-125-Z10-A40R-SN12-N-C	125	40	63	10.0		10	
AFM88-125-Z13-A40R-SN12-N-C	125	40	63	10.0		13	
AFM88-160-Z12-A40R-SN12-N	160	40	63	10.0		12	
AFM88-200-Z14-A60R-SN12-N	200	60	63	10.0		14	

Dimension(mm)	Spare parts		
Cutter diameter	Screw	Wrench	Torque
φ 50-200			3.5Nm
	SP050120	DT-TP20	

Note: With internal coolant
 Without internal coolant



Product code	Dimension(mm)		Grades						
	Insert corner radius mm	Wiper length mm	AP301U	AP351U	AC301P	AP401U	AC301K	AP351K	AW100K
SNGX 1206ZNN-MM3	-	1.2	●	●	●		●	●	
SNGX 1206ZNN-MM4	-	1.2	●	●	●		●	●	
SNGX 1206ZNN-MR6	-	1.2	●	●	●		●	●	
SNGX 120608-MM4	0.8	-	●	●	●		●	●	
SNGX 120612-MM4	1.2	-	●						
SNMX 120608-MM4	0.8	-	●	●	●		●	●	
SNMX 120612-MM3	1.2	-	●	●	●		●	●	
SNMX 120612-MM4	1.2	-	●	●	●		●	●	
SNMX 120612-MR6	1.2	-	●	●	●		●	●	
SNMX 120612-RR2	1.2	-	●	●	●		●	●	
SNMX 120620-MM4	2.0	-	●	●	●		●	●	
SNMX 120620-RR2	2.0	-	●	●	●		●	●	
SNHX 1206ZNN-FM2	-	1.2							●
SNHX 1206ZNN-W	1.0	4.4	●				●		

Marked : ● Stock available ○ Non-stocked standard

Materials				Cutting depth and feed												
ISO	Material classification	Tensile strength (N/mm ²)	Hardness (HB)	SNGX 1206..												
				ap	Geometry					fz						
					MM3		MM4		MR6		RR2		FM2			
					(mm)											
min	max	min	max	min	max	min	max	min	max	min	max					
P	Unalloyed steel	<600	<180	0.20	10.00	0.12	0.32	0.19	0.35	0.15	0.38	0.18	0.40	-	-	
		<950	<280													
	Alloyed steel	700-950	200-280			0.10	0.30	0.12	0.32	0.10	0.35	0.15	0.35	-	-	
		950-1200	280-355													
	1200-1400	355-415														
M	Duplex stainless steel	778	230													
	Austenitic stainless steel	675	200			0.10	0.28	0.10	0.30	-	-	-	-	-	-	
	Precipitation-hardening stainless steel	1013	300													
K	Grey cast iron	700	220													
	Nodular cast iron	880	260			0.12	0.32	0.15	0.35	0.12	0.35	0.18	0.40	-	-	
	Malleable cast iron	800	250													
S	Fe-based alloy	943	280													
	Co-based alloy	1076	320													
	Ni-based alloy	1177	350	0.10	0.22	0.10	0.25	-	-	-	-	-	-			
	Ti-alloy	1262	370													
N	Aluminum	260	75													
	Aluminum alloy	447	130	-	-	-	-	-	-	-	-	0.12	0.32			
H	Hardened steel	-	50-60HRC													
	Chilled cast iron	-	55HRC	-	-	-	-	-	-	-	-	-	-			

*The recommended cutting conditions always refer to general conditions. These cutting conditions should be adjusted according to the practical machine rigidity, tools, workpiece clamping and coolants. $f_z = \frac{h_m}{\sqrt{\frac{a_e}{D_c}}}$, (calculate for $\frac{a_e}{D_c} < 30\%$)



Milling cutters

AFM45-XN07

45° Approach angle face milling cutter

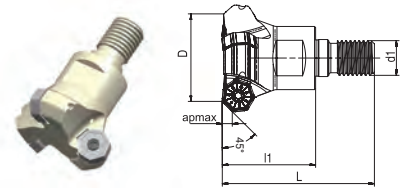

Product code	D	d1	L	l1	apmax	Internal coolant	Z	Inserts
AFM45-040-Z03-M16R-XN07-C	40	16	70	43	4.4		3	XN..U 0705

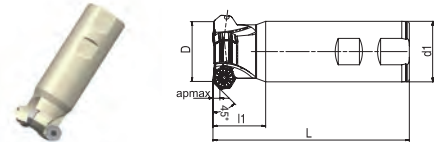

Product code	D	d1	L	l1	apmax	Internal coolant	Z	Inserts
AFM45-040-Z03-W40R-XN07-C	40	40	130	35	4.4		3	XN..U 0705

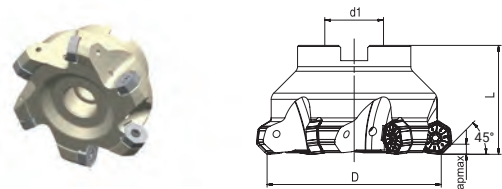

Product code	D	d1	L	l1	apmax	Internal coolant	Z	Inserts
AFM45-040-Z03-A16R-XN07-C	40	16	40	-	4.4		3	XN..U 0705
AFM45-050-Z04-A22R-XN07-C	50	22	40	-	4.4		4	
AFM45-050-Z05-A22R-XN07-C	50	22	40	-	4.4		5	
AFM45-063-Z05-A22R-XN07-C	63	22	40	-	4.4		5	
AFM45-063-Z06-A22R-XN07-C	63	22	40	-	4.4		6	
AFM45-080-Z06-A27R-XN07-C	80	27	50	-	4.4		6	
AFM45-080-Z07-A27R-XN07-C	80	27	50	-	4.4		7	
AFM45-100-Z07-A32R-XN07-C	100	32	50	-	4.4		7	
AFM45-100-Z08-A32R-XN07-C	100	32	50	-	4.4		8	
AFM45-125-Z08-A40R-XN07-C	125	40	63	-	4.4		8	
AFM45-125-Z10-A40R-XN07-C	125	40	63	-	4.4		10	
AFM45-160-Z09-A40R-XN07	160	40	63	-	4.4		9	
AFM45-160-Z12-A40R-XN07	160	40	63	-	4.4		12	

Dimension(mm)	Spare parts		
	Screw	Wrench	Torque
φ 40-160			3.5Nm
	SP035120H	DT-TP15	

Note: With internal coolant
 Without internal coolant



Product code	Dimension(mm)		Grades						
	Insert corner radius mm	Wiper length mm	AP301U	AP351U	AC301P	AP401U	AC301K	AP351K	AW100K
XNGU 0705ANN-MM3	0.8	1.1	●	●		●	●		
XNGU 0705ANN-MM4	0.8	1.1	●				●		
XNMU 0705ANN-MM4	0.8	1.1	●	●	●	●	●	●	
XNMU 0705ANN-MR6	0.8	1.1	●	●		●	●	●	
XNMU 070508-MM4	0.8	-		●		●	●	●	
XNGX 0705ANN-W	1.0	6	●				●		

Marked : ● Stock available ○ Non-stocked standard

Milling cutters

Materials				Cutting depth and feed							
ISO	Material classification	Tensile strength (N/mm ²)	Hardness (HB)	XN.. 0705..							
				ap	Geometry						
					MM3		MM4		MR6		
				fz							
(mm)											
min	max	min	max	min	max	min	max	min	max		
P	Unalloyed steel	<600	<180	0.20	4.40	0.15	0.35	0.18	0.38	0.18	0.40
		<950	<280								
	Alloyed steel	700-950	200-280			0.12	0.32	0.15	0.35	0.15	0.38
		950-1200	280-355								
	1200-1400	355-415									
M	Duplex stainless steel	778	230								
	Austenitic stainless steel	675	200			0.12	0.30	0.12	0.32	-	-
	Precipitation-hardening stainless steel	1013	300								
K	Grey cast iron	700	220								
	Nodular cast iron	880	260			0.15	0.35	0.18	0.38	0.18	0.40
	Malleable cast iron	800	250								
S	Fe-based alloy	943	280								
	Co-based alloy	1076	320								
	Ni-based alloy	1177	350	0.10	0.25	0.12	0.28	-	-		
	Ti-alloy	1262	370								
N	Aluminum	260	75								
	Aluminum alloy	447	130								
H	Hardened steel	-	50-60HRC								
	Chilled cast iron	-	55HRC								

*The recommended cutting conditions always refer to general conditions. These cutting conditions should be adjusted according to the practical machine rigidity, tools, workpiece clamping and coolants. $f_z = \frac{h_m}{\sqrt{\frac{a_e}{D_c}}}$, (calculate for $\frac{a_e}{D_c} < 30\%$)



AFM45-XN09
45° Approach angle face milling cutter

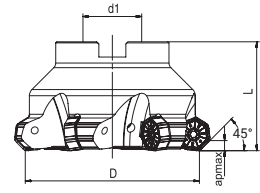

Product code	D	d1	L	l1	apmax	Internal coolant	Z	Inserts
AFM45-063-Z05-A22R-XN09-C	63	22	40	-	6.0		5	XN..U 0906
AFM45-080-Z06-A27R-XN09-C	80	27	50	-	6.0		6	
AFM45-100-Z07-A32R-XN09-C	100	32	50	-	6.0		7	
AFM45-100-Z08-A32R-XN09-C	100	32	50	-	6.0		8	
AFM45-125-Z08-A40R-XN09-C	125	40	63	-	6.0		8	
AFM45-125-Z10-A40R-XN09-C	125	40	63	-	6.0		10	
AFM45-160-Z09-A40R-XN09	160	40	63	-	6.0		9	
AFM45-160-Z11-A40R-XN09	200	60	63	-	6.0		11	
AFM45-200-Z12-A60R-XN09	200	60	63	-	6.0		12	

Dimension(mm)	Spare parts		
Cutter diameter	Screw	Wrench	Torque
φ 63-200			5.0Nm
	SP050130	DT-TP20	

AFM45-XN09-W
45° Approach angle face milling cutter with wedge clamping

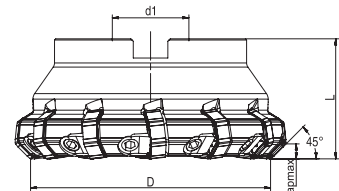

Product code	D	d1	L	l1	apmax	Internal coolant	Z	Inserts
AFM45-080-Z09-A27R-XN09-W	80	27	50	-	6.0		9	XN..U 0906
AFM45-100-Z12-A32R-XN09-W	100	32	50	-	6.0		12	
AFM45-125-Z16-A40R-XN09-W	125	40	63	-	6.0		16	
AFM45-125-Z16-A40L-XN09-W	125	40	63	-	6.0		16	
AFM45-160-Z20-A40R-XN09-W	160	40	63	-	6.0		20	
AFM45-160-Z20-A40L-XN09-W	160	40	63	-	6.0		20	
AFM45-200-Z26-A60R-XN09-W	200	60	63	-	6.0		26	
AFM45-200-Z26-A60L-XN09-W	200	60	63	-	6.0		26	

Dimension(mm)	Spare parts		
Cutter diameter	Screw	Wrench	Torque
φ 80-200			7.0Nm
	AWG-8H	AWS830F	

Note: With internal coolant
 Without internal coolant

Product code	Dimension(mm)		Grades						
	Insert corner radius mm	Wiper length mm	AP301U	AP351U	AC301P	AP401U	AC301K	AP351K	AW100K
XNGU 0906ANN-MM3	0.8	1.4	●	●	●		●		
XNGU 0906ANN-MM4	0.8	1.4	●	●	●		●		
XNMU 0906ANN-MR6	0.8	1.4	●				●	●	
XNMU 090612-MM4	1.2	-	●	●		●	●	●	
XNGX 0906ANN-W	1.0	7.5	●				●		

Marked : ● Stock available ○ Non-stocked standard

Materials				Cutting depth and feed									
ISO	Material classification	Tensile strength (N/mm ²)	Hardness (HB)	XN..0906..									
				ap	Geometry								
					MM3		MM4		MR6				
					fz								
(mm)													
min		max		min		max		min		max			
P	Unalloyed steel	<600	<180	0.20	6.00	0.15	0.35	0.18	0.38	0.18	0.40		
		<950	<280										
	Alloyed steel	700-950	200-280			0.12	0.32	0.15	0.35	0.15	0.38		
		950-1200	280-355										
	1200-1400	355-415											
M	Duplex stainless steel	778	230										
	Austenitic stainless steel	675	200			0.12	0.30	0.12	0.32	-	-		
	Precipitation-hardening stainless steel	1013	300										
K	Grey cast iron	700	220										
	Nodular cast iron	880	260			0.15	0.35	0.18	0.38	0.18	0.40		
	Malleable cast iron	800	250										
S	Fe-based alloy	943	280										
	Co-based alloy	1076	320										
	Ni-based alloy	1177	350	0.10	0.25	0.12	0.28	-	-				
	Ti-alloy	1262	370										
N	Aluminum	260	75										
	Aluminum alloy	447	130	-	-	-	-	-	-				
H	Hardened steel	-	50-60HRC										
	Chilled cast iron	-	55HRC	-	-	-	-	-	-				

*The recommended cutting conditions always refer to general conditions. These cutting conditions should be adjusted according to the practical machine rigidity, tools, workpiece clamping and coolants. $f_z = \frac{h_m}{\sqrt{\frac{a_e}{D_c}}}$, (calculate for $\frac{a_e}{D_c} < 30\%$)



Milling cutters

AFF40-LN12/LN15

Cast iron finishing milling cutter

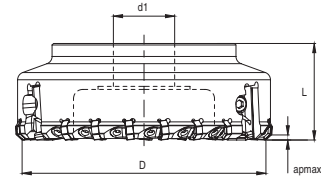

Product code	D	d1	L	apmax	Internal coolant	*Z	Cutting edge for finishing machining	Inserts
AFF40-080-Z08-A27R-LN12	80	27	50	0.5		8+2	2	ONHF 050408-MM3 LNHQ 120408FN-W
AFF40-100-Z10-A32R-LN12	100	32	50	0.5		10+2	2	
AFF40-125-Z15-A40R-LN15	125	40	63	0.5		15+3	3	ONHF 050408-MM3 LNHQ 150416FN-W
AFF40-160-Z18-A40R-LN15	160	40	63	0.5		18+3	3	
AFF40-200-Z24-A60R-LN15	200	60	63	0.5		24+3	3	
AFF40-250-Z30-A60R-LN15	250	60	63	0.5		30+3	3	

Dimension	Spare parts				
Cutter diameter	wedge type	wedge locking screw	wiper insert locking screw	wiper insert adjusting screw	wiper cartridge locking screw
φ 80-250					
	AWG-6H-13B	WD060200	SP040085H	AH050100F	SH060250

Dimension	Spare parts				
Cutter diameter	wedge screw wrench	wiper insert screw wrench	wiper insert adjusting screw wrench	wiper insert cartridge locking screw wrench	wiper cartridge
φ 80-250					
	LT-H3	DT-TP10	LT-H2.5	LT-H5	D80-100
					C-LN1235-2545
					D125-250
					C-LN1535-2545

Note: With internal coolant
 Without internal coolant



Product code	Dimension(mm)		Grades
	Insert corner radius mm	Wiper length mm	APT151H
ONHF 050408-MM3	0.8	-	●
LNHQ 120408FN-W	0.8	-	●
LNHQ 150416FN-W	1.6	-	●

Marked : ● Stock available ○ Non-stocked standard

Milling cutters

Materials				Cutting depth and feed				
ISO	Material classification	Tensile strength (N/mm ²)	Hardness (HB)	ONHF..05 + LNHQ..12				
				ap	Geometry		MM3 + W	
					fz			
				(mm)				min
	Grey cast iron	700	220	0.20	0.50	0.08	0.25	
	Nodular cast iron	880	260					
	Malleable cast iron	800	250					

*The recommended cutting conditions always refer to general conditions. These cutting conditions should be adjusted according to the practical machine rigidity, tools, workpiece clamping and coolants. $f_z = \frac{h_m}{\sqrt{\frac{a_e}{D_c}}}$, (calculate for $\frac{a_e}{D_c} < 30\%$)

ASM90-LN09-C
90° Shoulder milling cutter

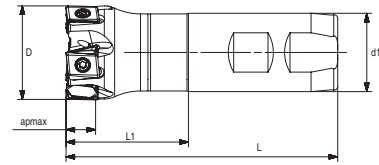
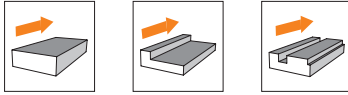

Product code	D	d1	L	l1	apmax	Internal coolant	Z	Inserts
ASM90-025-Z03-W25R-LN09-C	25	25	100	45	8		3	LNHU 0904
ASM90-025-Z04-W25R-LN09-C	25	25	100	45	8		4	
ASM90-032-Z04-W32R-LN09-C	32	32	110	50	8		4	
ASM90-032-Z05-W32R-LN09-C	32	32	110	50	8		5	
ASM90-040-Z04-W32R-LN09-C	40	32	110	25	8		4	
ASM90-040-Z06-W32R-LN09-C	40	32	110	25	8		6	

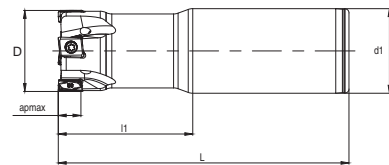

Product code	D	d1	L	l1	apmax	Internal coolant	Z	Inserts
ASM90-020-Z02-C20R-LN09-L110	20	20	110	31	8		2	LNHU 0904
ASM90-020-Z03-C20R-LN09-L110	20	20	110	31	8		3	
ASM90-025-Z03-C25R-LN09-L200-C	25	25	200	40	8		3	
ASM90-025-Z04-C25R-LN09-L200-C	25	25	200	40	8		4	
ASM90-032-Z04-C32R-LN09-L250-C	32	32	250	50	8		4	
ASM90-032-Z05-C32R-LN09-L250-C	32	32	250	50	8		5	

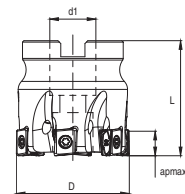

Product code	D	d1	L	ISO	apmax	Internal coolant	Z	Inserts
ASM90-040-Z04-A16R-LN09-C	40	16	40	A	8		4	LNHU 0904
ASM90-040-Z06-A16R-LN09-C	40	16	40	A	8		6	
ASM90-050-Z05-A22R-LN09-C	50	22	40	A	8		5	
ASM90-050-Z07-A22R-LN09-C	50	22	40	A	8		7	
ASM90-063-Z07-A22R-LN09-C	63	22	40	A	8		7	
ASM90-063-Z10-A22R-LN09-C	63	22	40	A	8		10	
ASM90-080-Z09-A27R-LN09-C	80	27	50	A	8		9	
ASM90-080-Z13-A27R-LN09-C	80	27	50	A	8		13	

Note: With internal coolant
 Without internal coolant

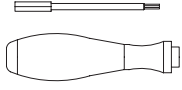

Dimension(mm)	Spare parts		
Cutter diameter	Screw	Wrench	Torque
φ 20-80			1.8Nm
	SP030083	DT-TP09	

Product code	Dimension(mm)		Grade						
	Insert corner radius mm	Wiper length mm	AP301U	AC301P	AP351U	AP403M	AC301K	AP351K	AW100K
LNHU 090404ER-FM2	0.4	1.85							●
LNHU 090404ER-MM3	0.4	1.85			●	●			
LNHU 090404ER-MR2	0.4	1.85	●		●	●	●	●	
LNHU 090408ER-MR2	0.8	1.3	●		●	●	●	●	
LNHU 090412ER-MR2	1.2	1.0	●			●	●		
LNHU 090416ER-MR2	1.6	0.65	●			●	●		
LNHU 090420ER-MR2	2.0	0.65	●			●	●		
LNHU 0904PDER-W	0.4	3.6	●				●		

Marked : ● Stock available ○ Non-stocked standard

Materials				Cutting depth and feed									
ISO	Material classification	Tensile strength (N/mm ²)	Hardness (HB)	LNHU 0904..									
				ap	Geometry								
					MR2		MM3		FM2				
					fz								
(mm)													
min		max		min		max		min		max			
P	Unalloyed steel	<600	<180	0.20	8.00	0.08	0.28	0.08	0.25	-	-		
		<950	<280										
	Alloyed steel	700-950	200-280			0.06	0.22	0.06	0.20	-	-		
		950-1200	280-355										
	1200-1400	355-415											
M	Duplex stainless steel	778	230										
	Austenitic stainless steel	675	200			0.06	0.22	0.06	0.20	-	-		
	Precipitation-hardening stainless steel	1013	300										
K	Grey cast iron	700	220					0.08	0.30	0.08	0.28	-	-
	Nodular cast iron	880	260										
	Malleable cast iron	800	250										
S	Fe-based alloy	943	280							0.08	0.15	-	-
	Co-based alloy	1076	320										
	Ni-based alloy	1177	350										
	Ti-alloy	1262	370										
N	Aluminum	260	75							0.06	0.25		
	Aluminum alloy	447	130										
H	Hardened steel	-	50-60HRC										
	Chilled cast iron	-	55HRC										

*The recommended cutting conditions always refer to general conditions. These cutting conditions should be adjusted according to the practical machine rigidity, tools, workpiece clamping and coolants. $f_z = \frac{h_m}{\sqrt{\frac{a_e}{D_c}}}$, (calculate for $\frac{a_e}{D_c} < 30\%$)



P248

Milling cutters

ASM90-LN13-C
90° Shoulder milling cutter

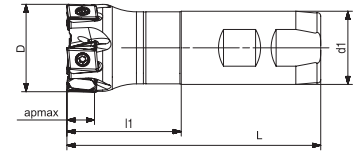
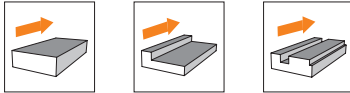

Product code	D	d1	L	l1	apmax	Internal coolant	Z	Inserts
ASM90-040-Z5-W32R-LN13-C	40	32	120	50	12		5	LNHU 1306

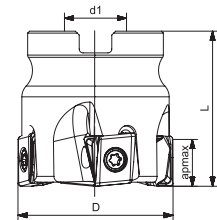

Product code	D	d1	L	l1	apmax	Internal coolant	Z	Inserts
ASM90-040-Z04-A16R-LN13-C	40	16	40	-	12.0		4	LNHU 1306
ASM90-040-Z05-A16R-LN13-C	40	16	40	-	12.0		5	
ASM90-050-Z05-A22R-LN13-C	50	22	40	-	12.0		5	
ASM90-050-Z06-A22R-LN13-C	50	22	40	-	12.0		6	
ASM90-063-Z04-A22R-LN13-C	63	22	40	-	12.0		4	
ASM90-063-Z06-A22R-LN13-C	63	22	40	-	12.0		6	
ASM90-063-Z08-A22R-LN13-C	63	22	40	-	12.0		8	
ASM90-080-Z05-A27R-LN13-C	80	27	50	-	12.0		5	
ASM90-080-Z07-A27R-LN13-C	80	27	50	-	12.0		7	
ASM90-080-Z10-A27R-LN13-C	80	27	50	-	12.0		10	
ASM90-100-Z07-A32R-LN13-C	100	32	50	-	12.0		7	
ASM90-100-Z09-A32R-LN13-C	100	32	50	-	12.0		9	
ASM90-100-Z13-A32R-LN13-C	100	32	50	-	12.0		13	
ASM90-125-Z09-A40R-LN13-C	125	40	63	-	12.0		9	
ASM90-125-Z11-A40R-LN13-C	125	40	63	-	12.0		11	
ASM90-125-Z16-A40R-LN13-C	125	40	63	-	12.0		16	
ASM90-160-Z09-A40R-LN13	160	40	63	-	12.0		9	
ASM90-160-Z13-A40R-LN13	160	40	63	-	12.0		13	

Dimension(mm)	Spare parts		
Cutter diameter	Screw	Wrench	Torque
φ 40-160			3.5Nm
	SP040115	DT-TP15	

Note: With internal coolant
 Without internal coolant



Product code	Dimension(mm)		Grade						
	Insert corner radius mm	Wiper length mm	AP301U	AC301P	AP351U	AP401U	AC301K	AP351K	AW100K
LNHU 130608ER-FM2	0.8	2.7							●
LNHU 130608ER-MM3	0.8	2.7				●			
LNHU 130608ER-MR2	0.8	2.7	●	●	●	●	●	●	
LNHU 130612ER-MR2	1.2	2.3			●	●	●		
LNHU 130616ER-MR2	1.6	1.9			●	●	●		
LNHU 130620ER-MR2	2.0	1.5			●	●			
LNHU 130624ER-MR2	2.4	1.0			●	●			
LNHU 130631ER-MR2	3.1	0.4			●	●	●		
LNHU 1306PDER-W	0.8	5.6	●				●		

Marked : ● Stock available ○ Non-stocked standard

Materials				Cutting depth and feed							
ISO	Material classification	Tensile strength (N/mm ²)	Hardness (HB)	LNHU..1306..							
				ap	Geometry						
					MM3		MR2				
					fz						
(mm)											
min	max	min	max	min	max						
P	Unalloyed steel	<600	<180	0.20	12.00	0.10	0.30	0.12	0.35		
		<950	<280								
	Alloyed steel	700-950	200-280			0.08	0.25	0.10	0.30		
		950-1200	280-355								
	1200-1400	355-415									
M	Duplex stainless steel	778	230								
	Austenitic stainless steel	675	200			0.06	0.20	0.08	0.25		
	Precipitation-hardening stainless steel	1013	300								
K	Grey cast iron	700	220								
	Nodular cast iron	880	260								
	Malleable cast iron	800	250								
S	Fe-based alloy	943	280								
	Co-based alloy	1076	320								
	Ni-based alloy	1177	350	0.06	0.18	0.08	0.22				
	Ti-alloy	1262	370								
N	Aluminum	260	75								
	Aluminum alloy	447	130								
H	Hardened steel	-	50-60HRC								
	Chilled cast iron	-	55HRC					0.08	0.20		

*The recommended cutting conditions always refer to general conditions. These cutting conditions should be adjusted according to the practical machine rigidity, tools, workpiece clamping and coolants. $f_z = \frac{h_m}{\sqrt{\frac{a_e}{D_c}}}$, (calculate for $\frac{a_e}{D_c} < 30\%$)



Milling cutters

ASM90-LN16-C
90° Shoulder milling cutter

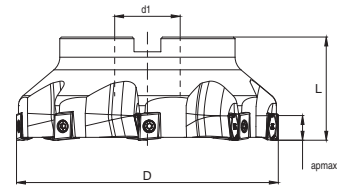
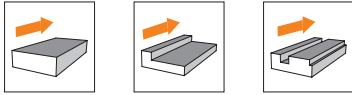

Product code	D	d1	L	ISO	apmax	Internal coolant	Z	Inserts
ASM90-063-Z04-A22R-LN16-C	63	22	40	A	15		4	LNHU 1607
ASM90-080-Z05-A27R-LN16-C	80	27	50	A	15		5	
ASM90-125-Z07-A40R-LN16-C	125	40	63	A	15		7	
ASM90-160-Z08-A40R-LN16	160	40	63	A	15		8	

Dimension(mm)	Spare parts		
Cutter diameter	Screw	Wrench	Torque
φ 63-160			5Nm
	SP05013063	DT-TP20	

Note: With internal coolant
 Without internal coolant



ASM90-WN08-C
90° Shoulder milling cutter

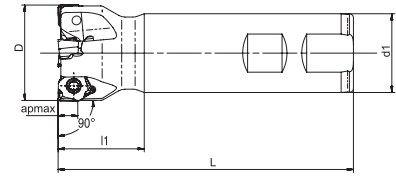
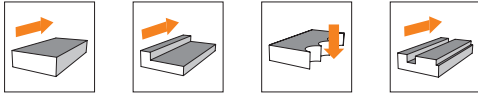

Product code	D	d1	L	l1	apmax	Internal coolant	Z	Inserts
ASM90-040-Z03-W32R-WN08-C	40	32	120	35	7.0		3	WN.U 0806
ASM90-040-Z04-W32R-WN08-C	40	32	120	35	7.0		4	

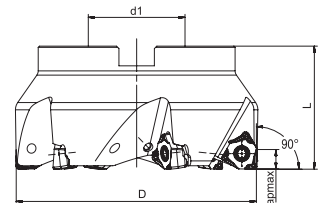

Product code	D	d1	L	l1	apmax	Internal coolant	Z	Inserts
ASM90-050-Z04-A22R-WN08-C	50	22	40	-	7		4	WN.U 0806
ASM90-050-Z05-A22R-WN08-C	50	22	40	-	7		5	
ASM90-063-Z04-A22R-WN08-C	63	22	40	-	7		4	
ASM90-063-Z06-A22R-WN08-C	63	22	40	-	7		6	
ASM90-063-Z07-A22R-WN08-C	63	22	40	-	7		7	
ASM90-080-Z05-A27R-WN08-C	80	27	50	-	7		5	
ASM90-080-Z07-A27R-WN08-C	80	27	50	-	7		7	
ASM90-080-Z09-A27R-WN08-C	80	27	50	-	7		9	
ASM90-100-Z06-A32R-WN08-C	100	32	50	-	7		6	
ASM90-100-Z08-A32R-WN08-C	100	32	50	-	7		8	
ASM90-100-Z11-A32R-WN08-C	100	32	50	-	7		11	
ASM90-125-Z07-A40R-WN08-C	125	40	63	-	7		7	
ASM90-125-Z11-A40R-WN08-C	125	40	63	-	7		11	
ASM90-125-Z13-A40R-WN08-C	125	40	63	-	7		13	
ASM90-160-Z08-A40R-WN08	160	40	63	-	7		8	
ASM90-160-Z12-A40R-WN08	160	40	63	-	7		12	

Dimension(mm)	Spare parts		
Cutter diameter	Screw	Wrench	Torque
φ 40-160			3.5Nm
	ST040085H	DT-TP10	

Note: With internal coolant
 Without internal coolant



Product code	Dimension(mm)		Grade						
	Insert corner radius mm	Wiper length mm	AP301U	AC301P	AP351U	AP401U	AC301K	AP351K	AW100K
WNHU 080608R-FM2	0.8	2.0							●
WNGU 080604R-MM3	0.4	2.2			●	●			
WNGU 080608R-MM3	0.8	2.0	●		●	●			
WNGU 080604R-MM4	0.4	2.2	●		●	●		●	
WNGU 080608R-MM4	0.8	2.0	●	●	●	●	●	●	
WNGU 080612R-MM4	1.2	1.6	●		●	●			
WNGU 080616R-MM4	1.6	1.2	●		●	●			
WNGU 080608R-MR2	0.8	2.0	●					●	
WNGU 080612R-MR2	1.2	1.6	●					●	
WNGU 080616R-MR2	1.6	1.2	●					●	
WNHX 0806ZZR-W	1.0	4.8	●				●		

Marked : ● Stock available ○ Non-stocked standard

Milling cutters

Materials				Cutting depth and feed													
ISO	Material classification	Tensile strength (N/mm ²)	Hardness (HB)	WNGU..0806..													
				ap	Geometry				fz								
					FM2	MM3	MM4	MR2									
					(mm)												
min	max	min	max	min	max	min	max	min	max								
P	Unalloyed steel	<600	<180	0.20	7.00			0.12	0.25	0.12	0.28	0.12	0.30				
		<950	<280														
	Alloyed steel	700-950	200-280					0.10	0.20	0.10	0.25	0.10	0.28				
		950-1200	280-355														
	1200-1400	355-415															
M	Duplex stainless steel	778	230														
	Austenitic stainless steel	675	200									0.08	0.18	0.08	0.18	-	-
	Precipitation-hardening stainless steel	1013	300														
K	Grey cast iron	700	220														
	Nodular cast iron	880	260									0.12	0.20	0.10	0.28	0.15	0.30
	Malleable cast iron	800	250														
S	Fe-based alloy	943	280														
	Co-based alloy	1076	320														
	Ni-based alloy	1177	350					0.12	0.13	0.10	0.15	-	-				
	Ti-alloy	1262	370														
N	Aluminum	260	75			0.10	0.24	-	-	-	-	-	-				
	Aluminum alloy	447	130														
H	Hardened steel	-	50-60HRC														
	Chilled cast iron	-	55HRC														

*The recommended cutting conditions always refer to general conditions. These cutting conditions should be adjusted according to the practical machine rigidity, tools, workpiece clamping and coolants. $f_z = \frac{h_m}{\sqrt{\frac{a_e}{D_c}}}$, (calculate for $\frac{a_e}{D_c} < 30\%$)



ASM90-AP10-C
90° Shoulder milling cutter

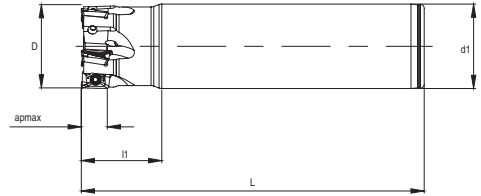
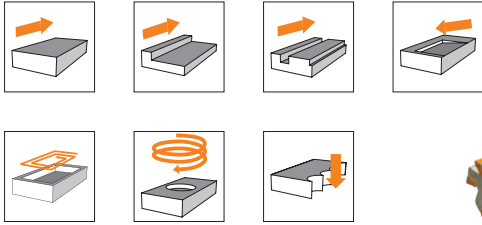

Product code	D	d1	L	l1	apmax	Internal coolant	Z	Inserts
ASM90-016-Z02-C16R-AP10-L90-C	16	16	90	26	8		2	APKT 1003
ASM90-020-Z03-C20R-AP10-L110-C	20	20	110	28	8		3	
ASM90-025-Z04-C25R-AP10-L120-C	25	25	120	30	8		4	
ASM90-032-Z05-C32R-AP10-L130-C	32	32	130	26	8		5	

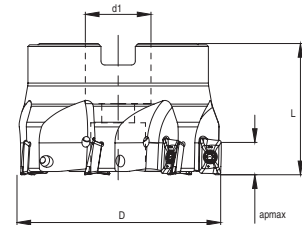

Product code	D	d1	L	l1	apmax	Internal coolant	Z	Inserts
ASM90-063-Z07-A22R-AP10-C	63	22	40	A	8		7	APKT 1003

Dimension(mm)	Spare parts		
	Screw	Wrench	Torque
φ 16-63			1.0Nm
	SP02506450H	DT-TP08	

Note: With internal coolant
 Without internal coolant



Product code	Dimension(mm)		Grade						
	Insert corner radius mm	Wiper length mm	AP301U	AC301P	AP351U	AP401U	AC301K	AP351K	AP403S
APKT 1003PDER-IT	0.8	1.09			●	●			●

Marked : ● Stock available ○ Non-stocked standard

Materials				Cutting depth and feed			
ISO	Material classification	Tensile strength (N/mm ²)	Hardness (HB)	APKT..1003..			
				ap	Geometry		
					IT		
					fz		
(mm)				min	max	min	max
P	Unalloyed steel	<600	<180				
		<950	<280				
	Alloyed steel	700-950	200-280				
		950-1200	280-355				
1200-1400		355-415					
M	Duplex stainless steel	778	230	0.05	0.15		
	Austenitic stainless steel	675	200				
	Precipitation-hardening stainless steel	1013	300				
K	Grey cast iron	700	220	-	-		
	Nodular cast iron	880	260				
	Malleable cast iron	800	250				
S	Fe-based alloy	943	280	0.05	0.15		
	Co-based alloy	1076	320				
	Ni-based alloy	1177	350				
	Ti-alloy	1262	370				
N	Aluminum	260	75	0.05	0.25		
	Aluminum alloy	447	130				
H	Hardened steel	-	50-60HRC	-	-		
	Chilled cast iron	-	55HRC				

*The recommended cutting conditions always refer to general conditions. These cutting conditions should be adjusted according to the practical machine rigidity, tools, workpiece clamping and coolants. $f_z = \frac{h_m}{\sqrt{\frac{a_e}{D_c}}}$, (calculate for $\frac{a_e}{D_c} < 30\%$)



Milling cutters

ASM90-AP17-C
90° Shoulder milling cutter

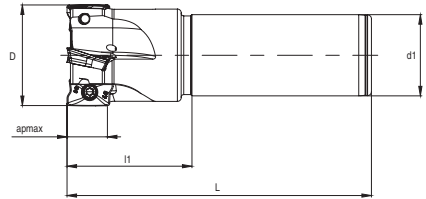
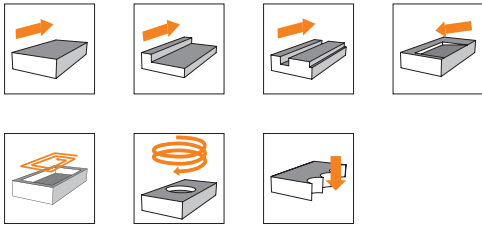

Product code	D	d1	L	l1	apmax	Internal coolant	Z	Inserts
ASM90-025-Z02-C25R-AP17-L100-C	25	25	100	39	16		2	APKT 1705
ASM90-032-Z03-C32R-AP17-L110-C	32	32	110	40	16		3	
ASM90-040-Z04-C32R-AP17-L120-C	40	32	120	45	16		4	

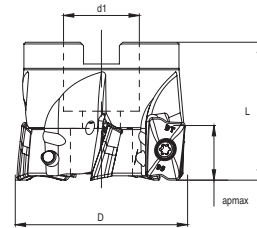
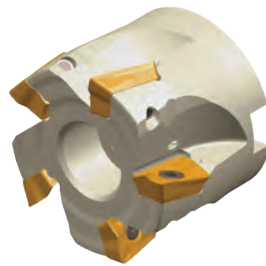

Product code	D	d1	L	l1	apmax	Internal coolant	Z	Inserts
ASM90-050-Z05-A22R-AP17-C	50	22	40	-	16		5	APKT 1705
ASM90-063-Z06-A22R-AP17-C	63	22	40	-	16		6	

Dimension(mm)	Spare parts		
Cutter diameter	Screw	Wrench	Torque
\varnothing 25 \varnothing 32-63	 SP040084 SP040093	 DT-TP15	4.0Nm

Note: With internal coolant
 Without internal coolant



APE90-LN09
90° Procupine milling cutter

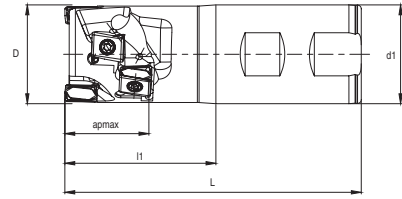
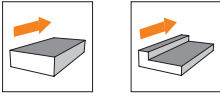

Product code	D	d1	L	L1	d2	d3	d4	apmax	Internal coolant	clamping screw	Z	row	Insert number	Inserts
APE90-025-Z02-W25R-LN09-L32-F-C	25	25	100	43	-	-	-	32		-	2	4	8	LNHU 0904
APE90-032-Z02-W32R-LN09-L32-F-C	32	32	105	44	-	-	-	32		-	2	4	8	
APE90-032-Z02-W32R-LN09-L40-F-C	32	32	110	50	-	-	-	40		-	2	5	10	
APE90-040-Z03-W40R-LN09-L40-F-C	40	40	125	55	-	-	-	40		-	3	5	15	
APE90-040-Z03-W40R-LN09-L48-F-C	40	40	130	59	-	-	-	48		-	3	6	18	

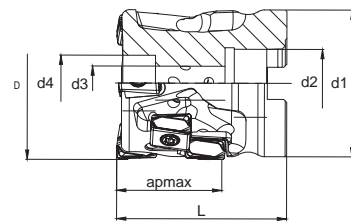

Product code	D	d1	L	L1	d2	d3	d4	apmax	Internal coolant	clamping screw	Z	row	Insert number	Inserts
APE90-040-Z03-A16R-LN09-L32-F-C	40	38	55	-	16	9	15	32		SH080400	3	4	12	LNHU 0904
APE90-040-Z03-A16R-LN09-L40-F-C	40	38	65	-	16	9	15	40		SH080500	3	5	15	
APE90-050-Z04-A22R-LN09-L48-F-C	50	47.5	75	-	22	11	18	48		SH100550	4	6	24	

clamping screw	Designation	screw type	clamping torque
	SH080400	M8*40	41Nm
	SH080500	M8*50	41Nm
	SH100550	M10*55	81Nm

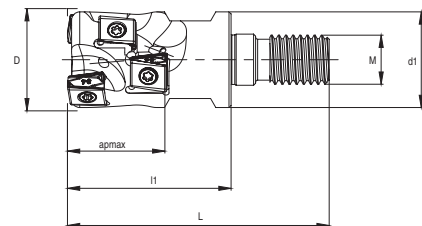

Product code	D	d1	L	L1	d2	d3	d4	apmax	Internal coolant	clamping screw	Z	row	Insert number	Inserts
APE90-025-Z02-M12R-LN09-L24-F-C	25	23.4	64	40	12	-	-	24		-	2	3	6	LNHU 0904
APE90-032-Z02-M16R-LN09-L24-F-C	32	30	67	40	16	-	-	24		-	2	3	6	
APE90-032-Z02-M16R-LN09-L32-F-C	32	30	77	50	16	-	-	32		-	2	4	8	

Dimension(mm)	Spare parts			
Cutter diameter	Screw	Wrench	wrench	Torque
φ 25-50				1.8Nm
	SP030083	DT-TP09	AFW-15/24	



Note: With internal coolant
 Without internal coolant

Product code	Dimension(mm)		Grade						
	Insert corner radius mm	Wiper length mm	AP301U	AC301P	AP351U	AP403M	AC301K	AP351K	AW100K
LNHU 090404ER-FM2	0.4	1.85							●
LNHU 090404ER-MM3	0.4	1.85			●	●			
LNHU 090404ER-MR2	0.4	1.85	●		●	●	●	●	
LNHU 090408ER-MR2	0.8	1.3	●		●	●	●	●	
LNHU 090412ER-MR2	1.2	1.0	●			●	●		
LNHU 090416ER-MR2	1.6	0.65	●			●	●		
LNHU 090420ER-MR2	2.0	0.65	●			●	●		
LNHU 0904PDER-W	0.4	3.6	●				●		

Marked : ● Stock available ○ Non-stocked standard

Milling cutters

Materials				Cutting depth and feed									
ISO	Material classification	Tensile strength (N/mm ²)	Hardness (HB)	LNHU..0904..									
				ap	Geometry								
					MM3		MR2		FM2				
					fz								
(mm)													
min		max		min		max		min		max			
P	Unalloyed steel	<600	<180	0.20	48.00	0.06	0.22	0.08	0.25	-	-		
		<950	<280										
	Alloyed steel	700-950	200-280			0.05	0.18	0.06	0.20	-	-		
		950-1200	280-355										
	1200-1400	355-415											
M	Duplex stainless steel	778	230					0.05	0.18	0.06	0.18	-	-
	Austenitic stainless steel	675	200										
	Precipitation-hardening stainless steel	1013	300										
K	Grey cast iron	700	220					0.05	0.22	0.08	0.25	-	-
	Nodular cast iron	880	260										
	Malleable cast iron	800	250										
S	Fe-based alloy	943	280			0.05	0.15	-	-	-	-		
	Co-based alloy	1076	320										
	Ni-based alloy	1177	350										
	Ti-alloy	1262	370										
N	Aluminum	260	75			-	-	-	-	0.06	0.25		
	Aluminum alloy	447	130										
H	Hardened steel	-	50-60HRC			-	-	0.05	0.12	-	-		
	Chilled cast iron	-	55HRC										

*The recommended cutting conditions always refer to general conditions. These cutting conditions should be adjusted according to the practical machine rigidity, tools, workpiece clamping and coolants. $f_z = \frac{h_m}{\sqrt{\frac{a_e}{D_c}}}$, (calculate for $\frac{a_e}{D_c} < 30\%$)



APE90-LN13
90° Porcupine milling cutter

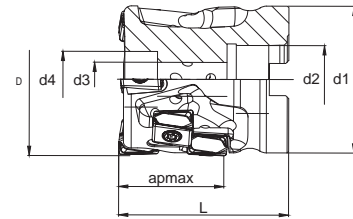
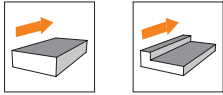

Product code	D	d1	L	L1	d2	d3	d4	apmax	Internal coolant	Z	Row	Insert number	Inserts
APE90-040-Z02-A16R-LN13-L34-F-C	40	39	55	-	16	9	15	34		2	3	6	LNHU 1306
APE90-040-Z02-A16R-LN13-L45-F-C	40	39	65	-	16	9	15	45		2	4	8	
APE90-050-Z03-A22R-LN13-L34-F-C	50	47.5	55	-	22	11	18	34		3	3	9	
APE90-050-Z03-A22R-LN13-L45-F-C	50	47.5	65	-	22	11	18	45		3	4	12	
APE90-063-Z04-A27R-LN13-L56-F-C	63	59.5	80	-	27	14	20	56		4	5	20	
APE90-063-Z04-A27R-LN13-L45-F-C	63	59.5	70	-	27	14	20	45		4	4	16	
APE90-080-Z05-A32R-LN13-L56-F-C	80	75.6	85	-	32	18	26	56		5	5	25	

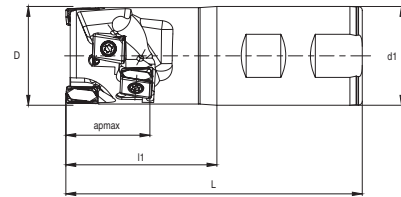

Product code	D	d1	L	L1	d2	d3	d4	apmax	Internal coolant	Z	Row	Insert number	Inserts
APE90-040-Z02-W40R-LN13-L34-F-C	40	40	120	54	-	-	-	34		2	3	6	LNHU 1306
APE90-040-Z02-W40R-LN13-L45-F-C	40	40	135	64	-	-	-	45		2	4	8	

Dimension(mm)	Spare parts		
Cutter diameter	Screw	Wrench	Torque
φ 40-80			3.5Nm
	SP040115	DT-TP15	

Note: With internal coolant
 Without internal coolant



Product code	Dimension(mm)		Grade						
	Insert corner radius mm	Wiper length mm	AP301U	AC301P	AP351U	AP401U	AC301K	AP351K	AW100K
LNHU 130608ER-FM2	0.8	2.7							●
LNHU 130608ER-MM3	0.8	2.7				●			
LNHU 130608ER-MR2	0.8	2.7	●	●	●	●	●	●	
LNHU 130612ER-MR2	1.2	2.3			●	●	●		
LNHU 130616ER-MR2	1.6	1.9			●	●	●		
LNHU 130620ER-MR2	2.0	1.5			●	●			
LNHU 130624ER-MR2	2.4	1.0			●	●			
LNHU 130631ER-MR2	3.1	0.4			●	●	●		
LNHU 1306PDER-W	0.8	5.6	●				●		

Marked : ● Stock available ○ Non-stocked standard

Milling cutters

Materials				Cutting depth and feed								
ISO	Material classification	Tensile strength (N/mm ²)	Hardness (HB)	LNHU..1306..								
				ap	Geometry							
					MM3		MR2		FM2			
					fz							
(mm)												
min		max		min		max		min		max		
P	Unalloyed steel	<600	<180	0.20	56	0.10	0.28	0.10	0.30	-	-	
		<950	<280									
	Alloyed steel	700-950	200-280			0.08	0.25	0.08	0.28	-	-	
		950-1200	280-355									
M	Duplex stainless steel	778	230									
	Austenitic stainless steel	675	200			0.08	0.22	0.08	0.25	-	-	
	Precipitation-hardening stainless steel	1013	300									
K	Grey cast iron	700	220									
	Nodular cast iron	880	260			-	-	0.10	0.32	-	-	
	Malleable cast iron	800	250									
S	Fe-based alloy	943	280									
	Co-based alloy	1076	320									
	Ni-based alloy	1177	350	0.08	0.2	-	-	-	-			
	Ti-alloy	1262	370									
N	Aluminum	260	75									
	Aluminum alloy	447	130	-	-	-	-	0.08	0.30			
H	Hardened steel	-	50-60HRC									
	Chilled cast iron	-	55HRC	-	-	0.06	0.15	-	-			

*The recommended cutting conditions always refer to general conditions. These cutting conditions should be adjusted according to the practical machine rigidity, tools, workpiece clamping and coolants. $f_z = \frac{h_m}{\sqrt{\frac{a_e}{D_c}}}$, (calculate for $\frac{a_e}{D_c} < 30\%$)



APM00-RP
Ballnose milling cutter

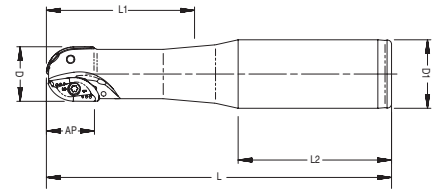

Product code	D	d1	L	l1	l2	apmax	M	Internal coolant	Z	Inserts
APM00-016-Z02-C20R-RP080-L120-C	16	20	120	50	70	14	-		2	RPM 080ER-MM4
APM00-020-Z02-C25R-RP100-L126-C	20	25	126	62	64	18	-		2	RPM 100ER-MM4
APM00-020-Z02-C25R-RP100-L176-C	20	25	176	70	106	18	-		2	

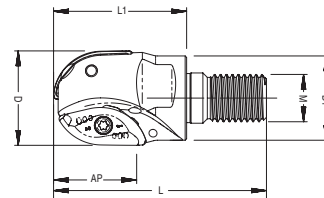

Product code	D	d1	L	l1	l2	apmax	M	Internal coolant	Z	Inserts
APM00-016-Z02-M10R-RP080-C	16	18	49	28	-	14	M10		2	RPM 080ER-MM4
APM00-020-Z02-M10R-RP100-C	20	18	51	30	-	18	M10		2	RPM 100ER-MM4

Dimension(mm)	Spare parts			
	Screw	Wrench	wrench	Torque
				1.8Nm
φ 16	SP02506450H	DT-TP08	AFW-15	
φ 20	SP030072H	DT-TP09	AFW-15	

Note: With internal coolant
 Without internal coolant



Product code	Dimension(mm)		Grade						
	Insert corner radius mm	Wiper length mm	AP301U	AC301P	AP351U	AP401U	AP351M	AP351K	AP403S
RPM 080ER-MM4	8	-				●	●		●
RPM 100ER-MM4	10	-				●	●		●

Marked : ● Stock available ○ Non-stocked standard

Materials				Cutting depth and feed					
ISO	Material classification	Tensile strength (N/mm ²)	Hardness (HB)	RPM....					
				ap		Geometry			
						MM4			
				(mm)		fz			
						min	max	min	max
P	Unalloyed steel	<600	<180	0.20	15.00	0.10	0.20		
		<950	<280						
	Alloyed steel	700-950	200-280					0.10	0.18
		950-1200	280-355						
M	Duplex stainless steel	778	230			0.10	0.18		
	Austenitic stainless steel	675	200						
	Precipitation-hardening stainless steel	1013	300						
K	Grey cast iron	700	220			-	-		
	Nodular cast iron	880	260						
	Malleable cast iron	800	250						
S	Fe-based alloy	943	280	0.06	0.12				
	Co-based alloy	1076	320						
	Ni-based alloy	1177	350						
	Ti-alloy	1262	370						
N	Aluminum	260	75	-	-				
	Aluminum alloy	447	130						
H	Hardened steel	-	50-60HRC	-	-				
	Chilled cast iron	-	55HRC						

*The recommended cutting conditions always refer to general conditions. These cutting conditions should be adjusted according to the practical machine rigidity, tools, workpiece clamping and coolants. $f_z = \frac{h_m}{\sqrt{\frac{a_e}{D_c}}}$, (calculate for $\frac{a_e}{D_c} < 30\%$)



P248

Milling cutters

APM00-RO08
Profile milling cutter

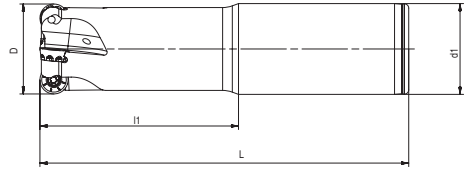

Product code	D	d1	L	l1	apmax	Internal coolant	Z	Inserts
APM00-016-Z02-W16R-RO08-L100	16	16	100	76	4		2	RO 0803
APM00-025-Z04-C25R-RO08-L116-C	25	25	116	60	4		4	

Dimension(mm)	Spare parts		
Cutter diameter	Screw	Wrench	Torque
φ 16-25			2.0Nm
	SP030062	DT-TP09	

Note: With internal coolant
 Without internal coolant



Product code	Dimension(mm)		Grade						
	IC	S	AP301U	AC301P	AP351U	AP401U	AP403M	AP351K	AP403S
ROHT 0803M0E-MM3	8	3.18					●		●

Marked : ● Stock available ○ Non-stocked standard

Milling cutters

Materials				Cutting depth and feed											
ISO	Material classification	Tensile strength (N/mm ²)	Hardness (HB)	ROHT..0803..											
				ap	Geometry										
					MM3										
					fz										
					0.1 < ap ≤ 1		0.1 < ap ≤ 4								
(mm)						min	max	min	max						
P	Unalloyed steel	<600	<180	0.20	4.00	0.15	0.50	0.08	0.30						
		<950	<280												
	Alloyed steel	700-950	200-280							0.12	0.45	0.06	0.28		
		950-1200	280-355												
M	Duplex stainless steel	778	230			0.10	0.40	0.06	0.25						
	Austenitic stainless steel	675	200												
	Precipitation-hardening stainless steel	1013	300												
K	Grey cast iron	700	220							-	-	-	-		
	Nodular cast iron	880	260												
	Malleable cast iron	800	250												
S	Fe-based alloy	943	280	0.10	0.35									0.06	0.25
	Co-based alloy	1076	320												
	Ni-based alloy	1177	350												
	Ti-alloy	1262	370												
N	Aluminum	260	75	-	-	-	-								
	Aluminum alloy	447	130												
H	Hardened steel	-	50-60HRC					-	-					-	-
	Chilled cast iron	-	55HRC												

*The recommended cutting conditions always refer to general conditions. These cutting conditions should be adjusted according to the practical machine rigidity, tools, workpiece clamping and coolants. $f_z = \frac{h_m}{\sqrt{\frac{a_e}{D_c}}}$, (calculate for $\frac{a_e}{D_c} < 30\%$)



APM00-RO10
Profile milling cutter

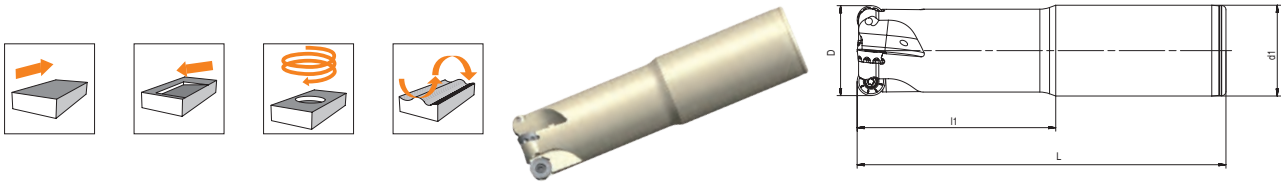

Product code	D	d1	L	l1	apmax	Internal coolant	Z	Inserts
APM00-025-Z03-C25R-RO10-L225-C	25	25	225	60	5		3	RO 10T3
APM00-032-Z04-C32R-RO10-L130-C	32	32	130	70	5		4	

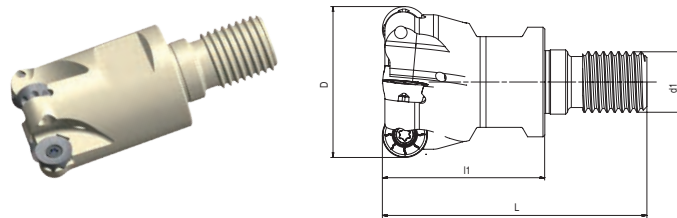

Product code	D	d1	L	l1	apmax	Internal coolant	Z	Inserts
APM00-025-Z03-M12R-RO10-C	25	M12	59	35	5		3	RO 10T3
APM00-032-Z04-M16R-RO10-C	32	M16	70	43	5		4	

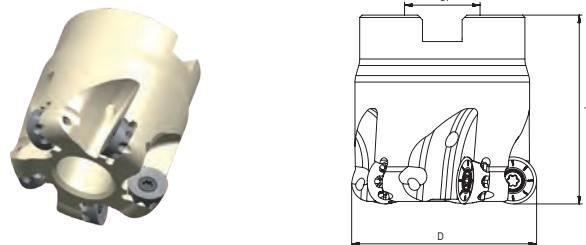

Product code	D	d1	L	l1	apmax	Internal coolant	Z	Inserts
APM00-040-Z05-A16R-RO10-C	40	16	40	-	5		5	RO 10T3
APM00-050-Z06-A22R-RO10-C	50	22	40	-	5		6	

Dimension(mm)	Spare parts		
Cutter diameter	Screw	Wrench	Torque
φ 25-50			2.0Nm
	SP030072H	DT-TP09	

Note: With internal coolant
 Without internal coolant



Product code	Dimension(mm)		Grade						
	IC	S	AP301U	AC301P	AP351U	AP401U	AP403M	AP351K	AP403S
ROHT 10T3M8E-MM3	10	3.97					●		●
ROMT 10T3M4E-MR6	10	3.97					●		●

Marked : ● Stock available ○ Non-stocked standard

Milling cutters

Materials				Cutting depth and feed										
ISO	Material classification	Tensile strength (N/mm ²)	Hardness (HB)	RO..10T3..										
				ap	Geometry									
					MM3				MR6					
					fz									
					0.1 < ap ≤ 1.2		1.2 < ap ≤ 5		0.1 < ap ≤ 1.2		1.2 < ap ≤ 5			
(mm)														
min		max		min		max		min		max				
P	Unalloyed steel	<600	<180	0.20	5.00	0.15	0.55	0.10	0.30	0.15	0.60	0.10	0.32	
		<950	<280											
	Alloyed steel	700-950	200-280			0.12	0.50	0.08	0.28	0.12	0.55	0.08	0.30	
		950-1200	280-355											
	1200-1400	355-415												
M	Duplex stainless steel	778	230											
	Austenitic stainless steel	675	200			0.10	0.45	0.08	0.25	0.10	0.50	0.08	0.28	
	Precipitation-hardening stainless steel	1013	300											
K	Grey cast iron	700	220					-	-	-	-	-	-	-
	Nodular cast iron	880	260											
	Malleable cast iron	800	250											
S	Fe-based alloy	943	280											
	Co-based alloy	1076	320	0.10	0.40	0.08	0.25	-	-	-	-			
	Ni-based alloy	1177	350											
	Ti-alloy	1262	370											
N	Aluminum	260	75			-	-	-	-	-	-			
	Aluminum alloy	447	130											
H	Hardened steel	-	50-60HRC			-	-	-	-	-	-			
	Chilled cast iron	-	55HRC											

*The recommended cutting conditions always refer to general conditions. These cutting conditions should be adjusted according to the practical machine rigidity, tools, workpiece clamping and coolants. $f_z = \frac{h_m}{\sqrt{\frac{a_e}{D_c}}}$, (calculate for $\frac{a_e}{D_c} < 30\%$)



APM00-RO12
Profile milling cutter



Product code	D	d1	L	l1	apmax	Internal coolant	Z	Inserts
APM00-032-Z03-C32R-RO12-L120-C	32	32	120	40	6		3	RO 1204

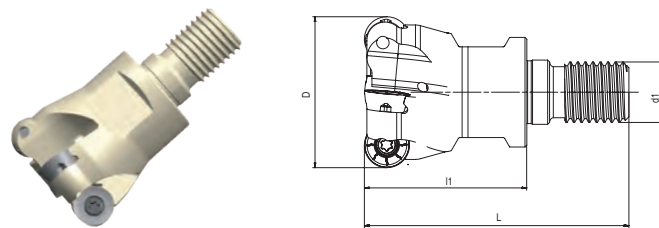

Product code	D	d1	L	l1	apmax	Internal coolant	Z	Inserts
APM00-040-Z04-M16R-RO12-C	40	M16	70	43	6		4	RO 1204

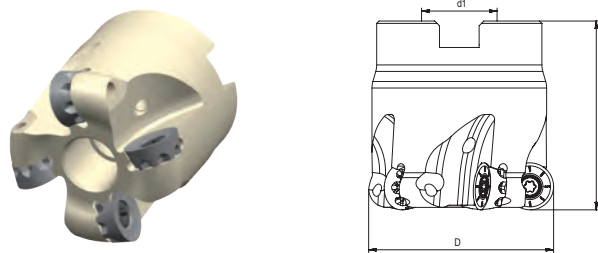

Product code	D	d1	L	l1	apmax	Internal coolant	Z	Inserts
APM00-040-Z04-A16R-RO12-C	40	16	40	-	6		4	RO 1204
APM00-050-Z05-A22R-RO12-C	50	22	40	-	6		5	
APM00-063-Z06-A22R-RO12-C	63	22	40	-	6		6	
APM00-080-Z07-A27R-RO12-C	80	27	50	-	6		7	

Dimension(mm)	Spare parts		
	Screw	Wrench	Torque
φ 32-80			4.0Nm
	SP040085H	DT-TP10	

Note: With internal coolant
 Without internal coolant



Product code	Dimension(mm)		Grade						
	IC	S	AP301U	AC301P	AP351U	AP401U	AP403M	AP351K	AP403S
ROHT 1204M4E-MM3	12	4.76					●		●
ROHT 1204M6E-MM3	12	4.76					●		●
ROMT 1204M6E-MR6	12	4.76					●		●

Marked : ● Stock available ○ Non-stocked standard

Milling cutters

Materials				Cutting depth and feed											
ISO	Material classification	Tensile strength (N/mm ²)	Hardness (HB)	RO..1204..											
				ap	Geometry										
					MM3				MR6						
					fz										
					0.1 < ap ≤ 1.5		1.5 < ap ≤ 6		0.1 < ap ≤ 1.5		1.5 < ap ≤ 6				
(mm)															
min		max		min		max		min		max					
P	Unalloyed steel	<600	<180	0.20	6.00	0.18	0.60	0.12	0.32	0.18	0.65	0.12	0.35		
		<950	<280												
	Alloyed steel	700-950	200-280			0.15	0.55	0.10	0.30	0.15	0.60	0.10	0.32		
		950-1200	280-355												
		1200-1400	355-415												
M	Duplex stainless steel	778	230					0.12	0.50	0.10	0.28	0.12	0.55	0.10	0.30
	Austenitic stainless steel	675	200												
	Precipitation-hardening stainless steel	1013	300												
K	Grey cast iron	700	220					-	-	-	-	-	-	-	-
	Nodular cast iron	880	260												
	Malleable cast iron	800	250												
S	Fe-based alloy	943	280												
	Co-based alloy	1076	320			0.12	0.45	0.10	0.28	-	-	-	-		
	Ni-based alloy	1177	350												
	Ti-alloy	1262	370												
N	Aluminum	260	75			-	-	-	-	-	-	-	-		
	Aluminum alloy	447	130												
H	Hardened steel	-	50-60HRC			-	-	-	-	-	-	-	-		
	Chilled cast iron	-	55HRC												

*The recommended cutting conditions always refer to general conditions. These cutting conditions should be adjusted according to the practical machine rigidity, tools, workpiece clamping and coolants. $f_z = \frac{h_m}{\sqrt{\frac{a_e}{D_c}}}$, (calculate for $\frac{a_e}{D_c} < 30\%$)



APM00-RO16
Profile milling cutter

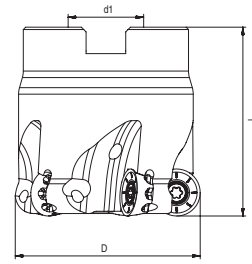
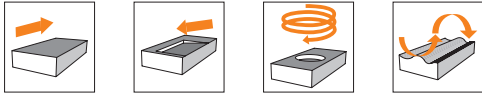

Product code	D	d1	L	l1	apmax	Internal coolant	Z	Inserts
APM00-063-Z05-A22R-RO16-C	63	22	40	-	8		5	RO 1605
APM00-080-Z06-A27R-RO16-C	80	27	50	-	8		6	
APM00-100-Z07-A32R-RO16-C	100	32	50	-	8		7	

Dimension(mm)	Spare parts		
	Screw	Wrench	Torque
φ 63-100			5.0Nm
	SP050120	DT-TP20	

Note: With internal coolant
 Without internal coolant



Product code	Dimension(mm)		Grade						
	IC	S	AP301U	AC301P	AP351U	AP401U	AP403M	AP351K	AP403S
ROHT 1605M8E-MM3	16	5.56					●		●
ROMT 1605M6E-MR6	16	5.56					●		●

Marked : ● Stock available ○ Non-stocked standard

Milling cutters

Materials				Cutting depth and feed										
ISO	Material classification	Tensile strength (N/mm ²)	Hardness (HB)	RO..1605..										
				ap	Geometry									
					MM3				MR6					
					fz									
				0.1 < ap ≤ 1.5		1.5 < ap ≤ 8		0.1 < ap ≤ 1.5		1.5 < ap ≤ 8				
(mm)														
min		max		min		max		min		max				
P	Unalloyed steel	<600	<180	0.20	8.00	0.20	0.65	0.12	0.35	0.20	0.68	0.12	0.38	
		<950	<280			0.18	0.60	0.10	0.32	0.18	0.65	0.10	0.35	
	Alloyed steel	700-950	200-280			0.15	0.55	0.10	0.30	0.15	0.58	0.10	0.32	
		950-1200	280-355			-	-	-	-	-	-	-	-	-
1200-1400	355-415	0.15	0.50			0.10	0.30	-	-	-	-	-	-	
M	Duplex stainless steel	778	230			-	-	-	-	-	-	-	-	-
	Austenitic stainless steel	675	200			-	-	-	-	-	-	-	-	-
	Precipitation-hardening stainless steel	1013	300			-	-	-	-	-	-	-	-	-
K	Grey cast iron	700	220			-	-	-	-	-	-	-	-	-
	Nodular cast iron	880	260			-	-	-	-	-	-	-	-	-
	Malleable cast iron	800	250	-	-	-	-	-	-	-	-	-		
S	Fe-based alloy	943	280	0.15	0.50	0.10	0.30	-	-	-	-	-		
	Co-based alloy	1076	320	-	-	-	-	-	-	-	-	-		
	Ni-based alloy	1177	350	-	-	-	-	-	-	-	-	-		
	Ti-alloy	1262	370	-	-	-	-	-	-	-	-	-		
N	Aluminum	260	75	-	-	-	-	-	-	-	-	-		
	Aluminum alloy	447	130	-	-	-	-	-	-	-	-	-		
H	Hardened steel	-	50-60HRC	-	-	-	-	-	-	-	-	-		
	Chilled cast iron	-	55HRC	-	-	-	-	-	-	-	-	-		

*The recommended cutting conditions always refer to general conditions. These cutting conditions should be adjusted according to the practical machine rigidity, tools, workpiece clamping and coolants. $f_z = \frac{h_m}{\sqrt{\frac{a_e}{D_c}}}$, (calculate for $\frac{a_e}{D_c} < 30\%$)



APM00-RO20
Profile milling cutter

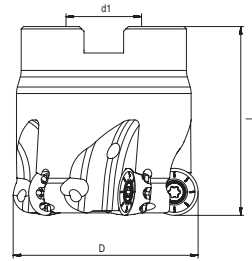

Product code	D	d1	L	l1	apmax	Internal coolant	Z	Inserts
APM00-100-Z06-A32R-RO20-C	100	32	50	-	10		6	RO 2006
APM00-125-Z07-A40R-RO20-C	125	40	63	-	10		7	
APM00-160-Z08-A40R-RO20	160	40	6	-	10		8	

Dimension(mm)	Spare parts		
Cutter diameter	Screw	Wrench	Torque
φ 100-160			7.0Nm
	SP060121	DT-TP25	

Note: With internal coolant
 Without internal coolant



Product code	Dimension(mm)		Grade						
	IC	S	AP301U	AC301P	AP351U	AP401U	AP403M	AP351K	AP403S
ROHT 2006M8E-MM3	20	6.35					●		●
ROMT 2006M8E-MR6	20	6.35					●		●

Marked : ● Stock available ○ Non-stocked standard

Materials				Cutting depth and feed											
ISO	Material classification	Tensile strength (N/mm ²)	Hardness (HB)	RO..2006..											
				ap	Geometry										
					MM3				MR6						
					fz										
					0.1 < ap ≤ 2.5		2.5 < ap ≤ 10		0.1 < ap ≤ 2.5		2.5 < ap ≤ 10				
(mm)															
min		max		min		max		min		max		min		max	
P	Unalloyed steel	<600	<180	0.20	10.00	0.20	0.70	0.15	0.38	0.20	0.80	0.15	0.40		
		<950	<280			0.18	0.65	0.12	0.35	0.18	0.70	0.12	0.38		
	Alloyed steel	700-950	200-280			0.15	0.60	0.12	0.32	0.15	0.65	0.12	0.35		
		950-1200	280-355			-	-	-	-	-	-	-	-	-	
1200-1400	355-415	0.15	0.55			0.12	0.32	-	-	-	-	-	-		
M	Duplex stainless steel	778	230			-	-	-	-	-	-	-	-	-	
	Austenitic stainless steel	675	200			-	-	-	-	-	-	-	-	-	
	Precipitation-hardening stainless steel	1013	300			-	-	-	-	-	-	-	-	-	
K	Grey cast iron	700	220			-	-	-	-	-	-	-	-	-	
	Nodular cast iron	880	260			-	-	-	-	-	-	-	-	-	
	Malleable cast iron	800	250	-	-	-	-	-	-	-	-	-			
S	Fe-based alloy	943	280	0.15	0.55	0.12	0.32	-	-	-	-	-			
	Co-based alloy	1076	320	-	-	-	-	-	-	-	-	-			
	Ni-based alloy	1177	350	-	-	-	-	-	-	-	-	-			
	Ti-alloy	1262	370	-	-	-	-	-	-	-	-	-			
N	Aluminum	260	75	-	-	-	-	-	-	-	-	-			
	Aluminum alloy	447	130	-	-	-	-	-	-	-	-	-			
H	Hardened steel	-	50-60HRC	-	-	-	-	-	-	-	-	-			
	Chilled cast iron	-	55HRC	-	-	-	-	-	-	-	-	-			

*The recommended cutting conditions always refer to general conditions. These cutting conditions should be adjusted according to the practical machine rigidity, tools, workpiece clamping and coolants. $f_z = \frac{h_m}{\sqrt{\frac{a_e}{D_c}}}$, (calculate for $\frac{a_e}{D_c} < 30\%$)



Milling cutters

AHM20-LN06

20° Approach angle high feed milling cutter

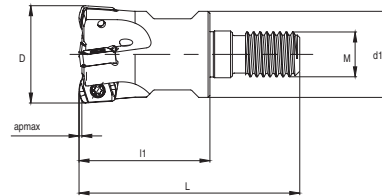
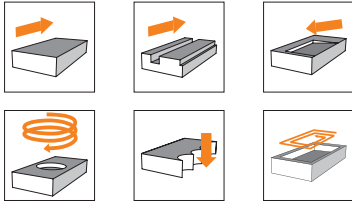

Product code	D	d1	L	L1	M	apmax	Internal coolant	Z	Inserts
AHM20-016-Z02-M08R-LN06-C	16	14.5	42	25	M8	0.8		2	LN..0604
AHM20-017-Z02-M08R-LN06-C	17	14.5	42	25	M8	0.8		2	
AHM20-020-Z03-M10R-LN06-C	20	18	51	30	M10	0.8		3	
AHM20-021-Z03-M10R-LN06-C	21	18	51	30	M10	0.8		3	
AHM20-025-Z04-M12R-LN06-C	25	23	59	35	M12	0.8		4	
AHM20-026-Z03-M12R-LN06-C	26	23	59	35	M12	0.8		3	
AHM20-026-Z04-M12R-LN06-C	26	23	59	35	M12	0.8		4	
AHM20-032-Z04-M16R-LN06-C	32	29	70	43	M16	0.8		4	
AHM20-032-Z05-M16R-LN06-C	32	29	70	43	M16	0.8		5	
AHM20-033-Z05-M16R-LN06-C	33	29	70	43	M16	0.8		5	
AHM20-035-Z05-M16R-LN06-C	35	29	70	43	M16	0.8		5	
AHM20-040-Z06-M16R-LN06-C	40	29	70	43	M16	0.8		6	

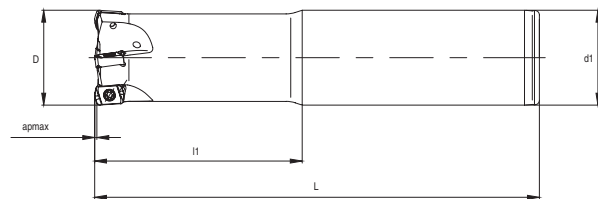

Product code	D	d1	L	L1	d2	apmax	Internal coolant	Z	Inserts
AHM20-016-Z02-C16R-LN06-L100-C	16	16	100	30	-	0.8		2	LN..0604
AHM20-017-Z02-C16R-LN06-L150-C	17	16	150	25	-	0.8		2	
AHM20-020-Z03-C20R-LN06-L130-C	20	20	130	50	-	0.8		3	
AHM20-021-Z03-C20R-LN06-L160-C	21	20	160	30	-	0.8		3	
AHM20-025-Z03-C25R-LN06-L140-C	25	25	140	60	-	0.8		3	
AHM20-026-Z03-C25R-LN06-L180-C	26	25	180	35	-	0.8		3	
AHM20-032-Z04-C32R-LN06-L150-C	32	32	150	70	-	0.8		4	
AHM20-033-Z04-C32R-LN06-L200-C	33	32	200	35	-	0.8		4	
AHM20-035-Z05-C32R-LN06-L200-C	35	32	200	35	-	0.8		5	

Note: With internal coolant
 Without internal coolant



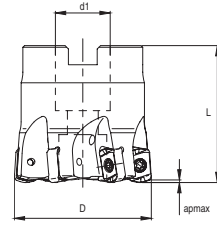

Product code	D	d1	L	L1	d2	apmax	Internal coolant	Z	Inserts
AHM20-040-Z06-A16R-LN06-C	40	16	40	-	-	0.8		6	LN..0604
AHM20-050-Z07-A22R-LN06-C	50	22	40	-	-	0.8		7	
AHM20-052-Z07-A22R-LN06-C	52	22	40	-	-	0.8		7	
AHM20-063-Z08-A22R-LN06-C	63	22	40	-	-	0.8		8	

Dimension(mm)	Spare parts		
Cutter diameter	Screw	Wrench	Torque
φ 16-63			1.0Nm
	SP02506450H	DT-TP08	

Product code	Dimension(mm)		Grades									
	Insert corner radius mm	Wiper length mm	AC301P	AP301U	AP351U	AP401U	AP403M	AC301K	AP351K	AW100K	AP403S	AP151H
LNMX 060410R-MM3	1.0	-		●	●		●				●	
LNMX 060410R-MM4	1.0	-		●	●		●				●	●

Marked : ● Stock available ○ Non-stocked standard

Materials				Cutting depth and feed											
ISO	Material classification	Tensile strength (N/mm ²)	Hardness (HB)	LNMX..0604..											
				High feed Milling			Plunging Milling								
				ap		fz		ae		fz					
				(mm)											
min		max		min		max		min		max					
P	Unalloyed steel	<600	<180	0.30	0.8	0.30	1.00	0.50	4	0.08	0.15				
		<950	<280												
	Alloyed steel	700-950	200-280									0.30	1.00	0.06	0.12
		950-1200	280-355												
M	Duplex stainless steel	778	230			0.25	0.80			0.06	0.12				
	Austenitic stainless steel	675	200												
	Precipitation-hardening stainless steel	1013	300												
K	Grey cast iron	700	220			0.30	1.00			0.08	0.15				
	Nodular cast iron	880	260												
	Malleable cast iron	800	250												
S	Fe-based alloy	943	280	0.25	0.60	0.06	0.10								
	Co-based alloy	1076	320												
	Ni-based alloy	1177	350												
	Ti-alloy	1262	370												
N	Aluminum	260	75	-	-	-	-								
	Aluminum alloy	447	130												
H	Hardened steel	-	50-60HRC	0.25	0.60	0.06	0.10								
	Chilled cast iron	-	55HRC												

Note: Please refer to P330 for programming information of high feed milling cutter

*The recommended cutting conditions always refer to general conditions. These cutting conditions should be adjusted according to the practical machine rigidity, tools, workpiece clamping and coolants. $f_z = \frac{h_m}{\sqrt{\frac{a_e}{D_c}}}$, (calculate for $\frac{a_e}{D_c} < 30\%$)

Milling cutters

AHM15-XD09

15° Approach angle high feed milling cutter

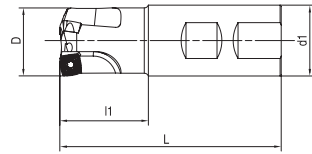
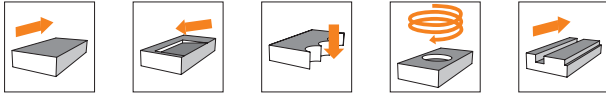

Product code	D	d1	L	l1	apmax	Internal coolant	Z	Inserts
AHM15-025-Z02-W25R-XD09-C	25	25	96	40	1.5		2	XD..0904
AHM15-032-Z03-W32R-XD09-C	32	32	100	40	1.5		3	

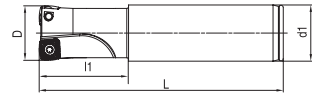

Product code	D	d1	L	l1	apmax	Internal coolant	Z	Inserts
AHM15-025-Z02-C25R-XD09-C	25	25	200	50	1.5		2	XD..0904
AHM15-026-Z02-C25R-XD09-L180-C	26	25	180	30	1.5		2	
AHM15-032-Z03-C32R-XD09-C	32	32	250	70	1.5		3	

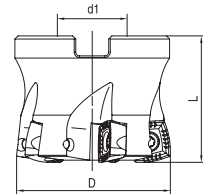
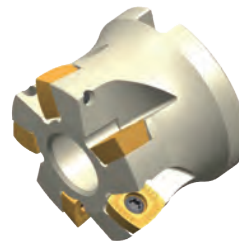

Product code	D	d1	L	l1	apmax	Internal coolant	Z	Inserts
AHM15-040-Z03-A16R-XD09-C	40	16	32	-	1.5		3	XD..0904
AHM15-040-Z04-A16R-XD09-C	40	16	32	-	1.5		4	
AHM15-040-Z05-A16R-XD09-C	40	16	32	-	1.5		5	
AHM15-050-Z05-A22R-XD09-C	50	22	40	-	1.5		5	
AHM15-050-Z06-A22R-XD09-C	50	22	40	-	1.5		6	

Dimension(mm)	Spare parts		
Cutter diameter	Screw	Wrench	Torque
φ 25-50			3.0Nm
	SP035084	DT-TP10	

Note: Please refer to P330 for programming information of high feed milling cutter

Note: With internal coolant
 Without internal coolant



Product code	Dimension(mm)		Grades						
	Insert corner radius mm	Wiper length mm	AC301P	AP301U	AP351U	AP401U	AC301K	AP351K	AW100K
XDLT 090408ER-MM3	0.8	1.3		●					
XDMW 090408ER-HR2	0.8	1.3					●		

Marked : ● Stock available ○ Non-stocked standard

Milling cutters

Materials				Cutting depth and feed											
ISO	Material classification	Tensile strength (N/mm ²)	Hardness (HB)	XD..0904..											
				High feed Milling				Plunging Milling							
				ap		fz		ae		fz					
				(mm)											
				min	max	min	max	min	max	min	max				
P	Unalloyed steel	<600	<180	0.20	1.50	0.30	1.50	0.00	7	0.05	0.15				
		<950	<280												
	Alloyed steel	700-950	200-280									0.30	1.50	0.05	0.12
		950-1200	280-355												
M	Duplex stainless steel	778	230			0.20	0.80			0.05	0.10				
	Austenitic stainless steel	675	200												
	Precipitation-hardening stainless steel	1013	300									0.10	0.40	0.05	0.08
K	Grey cast iron	700	220			0.30	1.50			0.05	0.15				
	Nodular cast iron	880	260												
	Malleable cast iron	800	250												
S	Fe-based alloy	943	280			0.10	0.50			0.05	0.10				
	Co-based alloy	1076	320												
	Ni-based alloy	1177	350												
	Ti-alloy	1262	370												
N	Aluminum	260	75	-	-	-	-								
	Aluminum alloy	447	130												
H	Hardened steel	-	50-60HRC	0.30	1.00	0.05	0.10								
	Chilled cast iron	-	55HRC												

*The recommended cutting conditions always refer to general conditions. These cutting conditions should be adjusted according to the practical machine rigidity, tools, workpiece clamping and coolants. $f_z = \frac{h_m}{\sqrt{\frac{a_e}{D_c}}}$, (calculate for $\frac{a_e}{D_c} < 30\%$)



P248

AHM15-XD12

15° Approach angle high feed milling cutter

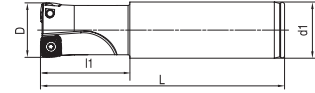
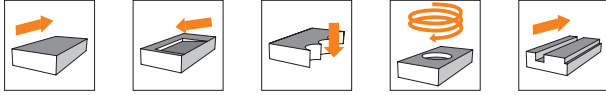

Product code	D	d1	L	l1	apmax	Internal coolant	Z	Inserts
AHM15-032-Z02-C32R-XD12-C	32	32	250	70	2.5		2	XD..1205

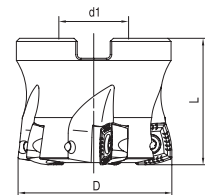
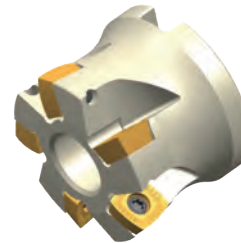

Product code	D	d1	L	l1	apmax	Internal coolant	Z	Inserts
APM00-063-Z05-A22R-RO16-C	52	22	40	-	2.5		3	XD..1205
APM00-080-Z06-A27R-RO16-C	52	22	40	-	2.5		4	
APM00-080-Z06-A27R-RO16-C	52	22	40	-	2.5		5	
APM00-063-Z05-A22R-RO16-C	63	22	40	-	2.5		4	
APM00-080-Z06-A27R-RO16-C	63	22	40	-	2.5		5	
APM00-080-Z06-A27R-RO16-C	63	22	40	-	2.5		4	
APM00-063-Z05-A22R-RO16-C	63	22	40	-	2.5		5	
APM00-080-Z06-A27R-RO16-C	66	27	45	-	2.5		4	
APM00-080-Z06-A27R-RO16-C	66	27	45	-	2.5		5	
APM00-063-Z05-A22R-RO16-C	66	27	45	-	2.5		4	
APM00-080-Z06-A27R-RO16-C	66	27	45	-	2.5		5	
APM00-080-Z06-A27R-RO16-C	80	27	50	-	2.5		5	
APM00-063-Z05-A22R-RO16-C	80	27	50	-	2.5		8	
APM00-080-Z06-A27R-RO16-C	80	27	50	-	2.5		5	
APM00-080-Z06-A27R-RO16-C	80	27	50	-	2.5		8	
APM00-063-Z05-A22R-RO16-C	100	32	50	-	2.5		6	
APM00-080-Z06-A27R-RO16-C	100	32	50	-	2.5		9	
APM00-080-Z06-A27R-RO16-C	100	32	50	-	2.5		6	
APM00-063-Z05-A22R-RO16-C	100	32	50	-	2.5		9	
APM00-080-Z06-A27R-RO16-C	125	40	63	-	2.5		8	
APM00-100-Z07-A32R-RO16-C	125	40	63	-	2.5		11	
APM00-080-Z06-A27R-RO16-C	125	40	63	-	2.5		8	
APM00-100-Z07-A32R-RO16-C	125	40	63	-	2.5		11	

Note: With internal coolant
 Without internal coolant

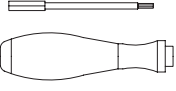

Dimension(mm)	Spare parts		
Cutter diameter	Screw	Wrench	Torque
φ 32-125			3.5Nm
	SP040112	DT-TP15	

Note: Please refer to P330 for programming information of high feed milling cutter

Product code	Dimension(mm)		Grades						
	Insert corner radius mm	Wiper length mm	AC301P	AP301U	AP351U	AP401U	AC301K	AP351K	AW100K
XDLT 120508ER-MM3	0.8	2.2	●	●	●		●	●	
XDLT 120512ER-MM3	1.2	2.2	●	●	●		●	●	
XDMW 120508ER-HR2	0.8	2.2		●			●		

Marked : ● Stock available ○ Non-stocked standard

Materials				Cutting depth and feed											
ISO	Material classification	Tensile strength (N/mm ²)	Hardness (HB)	XD..1205..											
				High feed Milling				Plunging Milling							
				ap		fz		ae		fz					
				(mm)											
min		max		min		max		min		max					
P	Unalloyed steel	<600	<180	0.50	2.50	0.30	2.00	0.00	10	0.06	0.18				
		<950	<280									0.30	2.00	0.06	0.15
	Alloyed steel	700-950	200-280												
		950-1200	280-355									0.10	0.60	0.05	0.10
1200-1400	355-415	0.30	2.00			0.05	0.12								
M	Duplex stainless steel									778	230	0.30	2.00	0.05	0.12
	Austenitic stainless steel									675	200				
	Precipitation-hardening stainless steel	1013	300			0.30	2.00			0.05	0.12				
K	Grey cast iron	700	220									0.30	2.00	0.06	0.18
	Nodular cast iron	880	260												
	Malleable cast iron	800	250			0.30	2.00			0.05	0.12				
S	Fe-based alloy	943	280									0.30	2.00	0.05	0.12
	Co-based alloy	1076	320												
	Ni-based alloy	1177	350												
	Ti-alloy	1262	370												
N	Aluminum	260	75	-	-	-	-								
	Aluminum alloy	447	130												
H	Hardened steel	-	50-60HRC	0.30	1.00	0.05	0.12								
	Chilled cast iron	-	55HRC												

*The recommended cutting conditions always refer to general conditions. These cutting conditions should be adjusted according to the practical machine rigidity, tools, workpiece clamping and coolants. $f_z = \frac{h_m}{\sqrt{\frac{a_e}{D_c}}}$, (calculate for $\frac{a_e}{D_c} < 30\%$)



Milling cutters

Milling Insert Denomination System

A
1

P
2

1- Shape/code

A	H	M	O	R
 85°	 120°	 86°	 135°	 360°
S	T	Z	X	
 90°	 60°	 86°		Special

F
3

W
4

2- Clearance angle

C 7°	D 15°	E 20°	F 25°
G 30°	N 0°	P 11°	O Other clearance angle

3- Tolerance

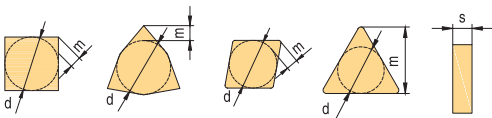

Class	Unit	In. Circle dimension d	Nose height m	Thickness s
A	mm	± 0,025	± 0,005	± 0,025
C	mm	± 0,025	± 0,013	± 0,025
E	mm	± 0,025	± 0,025	± 0,025
F	mm	± 0,013	± 0,005	± 0,025
G	mm	± 0,025	± 0,025	± 0,13
H	mm	± 0,013	± 0,013	± 0,025
J	mm	*	± 0,005	± 0,025
K	mm	*	± 0,013	± 0,025
L	mm	*	± 0,025	± 0,025
M	mm	*	*	± 0,127
U	mm	*	*	± 0,127
N	mm	*	*	± 0,025

* For details refer to right and below tables

IC	Shape: C, E, H, M, O, P, S, T, R, W			
	d		m	
	J, K, L, M, N	U	M, N	U
4.76	± 0,05	± 0,08	± 0,08	± 0,13
5.56	± 0,05	± 0,08	± 0,08	± 0,13
6	± 0,05	± 0,08	± 0,08	± 0,13
6.35	± 0,05	± 0,08	± 0,08	± 0,13
7.94	± 0,05	± 0,08	± 0,08	± 0,13
8	± 0,05	± 0,08	± 0,08	± 0,13
9.525	± 0,05	± 0,08	± 0,08	± 0,13
10	± 0,05	± 0,08	± 0,08	± 0,13
12	± 0,08	± 0,13	± 0,13	± 0,2
12.7	± 0,08	± 0,13	± 0,13	± 0,2
15.875	± 0,1	± 0,18	± 0,15	± 0,27
16	± 0,1	± 0,18	± 0,15	± 0,27
19.05	± 0,1	± 0,18	± 0,15	± 0,27
20	± 0,1	± 0,18	± 0,15	± 0,27
25	± 0,13	± 0,25	± 0,18	± 0,38
25.4	± 0,13	± 0,25	± 0,18	± 0,38
31.75	± 0,15	± 0,25	± 0,2	± 0,38
32	± 0,15	± 0,25	± 0,2	± 0,38

M&N shape	D shape		V shape	
	d	m	d	m
5.56	± 0,05	± 0,11		
6.35	± 0,05	± 0,11	± 0,05	± 0,16
7.94	± 0,05	± 0,11	± 0,05	± 0,16
9.525	± 0,05	± 0,11	± 0,05	± 0,16
12.7	± 0,08	± 0,15	± 0,08	± 0,2
15.875	± 0,10	± 0,18	± 0,10	± 0,27
19.05	± 0,10	± 0,18	± 0,10	± 0,27

4- Clamping type

A 	B 70°-90°	C 70°-90°	F 	G
H 70°-90°	J 70°-90°	M 	N 	Q 40°-60°
R 	T 40°-60°	U 40°-60°	W 40°-60°	X Special

16	04	PD					
5	6	7					
5- Cutting edge length							
In.Circle dimension (mm)	H	M	O	R	S	T	Z
3.180						05	
3.970						06	
5.000			05				
5.560						09	
6.000			06				
6.350						11	
7.940						13	
8.000			08				
9.525			09	09	16		
10.000			10				
12.000			12				
12.700		04	12	12	22		
15.875			15	15	27		
16.000		06	16				
19.050			19	19	33		
20.000			20				
25.000			25	25			
25.400			25				
31.750			31				
32.000			32				

7-Corner radius and wiper edge																	
	<table border="0"> <tr><td>00 = sharp</td><td>24 = 2.4</td></tr> <tr><td>01 = 0.1</td><td>28 = 2.8</td></tr> <tr><td>02 = 0.2</td><td>32 = 3.2</td></tr> <tr><td>04 = 0.4</td><td>40 = 4.0</td></tr> <tr><td>08 = 0.8</td><td>48 = 4.8</td></tr> <tr><td>12 = 1.2</td><td>56 = 5.6</td></tr> <tr><td>16 = 1.6</td><td>64 = 6.4</td></tr> <tr><td>20 = 2.0</td><td>X = others</td></tr> </table>	00 = sharp	24 = 2.4	01 = 0.1	28 = 2.8	02 = 0.2	32 = 3.2	04 = 0.4	40 = 4.0	08 = 0.8	48 = 4.8	12 = 1.2	56 = 5.6	16 = 1.6	64 = 6.4	20 = 2.0	X = others
00 = sharp	24 = 2.4																
01 = 0.1	28 = 2.8																
02 = 0.2	32 = 3.2																
04 = 0.4	40 = 4.0																
08 = 0.8	48 = 4.8																
12 = 1.2	56 = 5.6																
16 = 1.6	64 = 6.4																
20 = 2.0	X = others																
	Round insert:MO refers to metric dia. size																
 1 Approach angle(Entering angle) (kr) A = 45° D = 60° E = 75° F = 85° P = 90° Z = Others	 2 Clearance angle of wiper edge (n) A = 3° B = 5° C = 7° D = 15° E = 20° F = 25° G = 30° N = 0° P = 11° Z = Others																

S	R	-	FM2
8	9	-	10
6- Insert thickness			
			01=1.59mm
			T1=1.98mm
			02=2.38mm
			T2=2.78mm
			03=3.18mm
			T3=3.97mm
			04=4.76mm
			05=5.56mm
			06=6.35mm
			07=7.94mm
			09=9.52mm

8- Edge preparation		
F 	E 	T
Sharp cutting edge	Honed cutting edge	Negative land
K 	S 	P
Double negative land	Negative land +honed	Double negative land +honed

9-Hand of tool		
R 	L 	N
Right hand	Left hand	Neutral
10-Chip breakers refers to page P258		

Marked: if it has corner radius, the information needs to put between thickness and wipers.
 Example: APET 160408PDFR-FM2







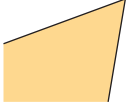

Milling inserts

Geometry Application Guide

Materials				Milling geometry application table						
				FM2	MM3	MM4	MR2	MR6	RR2	HR2
ISO	Material classification	Tensile strength (N/mm ²)	Hardness (HB)	Suitable for machining aluminium alloy	Light cutting machining	General purpose	Medium machining	Roughing machining	Heavy roughing machining	Roughing machining
P	Unalloyed steel	<600	<180	-	●	●	●	●	-	-
		<950	<280	-	●	●	●	●	-	-
	Alloyed steel	700-950	200-280	-	●	●	●	●	-	-
		950-1200	280-355	-	●	●	●	●	-	-
		1200-1400	355-415	-	●	●	●	●	-	-
M	Duplex stainless steel	778	230	-	●	●	●	-	-	-
	Austenitic stainless steel	675	200	-	●	●	●	-	-	-
	Precipitation-hardening stainless steel	1013	300	-	●	●	●	-	-	-
K	Grey cast iron	700	220	-	-	●	●	●	●	●
	Nodular cast iron	880	260	-	-	●	●	●	●	●
	Malleable cast iron	800	250	-	-	●	●	●	●	●
S	Fe-based alloy	943	280	-	●	●	●	-	-	-
	Co-based alloy	1076	320	-	●	●	●	-	-	-
	Ni-based alloy	1177	350	-	●	●	●	-	-	-
	Ti-alloy	1262	370	-	●	●	●	-	-	-
N	Aluminum	260	75	●	-	-	-	-	-	-
	Aluminum alloy	447	130	●	-	-	-	-	-	-
H	Hardened steel	-	50-60HRC	-	-	●	●	-	-	-
	Chilled cast iron	-	55HRC	-	-	●	●	-	-	-

- Best choice
- ◐ 2nd choice
- Inapplicable

Milling Geometry Introduction

Insert geometry	Edge shape	Application
FM2		<ul style="list-style-type: none"> ▪ Low cutting force, for weak machining condition ▪ Sharp geometry ▪ For aluminium material machining
MM3		<ul style="list-style-type: none"> ▪ Low cutting force, for weak machining condition ▪ Sharp geometry ▪ For steel, stainless-steel and heat resistant alloy machining.
MM4		<ul style="list-style-type: none"> ▪ For medium machining condition ▪ Universal geometry ▪ For machining most materials
MR2		<ul style="list-style-type: none"> ▪ For medium or better machining condition ▪ Universal geometry ▪ For machining most materials
MR6		<ul style="list-style-type: none"> ▪ For stable machining condition ▪ Roughing geometry ▪ For machining most materials
HR2		<ul style="list-style-type: none"> ▪ For stable machining condition ▪ Roughing geometry ▪ Mainly for cast iron machining
RR2		<ul style="list-style-type: none"> ▪ For stable machining condition ▪ Heavy roughing geometry ▪ Mainly for cast iron and steel machining
IT		<ul style="list-style-type: none"> ▪ Sharp geometry, for specified product
DT		<ul style="list-style-type: none"> ▪ Universal geometry, for specified product

Grade Application Guide

Milling grade ISO group															
Material Group	Materials	ISO	PVD	PVD	PVD	PVD	PVD	PVD	CVD	CVD	PVD	PVD	Uncoated AW100K	ISO	
			AP301U	AP351U	AP351M	AP401U	AP403S	AP403M	AC301P	AC301K	AP351K	AP151H			
P	Unalloyed steels / Alloyed steels	P01												P01	
		P05												P05	
		P10												P10	
		P15												P15	
		P20												P20	
		P25	AP301U											P25	
		P30												P30	
		P35												P35	
		P40		AP351U	AP351M	AP401U				AC301P					P40
		P45							AP403M						P45
P50													P50		
M	Stainless steels	M01												M01	
		M05												M05	
		M10												M10	
		M15												M15	
		M20												M20	
		M25	AP301U											M25	
		M30												M30	
		M35		AP351U	AP351M	AP401U	AP403S	AP403M		AC301P					M35
		M40													M40
		M45													M45
M50													M50		
K	Cast iron	K01												K01	
		K05												K05	
		K10												K10	
		K15											AP151H	K15	
		K20									AC301K			K20	
		K25										AP351K		K25	
		K30												K30	
		K35												K35	
		K40												K40	
		K45												K45	
K50												K50			
S	Heat resistant alloys	S01												S01	
		S05												S05	
		S10												S10	
		S15												S15	
		S20												S20	
		S25												S25	
		S30												S30	
		S35		AP351U	AP351M	AP401U	AP403S	AP403M							S35
		S40													S40
		S45													S45
S50													S50		
N	Aluminum/ Aluminum alloys	N01												N01	
		N05												N05	
		N10												N10	
		N15											AW100K	N15	
		N20												N20	
		N25												N25	
N30												N30			
H	Hardened steels/ Chilled cast iron	H01												H01	
		H05												H05	
		H10												H10	
		H15											AP151H	H15	
		H20												H20	
		H25												H25	
		H30												H30	

Grade Application Guide

Materials				Milling grade application										
				PVD coated						CVD coated		PVD coated		Uncoated
ISO	Material classification	Tensile strength (N/mm ²)	Hardness (HB)	AP301U	AP351U	AP351M	AP401U	AP403S	AP403M	AC301P	AC301K	AP351K	AP151H	AW100K
P	Unalloyed steel	<600	<180	●	●	●	●	●	●	●	●	-	-	-
		<950	<280	●	●	●	●	●	●	●	●	-	-	-
	Alloyed steel	700-950	200-280	●	●	●	●	●	●	●	●	-	-	-
		950-1200	280-355	●	●	●	●	●	●	●	●	-	-	-
		1200-1400	355-415	●	●	●	●	●	●	●	●	-	-	-
M	Duplex stainless steel	778	230	●	●	●	●	●	●	●	-	-	-	-
	Austenitic stainless steel	675	200	●	●	●	●	●	●	●	-	-	-	-
	Precipitation-hardening stainless steel	1013	300	●	●	●	●	●	●	●	-	-	-	-
K	Grey cast iron	700	220	-	-	-	-	-	-	-	●	●	●	-
	Nodular cast iron	880	260	-	-	-	-	-	-	-	●	●	●	-
	Malleable cast iron	800	250	-	-	-	-	-	-	-	●	●	●	-
S	Fe-based alloy	943	280	-	●	●	-	●	●	-	-	-	-	-
	Co-based alloy	1076	320	-	●	●	-	●	●	-	-	-	-	-
	Ni-based alloy	1177	350	-	●	●	-	●	●	-	-	-	-	-
	Ti-alloy	1262	370	-	●	●	-	●	●	-	-	-	-	●
N	Aluminum	260	75	-	-	-	-	-	-	-	-	-	-	●
	Aluminum alloy	447	130	-	-	-	-	-	-	-	-	-	-	●
H	Hardened steel	-	50-60HRC	-	-	-	-	-	-	-	-	-	●	-
	Chilled cast iron	-	55HRC	-	-	-	-	-	-	-	-	-	●	-

Milling inserts

- Best choice
- 2nd choice
- Inapplicable

Milling Grade Description

AP301U

Coating: PVD coating

Suitable for steel, stainless steel and high-temp alloy milling. High strength and wear resistance. Ultra fine carbide substrate with nanostructured PVD coating in controllable layer, high coating adhesion, wear-resistance and strength.

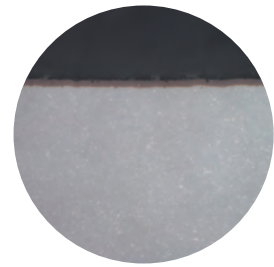

Application range												
ISO Classification	01	05	10	15	20	25	30	35	40	45	50	
P				AP301U								
M				AP301U								
K												
S												
N												
H												

Remark: Best choice
 2nd choice

AP351U

Coating: PVD coating

Suitable for steel, stainless steel and high-temp alloy semi-finishing and roughing milling. High strength carbide substrate with nanostructured PVD coating in controllable layer, high coating adhesion, wear-resistance and strength.

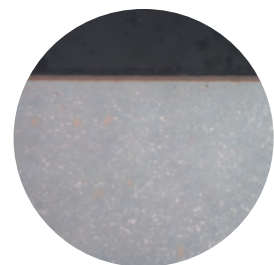

Application range												
ISO Classification	01	05	10	15	20	25	30	35	40	45	50	
P							AP351U					
M							AP351U					
K												
S							AP351U					
N												
H												

Remark: Best choice
 2nd choice

AP401U

Coating: PVD coating

Suitable for steel, stainless steel and high-temp alloy rough milling. Ultra high strength carbide substrate with nanostructured PVD coating in controllable layer, high coating adhesion, wear-resistance and strength.

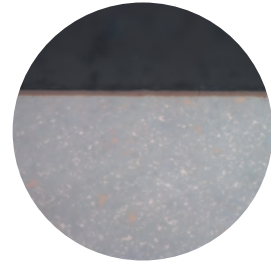

Application range												
ISO Classification	01	05	10	15	20	25	30	35	40	45	50	
P							AP401U					
M							AP401U					
K												
S							AP401U					
N												
H												

Remark: Best choice
 2nd choice

AC301P

Coating: CVD coating

Suitable for steel and stainless steel semi-finish milling. High strength carbide substrate with multi-layer CVD coating, high coating adhesion, wear resistance and surface finish quality.

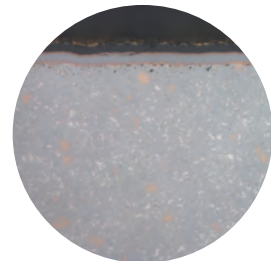

Application range											
ISO Classification	01	05	10	15	20	25	30	35	40	45	50
P						AC301P					
M						AC301P					
K											
S											
N											
H											

Remark: Best choice
 2nd choice

Milling inserts

AC301K

Coating: CVD coating

Suitable for gray and nodular cast iron finish, semi-finish and rough milling. High strength and wear resistance carbide substrate with multi-layer CVD coating, controllable coating layer structure and high adhesive strength.

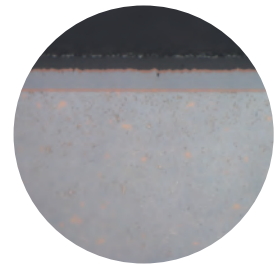

Application range											
ISO Classification	01	05	10	15	20	25	30	35	40	45	50
P											
M											
K			AC301K								
S											
N											
H											

Remark: Best choice

AP351K

Coating: PVD coating

Suitable for nodular cast iron, finish, semi-finish and rough milling. High strength and wear resistance carbide substrate with nanostructured PVD coating in controllable layer, high coating adhesion, wear resistance and oxidation resistance.

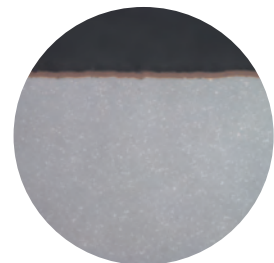

Application range											
ISO Classification	01	05	10	15	20	25	30	35	40	45	50
P											
M											
K			AP351K								
S											
N											
H											

Remark: Best choice

AW100K

Coating: Uncoated

Uncoated fine grain carbide substrate with special treated cutting edge. Suitable for nonferrous metal milling under various cutting conditions.

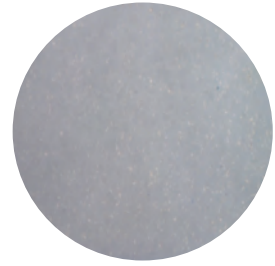

Application range											
ISO Classification	01	05	10	15	20	25	30	35	40	45	50
P											
M											
K											
S											
N			AW100K								
H											

Remark: Best choice

AP351M

Coating: PVD Coating

Suitable for steel, stainless-steel and heat resistant alloy milling, with excellent thermal-stability and wear-resistant, good thermal-crack resistance and high coating adhesion.

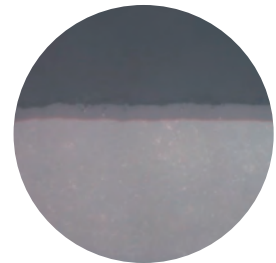

Application range											
ISO Classification	01	05	10	15	20	25	30	35	40	45	50
P						AP351M					
M						AP351M					
K											
S						AP351M					
N											
H											

Remark: Best choice

Milling inserts

AP403M

Coating: PVD Coating

Suitable for steel, stainless-steel and heat resistant alloy milling, with good wear-resistance, heat-resistance and high coating adhesion, very smooth coating surface.



Application range												
ISO Classification	01	05	10	15	20	25	30	35	40	45	50	
P								AP403M				
M								AP403M				
K												
S								AP403M				
N												
H												

Remark: Best choice

AP403S

Coating: PVD Coating

Suitable for stainless-steel and heat resistant alloy milling, with new substrate and coating combination, new substrate with high toughness, excellent hot hardness. New generation of PVD coating, with high hardness, high wear-resistance, good performance on heat-conductivity, thermal-stability, smooth surface good for reducing built-up edge.

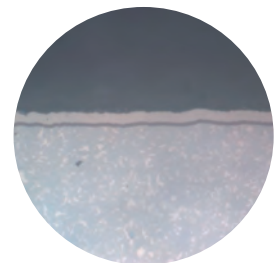

Application range												
ISO Classification	01	05	10	15	20	25	30	35	40	45	50	
P												
M								AP403S				
K												
S								AP403S				
N												
H												

Remark: Best choice

AP151H

Coating: PVD Coating

Suitable for hardened steel milling and cast iron finish milling. Ultra fine carbide substrate with high hardness and wear-resistance. Extremely hard PVD coating with good oxidation resistance, wear resistance, and thermal crack resistance.

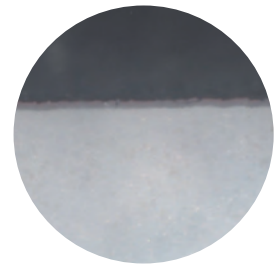

Application range											
ISO Classification	01	05	10	15	20	25	30	35	40	45	50
P											
M											
K											
S											
N											
H			AP151H								

Remark: Best choice

Milling inserts

OD..04/06

Positive octagonal milling inserts

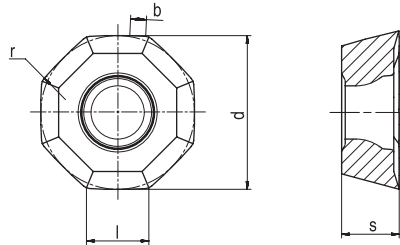

Inserts	Product code	Dimension(mm)					Grades						
		l	d	s	r	b	AP301U	AP351U	AC301P	AP401U	AC301K	AP351K	AW100K
	ODET 0404APFN-FM2	4	12.7	4.76	-	1.2							●
	ODET 0605APFN-FM2	6	16	5.56	-	1.6							●
	ODHT 0404APEN-MM3	4	12.7	4.76	-	1.2	●	●		●	●		
	ODMT 040408EN-MM3	4	12.7	4.76	0.8	-		●		●	●		
	ODMT 060508EN-MM3	6	16	5.56	0.8	-	●	●	●	●	●	●	
	ODMT 060512EN-MM3	6	16	5.56	1.2	-	●						
	ODHT 0605APEN-MM3	6	16	5.56	-	1.6	●	●		●	●		
	ODEW 0404APSR-HR2	4	12.7	4.76	-	1.2	●				●	●	
	ODEW 0605APSR-HR2	6	16	5.56	-	1.6					●	●	
	ODEW 0605APSN-HR2	6	16	5.56	-	1.6					●	●	
	ODMW 040408EN-HR2	4	12.7	4.76	0.8	-					●	●	
	ODMW 060512EN-HR2	6	16	5.56	1.2	-					●	●	

Marked : ● Stock available ○ Non-stocked standard

ON..05
Negative octagonal milling inserts

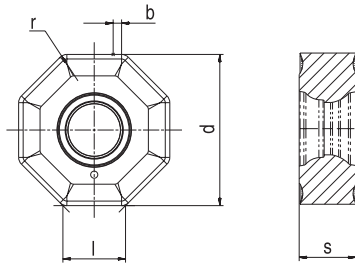

Inserts	Product code	Dimension(mm)					Grades						
		l	d	s	r	b	AP301U	AP351U	AC301P	AP401U	AC301K	AP351K	AW100K
	ONHU 050408-MM3	4.00	12.70	4.76	0.8	-	●						
	ONMU 050408-MM4	4.00	12.70	4.76	0.8	-	●	●		●	●	●	
	ONHU 050408AEN-MM3	4.00	12.70	4.76	0.8	0.7	●	●				●	
	ONHU 050408AEN-MM4	4.00	12.70	4.76	0.8	0.7		●				●	
	ONHU 0504ZNR-MM3	4.00	12.70	4.76	0.8	1.4	●						

Marked : ● Stock available ○ Non-stocked standard

Milling inserts

SC..09/12

Positive square milling inserts

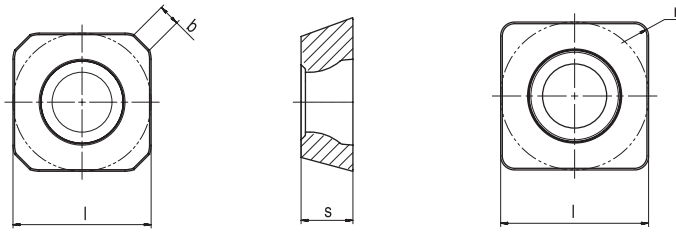





Inserts	Product code	Dimension(mm)				Grades						
		l	s	r	b	AP301U	AP351U	AC301P	AP401U	AC301K	AP351K	AW100K
	SCMT 09T304EN-MM3	9.525	3.97	0.4	-	●	●		●			
	SCMT 120412EN-MM3	12.7	4.76	1.2	-		●		●			
	SCMT 12M512EN-MM3	12.7	5	1.2	-		●		●			
	SCHT 1204ACEN-MR6	12.7	4.76	-	1.5				●		●	
	SCHT 12M5ACEN-MR6	12.7	5	-	1.5				●		●	
	SCMW 12M512EN-HR2	12.7	5	1.2	-		●				●	

Marked : ● Stock available ○ Non-stocked standard

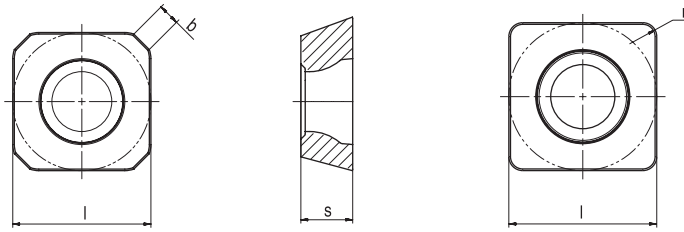
SD..09/12

Positive square milling inserts

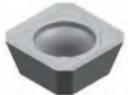

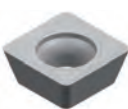
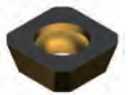
Inserts	Product code	Dimension(mm)				Grades						
		l	s	r	b	AP301U	AP351U	AC301P	AP401U	AC301K	AP351K	AW100K
	SDMT 09T304EN-MM3	9.525	3.97	0.4	-	●	●	●		●		
	SDMT 09T308EN-MM3	9.525	3.97	0.8	-	●	●	●		●		
	SDMT 09T320-MM4	9.525	3.97	2.0	-				●			
	SDMT 120408EN-MM4	12.7	4.76	0.8	-	●	●			●	●	
	SDMT 120412EN-MM3	12.7	4.76	1.2	-	●	●	●		●		
	SDGT 09T3AEEN-MM4	9.525	3.97	-	1.5	●	●			●	●	
	SDKT 1204AEEN-MR2	12.7	4.76	-	2.0	●	●	●		●	●	
	SDGT 09T3PDER-MR6	9.525	3.97	0.8	1.2	●	●			●	●	
	SDGT 1204PDER-MR6	12.7	4.76	0.8	1.6	●	●			●	●	
	SDHT 1204AEEN-MR6	12.7	4.76	0.8	2.0	●	●			●	●	
	SDMW 09T308EN-HR2	9.525	3.97	0.8	-	●				●		
	SDHW 09T3AESN-HR2	9.525	3.97	-	1.5	●				●	●	
	SDMW 120412EN-HR2	12.7	4.76	1.2	-	●				●	●	
	SDHW 1204AESN-HR2	12.7	4.76	-	2.0	●				●	●	

Marked : ● Stock available ○ Non-stocked standard

Milling inserts

SE..12

Positive square milling inserts

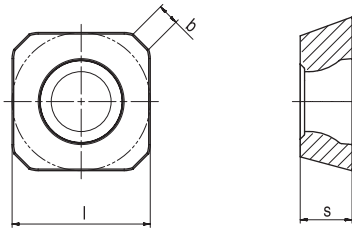

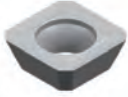
Inserts	Product code	Dimension(mm)				Grades						
		l	s	r	b	AP301U	AP351U	AC301P	AP401U	AC301K	AP351K	AW100K
	SEKT 1204AFER-MR2	12.7	4.91	1.2	1.8	●	●	●		●	●	

Marked : ● Stock available ○ Non-stocked standard

SNGX12/19

Negative short wiper milling inserts(applicable to AFM45-SN12 milling cutter)

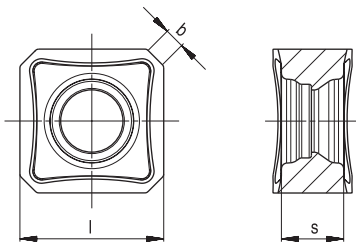

Inserts	Product code	Dimension(mm)			Grades						
		l	s	b	AP301U	AP351U	AC301P	AP401U	AC301K	AP351K	AW100K
	SNHX 1206ANN-FM2	12.7	6.98	1.8							●
	SNGX 1206ANN-MM3	12.7	6.98	1.8	●	●	●		●	●	
	SNGX 1206ANN-MM4	12.7	6.98	1.8	●	●	●		●	●	
	SNGX 1206ANN-MR6	12.7	6.98	1.8	●	●	●		●	●	
	SNGX 1206ANN-RR2	12.7	6.98	1.8	●	●	●		●	●	
	SNGX 1909ANN-MM3	19.05	9.52	2.9	●	●					
	SNGX 1909ANN-MR6	19.05	9.52	2.9		●					

Milling inserts

SNHX12

Negative long wiper milling inserts(applicable to AFM45-SN12 milling cutter)

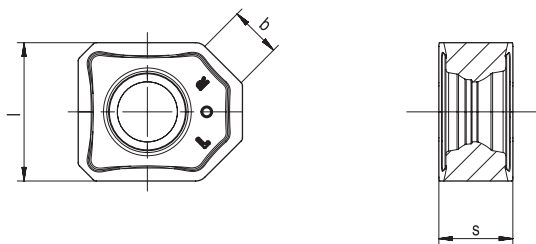

Inserts	Product code	Dimension(mm)			Grades						
		l	s	b	AP301U	AP351U	AC301P	AP401U	AC301K	AP351K	AW100K
	SNHX 1206ANN-W	12.7	6.98	6.7	●				●		

Marked : ● Stock available ○ Non-stocked standard



SNGX12

Negative short wiper milling inserts(applicable to AFM75-SN12 milling cutter)

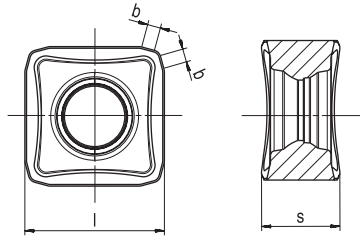

Inserts	Product code	Dimension(mm)			Grades						
		l	s	b	AP301U	AP351U	AC301P	AP401U	AC301K	AP351K	AW100K
	SNGX 1206ENN-MM3	12.7	6.98	1.2	●	●	●		●	●	
	SNGX 1206ENN-MM4	12.7	6.98	1.2	●	●	●		●	●	
	SNGX 1206ENN-MR6	12.7	6.98	1.2	●	●	●		●	●	

Marked : ● Stock available ○ Non-stocked standard

SNGX12

Negative short wiper milling inserts(applicable to AFM88-SN12 milling cutter)

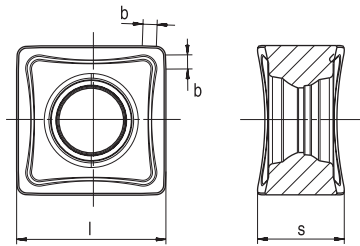

Inserts	Product code	Dimension(mm)			Grades						
		l	s	b	AP301U	AP351U	AC301P	AP401U	AC301K	AP351K	AW100K
	SNHX 1206ZNN-FM2	12.7	7.63	0.8							●
	SNGX 1206ZNN-MM4	12.7	6.98	1.2	●	●	●		●	●	
	SNGX 1206ZNN-MR6	12.7	6.98	1.2	●	●	●		●	●	
	SNGX 1206ZNN-MM3	12.7	6.98	1.2	●	●	●		●	●	

Milling inserts

SNHX12

Negative long wiper milling inserts(applicable to AFM88-SN12 milling cutter)

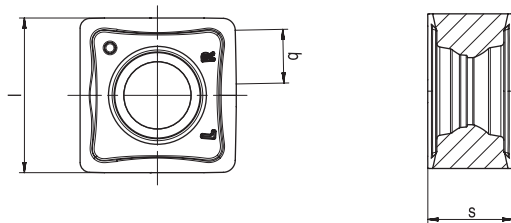

Inserts	Product code	Dimension(mm)			Grades						
		l	s	b	AP301U	AP351U	AC301P	AP401U	AC301K	AP351K	AW100K
	SNHX 1206ZNN-W	12.7	6.98	4.4	●				●		

Marked : ● Stock available ○ Non-stocked standard

SN.X12

Negative square milling inserts with corner radius

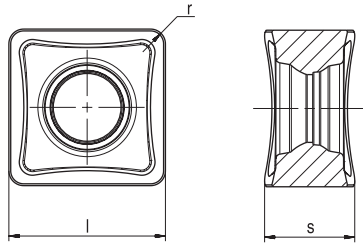

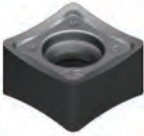
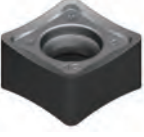



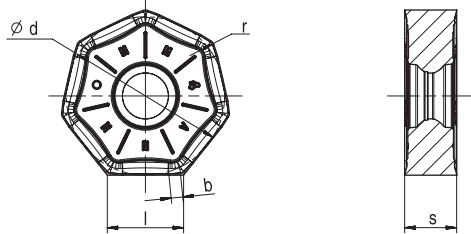

Inserts	Product code	Dimension(mm)				Grades						
		l	s	r	b	AP301U	AP351U	AC301P	AP401U	AC301K	AP351K	AW100K
	SNGX 120608-MM4	12.7	6.98	0.8	-	●	●	●		●	●	
	SNGX 120612-MM4	12.7	6.98	1.2	-	●						
	SNMX 120608-MM4	12.7	6.98	0.8	-	●	●	●		●	●	
	SNMX 120612-MM3	12.7	6.98	1.2	-	●	●	●		●	●	
	SNMX 120612-MM4	12.7	6.98	1.2	-	●	●	●		●	●	
	SNMX 120612-MR6	12.7	6.98	1.2	-	●	●	●		●	●	
	SNMX 120612-RR2	12.7	6.98	1.2	-	●	●	●		●	●	
	SNMX 120620-MM4	12.7	6.98	2.0	-	●	●	●		●	●	
	SNMX 120620-RR2	12.7	6.98	2.0	-	●	●	●		●	●	
	SNMX 1206ANN-MM3	12.7	6.98	0.4	1.8	●	●	●		●	●	
	SNMX 1206ANN-MM4	12.7	6.98	0.4	1.8	●	●	●		●	●	
	SNMX 1206ANN-MR6	12.7	6.98	0.4	1.8	●	●	●		●	●	
SNMX 1206ENN-MM4	12.7	6.98	0.8	1.2			●					

Marked : ● Stock available ○ Non-stocked standard

XN.U07/09ANN

Negative heptagonal milling inserts with short wiper



Inserts	Product code	Dimension(mm)					Grades						
		l	d	s	r	b	AP301U	AP351U	AC301P	AP401U	AC301K	AP351K	AW100K
	XNGU 0705ANN-MM3	7.0	14.5	5.4	0.8	1.1	●	●			●		
	XNGU 0705ANN-MM4	7.0	14.5	5.4	0.8	1.1	●				●		
	XNMU 0705ANN-MM4	7.0	14.5	5.4	0.8	1.1	●	●	●		●	●	
	XNMU 0705ANN-MR6	7.0	14.5	5.4	0.8	1.1	●	●			●	●	
	XNGU 0906ANN-MM3	9.2	19.0	6.25	0.8	1.4	●	●	●		●		
	XNGU 0906ANN-MM4	9.2	19.0	6.25	0.8	1.4	●	●	●		●		
	XNMU 0906ANN-MR6	9.2	19.0	6.25	0.8	1.4	●				●	●	

Marked : ● Stock available ○ Non-stocked standard

Milling inserts

XN.U 07/09

Negative heptagonal milling inserts with corner radius

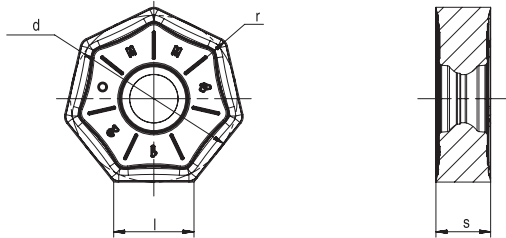

Inserts	Product code	Dimension(mm)					Grades						
		l	d	s	r	b	AP301U	AP351U	AC301P	AP401U	AC301K	AP351K	AW100K
	XNMU 070508-MM4	7.0	14.5	5.40	0.8	-		●		●	●	●	
	XNMU 090612-MM4	9.2	19.0	6.25	1.2	-	●	●		●	●	●	

XNGX 07/09ANN-W

Negative milling inserts with long wiper

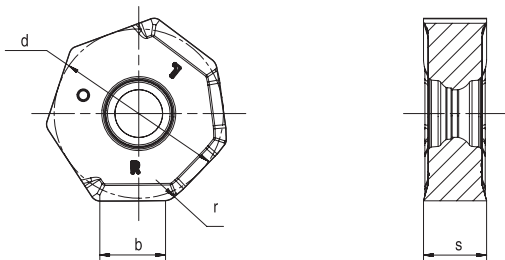

Inserts	Product code	Dimension(mm)					Grades						
		l	d	s	r	b	AP301U	AP351U	AC301P	AP401U	AC301K	AP351K	AW100K
	XNGX 0705ANN-W	-	15	5.4	1.0	6	●				●		
	XNGX 0906ANN-W	-	19.05	6.2	1.0	7.5	●				●		

Marked : ● Stock available ○ Non-stocked standard



LNHU 0904

Negative shoulder milling insert

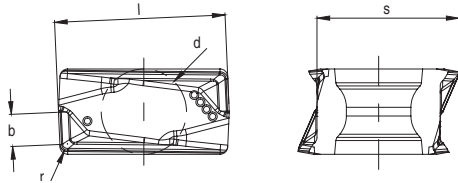

Inserts	Product code	Dimension(mm)					Grades						
		l	d	s	r	b	AP301U	AC301P	AP351U	AP403M	AC301K	AP351K	AW100K
	LNHU 090404ER-FM2	9	4.5	7.5	0.4	-							●
	LNHU 090404ER-MM3	9	4.5	7.5	0.4	-			●	●			
	LNHU 090404ER-MR2	9	4.5	7.5	0.4	-	●		●	●	●	●	
	LNHU 090408ER-MR2	9	4.5	7.45	0.8	-	●		●	●	●	●	
	LNHU 090412ER-MR2	9	4.5	7.4	1.2	-	●			●	●		
	LNHU 090416ER-MR2	9	4.5	7.35	1.6	-	●			●	●		
	LNHU 090420ER-MR2	9	4.5	7.31	2	-	●			●	●		

Wiper insert type

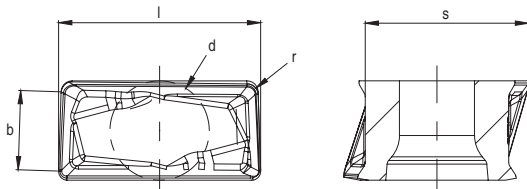

Inserts	Product code	Dimension(mm)					Grades						
		l	d	s	r	b	AP301U	AC301P	AP351U	AP403M	AC301K	AP351K	AW100K
	LNHU0904PDER-W	9.24	4.5	7.4	0.4	3.6	●					●	

Marked : ● Stock available ○ Non-stocked standard

Milling inserts

LNHU 1306...
Negative shoulder milling insert

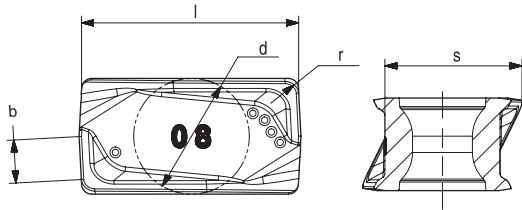

Inserts	Product code	Dimension(mm)					Grades							
		l	d	s	r	b	AP301U	AC301P	AP351U	AP401U	AC301K	AP351K	AW100K	
	LNHU 130608ER-FM2	13.02	6.8	10.11	0.8	-								●
	LNHU 130608ER-MM3	13.02	6.8	10.19	0.8	-				●				
	LNHU 130608ER-MR2	13.02	6.8	10.15	0.8	-	●	●	●	●	●	●		
	LNHU 130612ER-MR2	13.02	6.8	10.09	1.2	-			●	●	●			
	LNHU 130616ER-MR2	13.02	6.8	10.03	1.6	-			●	●	●			
	LNHU 130620ER-MR2	13.02	6.8	9.99	2.0	-			●	●				
	LNHU 130624ER-MR2	13.02	6.8	9.92	2.4	-			●	●				
	LNHU 130631ER-MR2	13.02	6.8	9.83	3.1	-			●	●	●			

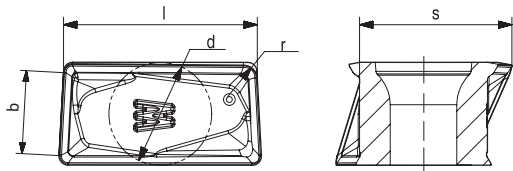

Inserts	Product code	Dimension(mm)					Grades							
		l	d	s	r	b	AP301U	AC301P	AP351U	AP401U	AC301K	AP351K	AW100K	
	LNHU 1306PDER-W	13.39	6.8	10.02	0.8	5.6	●					●		

Marked : ● Stock available ○ Non-stocked standard

LNHU 1607..
Negative shoulder milling insert

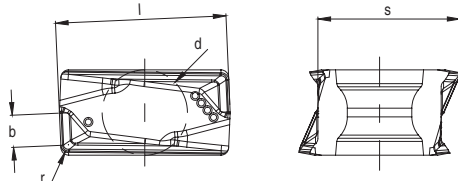

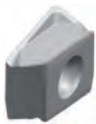
Inserts	Product code	Dimension(mm)				Grades						
		l	d	s	r	AP301U	AC301P	AP351U	AP403M	AC301K	AP351K	AW100K
	LNHU 160708ER-MR2	16	7.2	13	0.8	●		●		●	●	
	LNHU 160716ER-MR2	16	7.2	13	1.6	●				●		

Marked : ● Stock available ○ Non-stocked standard

Milling inserts

WN..08
Negative milling insert

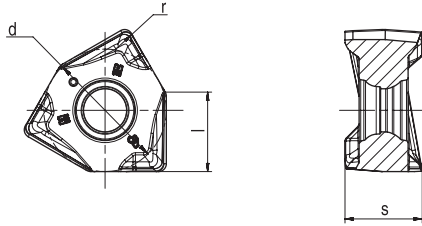

Inserts	Product code	Dimension(mm)				Grades						
		l	d	s	r	AP301U	AC301P	AP351U	AP401U	AC301K	AP351K	AW100K
	WNHU 080608R-FM2	8	12.5	7.88	0.8							●
	WNGU 080604R-MM3	8	12.5	7.88	0.4			●	●			
	WNGU 080608R-MM3	8	12.5	7.88	0.8	●		●	●			
	WNGU 080604R-MM4	8	12.5	7.88	0.4	●		●	●		●	
	WNGU 080608R-MM4	8	12.5	7.88	0.8	●	●	●	●	●	●	
	WNGU 080612R-MM4	8	12.5	7.88	1.2	●		●	●			
	WNGU 080616R-MM4	8	12.5	7.88	1.6	●		●	●			
	WNGU 080608R-MR2	8	12.5	7.88	0.8	●					●	
	WNGU 080612R-MR2	8	12.5	7.88	1.2	●					●	
	WNGU 080616R-MR2	8	12.5	7.88	1.6	●					●	

WNGU 08
Negative wiper milling insert

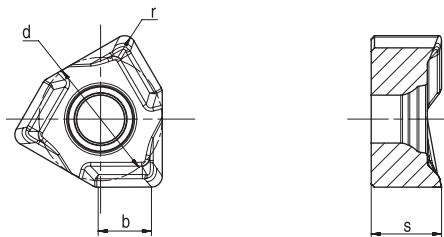



Inserts	Product code	Dimension(mm)				Grades						
		b	d	s	r	AP301U	AC301P	AP351U	AP401U	AC301K	AP351K	AW100K
	WNHX 0806ZZR-W	11.3	4.8	6.47	1	●				●		

Marked : ● Stock available ○ Non-stocked standard

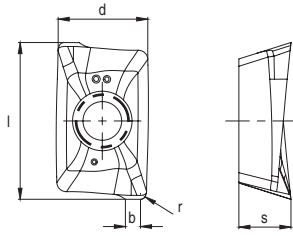

APKT 1003PDER-IT..
Positive shoulder milling insert





Inserts	Product code	Dimension(mm)					Grades						
		l	d	s	r	b	AP301U	AC301P	AP351U	AP401U	AC301K	AP351K	AP403S
	APKT 1003PDER-IT	11.35	6.66	3.77	0.8	1.08	●		●	●			●

Marked : ● Stock available ○ Non-stocked standard

Milling inserts

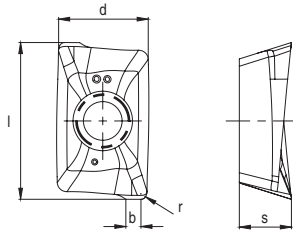
APKT 1705...-DT..
Positive shoulder milling insert





Inserts	Product code	Dimension(mm)					Grades						
		l	d	s	r	b	AP301U	AC301P	AP351U	AP401U	AC301K	AP351K	AP403S
	APKT 1705PER-DT	18.04	10.76	5.56	0.8	2.16		●	●	●		●	●

Marked : ● Stock available ○ Non-stocked standard

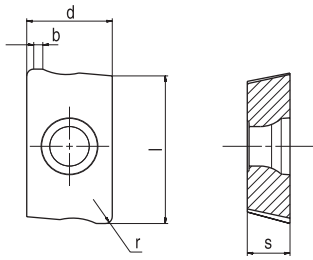
APMT..
Positive shoulder milling inserta





Inserts	Product code	Dimension(mm)					Grades						
		l	d	s	r	b	AP301U	AC301P	AP351U	AP401U	AC301K	AP351K	AP403S
	APMT 1135PDER	11.31	6.26	3.5	0.8	1.25	●		●				●
	APMT 1604PDER	17.32	9.37	5.17	0.8	1.54	●		●				

Marked : ● Stock available ○ Non-stocked standard

Milling inserts

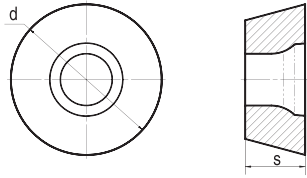
RD/RP
Round inserts

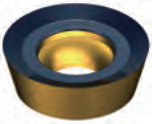
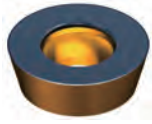
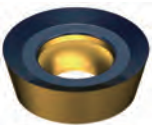
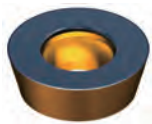

Inserts	Product code	Dimension(mm)		Grades						
		d	s	AP301U	AC301P	AP351U	AP401U	AC301K	AP351K	AP151H
	RDHT 0702MOE-MM3	7	2.38	●						
	RDHT 1003MOE-MM3	10	3.18	●						
	RDHT 12T3MOE-MM3	12	3.97	●	●	●				
	RDHT 1606MOE-MM3	16	6.35	●	●	●				
	RDHT 1604MOE-MM3	16	4.76	●		●				
	RDHW 0702MOS-HR2	7	2.38	●	●	●		●	●	
	RDHW 1003MOS-HR2	10	3.18	●	●	●		●	●	
	RDHW 12T3MOS-HR2	12	3.97	●	●	●		●	●	
	RDHW 1606MOS-HR2	16	6.35	●					●	
	RDMT 0702MOE-MM3	7	2.38	●	●					
	RDMT 1003MOE-MM3	10	3.18	●	●	●				
	RDMT 12T3MOE-MM3	12	3.97	●	●					
	RDMT 1606MOE-MM3	16	6.35	●	●					
	RDMT 1604MOE-MM3	16	4.76		●					
	RDMW 1204MOE-HR2	12	4.76	●		●				
	RDMW 1606MOE-HR2	16	6.35					●		
	RPMW 1003MOE-HR2	10	3.18	●		●				●
	RPMW 10T3MOE-HR2	10	3.97	●		●				●
	RPMT 1204MOE	12	4.76	●		●				●

Marked : ● Stock available ○ Non-stocked standard

RPM ...MM4
Copy milling insert

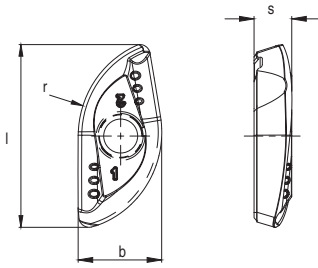



Inserts	Product code	Dimension(mm)				Grades							
		l	b	s	r	AP301U	AC301P	AP351U	AP401U	AP351M	AC301K	AP351K	AP403S
	RPM 080ER-MM4	14.76	6.89	3.21	8				●	●			●
	RPM 100ER-MM4	18.85	8.62	3.89	10				●	●			●

Marked : ● Stock available ○ Non-stocked standard

Milling inserts

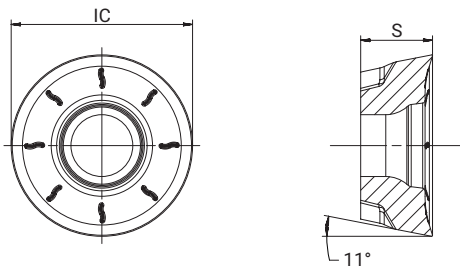
RO..T
Round inserts





Inserts	Product code	Dimension(mm)		Grades						
		IC	S	AP301U	AC301P	AP351U	AP403M	AC301K	AP351K	AP403S
	ROHT 0803M0E-MM3	8	3.18				●			●
	ROHT 10T3M8E-MM3	10	3.97				●			●
	ROHT 1204M4E-MM3	12	4.76				●			●
	ROHT 1204M6E-MM3	12	4.76				●			●
	ROHT 1605M8E-MM3	16	5.56				●			●
	ROHT 2006M8E-MM3	20	6.35				●			●
	ROMT 10T3M4E-MR6	10	3.97				●			●
	ROMT 1204M6E-MR6	12	4.76				●			●
	ROMT 1605M6E-MR6	16	5.56				●			●
	ROMT 2006M8E-MR6	20	6.35				●			●

Marked : ● Stock available ○ Non-stocked standard

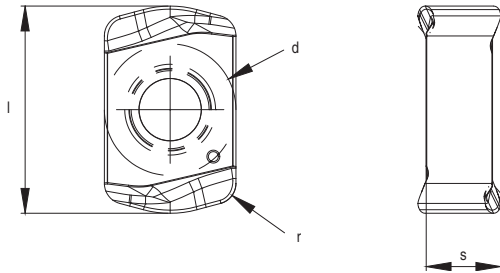
LN..06
High feed milling inserts



Inserts	Product code	Dimension(mm)				Grades									
		l	d	s	r	AC301P	AP301U	AP351U	AP401U	AP403M	AC301K	AP351K	AW100K	AP403S	AP151H
	LNMX 060410R-MM3	10	6.35	3.6	1.0		●	●		●				●	
	LNMX 060410R-MM4N	10	6.35	3.6	1.0		●	●		●				●	●

Marked : ● Stock available ○ Non-stocked standard

Milling inserts

XD..09/12

High feed milling inserts

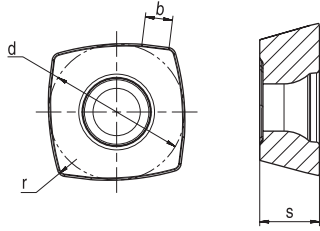

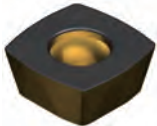

Inserts	Product code	Dimension(mm)				Grades						
		d	s	r	b	AC301P	AP301U	AP351U	AP401U	AC301K	AP351K	AW100K
	XDLT 090408ER-MM3	9.525	4.76	0.8	1.3		●					
	XDLT 120508ER-MM3	12.7	5.56	0.8	2.2	●	●	●		●	●	
	XDLT 120512ER-MM3	12.7	5.56	1.2	2.2	●	●	●		●	●	
	XDMW 090408ER-HR2	9.525	4.76	0.8	1.3					●		
	XDMW 120508ER-HR2	12.7	5.56	0.8	2.2		●			●		

Marked : ● Stock available ○ Non-stocked standard

ON05/LN12/LN15

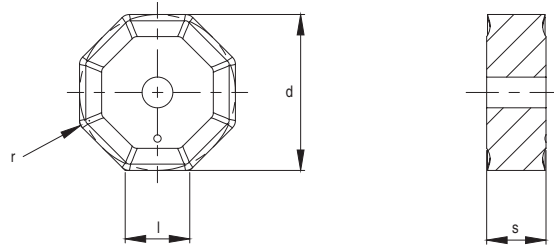
Cast iron finishing machining inserts



Inserts	Product code	Dimension(mm)				Grades
		l	d	s	r	AP151H
	ONHF 050408-MM3	5.3	12.7	4.8	0.8	●

LN12

Cast iron finishing wiper insert

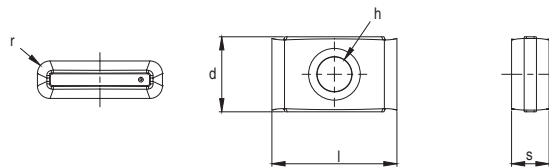

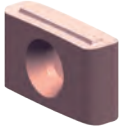
Inserts	Product code	Dimension(mm)					Grades
		l	d	s	r	H	AP151H
	LNHQ 120408FN-W	12.7	9.525	4.76	0.8	4.2	●

LN15

Cast iron finishing wiper insert

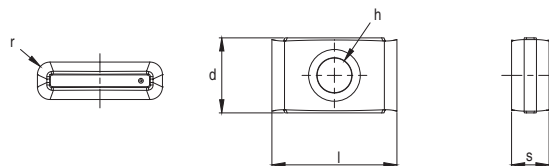

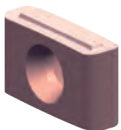
Inserts	Product code	Dimension(mm)					Grades
		l	d	s	r	H	AP151H
	LNHQ 150416FN-W	15.875	9.525	4.76	1.6	4.2	●

Marked : ● Stock available ○ Non-stocked standard



Milling inserts

Cutting Parameter Recommendation Table

Materials																		
ISO	Material classification		Brinell hardness (HB)	Tensile strength Rm(N/mm ²)	AP301U			AC301P			AP351U			AP351M				
					PVD			CVD			PVD			PVD				
					P15-P35			P25-40			P30-P45			P25-P45				
M15-M35			-			M30-M45			M25-M45			-						
-			-			S30-S45			-			S25-S45						
-			-			-			-			-						
-			-			-			-			-						
					1/10	1/5	1/1	1/10	1/5	1/1	1/10	1/5	1/1	1/10	1/5	1/1		
P	Unalloyed steel	C ≤ 0.25%	Annealed	125	428	320	280	240	380	300	260	280	240	200				
		0.25 < C ≤ 0.55%	Annealed	190	639	290	240	200	350	250	220	250	210	170				
		0.25 < C ≤ 0.55%	Heat-treated	210	708	260	210	170	310	220	190	230	180	140				
		C > 0.55%	Annealed	190	639	290	240	200	350	250	220	250	210	170				
		C > 0.55%	Heat-treated	300	1013	210	170	130	250	170	150	160	130	100				
	Low-alloyed steel	Free cutting steel (short-chip)	Annealed		220	745	250	200	160	300	210	180	220	170	130			
			Heat-treated		175	591	290	250	200	340	300	250	270	230	180			
			Heat-treated		300	1013	250	210	160	290	250	200	230	190	140			
			Heat-treated		380	1282	230	190	140	250	210	160	210	170	120			
	High-alloyed steel and high-alloyed tool steel	Heat-treated		430	1477	190	150	110	210	170	130	170	130	90				
Annealed		200	675	220	190	160	240	210	180	200	170	140						
Hardened and tempered		300	1013	170	140	110	190	160	130	150	130	90						
Stainless steel	Hardened and tempered		400	1361	150	120	90	160	130	100	130	100	70					
	Ferritic/martensitic, annealed		200	675	190	160	130	200	170	140	160	140	110	180	150	120		
	Martensitic, heat-treated		330	1114	160	120	90	170	140	110	140	110	80	150	120	90		
M	Stainless steel	Austenitic, quench hardened		200	675	180	150	120				170	140	110	170	150	120	
		Austenitic, precipitation hardened (PH)		300	1013	160	130	100				150	120	90	150	130	100	
		Austenitic/ferritic, duplex		230	778	170	140	110				160	130	100	160	140	110	
K	Malleable cast iron	Ferritic		200	400													
		Pearlitic		260	700													
	Grey cast iron	Low tensile strength		180	200													
		High tensile strength/austenitic		245	350													
	Nodular cast iron	Ferritic		155	400													
		Pearlitic		265	700													
GGV(CGI)				230	400													
N	Wrought aluminium alloys	Non-aging		30	-													
		Aged		100	340													
	Cast aluminium alloys	≤ 12% Si, non-aging		75	260													
		≤ 12% Si, aged		90	310													
	> 12% Si, non-aging		130	450														
	Magnesium alloys				70	250												
	Copper and copper alloys	Unalloyed, electrolytic copper				100	340											
Brass, bronze, red brass				90	310													
Cu alloys, short-chipping				110	380													
High-tensile, Ampco alloy				300	1010													
S	Heat-resistant alloys	Fe-based	Annealed		200	680					90	80	70	100	90	80		
			Hardened		280	940					75	60	50	80	70	60		
		Ni or Co based	Annealed		250	840					80	55	45	70	60	50		
			Hardened		350	1180					60	50	35	60	50	40		
	Cast				320	1080					60	55	40	65	55	45		
	Titanium alloys	Pure titanium				200	680					110	90	80	120	100	90	
		α and β alloys, hardened				375	1260					50	40	30	55	45	35	
		β alloys				410	1400					50	40	30	55	45	35	
Tungsten alloys		1177		300	1010					65	60	50	70	65	55			
Molybdenum alloys		1262		300	1010					65	60	50	70	65	55			
H	Hardened steel	Hardened and tempered		50HRC														
		Hardened and tempered		55HRC														
		Hardened and tempered		60HRC														
	Hardened cast steel		Hardened and tempered		50HRC													

Milling grade application range																					
AP403M		AP401U		AP403S		AC301K		AP351K		AP151H		AW100K									
PVD		PVD		PVD		CVD		PVD		PVD		Uncoated									
P35-P50		P30-P50		-		-		-		-		-									
M35-M50		M30-M50		M35-M50		-		-		-		-									
-		-		-		K10-K35		K15-K40		K15-K40		-									
S35-S50		-		S35-S50		-		-		-		-									
-		-		-		-		-		-		N10-N20									
-		-		-		H10-H20		-		H10-H20		-									
according to the value of ae/Dc																					
1/10	1/5	1/1	1/10	1/5	1/1	1/10	1/5	1/1	1/10	1/5	1/1	1/10	1/5	1/1	1/10	1/5	1/1	1/10	1/5	1/1	
Cutting speed (m/min)																					
[Blue grid area]																					
170	140	110	160	140	110																
140	110	80	140	110	80																
160	140	110	160	140	110	190	160	140													
140	120	90	150	130	90	170	140	120													
150	130	100	150	130	100	160	130	110													
[Red grid area]																					
								240		210		180		220		190		160		180	
								220		190		160		200		170		140		160	
								280		250		220		260		230		200		210	
								240		210		180		210		190		160		180	
								260		230		200		240		210		180		190	
								190		160		130		170		140		110		150	
								200		170		140		180		150		120		160	
																		2200		2200	
																		1800		1800	
																		600		600	
																		500		500	
																		280		280	
																		400		400	
																		300		300	
																		200		200	
[Brown grid area]																					
95	85	75					110	100	90												
80	65	55					90	80	70												
85	60	50					80	70	60												
65	55	35					75	65	50												
65	60	45					75	65	55												
120	95	85					120	100	90												
50	40	30					60	50	40												
50	40	30					60	50	40												
70	60	50					70	65	60												
70	60	50					70	65	60												
[Light Blue grid area]																					
								70		60		50						65		55	
																		60		50	
																		60		50	

Milling inserts

ACHTTECK

www.achtecktool.com

ACHTTECK
HP-3D220-S32-S07



CUTTING TOOL CATALOGUE

Drilling holders	250
Drilling holder denomination system	253
Drilling holder	254
Drilling inserts	266
Drilling insert denomination system	266
Geometry application guide	268
Grade application guide	269
Drilling grade description	271
Drilling inserts	273
Cutting parameter recommendation	276
Deep hole drilling product introduction	278
Deep hole drilling inserts	279
Cutting parameter recommendation	284

ACHTTECK

www.achtecktool.com



Drill holders

Drilling Holder Denomination System

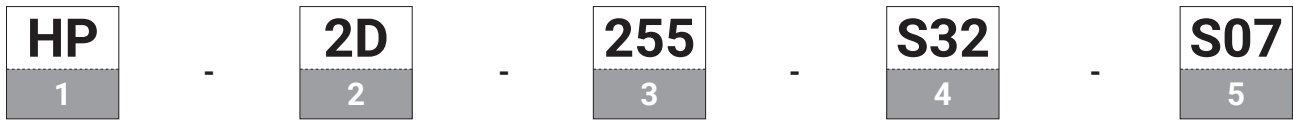



1	HP	Machining method	Represent for high productivity machining			
2	2D	Length-diameter ratio	2D, 3D, 4D,			
3	255	Tool diameter	255-25.5mm, 500-50mm			
4	S32	Shank diameter	S20=20mm	S25=25mm	S32=32mm	S40=40mm
5	S07	Inserts shape and edge length	If the insert shape is "S", it means the cutting edge length is 7mm, if the insert shape is "W", the code is "W07"			

DP Series Drilling Holder

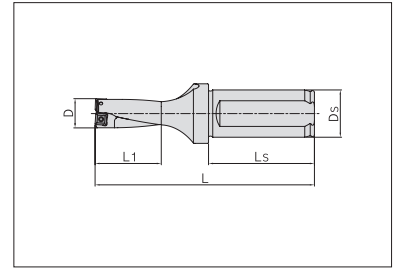
Length-diameter ratio: 2D

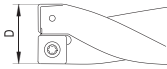

Product code	Dimension(mm)					Inserts
	D	L ₁	L	D _s	L _s	
HP-2D130-S20-S05	13.0	29	99	20	50	SPMT050204E-DP
HP-2D135-S20-S05	13.5	30	100	20	50	
HP-2D140-S20-S05	14.0	31	101	20	50	
HP-2D145-S20-S05	14.5	32	102	20	50	
HP-2D150-S20-S05	15.0	33	103	20	50	
HP-2D155-S25-S06	15.5	34	115	25	56	SPMT060204E-DP
HP-2D160-S25-S06	16.0	35	116	25	56	
HP-2D165-S25-S06	16.5	36	117	25	56	
HP-2D170-S25-S06	17.0	37	118	25	56	
HP-2D175-S25-S06	17.5	38	119	25	56	
HP-2D180-S25-S06	18.0	39	120	25	56	
HP-2D185-S25-S06	18.5	40	121	25	56	
HP-2D190-S25-S06	19.0	41	122	25	56	
HP-2D195-S25-S06	19.5	42	123	25	56	
HP-2D200-S25-S06	20.0	43	124	25	56	
HP-2D205-S25-S06	20.5	44	125	25	56	
HP-2D210-S25-S06	21.0	45	126	25	56	
HP-2D215-S25-S06	21.5	46	127	25	56	
HP-2D220-S32-S07	22.0	47	137	32	60	SPMT07T308E-DP
HP-2D225-S32-S07	22.5	48	138	32	60	
HP-2D230-S32-S07	23.0	49	139	32	60	
HP-2D235-S32-S07	23.5	50	140	32	60	
HP-2D240-S32-S07	24.0	51	141	32	60	
HP-2D245-S32-S07	24.5	52	142	32	60	
HP-2D250-S32-S07	25.0	53	143	32	60	
HP-2D255-S32-S07	25.5	54	144	32	60	
HP-2D260-S32-S07	26.0	55	145	32	60	
HP-2D265-S32-S07	26.5	56	146	32	60	
HP-2D270-S32-S07	27.0	57	147	32	60	
HP-2D275-S32-S07	27.5	58	148	32	60	

Dimensions (mm)	Spare parts	
Holder diameter	Screw	Wrench
		
13-15	AST2043-60	AWF-T06
15.5-21.5	AST2255-60	AWF-T06
22-27.5	AST25065-60S	AWF-T08



P273



P276

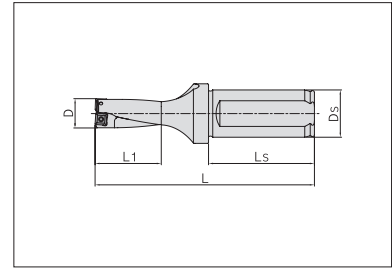

DP Series Drilling Holder

Length-diameter ratio: 2D

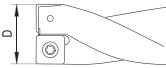

Product code	Dimension(mm)					Inserts
	D	L ₁	L	D _s	L _s	
HP-2D280-S32-S09	28.0	59	149	32	60	SPMT090408E-DP
HP-2D285-S32-S09	28.5	60	150	32	60	
HP-2D290-S32-S09	29.0	61	151	32	60	
HP-2D295-S32-S09	29.5	63	153	32	60	
HP-2D300-S32-S09	30.0	65	155	32	60	
HP-2D310-S32-S09	31.0	67	157	32	60	
HP-2D320-S32-S09	32.0	69	159	32	60	
HP-2D330-S32-S09	33.0	71	161	32	60	
HP-2D340-S40-S11	34.0	73	178	40	70	SPMT110408E-DP
HP-2D350-S40-S11	35.0	75	180	40	70	
HP-2D360-S40-S11	36.0	77	182	40	70	
HP-2D370-S40-S11	37.0	79	184	40	70	
HP-2D380-S40-S11	38.0	81	186	40	70	
HP-2D390-S40-S11	39.0	83	188	40	70	
HP-2D400-S40-S11	40.0	85	190	40	70	
HP-2D410-S40-S11	41.0	87	192	40	70	
HP-2D420-S40-S14	42.0	89	194	40	70	SPMT140512E-DP
HP-2D430-S40-S14	43.0	91	196	40	70	
HP-2D440-S40-S14	44.0	93	198	40	70	
HP-2D450-S40-S14	45.0	95	200	40	70	
HP-2D460-S40-S14	46.0	97	202	40	70	
HP-2D470-S40-S14	47.0	99	204	40	70	
HP-2D480-S40-S14	48.0	101	206	40	70	
HP-2D490-S40-S14	49.0	103	208	40	70	
HP-2D500-S40-S14	50.0	105	210	40	70	

Drilling holders



Dimensions (mm)	Spare parts	
Holder diameter	Screw	Wrench
		
28-33	AST35084-60H	AWF-T15
34-41	AST410-60H	AWF-T15
42-50	AST5126-60	AWF-T20

DP Series Drilling Holder

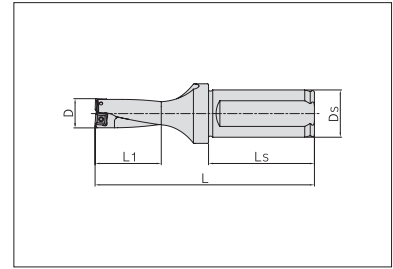
Length-diameter ratio: 3D

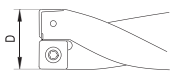

Product code	Dimension(mm)					Inserts
	D	L ₁	L	D _s	L _s	
HP-3D130-S20-S05	13.0	42	112	20	50	SPMT050204E-DP
HP-3D135-S20-S05	13.5	44	114	20	50	
HP-3D140-S20-S05	14.0	45	115	20	50	
HP-3D145-S20-S05	14.5	47	117	20	50	
HP-3D150-S20-S05	15.0	48	118	20	50	
HP-3D155-S25-S06	15.5	50	131	25	56	SPMT060204E-DP
HP-3D160-S25-S06	16.0	51	132	25	56	
HP-3D165-S25-S06	16.5	53	134	25	56	
HP-3D170-S25-S06	17.0	54	135	25	56	
HP-3D175-S25-S06	17.5	56	137	25	56	
HP-3D180-S25-S06	18.0	57	138	25	56	
HP-3D185-S25-S06	18.5	59	140	25	56	
HP-3D190-S25-S06	19.0	60	141	25	56	
HP-3D195-S25-S06	19.5	62	143	25	56	
HP-3D200-S25-S06	20.0	63	144	25	56	
HP-3D205-S25-S06	20.5	65	146	25	56	
HP-3D210-S25-S06	21.0	66	147	25	56	
HP-3D215-S25-S06	21.5	68	149	25	56	
HP-3D220-S32-S07	22.0	69	159	32	60	SPMT07T308E-DP
HP-3D225-S32-S07	22.5	71	161	32	60	
HP-3D230-S32-S07	23.0	72	162	32	60	
HP-3D235-S32-S07	23.5	74	164	32	60	
HP-3D240-S32-S07	24.0	75	165	32	60	
HP-3D245-S32-S07	24.5	77	167	32	60	
HP-3D250-S32-S07	25.0	78	168	32	60	
HP-3D255-S32-S07	25.5	80	170	32	60	
HP-3D260-S32-S07	26.0	81	171	32	60	
HP-3D265-S32-S07	26.5	83	173	32	60	
HP-3D270-S32-S07	27.0	84	174	32	60	
HP-3D275-S32-S07	27.5	86	176	32	60	

Dimensions (mm)	Spare parts	
Holder diameter	Screw	Wrench
		
13-15	AST2043-60	AWF-T06
15.5-21.5	AST2255-60	AWF-T06
22-27.5	AST25065-60S	AWF-T08



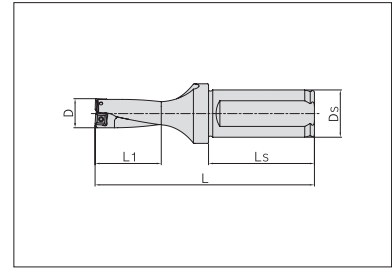

DP Series Drilling Holder

Length-diameter ratio: 3D

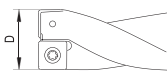

Product code	Dimension(mm)					Inserts
	D	L ₁	L	D _s	L _s	
HP-3D280-S32-S09	28.0	87	177	32	60	SPMT090408E-DP
HP-3D285-S32-S09	28.5	89	179	32	60	
HP-3D290-S32-S09	29.0	90	180	32	60	
HP-3D295-S32-S09	29.5	93	183	32	60	
HP-3D300-S32-S09	30.0	95	185	32	60	
HP-3D310-S32-S09	31.0	98	188	32	60	
HP-3D320-S32-S09	32.0	101	191	32	60	
HP-3D330-S32-S09	33.0	104	194	32	60	
HP-3D340-S40-S11	34.0	107	212	40	70	SPMT110408E-DP
HP-3D350-S40-S11	35.0	110	215	40	70	
HP-3D360-S40-S11	36.0	113	218	40	70	
HP-3D370-S40-S11	37.0	116	221	40	70	
HP-3D380-S40-S11	38.0	119	224	40	70	
HP-3D390-S40-S11	39.0	122	227	40	70	
HP-3D400-S40-S11	40.0	125	230	40	70	
HP-3D410-S40-S11	41.0	128	233	40	70	
HP-3D420-S40-S14	42.0	131	236	40	70	SPMT140512E-DP
HP-3D430-S40-S14	43.0	134	239	40	70	
HP-3D440-S40-S14	44.0	137	242	40	70	
HP-3D450-S40-S14	45.0	140	245	40	70	
HP-3D460-S40-S14	46.0	143	248	40	70	
HP-3D470-S40-S14	47.0	146	251	40	70	
HP-3D480-S40-S14	48.0	149	254	40	70	
HP-3D490-S40-S14	49.0	152	257	40	70	
HP-3D500-S40-S14	50.0	155	260	40	70	

Drilling holders



Dimensions (mm)	Spare parts	
Holder diameter	Screw	Wrench
		
28-33	AST35084-60H	AWF-T15
34-41	AST410-60H	AWF-T15
42-50	AST5126-60	AWF-T20

DP Series Drilling holder

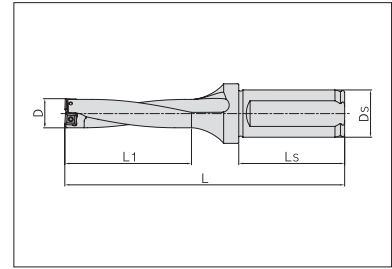
Length-diameter ratio: 4D

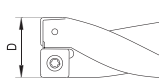

Product code	Dimension(mm)					Inserts
	D	L ₁	L	D _s	L _s	
HP-4D130-S20-S05	13.0	55	125	20	50	SPMT050204E-DP
HP-4D135-S20-S05	13.5	57	127	20	50	
HP-4D140-S20-S05	14.0	59	129	20	50	
HP-4D145-S20-S05	14.5	61	131	20	50	
HP-4D150-S20-S05	15.0	63	133	20	50	
HP-4D155-S25-S06	15.5	65	146	25	56	SPMT060204E-DP
HP-4D160-S25-S06	16.0	67	148	25	56	
HP-4D165-S25-S06	16.5	69	150	25	56	
HP-4D170-S25-S06	17.0	71	152	25	56	
HP-4D175-S25-S06	17.5	73	154	25	56	
HP-4D180-S25-S06	18.0	75	156	25	56	
HP-4D185-S25-S06	18.5	77	158	25	56	
HP-4D190-S25-S06	19.0	79	160	25	56	
HP-4D195-S25-S06	19.5	81	162	25	56	
HP-4D200-S25-S06	20.0	83	164	25	56	
HP-4D205-S25-S06	20.5	85	166	25	56	
HP-4D210-S25-S06	21.0	87	168	25	56	
HP-4D215-S25-S06	21.5	89	170	25	56	
HP-4D220-S32-S07	22.0	91	181	32	60	SPMT07T308E-DP
HP-4D225-S32-S07	22.5	93	183	32	60	
HP-4D230-S32-S07	23.0	95	185	32	60	
HP-4D235-S32-S07	23.5	97	187	32	60	
HP-4D240-S32-S07	24.0	99	189	32	60	
HP-4D245-S32-S07	24.5	101	191	32	60	
HP-4D250-S32-S07	25.0	103	193	32	60	
HP-4D255-S32-S07	25.5	105	195	32	60	
HP-4D260-S32-S07	26.0	107	197	32	60	
HP-4D265-S32-S07	26.5	109	199	32	60	
HP-4D270-S32-S07	27.0	111	201	32	60	
HP-4D275-S32-S07	27.5	113	203	32	60	

Dimensions (mm)	Spare parts	
Holder diameter	Screw	Wrench
		
13-15	AST2043-60	AWF-T06
15.5-21.5	AST2255-60	AWF-T06
22-27.5	AST25065-60S	AWF-T08



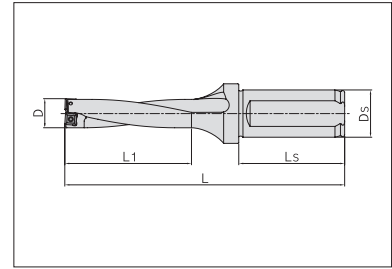

DP Series Drilling holder

Length-diameter ratio: 4D

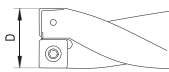

Product code	Dimension(mm)					Inserts
	D	L ₁	L	D _s	L _s	
HP-4D280-S32-S09	28.0	115	205	32	60	SPMT090408E-DP
HP-4D285-S32-S09	28.5	117	207	32	60	
HP-4D290-S32-S09	29.0	120	210	32	60	
HP-4D295-S32-S09	29.5	123	213	32	60	
HP-4D300-S32-S09	30.0	125	215	32	60	
HP-4D310-S32-S09	31.0	129	219	32	60	
HP-4D320-S32-S09	32.0	133	223	32	60	
HP-4D330-S32-S09	33.0	137	227	32	60	
HP-4D340-S40-S11	34.0	141	246	40	70	SPMT110408E-DP
HP-4D350-S40-S11	35.0	145	250	40	70	
HP-4D360-S40-S11	36.0	149	254	40	70	
HP-4D370-S40-S11	37.0	153	258	40	70	
HP-4D380-S40-S11	38.0	157	262	40	70	
HP-4D390-S40-S11	39.0	161	266	40	70	
HP-4D400-S40-S11	40.0	165	270	40	70	
HP-4D410-S40-S11	41.0	169	274	40	70	
HP-4D420-S40-S14	42.0	173	278	40	70	SPMT140512E-DP
HP-4D430-S40-S14	43.0	177	282	40	70	
HP-4D440-S40-S14	44.0	181	286	40	70	
HP-4D450-S40-S14	45.0	185	290	40	70	
HP-4D460-S40-S14	46.0	189	294	40	70	
HP-4D470-S40-S14	47.0	193	298	40	70	
HP-4D480-S40-S14	48.0	197	302	40	70	
HP-4D490-S40-S14	49.0	201	306	40	70	
HP-4D500-S40-S14	50.0	205	310	40	70	

Drilling holders



Dimensions (mm)	Spare parts	
Holder diameter	Screw	Wrench
		
28-33	AST35084-60H	AWF-T15
34-41	AST410-60H	AWF-T15
42-50	AST5126-60	AWF-T20

DG Series Drilling holder

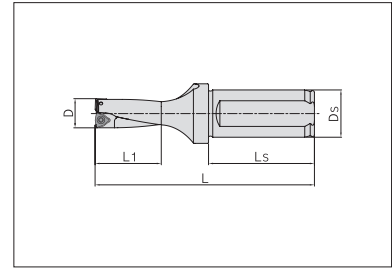
Length-diameter ratio: 2D

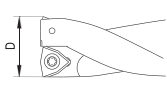

Product code	Dimension(mm)					Inserts
	D	L ₁	L	D _s	L _s	
HP-2D160-S25-W03	16.0	35	116	25	56	WCMT 030204E-DG
HP-2D165-S25-W03	16.5	36	117	25	56	
HP-2D170-S25-W03	17.0	37	118	25	56	
HP-2D175-S25-W03	17.5	38	119	25	56	
HP-2D180-S25-W03	18.0	39	120	25	56	
HP-2D185-S25-W03	18.5	40	121	25	56	
HP-2D190-S25-W03	19.0	41	122	25	56	
HP-2D195-S25-W03	19.5	42	123	25	56	
HP-2D200-S25-W03	20.0	43	124	25	56	
HP-2D205-S25-W04	20.5	44	125	25	56	WCMT 040204E-DG
HP-2D210-S25-W04	21.0	45	126	25	56	
HP-2D215-S25-W04	21.5	46	127	25	56	
HP-2D220-S25-W04	22.0	47	128	25	56	
HP-2D225-S25-W04	22.5	48	129	25	56	
HP-2D230-S25-W04	23.0	49	130	25	56	
HP-2D235-S25-W04	23.5	50	131	25	56	
HP-2D240-S25-W04	24.0	51	132	25	56	
HP-2D245-S25-W04	24.5	52	133	25	56	
HP-2D250-S25-W04	25.0	53	134	25	56	WCMT 050308E-DG
HP-2D255-S32-W05	25.5	54	144	32	60	
HP-2D260-S32-W05	26.0	55	145	32	60	
HP-2D265-S32-W05	26.5	56	146	32	60	
HP-2D270-S32-W05	27.0	57	147	32	60	
HP-2D275-S32-W05	27.5	58	148	32	60	
HP-2D280-S32-W05	28.0	59	149	32	60	
HP-2D285-S32-W05	28.5	60	150	32	60	
HP-2D290-S32-W05	29.0	61	151	32	60	
HP-2D295-S32-W05	29.5	62	152	32	60	
HP-2D300-S32-W05	30.0	63	153	32	60	

Dimensions (mm)	Spare parts	
Holder diameter	Screw	Wrench
		
16-20	AST22045-55	AWF-T06
20.5-25	AST25055-50	AWF-T08
25.5-30	AST307-55	AWF-T08



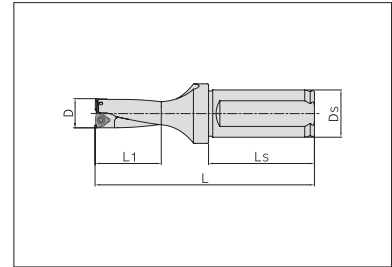

DG Series Drilling holder

Length-diameter ratio: 2D

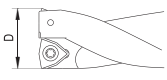

Product code	Dimension(mm)					Inserts
	D	L ₁	L	D _s	L _s	
HP-2D310-S32-W06	31.0	65	155	32	60	WCMT 06T308E-DG
HP-2D320-S32-W06	32.0	67	157	32	60	
HP-2D330-S32-W06	33.0	69	159	32	60	
HP-2D340-S32-W06	34.0	71	161	32	60	
HP-2D350-S32-W06	35.0	73	163	32	60	
HP-2D360-S32-W06	36.0	75	165	32	60	
HP-2D370-S32-W06	37.0	77	167	32	60	
HP-2D380-S32-W06	38.0	79	169	32	60	
HP-2D390-S32-W06	39.0	81	171	32	60	
HP-2D400-S32-W06	40.0	83	173	32	60	
HP-2D410-S32-W06	41.0	85	175	32	60	
HP-2D420-S40-W08	42.0	87	192	40	70	WCMT 080408E-DG
HP-2D430-S40-W08	43.0	89	194	40	70	
HP-2D440-S40-W08	44.0	91	196	40	70	
HP-2D450-S40-W08	45.0	93	198	40	70	
HP-2D460-S40-W08	46.0	95	200	40	70	
HP-2D470-S40-W08	47.0	97	202	40	70	
HP-2D480-S40-W08	48.0	99	204	40	70	
HP-2D490-S40-W08	49.0	101	206	40	70	
HP-2D500-S40-W08	50.0	103	208	40	70	
HP-2D510-S40-W08	51.0	105	210	40	70	
HP-2D520-S40-W08	52.0	107	212	40	70	
HP-2D530-S40-W08	53.0	109	214	40	70	
HP-2D540-S40-W08	54.0	111	216	40	70	
HP-2D550-S40-W08	55.0	113	218	40	70	
HP-2D560-S40-W08	56.0	115	220	40	70	
HP-2D570-S40-W08	57.0	117	222	40	70	
HP-2D580-S40-W08	58.0	119	224	40	70	

Drilling holders

Dimensions (mm)	Spare parts	
Holder diameter	Screw	Wrench
		
31-41	AST3509-55	AWF-T15
42-58	AST411-60W-M	AWF-T15

DG Series Drilling holder

Length-diameter ratio: 3D

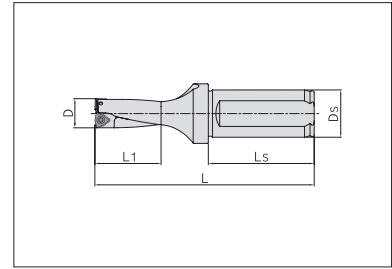
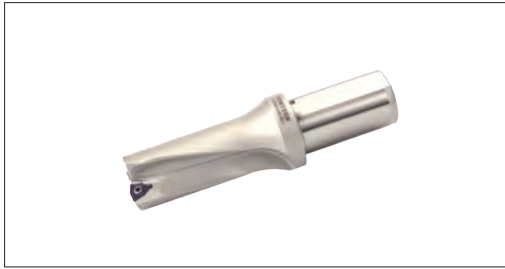

Product code	Dimension(mm)					Inserts
	D	L ₁	L	D _s	L _s	
HP-3D160-S25-W03	16.0	51	132	25	56	WCMT 030204E-DG
HP-3D165-S25-W03	16.5	53	134	25	56	
HP-3D170-S25-W03	17.0	54	135	25	56	
HP-3D175-S25-W03	17.5	56	137	25	56	
HP-3D180-S25-W03	18.0	57	138	25	56	
HP-3D185-S25-W03	18.5	59	140	25	56	
HP-3D190-S25-W03	19.0	60	141	25	56	
HP-3D195-S25-W03	19.5	62	143	25	56	
HP-3D200-S25-W03	20.0	63	144	25	56	
HP-3D205-S25-W04	20.5	65	146	25	56	WCMT 040204E-DG
HP-3D210-S25-W04	21.0	66	147	25	56	
HP-3D215-S25-W04	21.5	68	149	25	56	
HP-3D220-S25-W04	22.0	69	150	25	56	
HP-3D225-S25-W04	22.5	71	152	25	56	
HP-3D230-S25-W04	23.0	72	153	25	56	
HP-3D235-S25-W04	23.5	74	155	25	56	
HP-3D240-S25-W04	24.0	75	156	25	56	
HP-3D245-S25-W04	24.5	77	158	25	56	
HP-3D250-S25-W04	25.0	78	159	25	56	
HP-3D255-S32-W05	25.5	80	170	32	60	WCMT 050308E-DG
HP-3D260-S32-W05	26.0	81	171	32	60	
HP-3D265-S32-W05	26.5	83	173	32	60	
HP-3D270-S32-W05	27.0	84	174	32	60	
HP-3D275-S32-W05	27.5	86	176	32	60	
HP-3D280-S32-W05	28.0	87	177	32	60	
HP-3D285-S32-W05	28.5	89	179	32	60	
HP-3D290-S32-W05	29.0	90	180	32	60	
HP-3D295-S32-W05	29.5	92	182	32	60	
HP-3D300-S32-W05	30.0	93	183	32	60	

Dimensions (mm)	Spare parts	
	Screw	Wrench
Holder diameter		
16-20	AST22045-55	AWF-T06
20.5-25	AST25055-50	AWF-T08
25.5-30	AST307-55	AWF-T08



DG Series Drilling holder

Length-diameter ratio: 3D

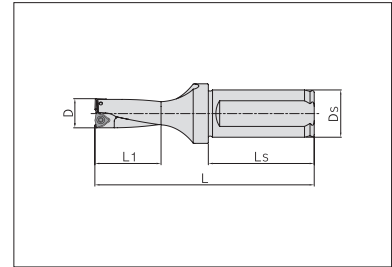

Product code	Dimension(mm)					Inserts
	D	L ₁	L	D _s	L _s	
HP-3D310-S32-W06	31.0	96	186	32	60	WCMT 06T308E-DG
HP-3D320-S32-W06	32.0	99	189	32	60	
HP-3D330-S32-W06	33.0	102	192	32	60	
HP-3D340-S32-W06	34.0	105	195	32	60	
HP-3D350-S32-W06	35.0	108	198	32	60	
HP-3D360-S32-W06	36.0	111	201	32	60	
HP-3D370-S32-W06	37.0	114	204	32	60	
HP-3D380-S32-W06	38.0	117	207	32	60	
HP-3D390-S32-W06	39.0	120	210	32	60	
HP-3D400-S32-W06	40.0	123	213	32	60	
HP-3D410-S32-W06	41.0	126	216	32	60	
HP-3D420-S40-W08	42.0	129	234	40	70	WCMT 080408E-DG
HP-3D430-S40-W08	43.0	132	237	40	70	
HP-3D440-S40-W08	44.0	135	240	40	70	
HP-3D450-S40-W08	45.0	138	243	40	70	
HP-3D460-S40-W08	46.0	141	246	40	70	
HP-3D470-S40-W08	47.0	144	249	40	70	
HP-3D480-S40-W08	48.0	147	252	40	70	
HP-3D490-S40-W08	49.0	150	255	40	70	
HP-3D500-S40-W08	50.0	153	258	40	70	
HP-3D510-S40-W08	51.0	156	261	40	70	
HP-3D520-S40-W08	52.0	159	264	40	70	
HP-3D530-S40-W08	53.0	162	267	40	70	
HP-3D540-S40-W08	54.0	165	270	40	70	
HP-3D550-S40-W08	55.0	168	273	40	70	
HP-3D560-S40-W08	56.0	171	276	40	70	
HP-3D570-S40-W08	57.0	174	279	40	70	
HP-3D580-S40-W08	58.0	177	282	40	70	

Drilling holders

Dimensions (mm)	Spare parts	
Holder diameter	Screw	Wrench
31-41	AST3509-55	AWF-T15
42-58	AST411-60W-M	AWF-T15

DG Series Drilling holder

Length-diameter ratio: 4D

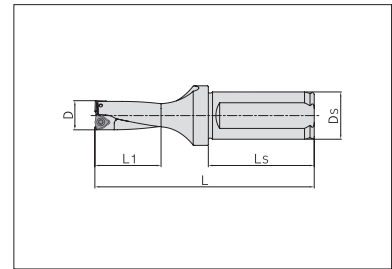

Product code	Dimension(mm)					Inserts
	D	L ₁	L	D _s	L _s	
HP-4D160-S25-W03	16.0	67	148	25	56	WCMT 030204E-DG
HP-4D165-S25-W03	16.5	69	150	25	56	
HP-4D170-S25-W03	17.0	71	152	25	56	
HP-4D175-S25-W03	17.5	73	154	25	56	
HP-4D180-S25-W03	18.0	75	156	25	56	
HP-4D185-S25-W03	18.5	77	158	25	56	
HP-4D190-S25-W03	19.0	79	160	25	56	
HP-4D195-S25-W03	19.5	81	162	25	56	
HP-4D200-S25-W03	20.0	83	164	25	56	
HP-4D205-S25-W04	20.5	85	166	25	56	WCMT 040204E-DG
HP-4D210-S25-W04	21.0	87	168	25	56	
HP-4D215-S25-W04	21.5	89	170	25	56	
HP-4D220-S25-W04	22.0	91	172	25	56	
HP-4D225-S25-W04	22.5	93	174	25	56	
HP-4D230-S25-W04	23.0	95	176	25	56	
HP-4D235-S25-W04	23.5	97	178	25	56	
HP-4D240-S25-W04	24.0	99	180	25	56	
HP-4D245-S25-W04	24.5	101	182	25	56	
HP-4D250-S25-W04	25.0	103	184	25	56	
HP-4D255-S32-W05	25.5	105	195	32	60	WCMT 050308E-DG
HP-4D260-S32-W05	26.0	107	197	32	60	
HP-4D265-S32-W05	26.5	109	199	32	60	
HP-4D270-S32-W05	27.0	111	201	32	60	
HP-4D275-S32-W05	27.5	113	203	32	60	
HP-4D280-S32-W05	28.0	115	205	32	60	
HP-4D285-S32-W05	28.5	117	207	32	60	
HP-4D290-S32-W05	29.0	119	209	32	60	
HP-4D295-S32-W05	29.5	121	211	32	60	
HP-4D300-S32-W05	30.0	123	213	32	60	

Dimensions (mm)	Spare parts	
Holder diameter	Screw	Wrench
16-20	AST22045-55	AWF-T06
20.5-25	AST25055-50	AWF-T08
25.5-30	AST307-55	AWF-T08



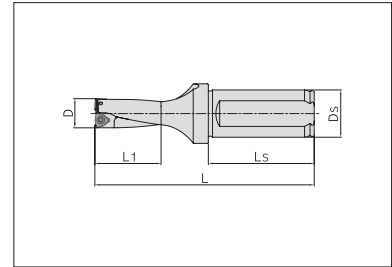

DG Series Drilling holder

Length-diameter ratio: 4D

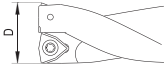

Product code	Dimension(mm)					Inserts
	D	L ₁	L	D _s	L _s	
HP-4D310-S32-W06	31.0	127	217	32	60	WCMT 06T308E-DG
HP-4D320-S32-W06	32.0	131	221	32	60	
HP-4D330-S32-W06	33.0	135	225	32	60	
HP-4D340-S32-W06	34.0	139	229	32	60	
HP-4D350-S32-W06	35.0	143	233	32	60	
HP-4D360-S32-W06	36.0	147	237	32	60	
HP-4D370-S32-W06	37.0	151	241	32	60	
HP-4D380-S32-W06	38.0	155	245	32	60	
HP-4D390-S32-W06	39.0	159	249	32	60	
HP-4D400-S32-W06	40.0	163	253	32	60	
HP-4D410-S32-W06	41.0	167	257	32	60	
HP-4D420-S40-W08	42.0	171	276	40	70	WCMT 080408E-DG
HP-4D430-S40-W08	43.0	175	280	40	70	
HP-4D440-S40-W08	44.0	179	284	40	70	
HP-4D450-S40-W08	45.0	183	288	40	70	
HP-4D460-S40-W08	46.0	187	292	40	70	
HP-4D470-S40-W08	47.0	191	296	40	70	
HP-4D480-S40-W08	48.0	195	300	40	70	
HP-4D490-S40-W08	49.0	199	304	40	70	
HP-4D500-S40-W08	50.0	203	308	40	70	
HP-4D510-S40-W08	51.0	207	312	40	70	
HP-4D520-S40-W08	52.0	211	316	40	70	
HP-4D530-S40-W08	53.0	215	320	40	70	
HP-4D540-S40-W08	54.0	219	324	40	70	
HP-4D550-S40-W08	55.0	223	328	40	70	
HP-4D560-S40-W08	56.0	227	332	40	70	
HP-4D570-S40-W08	57.0	231	336	40	70	
HP-4D580-S40-W08	58.0	235	340	40	70	

Drilling holders

Dimensions (mm)	Spare parts	
Holder diameter	Screw	Wrench
		
31-41	AST3509-55	AWF-T15
42-58	AST411-60W-M	AWF-T15

Drilling Insert Denomination System

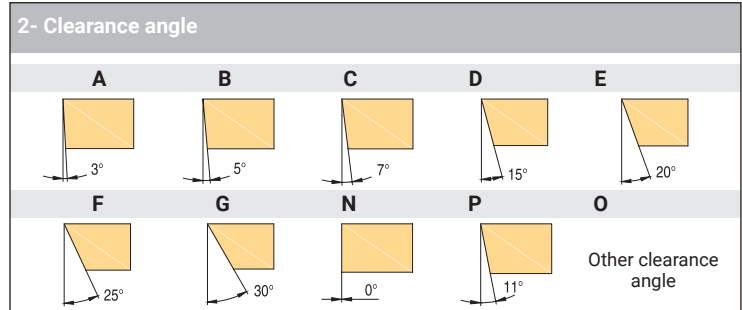
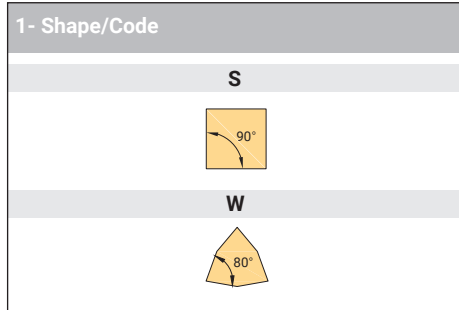

3- Tolerance

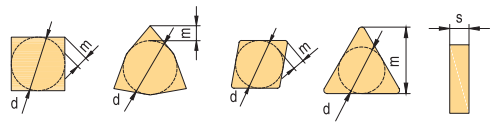

Class	Unit	In. Circle dimension d	Nose height m	Thickness
A	mm	± 0,025	± 0,005	± 0,025
C	mm	± 0,025	± 0,013	± 0,025
E	mm	± 0,025	± 0,025	± 0,025
F	mm	± 0,013	± 0,005	± 0,025
G	mm	± 0,025	± 0,025	± 0,13
H	mm	± 0,013	± 0,013	± 0,025
J	mm	*	± 0,005	± 0,025
K	mm	*	± 0,013	± 0,025
L	mm	*	± 0,025	± 0,025
M	mm	*	*	± 0,127
U	mm	*	*	± 0,127
N	mm	*	*	± 0,025

* For details refer to right and below tables

Shape: C, E, H, M, O, P, S, T, R, W

IC	d		m	
	J,K,L,M,N	U	M, N	U
4.76	± 0,05	± 0,08	± 0,08	± 0,13
5.56	± 0,05	± 0,08	± 0,08	± 0,13
6	± 0,05	± 0,08	± 0,08	± 0,13
6.35	± 0,05	± 0,08	± 0,08	± 0,13
7.94	± 0,05	± 0,08	± 0,08	± 0,13
8	± 0,05	± 0,08	± 0,08	± 0,13
9.525	± 0,05	± 0,08	± 0,08	± 0,13
10	± 0,05	± 0,08	± 0,08	± 0,13
12	± 0,08	± 0,13	± 0,13	± 0,2
12.7	± 0,08	± 0,13	± 0,13	± 0,2
15.875	± 0,1	± 0,18	± 0,15	± 0,27
16	± 0,1	± 0,18	± 0,15	± 0,27
19.05	± 0,1	± 0,18	± 0,15	± 0,27
20	± 0,1	± 0,18	± 0,15	± 0,27
25	± 0,13	± 0,25	± 0,18	± 0,38
25.4	± 0,13	± 0,25	± 0,18	± 0,38
31.75	± 0,15	± 0,25	± 0,2	± 0,38
32	± 0,15	± 0,25	± 0,2	± 0,38

M&N shape	D shape		V shape	
	d	m	d	m
5.56	± 0,05	± 0,11		
6.35	± 0,05	± 0,11	± 0,05	± 0,16
7.94	± 0,05	± 0,11	± 0,05	± 0,16
9.525	± 0,05	± 0,11	± 0,05	± 0,16
12.7	± 0,08	± 0,15	± 0,08	± 0,2
15.875	± 0,10	± 0,18	± 0,10	± 0,27
19.05	± 0,10	± 0,18	± 0,10	± 0,27

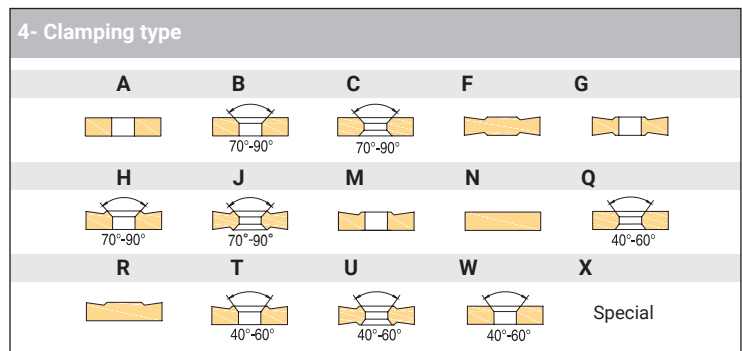

06
5



02
6

04
7

E
8

-
-

DP
9

5- Cutting edge length				
In.Circle Dimension (mm)	S Code	 Length	W Code	 Length
5.56			03	3.8
6.35	06	6.35	04	4.3
7.94			05	5.4
8.0	08	8.0		
9.525	09	9.525	06	6.5
12.7	12	12.7	08	8.7

7- Corner radius		
Example		
04	=	0.4
08	=	0.8
12	=	1.2

8- Cutting edge shape	
Example	Illustration
E	Honed cutting edge
F	Sharp cutting edge
T	Negative land

6- Insert thickness		
Thickness illustration	Thickness mark	Example
		00 = 0.79
		T0 = 0.99
		01 = 1.59
		T1 = 1.98
		02 = 2.38
		T2 = 2.58
		03 = 3.18
		T3 = 3.97
		04 = 4.76
		T4 = 4.96
		05 = 5.56
		T5 = 5.95
		06 = 6.35
		07 = 7.94
		09 = 9.53
		11 = 11.11
		12 = 12.70
		14 = 14.29
		15 = 15.88

Insert thickness "S" refers to the distance between cutting edge nose and bottom

9- Chip breaker code	
DP	DU/DG
	

10. Chip breakers' information refer to page 298

Drilling inserts

Geometry Application Guide

DP

1. DP geometry has high efficiency. Suitable for short hole high speed drilling.
2. Strong square insert with reinforced geometry offers excellent hole straightness.
3. Drilling holder with helical flute provides excellent chip evacuation and high hole precision.

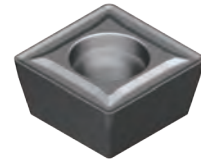

DU/DG

1. Suitable cutting angle makes perfect balance for the cutting force.
2. General purpose geometry combined with two grades are suitable for PM,K,S materials, especially good for the chip control in soft materials.
3. Obtains good surface finish.
4. Good versatility. It's suitable for rotating and non-rotating machining.



Grade Application Guide

Drilling insert grade ISO group								
Material Group	Materials	ISO	AP301U	AP351U	AP351M	AC301P	ISO	
P	Unalloy steels / Alloyed steels	P01					P01	
		P05					P05	
		P10					P10	
		P15	AP301U					P15
		P20					P20	
		P25				AP351M	AC301P	P25
		P30						P30
		P35		AP351U				P35
		P40						P40
		P45						P45
		P50						P50
M	Stainless steels	M01					M01	
		M05					M05	
		M10					M10	
		M15	AP301U					M15
		M20					M20	
		M25			AP351M			M25
		M30		AP351U				M30
		M35						M35
		M40					M40	
M45					M45			
K	Cast iron	K01					K01	
		K05					K05	
		K10					K10	
		K15					K15	
		K20					K20	
		K25					K25	
		K30					K30	
		K35					K35	
		K40					K40	
		K45					K45	
S	Heat resistant alloys	S01					S01	
		S05					S05	
		S10					S10	
		S15					S15	
		S20					S20	
		S25			AP351M			S25
		S30		AP351U				S30
		S35						S35
		S40					S40	
		S45					S45	
N	Aluminum/ Aluminum alloys	N01					N01	
		N05					N05	
		N10					N10	
		N15					N15	
		N20					N20	
		N25					N25	
		N30					N30	
H	Hardened steels/ Chilled cast iron	H01					H01	
		H05					H05	
		H10					H10	
		H15					H15	
		H20					H20	
		H25					H25	
H30					H30			

Drilling inserts

Grade Application Guide

Materials				PVD coated			CVD coated
				AP301U	AP351U	AP351M	AC301P
ISO	Material classification	Tensile strength (N/mm ²)	Hardness (HB)	Priority			
P	Unalloyed steel	<600	<180	●	●	●	●
		<950	<280	●	●	●	●
	Alloyed steel	700-950	200-280	●	●	●	●
		950-1200	280-355	●	●	●	●
		1200-1400	355-415	●	●	●	●
M	Duplex stainless steel	778	230	◐	●	●	-
	Austenitic stainless steel	675	200	◐	●	●	-
	Precipitation-hardening stainless steel	1013	300	◐	●	●	-
K	Grey cast iron	700	220	-	-	-	-
	Nodular cast iron	880	260	-	-	-	-
	Malleable cast iron	800	250	-	-	-	-
S	Fe-based alloy	943	280	-	◐	●	-
	Co-based alloy	1076	320	-	◐	●	-
	Ni-based alloy	1177	350	-	◐	●	-
	Ti-alloy	1262	370	-	◐	●	-
N	Aluminum	260	75	-	-	-	-
	Aluminum alloy	447	130	-	-	-	-
H	Hardened steel	-	50-60HRC	-	-	-	-
	Chilled cast iron	-	55HRC	-	-	-	-

- Best choice
- ◐ 2nd choice
- Inapplicable

Drilling Grade Description

AP301U

Coating: PVD coating

Suitable for steel, stainless steel drilling. High strength and wear resistance ultra fine carbide substrate with nanostructured PVD coating in controllable layer, high coating adhesion, wear-resistance and strength.

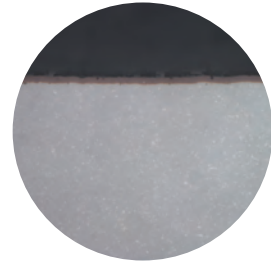

Application range												
ISO Classification	01	05	10	15	20	25	30	35	40	45	50	
P				AP301U								
M				AP301U								
K												
S												
N												
H												

Remark: Best choice
 2nd choice

AP351U

Coating: PVD coating

Suitable for steel, stainless steel and heat resistant alloy drilling. High strength carbide substrate with nanostructured PVD coating in controllable layer, high coating adhesion, wear-resistance and strength.

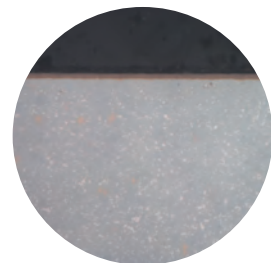

Application range												
ISO Classification	01	05	10	15	20	25	30	35	40	45	50	
P							AP351U					
M							AP351U					
K												
S							AP351U					
N												
H												

Remark: Best choice
 2nd choice

Drilling inserts

AC301P

Coating: CVD coating

For steel and cast iron drilling. High strength substrate combined with multi-layer CVD, good coating adhesion and strength.

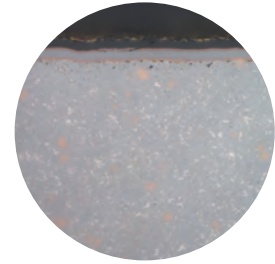

Application range											
ISO Classification	01	05	10	15	20	25	30	35	40	45	50
P						AC301P					
M											
K											
S											
N											
H											

Remark: Best choice
 2nd choice

AP351M

Coating: PVD coating

Suitable for steel, stainless steel and heat resistant alloy drilling. Good stability and wear resistance. Good thermal crack resistance and high coating adhesion and strength.

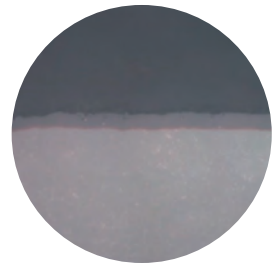

Application range											
ISO Classification	01	05	10	15	20	25	30	35	40	45	50
P						AP351M					
M						AP351M					
K											
S						AP351M					
N											
H											

Remark: Best choice
 2nd choice

SPMT-DP Drilling Insert

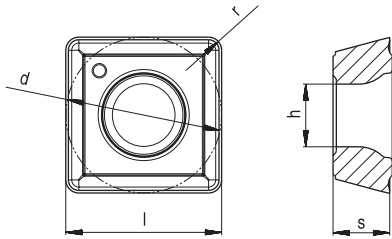

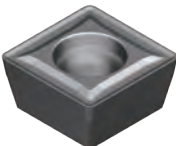

Inserts	Product code	Dimension(mm)					Grades								
		l	d	s	r	h	AP301U	AP351U	AC301P	AP351M	AP401U	AP351K	AC301K	AW100K	AP403S
	SPMT 050204E-DP	5	5	2.38	0.4	2.25	●	●	●	●					
	SPMT 060204E-DP	6	6	2.38	0.4	2.61	●	●	●	●					
	SPMT 07T308E-DP	7.94	7.94	3.97	0.8	2.85	●	●	●	●					
	SPMT 090408E-DP	9.8	9.8	4.3	0.8	4.05	●	●	●	●					
	SPMT 110408E-DP	11.5	11.5	4.8	0.8	4.45	●	●	●	●					
	SPMT 140512E-DP	14.3	14.3	5.2	1.2	5.75	●	●	●	●					

Marked : ● Stock available

Drilling inserts

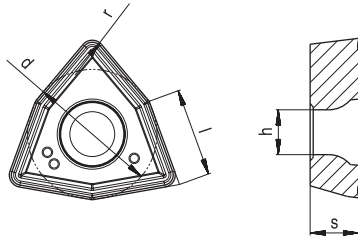
WCMT-DU Drilling Insert





Inserts	Product code	Dimension(mm)					Grades									
		l	d	s	r	h	AP301U	AP351U	AC301P	AP351M	AP401U	AP351K	AC301K	AW100K	AP403S	
	WCMT 030208E-DU	3.8	5.56	2.38	0.8	2.8	●	●								
	WCMT 040208E-DU	4.3	6.35	2.38	0.8	3.0	●	●								
	WCMT 050308E-DU	5.4	7.94	3.18	0.8	3.4	●	●								
	WCMT 06T308E-DU	6.5	9.525	3.97	0.8	3.9	●	●								
	WCMT 080412E-DU	8.7	12.7	4.76	1.2	4.4	●	●								

Note: The DU insert is a universal insert and Achteck does not provide a tool holder.

Marked : ● Stock available

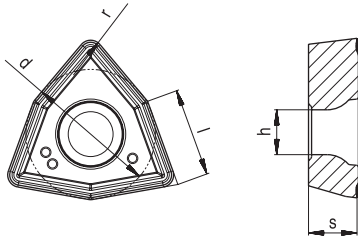
WCMT-DG Drilling Insert



Inserts	Product code	Dimension(mm)					Grades									
		l	d	s	r	h	AP301U	AP351U	AC301P	AP351M	AP401U	AP351K	AC301K	AW100K	AP403S	
	WCMT 030204E-DG	3.8	5.56	2.38	0.4	2.5	●	●								
	WCMT 040204E-DG	4.3	6.35	2.38	0.4	2.8	●	●								
	WCMT 050308E-DG	5.4	7.94	3.18	0.8	3.4	●	●								
	WCMT 06T308E-DG	6.5	9.525	3.97	0.8	4.45	●	●								
	WCMT 080408E-DG	8.7	12.7	4.76	0.8	5.5	●	●								

Marked : ● Stock available

Drilling inserts



Cutting Parameter Recommendation

Materials		SP drilling insert series grade application range & cutting parameter recommendation																				
		Grade					Feed (mm/rev)					Feed (mm/rev)										
ISO	Material classification	Tensile strength (N/mm ²)	Hardness (HB)	Cutting speed (m/min)					Feed (mm/rev)					Feed (mm/rev)								
				Min	Med	Max	Min	Med	Max	Min	Med	Max	Min	Med	Max	Min	Med	Max				
P	Unalloyed steel	<600	<180	260	240	224	220	185	150	240	220	200	200	175	150	0.05-0.08	0.06-0.10	0.06-0.12	0.07-0.13	0.08-0.15	0.08-0.16	
		<950	<280	250	210	170	200	170	140	230	190	160	190	162.5	135	0.06-0.12	0.08-0.15	0.10-0.18	0.12-0.22	0.12-0.24	0.13-0.25	
		700-950	200-280	240	200	160	190	160	130	220	180	150	180	150	120	0.06-0.10	0.08-0.14	0.10-0.18	0.12-0.22	0.12-0.23	0.13-0.24	
		950-1200	280-355	210	170	130	170	130	90	190	150	110	160	130	100	0.06-0.12	0.08-0.15	0.10-0.18	0.12-0.22	0.12-0.24	0.13-0.25	
M	Duplex stainless steel	1200-1400	355-415	170	140	110	160	120	80	150	120	90	140	110	80	0.06-0.10	0.08-0.14	0.10-0.18	0.12-0.22	0.12-0.23	0.13-0.24	
		778	230	260	200	140	180	135	90	240	180	120	-	-	-	0.05-0.10	0.06-0.12	0.08-0.15	0.09-0.16	0.10-0.17	0.11-0.18	
K	Austenitic stainless steel	675	200	220	170	120	120	65	60	200	150	100	-	-	-	0.05-0.10	0.06-0.12	0.08-0.15	0.09-0.16	0.10-0.17	0.11-0.18	
		1013	300	180	140	100	90	65	40	160	120	80	-	-	-	-	-	-	-	-	-	
		700	220	-	-	-	-	-	-	-	-	-	-	-	-	-	-	-	-	-	-	-
S	Grey cast iron	880	260	-	-	-	-	-	-	-	-	-	-	-	-	-	-	-	-	-	-	-
		800	250	-	-	-	-	-	-	-	-	-	-	-	-	-	-	-	-	-	-	-
		943	280	-	-	40	30	20	45	35	25	-	-	-	-	-	-	-	-	-	-	-
		1076	320	-	-	35	25	15	40	30	20	-	-	-	-	-	-	-	-	-	-	-
N	Co-based alloy	1177	350	-	-	35	25	15	40	30	20	-	-	-	-	-	-	-	-	-	-	
		1262	370	-	-	40	30	20	45	35	25	-	-	-	-	0.05-0.10	0.06-0.14	0.08-0.18	0.10-0.22	0.14-0.23	0.15-0.24	
H	Aluminum alloy	260	75	-	-	-	-	-	-	-	-	-	-	-	-	-	-	-	-	-	-	
		447	130	-	-	-	-	-	-	-	-	-	-	-	-	-	-	-	-	-	-	
H	Hardened steel	50-60HRC	-	-	-	-	-	-	-	-	-	-	-	-	-	-	-	-	-	-	-	
		55HRC	-	-	-	-	-	-	-	-	-	-	-	-	-	-	-	-	-	-	-	

*The recommended cutting conditions always refer to general conditions. These cutting conditions should be adjusted according to the practical machine rigidity, tools, workpiece clamping and coolants.

Cutting Parameter Recommendation

Materials		WC drilling insert series grade application range & cutting parameter recommendation																		
		AP301U	AP351U	AC301P	Feed (mm/rev)								φ 41mm~φ 58 mm							
ISO	Material classification	Tensile strength (N/mm ²)	Hardness (HB)	Cutting speed (m/min)			Feed (mm/rev)													
				Min	Med	Max	Min	Med	Max	Min	Med	Max	Min	Med	Max					
P	Unalloyed steel	<600	<180	260	240	224	220	185	150	150	200	175	150	0.04-0.065	0.07-0.09	0.07-0.10	0.08-0.11	0.08-0.11	0.09-0.13	
		<950	<280	250	210	170	200	170	140	140	190	162.5	135	0.05-0.07	0.09-0.09	0.07-0.10	0.08-0.11	0.08-0.11	0.09-0.13	
		700-950	200-280	240	200	160	190	160	130	180	150	120	120	0.05-0.09	0.065-0.14	0.08-0.16	0.10-0.18	0.10-0.20	0.10-0.20	
		950-1200	280-355	210	170	130	170	130	90	160	130	100	100	0.04-0.07	0.065-0.11	0.07-0.14	0.09-0.15	0.10-0.18	0.10-0.18	
M	Duplex stainless steel	1200-1400	355-415	170	140	110	160	120	80	80	140	110	80	0.04-0.065	0.05-0.9	0.07-0.10	0.08-0.12	0.08-0.12	0.09-0.13	
		778	230	260	200	140	180	135	90	-	-	-	-	0.04-0.07	0.065-0.11	0.08-0.14	0.08-0.11	0.09-0.13		
		675	200	220	170	120	120	65	60	-	-	-	-	0.04-0.065	0.065-0.10	0.08-0.12	0.08-0.10	0.08-0.11		
		1013	300	180	140	100	90	65	40	-	-	-	-	-	-	-	-	-	-	
K	Grey cast iron	700	220	-	-	-	-	-	-	-	-	-	-	-	-	-	-	-	-	-
		880	260	-	-	-	-	-	-	-	-	-	-	-	-	-	-	-	-	-
		800	250	-	-	-	-	-	-	-	-	-	-	-	-	-	-	-	-	-
		943	280	-	-	-	40	30	20	-	-	-	-	-	-	-	-	-	-	-
S	Co-based alloy	1076	320	-	-	-	35	25	15	-	-	-	-	-	-	-	-	-	-	-
		1177	350	-	-	-	35	25	15	-	-	-	-	-	-	-	-	-	-	-
		1262	370	-	-	-	40	30	20	-	-	-	-	0.05-0.10	0.06-0.11	0.07-0.12	0.08-0.13	0.08-0.13	0.08-0.14	
		260	75	-	-	-	-	-	-	-	-	-	-	-	-	-	-	-	-	-
N	Aluminum alloy	447	130	-	-	-	-	-	-	-	-	-	-	-	-	-	-	-	-	-
		-	50-60HRC	-	-	-	-	-	-	-	-	-	-	-	-	-	-	-	-	-
H	Chilled cast iron	-	55HRC	-	-	-	-	-	-	-	-	-	-	-	-	-	-	-	-	-
		-	-	-	-	-	-	-	-	-	-	-	-	-	-	-	-	-	-	-

*The recommended cutting conditions always refer to general conditions. These cutting conditions should be adjusted according to the practical machine rigidity, tools, workpiece clamping and coolants.



Deep-hole Drilling Product Introduction

Achteck has launched general-purpose deep-hole drilling inserts, which offer high productivity for many industries: energy, engineering machinery, injection molding, aircraft, shipbuilding, military, etc. It can achieve good hole straightness in deep hole drilling and good surface finish. Existing geometries and grades cover steel, stainless steel and heat resistant alloy drilling.

Product application and features

- The inserts can be mounted on the deep-hole drilling head.
- AP301U(N) is the first choice for drilling steel and stainless steel
- All geometries offer good chip-breaking result
- Increased efficiency due to high feed rate
- Reduces the cost per hole

Grade and Application

Grade	Coating	Workpiece material					
		P	M	K	S	N	H
AP301U(M)	PVD	●	●		○		



● Marked: 1st Choice ● Marked: 2nd Choice ○ Marked: Supplementary application

ISO P : (P15-P35) General-purpose PVD coating with excellent wear-resistance and toughness.

ISO M :(M15-M35) General-purpose grade for ISO-M applications, PVD coating with excellent toughness and resistance to built-up edges.

ISO S :(S15-S35) PVD coating with excellent wear resistance and toughness, good resistance to built-up edges.

Geometry Types and Features

Geometry	Edge shape	Application
DH		<ul style="list-style-type: none"> • For general purpose. • Suitable for high cutting speed and feed. • Good chip control in most of materials.
DL		<ul style="list-style-type: none"> • Suitable for long chip materials (such as low carbon alloy steel and duplex stainless steel). • Obtain a reliable production process in drilling materials where chip jamming can be a problem.
LH		<ul style="list-style-type: none"> • With open geometry; • Suitable for high cutting speed and feed.

DH Geometry

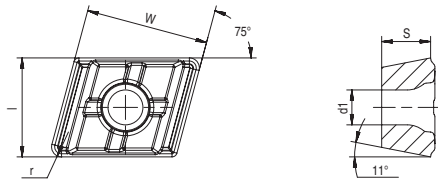

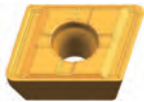
Center insert	Product code	l	w	s	r	d1	Competitor's description	Stock
	EPMT 050308C-DH AP301U(N)	5.56	8	3.18	0.8	2.5	800-050308M-C-G 1025	●
	EPMT 06T308C-DH AP301U(N)	6.35	9.87	3.97	0.8	2.8	800-06T308M-C-G 1025	●
	EPMT 08T308C-DH AP301U(N)	7.94	9.87	3.97	0.8	2.8	800-08T308M-C-G 1025	●
	EPMT 10T308C-DH AP301U(N)	9.53	9.87	3.97	0.8	2.8	800-10T308M-C-G 1025	●
	EPMT 12T308C-DH AP301U(N)	12.7	9.87	3.97	0.8	2.8	800-12T308M-C-G 1025	●

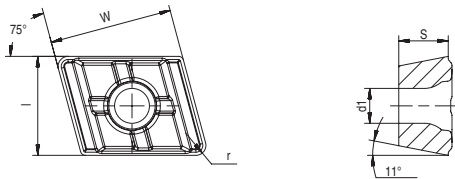

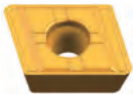
Intermediate insert	Product code	l	w	s	r	d1	Competitor's description	Stock
	EPMT 050308I-DH AP301U(N)	5.56	8	3.18	0.8	2.5	800-050308M-I-G 1025	●
	EPMT 06T308I-DH AP301U(N)	6.35	9.87	3.97	0.8	2.8	800-06T308M-I-G 1025	●
	EPMT 08T308I-DH AP301U(N)	7.94	9.87	3.97	0.8	2.8	800-08T308M-I-G 1025	●
	EPMT 12T308I-DH AP301U(N)	12.7	9.87	3.97	0.8	2.8	800-12T308M-I-G 1025	●

Marked : ● Stock available

Drilling inserts

DH Geometry

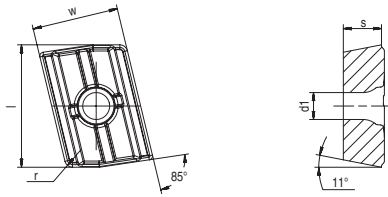

Periphery insert	Product code	l	w	s	r	d1	Competitor's description	Stock
	APHT 060308P-DH AP301U(N)	6.5	8	3.18	0.8	2.5	800-060308H-P-G 1025	●
	APHT 08T308P-DH AP301U(N)	8.5	9	3.97	0.8	2.8	800-08T308H-P-G 1025	●
	APHT 09T308P-DH AP301U(N)	9.66	9	3.97	0.8	2.8	800-09T308H-P-G 1025	●
	APHT 11T308P-DH AP301U(N)	12.75	9	3.97	0.8	2.8	800-11T308H-P-G 1025	●

DL Geometry

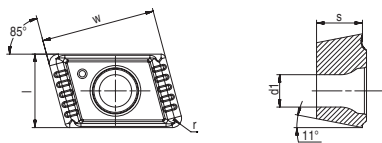

Intermediate insert	Product code	l	w	s	r	d1	Competitor's description	Stock
	EPMT 050308I-DL AP301U(N)	5.56	8	3.18	0.8	2.5	800-050308M-I-L 1025	●
	EPMT 06T308I-DL AP301U(N)	6.35	9.87	3.97	0.8	2.8	800-06T308M-I-L 1025	●
	EPMT 08T308I-DL AP301U(N)	7.94	9.87	3.97	0.8	2.8	800-08T308M-I-L 1025	●
	EPMT 12T308I-DL AP301U(N)	12.7	9.87	3.97	0.8	2.8	800-12T308M-I-L 1025	●

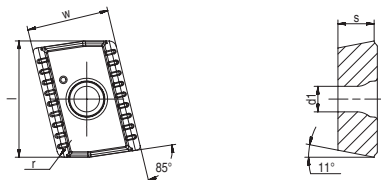

Periphery insert	Product code	l	w	s	r	d1	Competitor's description	Stock
	APHT 060308P-DL AP301U(N)	6.5	8	3.18	0.8	2.5	800-060308H-P-L 1025	●
	APHT 08T308P-DL AP301U(N)	8.5	9	3.97	0.8	2.8	800-08T308H-P-L 1025	●
	APHT 09T308P-DL AP301U(N)	9.66	9	3.97	0.8	2.8	800-09T308H-P-L 1025	●
	APHT 11T308P-DL AP301U(N)	12.75	9	3.97	0.8	2.8	800-11T308H-P-L 1025	●

Marked : ● Stock available

DH Geometry

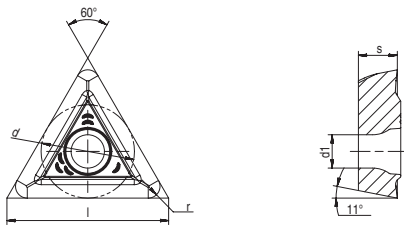

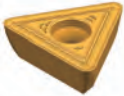
Center/Intermediate insert	Product code	l	d	s	r	d1	Competitor's description	Stock
	TPMT 16T312R-DH AP301U(N)	16.5	9.525	3.97	1.2	3.4	TPMT 16T308R-23 1025	●
	TPMT 220612R-DH AP301U(N)	22	12.7	6.35	1.2	4.4	TPMT 220612R-23 1025	●

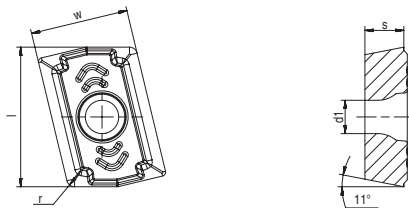

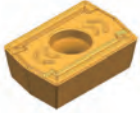
Periphery insert	Product code	l	d	s	r	d1	Competitor's description	Stock
	APMT 13T308-DH AP301U(N)	14.6	10	3.97	0.8	3.4	R424.9-13T308-23 1025	●
	APMT 180608-DH AP301U(N)	20.6	11.5	6.35	0.8	4.4	R424.9-180608-23 1025	●

Marked : ● Stock available

Drilling inserts

LH Geometry

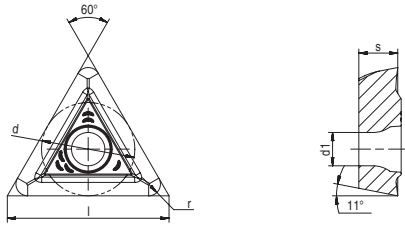

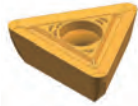
Center/Intermediate insert	Product code	l	d	s	r	d1	Competitor's description	Stock
	TPMT 16T312R-LH AP301U(N)	16.5	9.525	3.97	1.2	3.4	TPMT 16T308R-22 1025	●
	TPMT 220612R-LH AP301U(N)	22	12.7	6.35	1.2	4.4	TPMT 220612R-22 1025	●

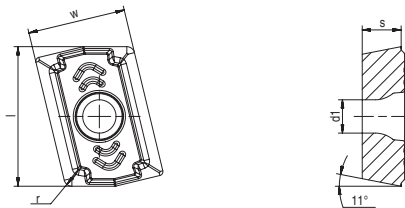

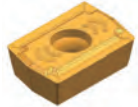
Periphery insert	Product code	l	d	s	r	d1	Competitor's description	Stock
	APMT 13T308-LH AP301U(N)	14.6	10	3.97	0.8	3.4	R424.9-13T308-22 1025	●
	APMT 180608-LH AP301U(N)	20.6	11.5	6.35	0.8	4.4	R424.9-180608-22 1025	●

Marked : ● Stock available

Guiding Pad

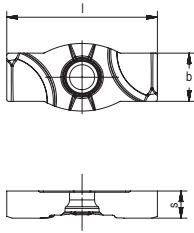

Guiding pad	Product code	b	l	s	Competitor's description	Stock
	GPAD-06A AC301K	6.00	18.00	3.00	800-06A PM1	●
	GPAD-07A AC301K	6.90	20.00	3.50	800-07A PM1	●
	GPAD-08A AC301K	8.00	25.00	4.50	800-08A PM1	●
	GPAD-10A AC301K	10.00	30.00	4.50	800-10A PM1	●
	GPAD-12A AC301K	12.00	35.00	5.50	800-12A PM1	●

TPMX Series

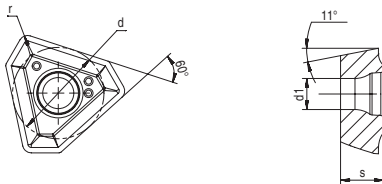

Sharp	Product code	s	d	r	d1	Competitor's description	Stock
	TPMX 1403R-DH AP301U(N)	3.50	8.45	0.80	2.87	TPMX 1403RG TT9030	●
	TPMX 1704R-DH AP301U(N)	4.00	10.30	0.80	3.90	TPMX 1704RG TT9030	●
	TPMX 2405R-DH AP301U(N)	5.50	14.20	1.20	4.40	TPMX 2405RG TT9030	●
	TPMX 2405L-DH AP301U(N)	5.50	14.20	1.20	4.40	TPMX 2405LG TT9030	●
	TPMX 2807R-DH AP301U(N)	7.50	17.00	1.60	5.50	TPMX 2807RG TT9030	●

Marked : ● Stock available

Drilling inserts

Recommended Cutting Speed for Materials(Dia 25.00-65.00mm)

	Workpiece material		Brinell hardness (HB)	Grade			Cutting speed Vc m/min	Feed fn mm/r	
				Insert				Drilling dia mm	
				P	I	C		25.00-43.00	43.01-65.00
P	Unalloyed steel	C=0.05-0.10%	125	AP301U(N)			70-130	0.11-0.41	0.14-0.45
		C=0.10-0.25%	125				70-130	0.11-0.41	0.14-0.45
		C=0.25-0.55%	150				70-130	0.11-0.41	0.14-0.45
		C=0.55-0.80%	170				70-130	0.11-0.41	0.14-0.45
	High carbon steel	Carbon tool steel	210	AP301U(N)			70-120	0.11-0.41	0.20-0.45
	Low-alloyed steel	Non-Hardened	180	AP301U(N)			55-110	0.11-0.41	0.20-0.45
		Tempered	275				70-120	0.11-0.41	0.20-0.45
		Tempered	350				70-120	0.11-0.41	0.20-0.45
	High-alloyed steel	Annealed	200	AP301U(N)			55-110	0.11-0.38	0.20-0.40
		Hardened tool steel	325				55-110	0.20-0.38	0.20-0.40
Cast steel	Non-alloyed steel	180	AP301U(N)			55-110	0.11-0.41	0.20-0.45	
	Low-alloy (alloy<5%)	200				55-110	0.11-0.41	0.20-0.45	
M	Stainless steel	Non-Hardened/Ferritic/martensitic	200	AP301U(N)			40-110	0.11-0.41	0.20-0.45
		Austenitic	200				40-110	0.11-0.41	0.20-0.45
		Austenitic, precipitation hardened (PH)	300				40-110	0.11-0.33	0.20-0.35
		Austenitic/ferritic, duplex	230				40-80	0.11-0.33	0.20-0.35
K	Malleable cast iron	Ferritic	200	AP301U(N)			80-120	0.11-0.38	0.24-0.41
		Pearlitic	260				80-120	0.11-0.38	0.24-0.41
	Grey cast iron	Low tensile strength	180	AP301U(N)			60-110	0.11-0.38	0.24-0.41
		High tensile strength	245				60-110	0.11-0.38	0.24-0.41
	Nodular cast iron	Ferritic	160	AP301U(N)			50-110	0.11-0.38	0.24-0.41
		Pearlitic	250				50-110	0.11-0.38	0.24-0.41
GGV (CGI)		230							
N	Wrought aluminium alloys	non-aging	30	AP301U(N)			65-150	0.09-0.33	0.20-0.33
		aged	100				65-150	0.09-0.33	0.20-0.33
	Cast aluminium alloys	≤ 12% Si, non-aging	75	AP301U(N)			65-150	0.09-0.33	0.20-0.33
		≤ 12% Si, aged	90				65-150	0.09-0.33	0.20-0.33
		> 12% Si, non-aging	130				65-150	0.09-0.33	0.20-0.33
	Magnesium alloy		70						
	Copper and copper alloys (bronze/brass)	Unalloyed, electrolytic copper	100	AP301U(N)			65-150	0.09-0.33	0.20-0.33
		Brass, bronze, red brass	90				65-150	0.09-0.33	0.20-0.33
Cu alloys, short-chip		110	65-150				0.09-0.33	0.20-0.33	
High tensile, Ampco alloy		300	65-150				0.09-0.33	0.20-0.33	
S	Heat-resistant alloys	Fe-based annealed	200	AP301U(N)			10-55	0.09-0.30	0.20-0.33
		Fe-based hardened	280				10-55	0.09-0.30	0.20-0.33
		Ni or Co-based annealed	250				10-55	0.09-0.30	0.20-0.33
		Ni or Co-based hardened	350				10-55	0.09-0.30	0.20-0.33
		Ni or Co-based cast	320				10-55	0.09-0.30	0.20-0.33
	Titanium alloys	Pure titanium	200	AP301U(N)			30-60	0.09-0.30	0.20-0.33
		α alloys	375				30-60	0.09-0.30	0.20-0.33
α and β alloys		375	30-60				0.09-0.30	0.20-0.33	
	β alloys	410	30-60	0.09-0.30	0.20-0.33				
H	Hardened steel	Hardened and tempered	43-47 HRC						
	Hardened cast iron		47-60 HRC						

*) Insert position-P, I, C
P=peripheral insert, I=intermediate insert, C=center insert

Recommended Cutting Speed for Materials(Dia ≥63.50mm)

	Workpiece material		Brinell hardness (HB)	Grade			Cutting speed Vc m/min	Feed fn mm/r	
				Insert				Drilling dia mm	
				P	I	C		≥ 63.50	
P	Unalloyed steel	C=0.05-0.10%	125	AP301U(N)			80-100	0.18-0.35	
		C=0.10-0.25%	125				80-100	0.18-0.35	
		C=0.25-0.55%	150				80-100	0.18-0.35	
		C=0.55-0.80%	170				80-100	0.18-0.35	
	High carbon steel	Carbon tool steel	210	AP301U(N)			70-100	0.18-0.35	
	Low-alloyed steel	Non-Hardened		180	AP301U(N)			60-100	0.16-0.35
		Tempered		275				70-100	0.18-0.30
		Tempered		350				70-100	0.18-0.30
	High-alloyed steel	Annealed		200	AP301U(N)			60-100	0.16-0.30
		Hardened tool steel		325				60-100	0.16-0.30
Cast steel	Non-alloyed steel		180	AP301U(N)			50-100	0.15-0.30	
	Low-alloy (alloy<5%)		200				50-100	0.15-0.30	
M	Stainless steel	Non-Hardened/Ferritic/martensitic		200	AP301U(N)			50-90	0.16-0.35
		Austenitic		200				50-90	0.16-0.35
		Austenitic, precipitation hardened (PH)		300					
		Austenitic/ferritic, duplex		230					
K	Malleable cast iron	Ferritic		200	AP301U(N)				
		Pearlitic		260					
	Grey cast iron	Low tensile strength		180	AP301U(N)				
		High tensile strength		245					
	Nodular cast iron	Ferritic		160	AP301U(N)				
		Pearlitic		250					
		GGV (CGI)		230					
N	Wrought aluminium alloys	non-aging		30	AP301U(N)			65-130	0.10-0.30
		aged		100				65-130	0.10-0.30
	Cast aluminium alloys	≤ 12% Si, non-aging		75	AP301U(N)			65-130	0.10-0.30
		≤ 12% Si, aged		90				65-130	0.10-0.30
		> 12% Si, non-aging		130				65-130	0.10-0.30
	Magnesium alloy			70					
	Copper and copper alloys (bronze/brass)	Unalloyed, electrolytic copper		100	AP301U(N)			65-130	0.10-0.30
		Brass, bronze, red brass		90				65-130	0.10-0.30
Cu alloys, short-chip		110	65-130	0.10-0.30					
High tensile, Ampco alloy		300	65-130	0.10-0.30					
S	Heat-resistant alloys	Fe-based annealed		200	AP301U(N)			20-65	0.15-0.30
		Fe-based hardened		280				20-65	0.15-0.30
		Ni or Co-based annealed		250				20-65	0.15-0.30
		Ni or Co-based hardened		350				20-65	0.15-0.30
		Ni or Co-based cast		320					
	Titanium alloys	Pure titanium		200	AP301U(N)			30-100	0.15-0.30
α alloys		375	30-100	0.15-0.30					
α and β alloys		375	30-100	0.15-0.30					
β alloys		410	30-100	0.15-0.30					
H	Hardened steel	Hardened and tempered		43-47 HRC					
	Hardened cast iron			47-60 HRC					

*) Insert position-P, I, C
P=peripheral insert, I=intermediate insert, C=center insert

Drilling inserts

ACHTTECK

www.achtecktool.com

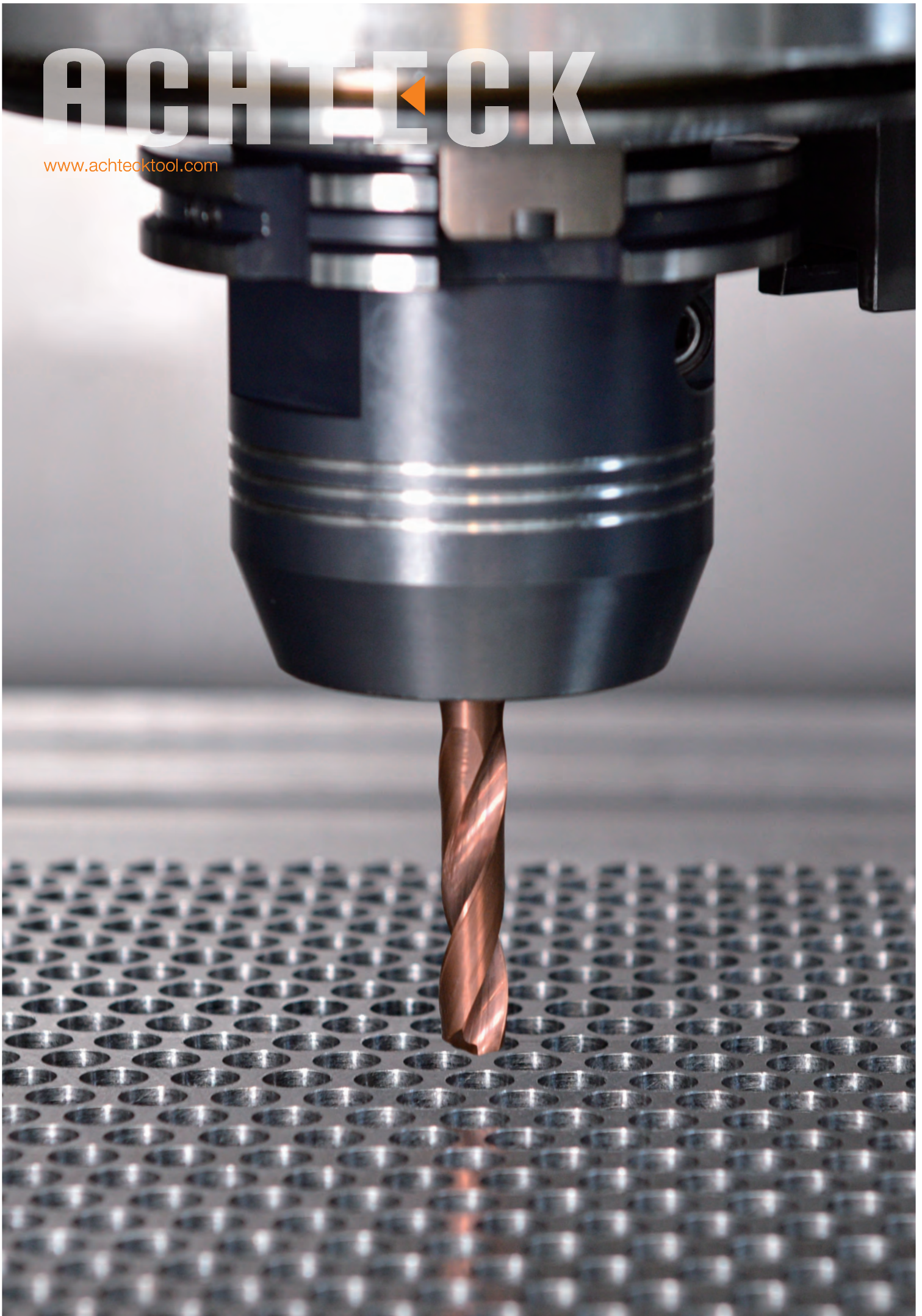

CUTTING TOOL CATALOGUE

Solid carbide drill	286
Drilling tools denomination system	288
Product range	289
Cutting data	305
Thread pilot hole diameters-tapping	307
Thread pilot hole diameters- forming	308

Drilling Tools Denomination System

D	1	06	-	03	-	03000	A	1	AP30P1	U
1	2	3	-	4	-	5	6	7	8	9

1-Tool group	
D	Drilling

2-Generation	
1	

3-Tool type	
06	Universal

4-Drilling depth	
03	~ 3 x Dc in accordance with DIN 6537K
05	~ 5 x Dc in accordance with DIN 6537L

5-Cutting diameter	
03000	3.0mm
12100	12.1mm



6-Shank type	
A	DIN 6535 HA cylindrical shank



7-Coolant	
0	External coolant
1	internal coolant

8-Grade	
AP30P1	

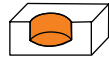
9-Application range	
U	Universal machining P.K.N

Product Overview

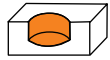
External coolant		
Machining application		
	① Through Hole	② Blind Hole
Drilling depth	3xDc	5xDc
Series	D106	D106
Standard	DIN 6537 K	DIN 6537 L
Dia. Range(mm)	3~16	3~16
Stock items	P289-P292	P293-P296
		

Internal coolant		
Machining application		
	① Through Hole	② Blind Hole
Drilling depth	3xDc	5xDc
Series	D106	D106
Standard	DIN 6537 K	DIN 6537 L
Dia. Range(mm)	3~16	3~16
Stock items	P297-P300	P301-P304
		

Solid Carbide Drill D106 with External Coolant - 3xDc

P	M	S	K	H	N	O
••			••		••	•

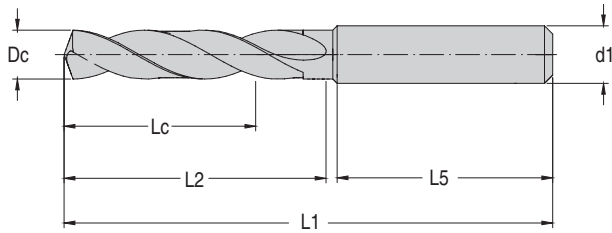

Product code	Dc(m7) mm	Dc inch/No.	Lc mm	L1 mm	L2 mm	L5 mm	d1(h6) mm	stock
D106-03-03000A0 AP30P1U	3		14	62	20	36	4	●
D106-03-03100A0 AP30P1U	3.1		14	62	20	36	4	●
D106-03-03175A0 AP30P1U	3.175	1/8"	14	62	20	36	4	○
D106-03-03200A0 AP30P1U	3.2		14	62	20	36	4	●
D106-03-03250A0 AP30P1U	3.25		14	62	20	36	4	○
D106-03-03300A0 AP30P1U	3.3		14	62	20	36	4	●
D106-03-03400A0 AP30P1U	3.4		14	62	20	36	4	○
D106-03-03500A0 AP30P1U	3.5		14	62	20	36	4	●
D106-03-03572A0 AP30P1U	3.572	9/64"	14	62	20	36	4	○
D106-03-03600A0 AP30P1U	3.6		14	62	20	36	4	●
D106-03-03650A0 AP30P1U	3.65		14	62	20	36	4	○
D106-03-03700A0 AP30P1U	3.7		14	62	20	36	4	●
D106-03-03800A0 AP30P1U	3.8		17	66	24	36	4	○
D106-03-03900A0 AP30P1U	3.9		17	66	24	36	4	●
D106-03-03969A0 AP30P1U	3.969	5/32"	17	66	24	36	4	○
D106-03-04000A0 AP30P1U	4		17	66	24	36	4	●
D106-03-04100A0 AP30P1U	4.1		17	66	24	36	6	○
D106-03-04200A0 AP30P1U	4.2		17	66	24	36	6	●
D106-03-04300A0 AP30P1U	4.3		17	66	24	36	6	○
D106-03-04366A0 AP30P1U	4.366	11/64"	17	66	24	36	6	○
D106-03-04400A0 AP30P1U	4.4		17	66	24	36	6	○
D106-03-04500A0 AP30P1U	4.5		17	66	24	36	6	●
D106-03-04600A0 AP30P1U	4.6		17	66	24	36	6	○
D106-03-04650A0 AP30P1U	4.65		17	66	24	36	6	○
D106-03-04700A0 AP30P1U	4.7		17	66	24	36	6	○
D106-03-04763A0 AP30P1U	4.763	3/16"	20	66	28	36	6	○
D106-03-04800A0 AP30P1U	4.8		20	66	28	36	6	●
D106-03-04900A0 AP30P1U	4.9		20	66	28	36	6	●
D106-03-05000A0 AP30P1U	5		20	66	28	36	6	●
D106-03-05100A0 AP30P1U	5.1		20	66	28	36	6	●
D106-03-05159A0 AP30P1U	5.159	13/64"	20	66	28	36	6	○
D106-03-05200A0 AP30P1U	5.2		20	66	28	36	6	●
D106-03-05300A0 AP30P1U	5.3		20	66	28	36	6	○
D106-03-05400A0 AP30P1U	5.4		20	66	28	36	6	○
D106-03-05500A0 AP30P1U	5.5		20	66	28	36	6	●
D106-03-05550A0 AP30P1U	5.55		20	66	28	36	6	○

Marked : ● Stock available ○ Non-stocked standard

Solid Carbide Drill

Solid Carbide Drill D106 with External Coolant - 3xDc

P	M	S	K	H	N	O
••			••		••	•

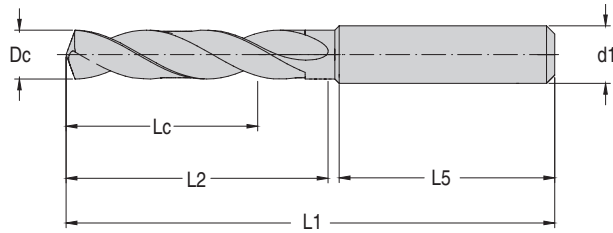

Product code	Dc(m7) mm	Dc inch/No.	Lc mm	L1 mm	L2 mm	L5 mm	d1(h6) mm	stock
D106-03-05556A0 AP30P1U	5.556	7/32"	20	66	28	36	6	○
D106-03-05600A0 AP30P1U	5.6		20	66	28	36	6	○
D106-03-05700A0 AP30P1U	5.7		20	66	28	36	6	○
D106-03-05800A0 AP30P1U	5.8		20	66	28	36	6	●
D106-03-05900A0 AP30P1U	5.9		20	66	28	36	6	●
D106-03-05953A0 AP30P1U	5.953	15/64"	20	66	28	36	6	○
D106-03-06000A0 AP30P1U	6		20	66	28	36	6	●
D106-03-06100A0 AP30P1U	6.1		24	79	41	36	8	○
D106-03-06200A0 AP30P1U	6.2		24	79	41	36	8	○
D106-03-06300A0 AP30P1U	6.3		24	79	41	36	8	○
D106-03-06350A0 AP30P1U	6.35	1/4"	24	79	41	36	8	○
D106-03-06400A0 AP30P1U	6.4		24	79	41	36	8	○
D106-03-06500A0 AP30P1U	6.5		24	79	41	36	8	●
D106-03-06600A0 AP30P1U	6.6		24	79	41	36	8	○
D106-03-06700A0 AP30P1U	6.7		24	79	41	36	8	○
D106-03-06747A0 AP30P1U	6.747	17/64"	24	79	41	36	8	○
D106-03-06800A0 AP30P1U	6.8		24	79	41	36	8	●
D106-03-06900A0 AP30P1U	6.9		24	79	41	36	8	●
D106-03-07000A0 AP30P1U	7		24	79	41	36	8	●
D106-03-07100A0 AP30P1U	7.1		29	79	41	36	8	○
D106-03-07144A0 AP30P1U	7.144	9/32"	29	79	41	36	8	○
D106-03-07200A0 AP30P1U	7.2		29	79	41	36	8	○
D106-03-07300A0 AP30P1U	7.3		29	79	41	36	8	○
D106-03-07400A0 AP30P1U	7.4		29	79	41	36	8	●
D106-03-07500A0 AP30P1U	7.5		29	79	41	36	8	●
D106-03-07541A0 AP30P1U	7.541	19/64"	29	79	41	36	8	○
D106-03-07550A0 AP30P1U	7.55		29	79	41	36	8	○
D106-03-07600A0 AP30P1U	7.6		29	79	41	36	8	○
D106-03-07700A0 AP30P1U	7.7		29	79	41	36	8	○
D106-03-07800A0 AP30P1U	7.8		29	79	41	36	8	●
D106-03-07900A0 AP30P1U	7.9		29	79	41	36	8	●
D106-03-07938A0 AP30P1U	7.938	5/16"	29	79	41	36	8	○
D106-03-08000A0 AP30P1U	8		29	79	41	36	8	●
D106-03-08100A0 AP30P1U	8.1		35	89	47	40	10	○
D106-03-08200A0 AP30P1U	8.2		35	89	47	40	10	○
D106-03-08300A0 AP30P1U	8.3		35	89	47	40	10	○
D106-03-08334A0 AP30P1U	8.334	21/64"	35	89	47	40	10	○
D106-03-08400A0 AP30P1U	8.4		35	89	47	40	10	○
D106-03-08500A0 AP30P1U	8.5		35	89	47	40	10	●
D106-03-08600A0 AP30P1U	8.6		35	89	47	40	10	●
D106-03-08700A0 AP30P1U	8.7		35	89	47	40	10	○
D106-03-08731A0 AP30P1U	8.731	11/32"	35	89	47	40	10	○
D106-03-08800A0 AP30P1U	8.8		35	89	47	40	10	●
D106-03-08900A0 AP30P1U	8.9		35	89	47	40	10	●

Marked : ● Stock available ○ Non-stocked standard

Solid Carbide Drill D106 with External Coolant - 3xDc

P	M	S	K	H	N	O
••			••		••	•

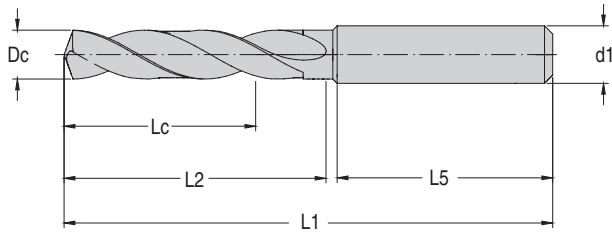

Product code	Dc(m7) mm	Dc inch/No.	Lc mm	L1 mm	L2 mm	L5 mm	d1(h6) mm	stock
D106-03-09000A0 AP30P1U	9		35	89	47	40	10	●
D106-03-09100A0 AP30P1U	9.1		35	89	47	40	10	○
D106-03-09128A0 AP30P1U	9.128	23/64"	35	89	47	40	10	○
D106-03-09200A0 AP30P1U	9.2		35	89	47	40	10	○
D106-03-09300A0 AP30P1U	9.3		35	89	47	40	10	●
D106-03-09400A0 AP30P1U	9.4		35	89	47	40	10	○
D106-03-09500A0 AP30P1U	9.5		35	89	47	40	10	○
D106-03-09525A0 AP30P1U	9.525	3/8"	35	89	47	40	10	○
D106-03-09550A0 AP30P1U	9.55		35	89	47	40	10	○
D106-03-09600A0 AP30P1U	9.6		35	89	47	40	10	○
D106-03-09700A0 AP30P1U	9.7		35	89	47	40	10	○
D106-03-09800A0 AP30P1U	9.8		35	89	47	40	10	●
D106-03-09900A0 AP30P1U	9.9		35	89	47	40	10	●
D106-03-09922A0 AP30P1U	9.922	25/64"	35	89	47	40	10	○
D106-03-10000A0 AP30P1U	10		35	89	47	40	10	●
D106-03-10100A0 AP30P1U	10.1		40	102	55	45	12	●
D106-03-10200A0 AP30P1U	10.2		40	102	55	45	12	●
D106-03-10300A0 AP30P1U	10.3		40	102	55	45	12	●
D106-03-10319A0 AP30P1U	10.319	13/32"	40	102	55	45	12	○
D106-03-10400A0 AP30P1U	10.4		40	102	55	45	12	○
D106-03-10500A0 AP30P1U	10.5		40	102	55	45	12	●
D106-03-10600A0 AP30P1U	10.6		40	102	55	45	12	●
D106-03-10700A0 AP30P1U	10.7		40	102	55	45	12	○
D106-03-10716A0 AP30P1U	10.716	27/64"	40	102	55	45	12	○
D106-03-10800A0 AP30P1U	10.8		40	102	55	45	12	●
D106-03-10900A0 AP30P1U	10.9		40	102	55	45	12	○
D106-03-11000A0 AP30P1U	11		40	102	55	45	12	●
D106-03-11100A0 AP30P1U	11.1		40	102	55	45	12	○
D106-03-11113A0 AP30P1U	11.113	7/16"	40	102	55	45	12	○
D106-03-11200A0 AP30P1U	11.2		40	102	55	45	12	○
D106-03-11300A0 AP30P1U	11.3		40	102	55	45	12	○
D106-03-11400A0 AP30P1U	11.4		40	102	55	45	12	○
D106-03-11500A0 AP30P1U	11.5		40	102	55	45	12	○
D106-03-11509A0 AP30P1U	11.509	29/64"	40	102	55	45	12	○
D106-03-11550A0 AP30P1U	11.55		40	102	55	45	12	○
D106-03-11600A0 AP30P1U	11.6		40	102	55	45	12	○
D106-03-11700A0 AP30P1U	11.7		40	102	55	45	12	○
D106-03-11800A0 AP30P1U	11.8		40	102	55	45	12	●
D106-03-11900A0 AP30P1U	11.9		40	102	55	45	12	○
D106-03-11906A0 AP30P1U	11.906	15/32"	40	102	55	45	12	○
D106-03-12000A0 AP30P1U	12		40	102	55	45	12	●
D106-03-12100A0 AP30P1U	12.1		43	107	60	45	14	○
D106-03-12200A0 AP30P1U	12.2		43	107	60	45	14	○
D106-03-12250A0 AP30P1U	12.25		43	107	60	45	14	○

Solid Carbide Drill

Marked : ● Stock available ○ Non-stocked standard

Solid Carbide Drill D106 with External Coolant - 3xDc

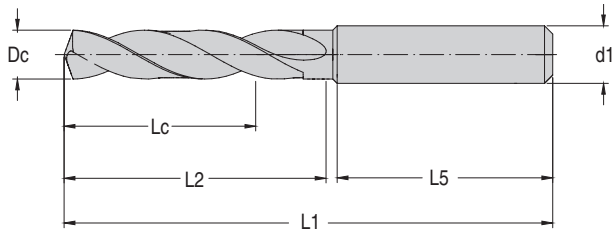

Product code	Dc(m7) mm	Dc inch/No.	Lc mm	L1 mm	L2 mm	L5 mm	d1(h6) mm	stock
D106-03-12300A0 AP30P1U	12.3		43	107	60	45	14	○
D106-03-12303A0 AP30P1U	12.303	31/64"	43	107	60	45	14	○
D106-03-12400A0 AP30P1U	12.4		43	107	60	45	14	○
D106-03-12500A0 AP30P1U	12.5		43	107	60	45	14	●
D106-03-12600A0 AP30P1U	12.6		43	107	60	45	14	○
D106-03-12700A0 AP30P1U	12.7	1/2"	43	107	60	45	14	○
D106-03-12750A0 AP30P1U	12.75		43	107	60	45	14	○
D106-03-12800A0 AP30P1U	12.8		43	107	60	45	14	○
D106-03-12900A0 AP30P1U	12.9		43	107	60	45	14	○
D106-03-13000A0 AP30P1U	13		43	107	60	45	14	●
D106-03-13100A0 AP30P1U	13.1		43	107	60	45	14	○
D106-03-13200A0 AP30P1U	13.2		43	107	60	45	14	●
D106-03-13300A0 AP30P1U	13.3		43	107	60	45	14	○
D106-03-13400A0 AP30P1U	13.4		43	107	60	45	14	○
D106-03-13494A0 AP30P1U	13.494	17/32"	43	107	60	45	14	○
D106-03-13500A0 AP30P1U	13.5		43	107	60	45	14	○
D106-03-13600A0 AP30P1U	13.6		43	107	60	45	14	○
D106-03-13700A0 AP30P1U	13.7		43	107	60	45	14	○
D106-03-13800A0 AP30P1U	13.8		43	107	60	45	14	○
D106-03-13900A0 AP30P1U	13.9		43	107	60	45	14	○
D106-03-14000A0 AP30P1U	14		43	107	60	45	14	●
D106-03-14100A0 AP30P1U	14.1		45	115	65	48	16	●
D106-03-14200A0 AP30P1U	14.2		45	115	65	48	16	●
D106-03-14288A0 AP30P1U	14.288	9/16"	45	115	65	48	16	○
D106-03-14300A0 AP30P1U	14.3		45	115	65	48	16	○
D106-03-14400A0 AP30P1U	14.4		45	115	65	48	16	○
D106-03-14500A0 AP30P1U	14.5		45	115	65	48	16	●
D106-03-14600A0 AP30P1U	14.6		45	115	65	48	16	●
D106-03-14700A0 AP30P1U	14.7		45	115	65	48	16	●
D106-03-14750A0 AP30P1U	14.75		45	115	65	48	16	○
D106-03-14800A0 AP30P1U	14.8		45	115	65	48	16	○
D106-03-15000A0 AP30P1U	15		45	115	65	48	16	●
D106-03-15100A0 AP30P1U	15.1		45	115	65	48	16	○
D106-03-15200A0 AP30P1U	15.2		45	115	65	48	16	○
D106-03-15300A0 AP30P1U	15.3		45	115	65	48	16	○
D106-03-15500A0 AP30P1U	15.5		45	115	65	48	16	●
D106-03-15600A0 AP30P1U	15.6		45	115	65	48	16	○
D106-03-15700A0 AP30P1U	15.7		45	115	65	48	16	●
D106-03-15800A0 AP30P1U	15.8		45	115	65	48	16	●
D106-03-15875A0 AP30P1U	15.875	5/8"	45	115	65	48	16	○
D106-03-15900A0 AP30P1U	15.9		45	115	65	48	16	○
D106-03-16000A0 AP30P1U	16		45	115	65	48	16	●

Marked : ● Stock available ○ Non-stocked standard

Solid Carbide Drill D106 with External Coolant - 5xDc

P	M	S	K	H	N	O
••			••		••	•

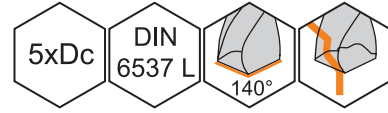
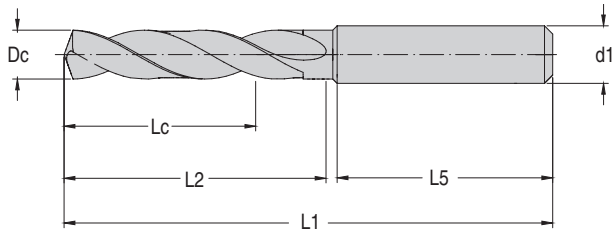

Product code	Dc(m7) mm	Dc inch/No.	Lc mm	L1 mm	L2 mm	L5 mm	d1(h6) mm	stock
D106-05-03000A0 AP30P1U	3		23	66	28	36	4	●
D106-05-03100A0 AP30P1U	3.1		23	66	28	36	4	●
D106-05-03175A0 AP30P1U	3.175	1/8"	23	66	28	36	4	○
D106-05-03200A0 AP30P1U	3.2		23	66	28	36	4	●
D106-05-03250A0 AP30P1U	3.25		23	66	28	36	4	○
D106-05-03300A0 AP30P1U	3.3		23	66	28	36	4	●
D106-05-03400A0 AP30P1U	3.4		23	66	28	36	4	○
D106-05-03500A0 AP30P1U	3.5		23	66	28	36	4	●
D106-05-03572A0 AP30P1U	3.572	9/64"	23	66	28	36	4	○
D106-05-03600A0 AP30P1U	3.6		23	66	28	36	4	●
D106-05-03650A0 AP30P1U	3.65		23	66	28	36	4	○
D106-05-03700A0 AP30P1U	3.7		23	66	28	36	4	●
D106-05-03800A0 AP30P1U	3.8		29	74	36	36	4	○
D106-05-03900A0 AP30P1U	3.9		29	74	36	36	4	●
D106-05-03969A0 AP30P1U	3.969	5/32"	29	74	36	36	4	○
D106-05-04000A0 AP30P1U	4		29	74	36	36	4	●
D106-05-04100A0 AP30P1U	4.1		29	74	36	36	6	○
D106-05-04200A0 AP30P1U	4.2		29	74	36	36	6	●
D106-05-04300A0 AP30P1U	4.3		29	74	36	36	6	○
D106-05-04366A0 AP30P1U	4.366	11/64"	29	74	36	36	6	○
D106-05-04400A0 AP30P1U	4.4		29	74	36	36	6	○
D106-05-04500A0 AP30P1U	4.5		29	74	36	36	6	●
D106-05-04600A0 AP30P1U	4.6		29	74	36	36	6	○
D106-05-04650A0 AP30P1U	4.65		29	74	36	36	6	○
D106-05-04700A0 AP30P1U	4.7		29	74	36	36	6	○
D106-05-04763A0 AP30P1U	4.763	3/16"	35	82	44	36	6	○
D106-05-04800A0 AP30P1U	4.8		35	82	44	36	6	●
D106-05-04900A0 AP30P1U	4.9		35	82	44	36	6	●
D106-05-05000A0 AP30P1U	5		35	82	44	36	6	●
D106-05-05100A0 AP30P1U	5.1		35	82	44	36	6	●
D106-05-05159A0 AP30P1U	5.159	13/64"	35	82	44	36	6	○
D106-05-05200A0 AP30P1U	5.2		35	82	44	36	6	●
D106-05-05300A0 AP30P1U	5.3		35	82	44	36	6	○
D106-05-05400A0 AP30P1U	5.4		35	82	44	36	6	○
D106-05-05500A0 AP30P1U	5.5		35	82	44	36	6	●
D106-05-05550A0 AP30P1U	5.55		35	82	44	36	6	○

Marked : ● Stock available ○ Non-stocked standard

Solid Carbide Drill

Solid Carbide Drill D106 with External Coolant - 5xDc

P	M	S	K	H	N	O
••			••		••	•

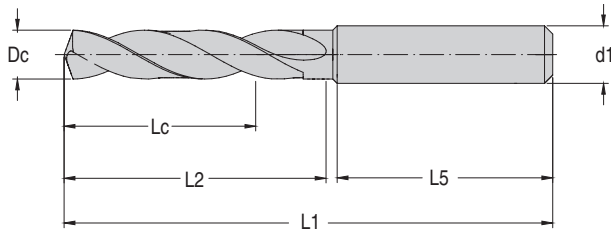

Product code	Dc(m7) mm	Dc inch/No.	Lc mm	L1 mm	L2 mm	L5 mm	d1(h6) mm	stock
D106-05-05556A0 AP30P1U	5.556	7/32"	35	82	44	36	6	○
D106-05-05600A0 AP30P1U	5.6		35	82	44	36	6	○
D106-05-05700A0 AP30P1U	5.7		35	82	44	36	6	○
D106-05-05800A0 AP30P1U	5.8		35	82	44	36	6	●
D106-05-05900A0 AP30P1U	5.9		35	82	44	36	6	●
D106-05-05953A0 AP30P1U	5.953	15/64"	35	82	44	36	6	○
D106-05-06000A0 AP30P1U	6		35	82	44	36	6	●
D106-05-06100A0 AP30P1U	6.1		43	91	53	36	8	○
D106-05-06200A0 AP30P1U	6.2		43	91	53	36	8	○
D106-05-06300A0 AP30P1U	6.3		43	91	53	36	8	○
D106-05-06350A0 AP30P1U	6.35	1/4"	43	91	53	36	8	○
D106-05-06400A0 AP30P1U	6.4		43	91	53	36	8	○
D106-05-06500A0 AP30P1U	6.5		43	91	53	36	8	●
D106-05-06600A0 AP30P1U	6.6		43	91	53	36	8	○
D106-05-06700A0 AP30P1U	6.7		43	91	53	36	8	○
D106-05-06747A0 AP30P1U	6.747	17/64"	43	91	53	36	8	○
D106-05-06800A0 AP30P1U	6.8		43	91	53	36	8	●
D106-05-06900A0 AP30P1U	6.9		43	91	53	36	8	●
D106-05-07000A0 AP30P1U	7		43	91	53	36	8	●
D106-05-07100A0 AP30P1U	7.1		43	91	53	36	8	○
D106-05-07144A0 AP30P1U	7.144	9/32"	43	91	53	36	8	○
D106-05-07200A0 AP30P1U	7.2		43	91	53	36	8	○
D106-05-07300A0 AP30P1U	7.3		43	91	53	36	8	○
D106-05-07400A0 AP30P1U	7.4		43	91	53	36	8	●
D106-05-07500A0 AP30P1U	7.5		43	91	53	36	8	●
D106-05-07541A0 AP30P1U	7.541	19/64"	43	91	53	36	8	○
D106-05-07550A0 AP30P1U	7.55		43	91	53	36	8	○
D106-05-07600A0 AP30P1U	7.6		43	91	53	36	8	○
D106-05-07700A0 AP30P1U	7.7		43	91	53	36	8	○
D106-05-07800A0 AP30P1U	7.8		43	91	53	36	8	●
D106-05-07900A0 AP30P1U	7.9		43	91	53	36	8	●
D106-05-07938A0 AP30P1U	7.938	5/16"	43	91	53	36	8	○
D106-05-08000A0 AP30P1U	8		43	91	53	36	8	●
D106-05-08100A0 AP30P1U	8.1		49	103	61	40	10	○
D106-05-08200A0 AP30P1U	8.2		49	103	61	40	10	○
D106-05-08300A0 AP30P1U	8.3		49	103	61	40	10	○
D106-05-08334A0 AP30P1U	8.334	21/64"	49	103	61	40	10	○
D106-05-08400A0 AP30P1U	8.4		49	103	61	40	10	○
D106-05-08500A0 AP30P1U	8.5		49	103	61	40	10	●
D106-05-08600A0 AP30P1U	8.6		49	103	61	40	10	●
D106-05-08700A0 AP30P1U	8.7		49	103	61	40	10	○
D106-05-08731A0 AP30P1U	8.731	11/32"	49	103	61	40	10	○
D106-05-08800A0 AP30P1U	8.8		49	103	61	40	10	●
D106-05-08900A0 AP30P1U	8.9		49	103	61	40	10	●

Marked : ● Stock available ○ Non-stocked standard

Solid Carbide Drill D106 with External Coolant - 5xDc

P	M	S	K	H	N	O
••			••		••	•

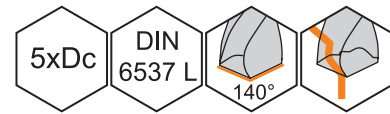
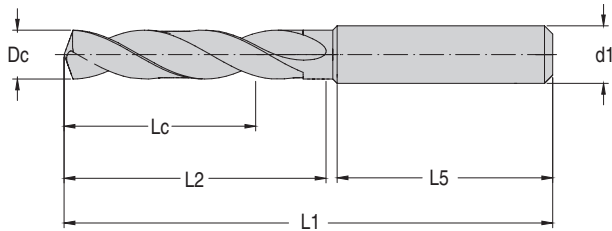

Product code	Dc(m7) mm	Dc inch/No.	Lc mm	L1 mm	L2 mm	L5 mm	d1(h6) mm	stock
D106-05-09000A0 AP30P1U	9		49	103	61	40	10	●
D106-05-09100A0 AP30P1U	9.1		49	103	61	40	10	○
D106-05-09128A0 AP30P1U	9.128	23/64"	49	103	61	40	10	○
D106-05-09200A0 AP30P1U	9.2		49	103	61	40	10	○
D106-05-09300A0 AP30P1U	9.3		49	103	61	40	10	●
D106-05-09400A0 AP30P1U	9.4		49	103	61	40	10	○
D106-05-09500A0 AP30P1U	9.5		49	103	61	40	10	○
D106-05-09525A0 AP30P1U	9.525	3/8"	49	103	61	40	10	○
D106-05-09550A0 AP30P1U	9.55		49	103	61	40	10	○
D106-05-09600A0 AP30P1U	9.6		49	103	61	40	10	○
D106-05-09700A0 AP30P1U	9.7		49	103	61	40	10	○
D106-05-09800A0 AP30P1U	9.8		49	103	61	40	10	●
D106-05-09900A0 AP30P1U	9.9		49	103	61	40	10	●
D106-05-09922A0 AP30P1U	9.922	25/64"	49	103	61	40	10	○
D106-05-10000A0 AP30P1U	10		49	103	61	40	10	●
D106-05-10100A0 AP30P1U	10.1		56	118	71	45	12	●
D106-05-10200A0 AP30P1U	10.2		56	118	71	45	12	●
D106-05-10300A0 AP30P1U	10.3		56	118	71	45	12	●
D106-05-10319A0 AP30P1U	10.319	13/32"	56	118	71	45	12	○
D106-05-10400A0 AP30P1U	10.4		56	118	71	45	12	○
D106-05-10500A0 AP30P1U	10.5		56	118	71	45	12	●
D106-05-10600A0 AP30P1U	10.6		56	118	71	45	12	●
D106-05-10700A0 AP30P1U	10.7		56	118	71	45	12	○
D106-05-10716A0 AP30P1U	10.716	27/64"	56	118	71	45	12	○
D106-05-10800A0 AP30P1U	10.8		56	118	71	45	12	●
D106-05-10900A0 AP30P1U	10.9		56	118	71	45	12	○
D106-05-11000A0 AP30P1U	11		56	118	71	45	12	●
D106-05-11100A0 AP30P1U	11.1		56	118	71	45	12	○
D106-05-11113A0 AP30P1U	11.113	7/16"	56	118	71	45	12	○
D106-05-11200A0 AP30P1U	11.2		56	118	71	45	12	○
D106-05-11300A0 AP30P1U	11.3		56	118	71	45	12	○
D106-05-11400A0 AP30P1U	11.4		56	118	71	45	12	○
D106-05-11500A0 AP30P1U	11.5		56	118	71	45	12	○
D106-05-11509A0 AP30P1U	11.509	29/64"	56	118	71	45	12	○
D106-05-11550A0 AP30P1U	11.55		56	118	71	45	12	○
D106-05-11600A0 AP30P1U	11.6		56	118	71	45	12	○
D106-05-11700A0 AP30P1U	11.7		56	118	71	45	12	○
D106-05-11800A0 AP30P1U	11.8		56	118	71	45	12	●
D106-05-11900A0 AP30P1U	11.9		56	118	71	45	12	○
D106-05-11906A0 AP30P1U	11.906	15/32"	56	118	71	45	12	○
D106-05-12000A0 AP30P1U	12		56	118	71	45	12	●
D106-05-12100A0 AP30P1U	12.1		60	124	77	45	14	○
D106-05-12200A0 AP30P1U	12.2		60	124	77	45	14	○
D106-05-12250A0 AP30P1U	12.25		60	124	77	45	14	○

Marked : ● Stock available ○ Non-stocked standard

Solid Carbide Drill

Solid Carbide Drill D106 with External Coolant - 5xDc

P	M	S	K	H	N	O
••			••		••	•

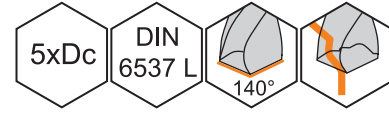
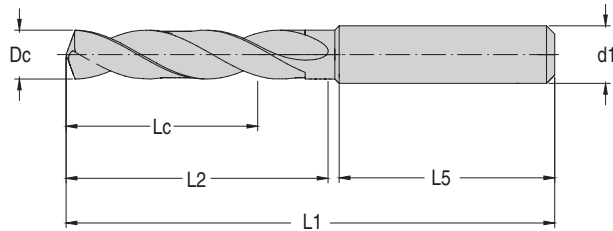

Product code	Dc(m7) mm	Dc inch/No.	Lc mm	L1 mm	L2 mm	L5 mm	d1(h6) mm	stock
D106-05-12300A0 AP30P1U	12.3		60	124	77	45	14	○
D106-05-12303A0 AP30P1U	12.303	31/64"	60	124	77	45	14	○
D106-05-12400A0 AP30P1U	12.4		60	124	77	45	14	○
D106-05-12500A0 AP30P1U	12.5		60	124	77	45	14	●
D106-05-12600A0 AP30P1U	12.6		60	124	77	45	14	○
D106-05-12700A0 AP30P1U	12.7	1/2"	60	124	77	45	14	○
D106-05-12750A0 AP30P1U	12.75		60	124	77	45	14	○
D106-05-12800A0 AP30P1U	12.8		60	124	77	45	14	○
D106-05-12900A0 AP30P1U	12.9		60	124	77	45	14	○
D106-05-13000A0 AP30P1U	13		60	124	77	45	14	●
D106-05-13100A0 AP30P1U	13.1		60	124	77	45	14	○
D106-05-13200A0 AP30P1U	13.2		60	124	77	45	14	●
D106-05-13300A0 AP30P1U	13.3		60	124	77	45	14	○
D106-05-13400A0 AP30P1U	13.4		60	124	77	45	14	○
D106-05-13494A0 AP30P1U	13.494	17/32"	60	124	77	45	14	○
D106-05-13500A0 AP30P1U	13.5		60	124	77	45	14	○
D106-05-13600A0 AP30P1U	13.6		60	124	77	45	14	○
D106-05-13700A0 AP30P1U	13.7		60	124	77	45	14	●
D106-05-13800A0 AP30P1U	13.8		60	124	77	45	14	○
D106-05-13900A0 AP30P1U	13.9		60	124	77	45	14	○
D106-05-14000A0 AP30P1U	14		60	124	77	45	14	●
D106-05-14100A0 AP30P1U	14.1		63	133	83	48	16	●
D106-05-14200A0 AP30P1U	14.2		63	133	83	48	16	●
D106-05-14288A0 AP30P1U	14.288	9/16"	63	133	83	48	16	○
D106-05-14300A0 AP30P1U	14.3		63	133	83	48	16	○
D106-05-14400A0 AP30P1U	14.4		63	133	83	48	16	○
D106-05-14500A0 AP30P1U	14.5		63	133	83	48	16	●
D106-05-14600A0 AP30P1U	14.6		63	133	83	48	16	●
D106-05-14700A0 AP30P1U	14.7		63	133	83	48	16	●
D106-05-14750A0 AP30P1U	14.75		63	133	83	48	16	○
D106-05-14800A0 AP30P1U	14.8		63	133	83	48	16	○
D106-05-15000A0 AP30P1U	15		63	133	83	48	16	●
D106-05-15100A0 AP30P1U	15.1		63	133	83	48	16	○
D106-05-15200A0 AP30P1U	15.2		63	133	83	48	16	○
D106-05-15300A0 AP30P1U	15.3		63	133	83	48	16	○
D106-05-15500A0 AP30P1U	15.5		63	133	83	48	16	●
D106-05-15600A0 AP30P1U	15.6		63	133	83	48	16	○
D106-05-15700A0 AP30P1U	15.7		63	133	83	48	16	●
D106-05-15800A0 AP30P1U	15.8		63	133	83	48	16	●
D106-05-15875A0 AP30P1U	15.875	5/8"	63	133	83	48	16	○
D106-05-15900A0 AP30P1U	15.9		63	133	83	48	16	○
D106-05-16000A0 AP30P1U	16		63	133	83	48	16	●

Marked : ● Stock available ○ Non-stocked standard

Solid Carbide Drill D106 with Internal Coolant - 3xDc

P	M	S	K	H	N	O
••	•	•	••	•	••	•

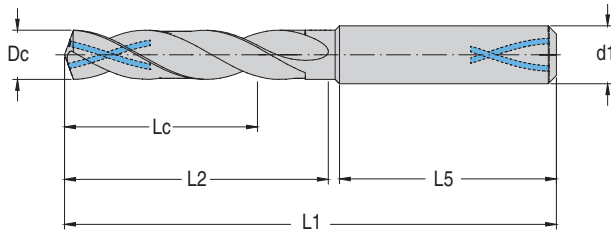

Product code	Dc(m7) mm	Dc inch/No.	Lc mm	L1 mm	L2 mm	L5 mm	d1(h6) mm	stock
D106-03-03000A1 AP30P1U	3		14	62	20	36	4	●
D106-03-03100A1 AP30P1U	3.1		14	62	20	36	4	●
D106-03-03175A1 AP30P1U	3.175	1/8"	14	62	20	36	4	○
D106-03-03200A1 AP30P1U	3.2		14	62	20	36	4	●
D106-03-03250A1 AP30P1U	3.25		14	62	20	36	4	○
D106-03-03300A1 AP30P1U	3.3		14	62	20	36	4	●
D106-03-03400A1 AP30P1U	3.4		14	62	20	36	4	○
D106-03-03500A1 AP30P1U	3.5		14	62	20	36	4	●
D106-03-03572A1 AP30P1U	3.572	9/64"	14	62	20	36	4	○
D106-03-03600A1 AP30P1U	3.6		14	62	20	36	4	●
D106-03-03650A1 AP30P1U	3.65		14	62	20	36	4	○
D106-03-03700A1 AP30P1U	3.7		14	62	20	36	4	●
D106-03-03800A1 AP30P1U	3.8		17	66	24	36	4	○
D106-03-03900A1 AP30P1U	3.9		17	66	24	36	4	●
D106-03-03969A1 AP30P1U	3.969	5/32"	17	66	24	36	4	○
D106-03-04000A1 AP30P1U	4		17	66	24	36	4	●
D106-03-04100A1 AP30P1U	4.1		17	66	24	36	6	○
D106-03-04200A1 AP30P1U	4.2		17	66	24	36	6	●
D106-03-04300A1 AP30P1U	4.3		17	66	24	36	6	○
D106-03-04366A1 AP30P1U	4.366	11/64"	17	66	24	36	6	○
D106-03-04400A1 AP30P1U	4.4		17	66	24	36	6	○
D106-03-04500A1 AP30P1U	4.5		17	66	24	36	6	●
D106-03-04600A1 AP30P1U	4.6		17	66	24	36	6	○
D106-03-04650A1 AP30P1U	4.65		17	66	24	36	6	○
D106-03-04700A1 AP30P1U	4.7		17	66	24	36	6	○
D106-03-04763A1 AP30P1U	4.763	3/16"	20	66	28	36	6	○
D106-03-04800A1 AP30P1U	4.8		20	66	28	36	6	●
D106-03-04900A1 AP30P1U	4.9		20	66	28	36	6	●
D106-03-05000A1 AP30P1U	5		20	66	28	36	6	●
D106-03-05100A1 AP30P1U	5.1		20	66	28	36	6	●
D106-03-05159A1 AP30P1U	5.159	13/64"	20	66	28	36	6	○
D106-03-05200A1 AP30P1U	5.2		20	66	28	36	6	●
D106-03-05300A1 AP30P1U	5.3		20	66	28	36	6	○
D106-03-05400A1 AP30P1U	5.4		20	66	28	36	6	○
D106-03-05500A1 AP30P1U	5.5		20	66	28	36	6	●
D106-03-05550A1 AP30P1U	5.55		20	66	28	36	6	○

Marked : ● Stock available ○ Non-stocked standard

Solid Carbide Drill

Solid Carbide Drill D106 with Internal Coolant - 3xDc

P	M	S	K	H	N	O
••	•	•	••	•	••	•

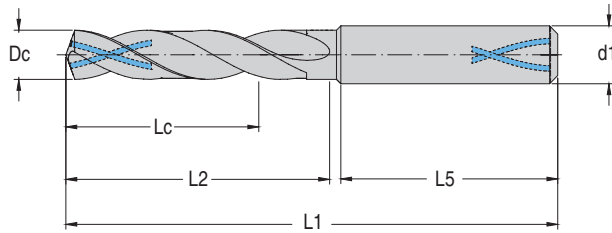

Product code	Dc(m7) mm	Dc inch/No.	Lc mm	L1 mm	L2 mm	L5 mm	d1(h6) mm	stock
D106-03-05556A1 AP30P1U	5.556	7/32"	20	66	28	36	6	○
D106-03-05600A1 AP30P1U	5.6		20	66	28	36	6	○
D106-03-05700A1 AP30P1U	5.7		20	66	28	36	6	○
D106-03-05800A1 AP30P1U	5.8		20	66	28	36	6	●
D106-03-05900A1 AP30P1U	5.9		20	66	28	36	6	●
D106-03-05953A1 AP30P1U	5.953	15/64"	20	66	28	36	6	○
D106-03-06000A1 AP30P1U	6		20	66	28	36	6	●
D106-03-06100A1 AP30P1U	6.1		24	79	41	36	8	○
D106-03-06200A1 AP30P1U	6.2		24	79	41	36	8	○
D106-03-06300A1 AP30P1U	6.3		24	79	41	36	8	○
D106-03-06350A1 AP30P1U	6.35	1/4"	24	79	41	36	8	○
D106-03-06400A1 AP30P1U	6.4		24	79	41	36	8	○
D106-03-06500A1 AP30P1U	6.5		24	79	41	36	8	●
D106-03-06600A1 AP30P1U	6.6		24	79	41	36	8	○
D106-03-06700A1 AP30P1U	6.7		24	79	41	36	8	○
D106-03-06747A1 AP30P1U	6.747	17/64"	24	79	41	36	8	○
D106-03-06800A1 AP30P1U	6.8		24	79	41	36	8	●
D106-03-06900A1 AP30P1U	6.9		24	79	41	36	8	●
D106-03-07000A1 AP30P1U	7		24	79	41	36	8	●
D106-03-07100A1 AP30P1U	7.1		29	79	41	36	8	○
D106-03-07144A1 AP30P1U	7.144	9/32"	29	79	41	36	8	○
D106-03-07200A1 AP30P1U	7.2		29	79	41	36	8	○
D106-03-07300A1 AP30P1U	7.3		29	79	41	36	8	○
D106-03-07400A1 AP30P1U	7.4		29	79	41	36	8	●
D106-03-07500A1 AP30P1U	7.5		29	79	41	36	8	●
D106-03-07541A1 AP30P1U	7.541	19/64"	29	79	41	36	8	○
D106-03-07550A1 AP30P1U	7.55		29	79	41	36	8	○
D106-03-07600A1 AP30P1U	7.6		29	79	41	36	8	○
D106-03-07700A1 AP30P1U	7.7		29	79	41	36	8	○
D106-03-07800A1 AP30P1U	7.8		29	79	41	36	8	●
D106-03-07900A1 AP30P1U	7.9		29	79	41	36	8	●
D106-03-07938A1 AP30P1U	7.938	5/16"	29	79	41	36	8	○
D106-03-08000A1 AP30P1U	8		29	79	41	36	8	●
D106-03-08100A1 AP30P1U	8.1		35	89	47	40	10	○
D106-03-08200A1 AP30P1U	8.2		35	89	47	40	10	○
D106-03-08300A1 AP30P1U	8.3		35	89	47	40	10	○
D106-03-08334A1 AP30P1U	8.334	21/64"	35	89	47	40	10	○
D106-03-08400A1 AP30P1U	8.4		35	89	47	40	10	○
D106-03-08500A1 AP30P1U	8.5		35	89	47	40	10	●
D106-03-08600A1 AP30P1U	8.6		35	89	47	40	10	●
D106-03-08700A1 AP30P1U	8.7		35	89	47	40	10	○
D106-03-08731A1 AP30P1U	8.731	11/32"	35	89	47	40	10	○
D106-03-08800A1 AP30P1U	8.8		35	89	47	40	10	●
D106-03-08900A1 AP30P1U	8.9		35	89	47	40	10	●

Marked : ● Stock available ○ Non-stocked standard

Solid Carbide Drill D106 with Internal Coolant - 3xDc

P	M	S	K	H	N	O
••	•	•	••	•	••	•

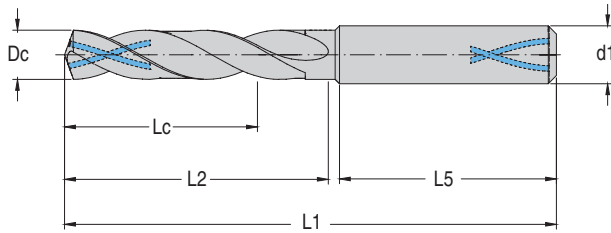

Product code	Dc(m7) mm	Dc inch/No.	Lc mm	L1 mm	L2 mm	L5 mm	d1(h6) mm	stock
D106-03-09000A1 AP30P1U	9		35	89	47	40	10	●
D106-03-09100A1 AP30P1U	9.1		35	89	47	40	10	○
D106-03-09128A1 AP30P1U	9.128	23/64"	35	89	47	40	10	○
D106-03-09200A1 AP30P1U	9.2		35	89	47	40	10	○
D106-03-09300A1 AP30P1U	9.3		35	89	47	40	10	●
D106-03-09400A1 AP30P1U	9.4		35	89	47	40	10	○
D106-03-09500A1 AP30P1U	9.5		35	89	47	40	10	○
D106-03-09525A1 AP30P1U	9.525	3/8"	35	89	47	40	10	○
D106-03-09550A1 AP30P1U	9.55		35	89	47	40	10	○
D106-03-09600A1 AP30P1U	9.6		35	89	47	40	10	○
D106-03-09700A1 AP30P1U	9.7		35	89	47	40	10	○
D106-03-09800A1 AP30P1U	9.8		35	89	47	40	10	●
D106-03-09900A1 AP30P1U	9.9		35	89	47	40	10	●
D106-03-09922A1 AP30P1U	9.922	25/64"	35	89	47	40	10	○
D106-03-10000A1 AP30P1U	10		35	89	47	40	10	●
D106-03-10100A1 AP30P1U	10.1		40	102	55	45	12	●
D106-03-10200A1 AP30P1U	10.2		40	102	55	45	12	●
D106-03-10300A1 AP30P1U	10.3		40	102	55	45	12	●
D106-03-10319A1 AP30P1U	10.319	13/32"	40	102	55	45	12	○
D106-03-10400A1 AP30P1U	10.4		40	102	55	45	12	○
D106-03-10500A1 AP30P1U	10.5		40	102	55	45	12	●
D106-03-10600A1 AP30P1U	10.6		40	102	55	45	12	●
D106-03-10700A1 AP30P1U	10.7		40	102	55	45	12	○
D106-03-10716A1 AP30P1U	10.716	27/64"	40	102	55	45	12	○
D106-03-10800A1 AP30P1U	10.8		40	102	55	45	12	●
D106-03-10900A1 AP30P1U	10.9		40	102	55	45	12	○
D106-03-11000A1 AP30P1U	11		40	102	55	45	12	●
D106-03-11100A1 AP30P1U	11.1		40	102	55	45	12	○
D106-03-11113A1 AP30P1U	11.113	7/16"	40	102	55	45	12	○
D106-03-11200A1 AP30P1U	11.2		40	102	55	45	12	○
D106-03-11300A1 AP30P1U	11.3		40	102	55	45	12	○
D106-03-11400A1 AP30P1U	11.4		40	102	55	45	12	○
D106-03-11500A1 AP30P1U	11.5		40	102	55	45	12	○
D106-03-11509A1 AP30P1U	11.509	29/64"	40	102	55	45	12	○
D106-03-11550A1 AP30P1U	11.55		40	102	55	45	12	○
D106-03-11600A1 AP30P1U	11.6		40	102	55	45	12	○
D106-03-11700A1 AP30P1U	11.7		40	102	55	45	12	○
D106-03-11800A1 AP30P1U	11.8		40	102	55	45	12	●
D106-03-11900A1 AP30P1U	11.9		40	102	55	45	12	○
D106-03-11906A1 AP30P1U	11.906	15/32"	40	102	55	45	12	○
D106-03-12000A1 AP30P1U	12		40	102	55	45	12	●
D106-03-12100A1 AP30P1U	12.1		43	107	60	45	14	○
D106-03-12200A1 AP30P1U	12.2		43	107	60	45	14	○
D106-03-12250A1 AP30P1U	12.25		43	107	60	45	14	○

Marked : ● Stock available ○ Non-stocked standard

Solid Carbide Drill

Solid Carbide Drill D106 with Internal Coolant - 3xDc

P	M	S	K	H	N	O
••	•	•	••	•	••	•

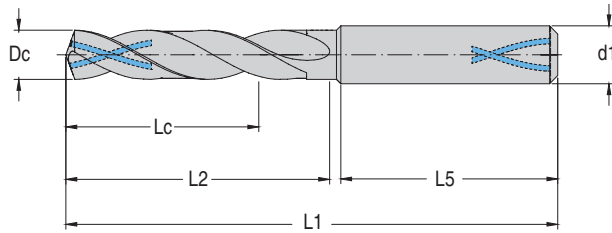

Product code	Dc(m7) mm	Dc inch/No.	Lc mm	L1 mm	L2 mm	L5 mm	d1(h6) mm	stock
D106-03-12300A1 AP30P1U	12.3		43	107	60	45	14	○
D106-03-12303A1 AP30P1U	12.303	31/64"	43	107	60	45	14	○
D106-03-12400A1 AP30P1U	12.4		43	107	60	45	14	○
D106-03-12500A1 AP30P1U	12.5		43	107	60	45	14	●
D106-03-12600A1 AP30P1U	12.6		43	107	60	45	14	○
D106-03-12700A1 AP30P1U	12.7	1/2"	43	107	60	45	14	○
D106-03-12750A1 AP30P1U	12.75		43	107	60	45	14	○
D106-03-12800A1 AP30P1U	12.8		43	107	60	45	14	○
D106-03-12900A1 AP30P1U	12.9		43	107	60	45	14	○
D106-03-13000A1 AP30P1U	13		43	107	60	45	14	●
D106-03-13100A1 AP30P1U	13.1		43	107	60	45	14	○
D106-03-13200A1 AP30P1U	13.2		43	107	60	45	14	●
D106-03-13300A1 AP30P1U	13.3		43	107	60	45	14	○
D106-03-13400A1 AP30P1U	13.4		43	107	60	45	14	○
D106-03-13494A1 AP30P1U	13.494	17/32"	43	107	60	45	14	○
D106-03-13500A1 AP30P1U	13.5		43	107	60	45	14	○
D106-03-13600A1 AP30P1U	13.6		43	107	60	45	14	○
D106-03-13700A1 AP30P1U	13.7		43	107	60	45	14	○
D106-03-13800A1 AP30P1U	13.8		43	107	60	45	14	○
D106-03-13900A1 AP30P1U	13.9		43	107	60	45	14	○
D106-03-14000A1 AP30P1U	14		43	107	60	45	14	●
D106-03-14100A1 AP30P1U	14.1		45	115	65	48	16	●
D106-03-14200A1 AP30P1U	14.2		45	115	65	48	16	●
D106-03-14288A1 AP30P1U	14.288	9/16"	45	115	65	48	16	○
D106-03-14300A1 AP30P1U	14.3		45	115	65	48	16	○
D106-03-14400A1 AP30P1U	14.4		45	115	65	48	16	○
D106-03-14500A1 AP30P1U	14.5		45	115	65	48	16	●
D106-03-14600A1 AP30P1U	14.6		45	115	65	48	16	●
D106-03-14700A1 AP30P1U	14.7		45	115	65	48	16	●
D106-03-14750A1 AP30P1U	14.75		45	115	65	48	16	○
D106-03-14800A1 AP30P1U	14.8		45	115	65	48	16	○
D106-03-15000A1 AP30P1U	15		45	115	65	48	16	●
D106-03-15100A1 AP30P1U	15.1		45	115	65	48	16	○
D106-03-15200A1 AP30P1U	15.2		45	115	65	48	16	○
D106-03-15300A1 AP30P1U	15.3		45	115	65	48	16	○
D106-03-15500A1 AP30P1U	15.5		45	115	65	48	16	●
D106-03-15600A1 AP30P1U	15.6		45	115	65	48	16	○
D106-03-15700A1 AP30P1U	15.7		45	115	65	48	16	●
D106-03-15800A1 AP30P1U	15.8		45	115	65	48	16	●
D106-03-15875A1 AP30P1U	15.875	5/8"	45	115	65	48	16	○
D106-03-15900A1 AP30P1U	15.9		45	115	65	48	16	○
D106-03-16000A1 AP30P1U	16		45	115	65	48	16	●

Marked : ● Stock available ○ Non-stocked standard

Solid Carbide Drill D106 with Internal Coolant - 5xDc

P	M	S	K	H	N	O
••	•	•	••	•	••	•

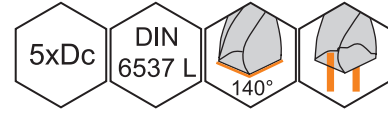
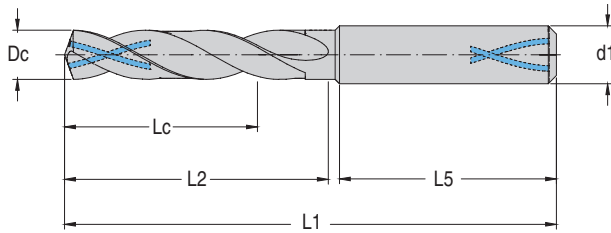

Product code	Dc(m7) mm	Dc inch/No.	Lc mm	L1 mm	L2 mm	L5 mm	d1(h6) mm	stock
D106-05-03000A1 AP30P1U	3		23	66	28	36	4	●
D106-05-03100A1 AP30P1U	3.1		23	66	28	36	4	●
D106-05-03175A1 AP30P1U	3.175	1/8"	23	66	28	36	4	○
D106-05-03200A1 AP30P1U	3.2		23	66	28	36	4	●
D106-05-03250A1 AP30P1U	3.25		23	66	28	36	4	○
D106-05-03300A1 AP30P1U	3.3		23	66	28	36	4	●
D106-05-03400A1 AP30P1U	3.4		23	66	28	36	4	○
D106-05-03500A1 AP30P1U	3.5		23	66	28	36	4	●
D106-05-03572A1 AP30P1U	3.572	9/64"	23	66	28	36	4	○
D106-05-03600A1 AP30P1U	3.6		23	66	28	36	4	●
D106-05-03650A1 AP30P1U	3.65		23	66	28	36	4	○
D106-05-03700A1 AP30P1U	3.7		23	66	28	36	4	●
D106-05-03800A1 AP30P1U	3.8		29	74	36	36	4	○
D106-05-03900A1 AP30P1U	3.9		29	74	36	36	4	●
D106-05-03969A1 AP30P1U	3.969	5/32"	29	74	36	36	4	○
D106-05-04000A1 AP30P1U	4		29	74	36	36	4	●
D106-05-04100A1 AP30P1U	4.1		29	74	36	36	6	○
D106-05-04200A1 AP30P1U	4.2		29	74	36	36	6	●
D106-05-04300A1 AP30P1U	4.3		29	74	36	36	6	○
D106-05-04366A1 AP30P1U	4.366	11/64"	29	74	36	36	6	○
D106-05-04400A1 AP30P1U	4.4		29	74	36	36	6	○
D106-05-04500A1 AP30P1U	4.5		29	74	36	36	6	●
D106-05-04600A1 AP30P1U	4.6		29	74	36	36	6	○
D106-05-04650A1 AP30P1U	4.65		29	74	36	36	6	○
D106-05-04700A1 AP30P1U	4.7		29	74	36	36	6	○
D106-05-04763A1 AP30P1U	4.763	3/16"	35	82	44	36	6	○
D106-05-04800A1 AP30P1U	4.8		35	82	44	36	6	●
D106-05-04900A1 AP30P1U	4.9		35	82	44	36	6	●
D106-05-05000A1 AP30P1U	5		35	82	44	36	6	●
D106-05-05100A1 AP30P1U	5.1		35	82	44	36	6	●
D106-05-05159A1 AP30P1U	5.159	13/64"	35	82	44	36	6	○
D106-05-05200A1 AP30P1U	5.2		35	82	44	36	6	●
D106-05-05300A1 AP30P1U	5.3		35	82	44	36	6	○
D106-05-05400A1 AP30P1U	5.4		35	82	44	36	6	○
D106-05-05500A1 AP30P1U	5.5		35	82	44	36	6	●
D106-05-05550A1 AP30P1U	5.55		35	82	44	36	6	○

Marked : ● Stock available ○ Non-stocked standard

Solid Carbide Drill

Solid Carbide Drill D106 with Internal Coolant - 5xDc

P	M	S	K	H	N	O
••	•	•	••	•	••	•

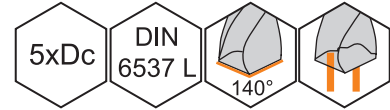
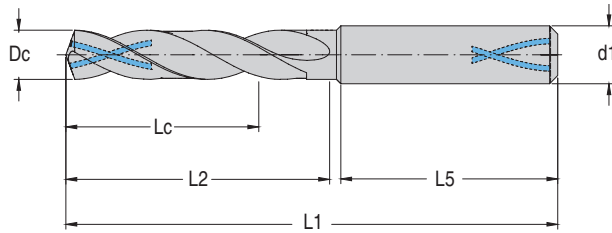

Product code	Dc(m7) mm	Dc inch/No.	Lc mm	L1 mm	L2 mm	L5 mm	d1(h6) mm	stock
D106-05-05556A1 AP30P1U	5.556	7/32"	35	82	44	36	6	○
D106-05-05600A1 AP30P1U	5.6		35	82	44	36	6	○
D106-05-05700A1 AP30P1U	5.7		35	82	44	36	6	○
D106-05-05800A1 AP30P1U	5.8		35	82	44	36	6	●
D106-05-05900A1 AP30P1U	5.9		35	82	44	36	6	●
D106-05-05953A1 AP30P1U	5.953	15/64"	35	82	44	36	6	○
D106-05-06000A1 AP30P1U	6		35	82	44	36	6	●
D106-05-06100A1 AP30P1U	6.1		43	91	53	36	8	○
D106-05-06200A1 AP30P1U	6.2		43	91	53	36	8	○
D106-05-06300A1 AP30P1U	6.3		43	91	53	36	8	○
D106-05-06350A1 AP30P1U	6.35	1/4"	43	91	53	36	8	○
D106-05-06400A1 AP30P1U	6.4		43	91	53	36	8	○
D106-05-06500A1 AP30P1U	6.5		43	91	53	36	8	●
D106-05-06600A1 AP30P1U	6.6		43	91	53	36	8	○
D106-05-06700A1 AP30P1U	6.7		43	91	53	36	8	○
D106-05-06747A1 AP30P1U	6.747	17/64"	43	91	53	36	8	○
D106-05-06800A1 AP30P1U	6.8		43	91	53	36	8	●
D106-05-06900A1 AP30P1U	6.9		43	91	53	36	8	●
D106-05-07000A1 AP30P1U	7		43	91	53	36	8	●
D106-05-07100A1 AP30P1U	7.1		43	91	53	36	8	○
D106-05-07144A1 AP30P1U	7.144	9/32"	43	91	53	36	8	○
D106-05-07200A1 AP30P1U	7.2		43	91	53	36	8	○
D106-05-07300A1 AP30P1U	7.3		43	91	53	36	8	○
D106-05-07400A1 AP30P1U	7.4		43	91	53	36	8	●
D106-05-07500A1 AP30P1U	7.5		43	91	53	36	8	●
D106-05-07541A1 AP30P1U	7.541	19/64"	43	91	53	36	8	○
D106-05-07550A1 AP30P1U	7.55		43	91	53	36	8	○
D106-05-07600A1 AP30P1U	7.6		43	91	53	36	8	○
D106-05-07700A1 AP30P1U	7.7		43	91	53	36	8	○
D106-05-07800A1 AP30P1U	7.8		43	91	53	36	8	●
D106-05-07900A1 AP30P1U	7.9		43	91	53	36	8	●
D106-05-07938A1 AP30P1U	7.938	5/16"	43	91	53	36	8	○
D106-05-08000A1 AP30P1U	8		43	91	53	36	8	●
D106-05-08100A1 AP30P1U	8.1		49	103	61	40	10	○
D106-05-08200A1 AP30P1U	8.2		49	103	61	40	10	○
D106-05-08300A1 AP30P1U	8.3		49	103	61	40	10	○
D106-05-08334A1 AP30P1U	8.334	21/64"	49	103	61	40	10	○
D106-05-08400A1 AP30P1U	8.4		49	103	61	40	10	○
D106-05-08500A1 AP30P1U	8.5		49	103	61	40	10	●
D106-05-08600A1 AP30P1U	8.6		49	103	61	40	10	●
D106-05-08700A1 AP30P1U	8.7		49	103	61	40	10	○
D106-05-08731A1 AP30P1U	8.731	11/32"	49	103	61	40	10	○
D106-05-08800A1 AP30P1U	8.8		49	103	61	40	10	●
D106-05-08900A1 AP30P1U	8.9		49	103	61	40	10	●

Marked : ● Stock available ○ Non-stocked standard

Solid Carbide Drill D106 with Internal Coolant - 5xDc

P	M	S	K	H	N	O
••	•	•	••	•	••	•

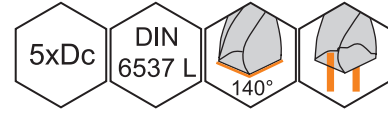
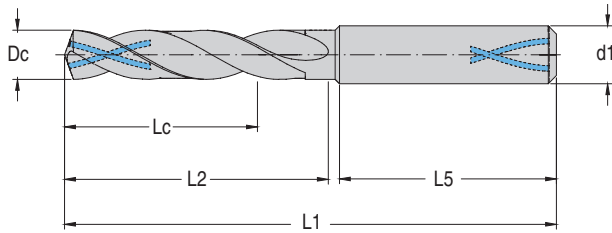

Product code	Dc(m7) mm	Dc inch/No.	Lc mm	L1 mm	L2 mm	L5 mm	d1(h6) mm	stock
D106-05-09000A1 AP30P1U	9		49	103	61	40	10	●
D106-05-09100A1 AP30P1U	9.1		49	103	61	40	10	○
D106-05-09128A1 AP30P1U	9.128	23/64"	49	103	61	40	10	○
D106-05-09200A1 AP30P1U	9.2		49	103	61	40	10	○
D106-05-09300A1 AP30P1U	9.3		49	103	61	40	10	●
D106-05-09400A1 AP30P1U	9.4		49	103	61	40	10	○
D106-05-09500A1 AP30P1U	9.5		49	103	61	40	10	○
D106-05-09525A1 AP30P1U	9.525	3/8"	49	103	61	40	10	○
D106-05-09550A1 AP30P1U	9.55		49	103	61	40	10	○
D106-05-09600A1 AP30P1U	9.6		49	103	61	40	10	○
D106-05-09700A1 AP30P1U	9.7		49	103	61	40	10	○
D106-05-09800A1 AP30P1U	9.8		49	103	61	40	10	●
D106-05-09900A1 AP30P1U	9.9		49	103	61	40	10	●
D106-05-09922A1 AP30P1U	9.922	25/64"	49	103	61	40	10	○
D106-05-10000A1 AP30P1U	10		49	103	61	40	10	●
D106-05-10100A1 AP30P1U	10.1		56	118	71	45	12	●
D106-05-10200A1 AP30P1U	10.2		56	118	71	45	12	●
D106-05-10300A1 AP30P1U	10.3		56	118	71	45	12	●
D106-05-10319A1 AP30P1U	10.319	13/32"	56	118	71	45	12	○
D106-05-10400A1 AP30P1U	10.4		56	118	71	45	12	○
D106-05-10500A1 AP30P1U	10.5		56	118	71	45	12	●
D106-05-10600A1 AP30P1U	10.6		56	118	71	45	12	●
D106-05-10700A1 AP30P1U	10.7		56	118	71	45	12	○
D106-05-10716A1 AP30P1U	10.716	27/64"	56	118	71	45	12	○
D106-05-10800A1 AP30P1U	10.8		56	118	71	45	12	●
D106-05-10900A1 AP30P1U	10.9		56	118	71	45	12	○
D106-05-11000A1 AP30P1U	11		56	118	71	45	12	●
D106-05-11100A1 AP30P1U	11.1		56	118	71	45	12	○
D106-05-11113A1 AP30P1U	11.113	7/16"	56	118	71	45	12	○
D106-05-11200A1 AP30P1U	11.2		56	118	71	45	12	○
D106-05-11300A1 AP30P1U	11.3		56	118	71	45	12	○
D106-05-11400A1 AP30P1U	11.4		56	118	71	45	12	○
D106-05-11500A1 AP30P1U	11.5		56	118	71	45	12	○
D106-05-11509A1 AP30P1U	11.509	29/64"	56	118	71	45	12	○
D106-05-11550A1 AP30P1U	11.55		56	118	71	45	12	○
D106-05-11600A1 AP30P1U	11.6		56	118	71	45	12	○
D106-05-11700A1 AP30P1U	11.7		56	118	71	45	12	○
D106-05-11800A1 AP30P1U	11.8		56	118	71	45	12	●
D106-05-11900A1 AP30P1U	11.9		56	118	71	45	12	○
D106-05-11906A1 AP30P1U	11.906	15/32"	56	118	71	45	12	○
D106-05-12000A1 AP30P1U	12		56	118	71	45	12	●
D106-05-12100A1 AP30P1U	12.1		60	124	77	45	14	○
D106-05-12200A1 AP30P1U	12.2		60	124	77	45	14	○
D106-05-12250A1 AP30P1U	12.25		60	124	77	45	14	○

Marked : ● Stock available ○ Non-stocked standard

Solid Carbide Drill

Solid Carbide Drill D106 with Internal Coolant - 5xDc

P	M	S	K	H	N	O
••	•	•	••	•	••	•

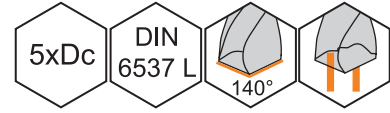
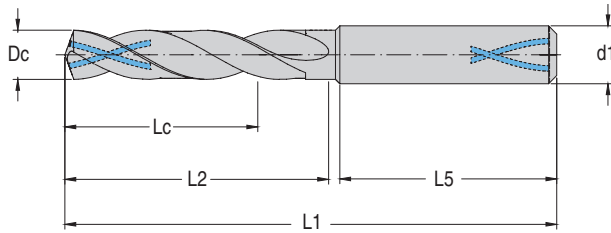





Product code	Dc(m7) mm	Dc inch/No.	Lc mm	L1 mm	L2 mm	L5 mm	d1(h6) mm	stock
D106-05-12300A1 AP30P1U	12.3		60	124	77	45	14	○
D106-05-12303A1 AP30P1U	12.303	31/64"	60	124	77	45	14	○
D106-05-12400A1 AP30P1U	12.4		60	124	77	45	14	○
D106-05-12500A1 AP30P1U	12.5		60	124	77	45	14	●
D106-05-12600A1 AP30P1U	12.6		60	124	77	45	14	○
D106-05-12700A1 AP30P1U	12.7	1/2"	60	124	77	45	14	○
D106-05-12750A1 AP30P1U	12.75		60	124	77	45	14	○
D106-05-12800A1 AP30P1U	12.8		60	124	77	45	14	○
D106-05-12900A1 AP30P1U	12.9		60	124	77	45	14	○
D106-05-13000A1 AP30P1U	13		60	124	77	45	14	●
D106-05-13100A1 AP30P1U	13.1		60	124	77	45	14	○
D106-05-13200A1 AP30P1U	13.2		60	124	77	45	14	●
D106-05-13300A1 AP30P1U	13.3		60	124	77	45	14	○
D106-05-13400A1 AP30P1U	13.4		60	124	77	45	14	○
D106-05-13494A1 AP30P1U	13.494	17/32"	60	124	77	45	14	○
D106-05-13500A1 AP30P1U	13.5		60	124	77	45	14	○
D106-05-13600A1 AP30P1U	13.6		60	124	77	45	14	○
D106-05-13700A1 AP30P1U	13.7		60	124	77	45	14	●
D106-05-13800A1 AP30P1U	13.8		60	124	77	45	14	○
D106-05-13900A1 AP30P1U	13.9		60	124	77	45	14	○
D106-05-14000A1 AP30P1U	14		60	124	77	45	14	●
D106-05-14100A1 AP30P1U	14.1		63	133	83	48	16	●
D106-05-14200A1 AP30P1U	14.2		63	133	83	48	16	●
D106-05-14288A1 AP30P1U	14.288	9/16"	63	133	83	48	16	○
D106-05-14300A1 AP30P1U	14.3		63	133	83	48	16	○
D106-05-14400A1 AP30P1U	14.4		63	133	83	48	16	○
D106-05-14500A1 AP30P1U	14.5		63	133	83	48	16	●
D106-05-14600A1 AP30P1U	14.6		63	133	83	48	16	●
D106-05-14700A1 AP30P1U	14.7		63	133	83	48	16	●
D106-05-14750A1 AP30P1U	14.75		63	133	83	48	16	○
D106-05-14800A1 AP30P1U	14.8		63	133	83	48	16	○
D106-05-15000A1 AP30P1U	15		63	133	83	48	16	●
D106-05-15100A1 AP30P1U	15.1		63	133	83	48	16	○
D106-05-15200A1 AP30P1U	15.2		63	133	83	48	16	○
D106-05-15300A1 AP30P1U	15.3		63	133	83	48	16	○
D106-05-15500A1 AP30P1U	15.5		63	133	83	48	16	●
D106-05-15600A1 AP30P1U	15.6		63	133	83	48	16	○
D106-05-15700A1 AP30P1U	15.7		63	133	83	48	16	●
D106-05-15800A1 AP30P1U	15.8		63	133	83	48	16	●
D106-05-15875A1 AP30P1U	15.875	5/8"	63	133	83	48	16	○
D106-05-15900A1 AP30P1U	15.9		63	133	83	48	16	○
D106-05-16000A1 AP30P1U	16		63	133	83	48	16	●

Marked : ● Stock available ○ Non-stocked standard

Cutting Data for D106 Solid Carbide Drill Family

The specified cutting data are average recommended values. For special applications, adjustment is recommended.

Vc=Cutting speed (m/min) Feed code = feed reference table see page 306				Drilling depth		3xDc				5xDc					
															
				Product family				D106		D106		D106		D106	
				Dia. Range(mm)				3.00-16.00		3.00-16.00		3.00-16.00		3.00-16.00	
Workpiece material				Coolant		External coolant		Internal coolant		External coolant		Internal coolant			
				Brinell hardness (HB)	Tensile strength Rm (N/mm ²)	Vc	Feed code	Vc	Feed code	Vc	Feed code	Vc	Feed code		
P	Unalloyed steel	C≤0.25%	Annealed	125	428	80-100	F	90-115	F	80-100	F	90-115	F		
		0.25 < C≤0.55%	Annealed	190	639	70-90	E	80-100	E	70-90	E	80-100	E		
		0.25 < C≤0.55%	Heat-treated	210	708	70-90	E	80-100	E	70-90	E	80-100	E		
		C > 0.55%	Annealed	190	639	70-90	E	80-100	E	70-90	E	80-100	E		
		C > 0.55%	Heat-treated	300	1013	50-70	D	50-70	D	50-70	D	50-70	D		
		Free cutting steel (short-chipping)	Annealed	220	745	80-100	F	90-115	F	80-100	F	90-115	F		
	Low-alloyed steel	Annealed		175	591	70-100	E	80-110	E	70-100	E	80-110	E		
		Heat-treated		300	1013	50-70	D	60-70	D	50-70	D	60-70	D		
		Heat-treated		380	1282	35-45	C	40-50	C	35-45	C	40-50	C		
		Heat-treated		430	1477	30-40	B	30-40	B	30-40	B	30-40	B		
	High-alloyed steel and high-alloyed tool steel	Annealed		200	675	55-65	D	60-80	D	55-65	D	60-80	D		
		Hardened and tempered		300	1013	40-50	C	40-60	C	40-50	C	40-60	C		
		Hardened and tempered		400	1361	30-40	C	45-50	C	30-40	C	45-50	C		
	Stainless steel	Ferritic/martensitic, annealed		200	675	50-70	D	60-80	D	50-70	D	60-80	D		
Martensitic, heat-treated		330	1114	40-50	C	40-50	C	40-50	C	40-50	C				
M	Stainless steel	Austenitic, quench hardened		200	675			40-50	C			40-50	C		
		Austenitic, precipitation hardened (PH)		300	1013	35-45	C	40-50	C	35-45	C	40-50	C		
		Austenitic/ferritic, duplex		230	778			25-35	B			25-35	B		
K	Malleable cast iron	Ferritic		200	400	70-90	G	70-90	G	70-90	G	70-90	G		
		Pearlitic		260	700	60-80	G	60-80	G	60-80	G	60-80	G		
	Grey cast iron	Low tensile strength		180	200	80-100	H	80-110	H	80-100	H	80-110	H		
		High tensile strength/austenitic		245	350	70-90	G	70-90	G	70-90	G	70-90	G		
	Cast iron with spheroidal graphite	Ferritic		155	400	80-100	G	80-110	H	80-100	G	80-110	H		
		Pearlitic		265	700	60-80	F	60-80	F	60-80	F	60-80	F		
GGV (CGI)				230	400	60-80	F	60-80	F	60-80	F	60-80	F		
N	Wrought aluminium alloys	non-aging		30	-	200-300	G	300-400	G	200-300	G	300-400	G		
		aged		100	340	200-300	G	300-400	G	200-300	G	300-400	G		
	Cast aluminium alloys	≤ 12% Si, non-aging		75	260	160-220	H	180-240	H	160-220	H	180-240	H		
		≤ 12% Si, aged		90	310	160-200	H	180-200	H	160-200	H	180-200	H		
		> 12% Si, non-aging		130	450	130-160	G	140-180	G	130-160	G	140-180	G		
	Magnesium alloys				70	250									
	Copper and copper alloys (bronze/brass)	Unalloyed, electrolytic copper		100	340	120-160	C	140-170	D	120-160	C	140-170	D		
Brass, bronze, red brass		90	310	110-140	E	120-140	E	110-140	E	120-140	E				
Cu alloys, short-chip		110	380	120-150	F	140-180	F	120-150	F	140-180	F				
High tensile, Ampco alloy		300	1010	45-60	B	45-60	B	45-60	B	45-60	B				
S	Heat-resistant alloys	Fe-based	Annealed	200	680			30-40	B			30-40	B		
			Hardened	280	940			20-25	A			20-25	A		
		Ni or Co based	Annealed	250	840			20-30	B			20-30	B		
			Hardened	350	1180			10-15	A			10-15	A		
	Titanium alloys	Cast		320	1080			15-25	A			15-25	A		
		Pure titanium		200	680	30-40	B	40-50	C	30-40	B	40-50	C		
α and β alloys, hardened		375	1260	20-30	A	25-35	B	20-30	A	25-35	B				
β alloys		410	1400			10-15	A			10-15	A				
Tungsten alloys		1177		300	1010										
Molybdenum alloys		1262		300	1010										
H	Hardened steel	Hardened and tempered		50HRC	-	20-35	A	20-35	A	20-35	A	20-35	A		
		Hardened and tempered		55HRC	-										
		Hardened and tempered		60HRC	-										
	Hardened cast iron		Hardened and tempered		50HRC	-									

Feed Reference Table

		Feed rate f (mm/rev)							
Dia. mm		A	B	C	D	E	F	G	H
	3.0	0.03	0.04	0.05	0.06	0.08	0.10	0.12	0.14
	4.0	0.04	0.05	0.06	0.08	0.10	0.12	0.14	0.16
	5.0	0.05	0.06	0.07	0.09	0.10	0.12	0.16	0.18
	6.0	0.05	0.07	0.08	0.10	0.12	0.15	0.18	0.20
	8.0	0.06	0.08	0.10	0.12	0.15	0.18	0.20	0.23
	10.0	0.08	0.10	0.12	0.14	0.18	0.20	0.24	0.28
	12.0	0.10	0.12	0.14	0.18	0.20	0.24	0.28	0.32
	14.0	0.10	0.14	0.18	0.20	0.24	0.28	0.32	0.34
	16.0	0.12	0.15	0.18	0.20	0.25	0.30	0.34	0.36
20.0	0.15	0.16	0.20	0.25	0.30	0.34	0.37	0.40	

Thread Pilot Hole Diameters-Tapping

M			
Metric coarse pitch thread DIN 13 and DIN ISO 965-1			
D	D1		
Diameter	Min (mm)	Max(mm) 5H/6H	Diameter
M4	3.242	3.422	3.30
M4.5	3.688	3.878	3.70
M5	4.134	4.334	4.20
M6	4.917	5.153	5.00
M7	5.917	6.153	6.00
M8	6.647	6.912	6.80
M9	7.647	7.912	7.80
M10	8.376	8.676	8.50
M11	9.376	9.676	9.50
M12	10.106	10.441	10.20
M14	11.835	12.210	12.00
M16	13.835	14.210	14.00
M18	15.294	15.744	15.50
M20	17.294	17.744	17.50
M22	19.294	19.744	19.50

UNC			
Coarse thread ASME B1.1 standard			
D	D1		
Diameter P Gg/1"	Min (mm) 2B/3B	Max(mm) 2B	Diameter
8-32 UNC	3.302	3.531	3.50
10-24 UNC	3.683	3.962	3.90
12-24 UNC	4.343	4.597	4.50
1/4-20 UNC	4.976	5.268	5.10
5/16-18 UNC	6.411	6.734	6.60
3/8-16 UNC	7.805	8.164	8.00
7/16-14 UNC	9.149	9.550	9.40
1/2-13 UNC	10.584	11.013	10.28
9/16-12 UNC	11.996	12.456	12.20
5/8-11 UNC	13.376	13.868	13.50
3/4-10 UNC	16.299	16.833	16.50
7/8-9 UNC	19.169	19.748	19.50

UNF			
Fine thread ASME B1.1 standard			
D	D1		
Diameter P Gg/1"	Min (mm) 2B/3B	Max(mm)2B	Diameter
8-36 UNC	3.404	3.607	3.50
10-32 UNC	3.962	4.166	4.10
12-28 UNC	4.496	4.724	4.60
1/4-28 UNC	5.367	5.580	5.50
5/16-24 UNC	6.792	7.038	6.90
3/8-24 UNC	8.379	8.626	8.50
7/16-20 UNC	9.738	10.030	9.90
1/2-20 UNC	11.326	11.618	11.50
9/16-18 UNC	12.761	13.084	12.90
5/8-18 UNC	14.348	14.671	14.50
3/4-16 UNC	17.330	17.689	17.50

MF		
Metric fine pitch thread DIN 13 and DIN ISO 965-1		
D	D1	
Diameter*P	Max mm 5H/6H	Diameter
M3.5x0.35	3.221	3.15
M4x0.35	3.721	3.65
M4x0.5	3.599	3.50
M4.5x0.5	4.099	4.00
M5x0.35	4.721	4.65
M5x0.5	4.599	4.50
M5x0.75	4.378	4.20
M5x0.5	5.599	5.50
M6x0.75	5.378	5.25
M7x0.5	6.599	6.50
M7x0.75	6.378	6.25
M8x0.5	7.599	7.50
M8x0.75	7.378	7.25
M8x1	7.153	7.00
M9x0.75	8.378	8.25
M9x1	8.153	8.00
M10x0.5	9.599	9.50
M10x0.75	9.378	9.25
M10x1	9.153	9.00
M10x1.25	8.912	8.75
M11x1	10.153	10.00
M12x0.5	11.599	11.50
M12x1	11.153	11.00
M12x1.25	10.912	10.75
M12x1.5	10.676	10.50
M13x1	12.153	12.00
M14x0.75	13.378	13.20
M14x1	13.153	13.00
M14x1.25	12.912	12.75
M14x1.5	12.676	12.50
M15x1	14.153	14.00
M15x1.5	13.676	13.50
M16x0.75	15.378	15.20
M16x1	15.153	15.00
M16x1.25	14.912	14.80
M16x1.5	14.676	14.50
M17x1	16.153	16.00
M18x1	17.153	17.00
M18x1.5	16.676	16.50
M18x2	16.21	16.00
M20x1	19.153	19.00
M20x1.5	18.676	18.50
M20x2	18.21	18.00

Thread Pilot Hole Diameters- Forming

M	Metric coarse pitch thread DIN 13 and DIN ISO 965-1
D	
Diameter	Diameter
M3.5	3.25
M4	3.70
M5	4.65
M6	5.55
M8	7.40
M10	9.30
M12	11.20
M14	13.10
M16	15.10
M18	16.90
M20	18.90

MF	Metric fine pitch thread DIN 13 and DIN ISO 965-1
D	
Diameter	Diameter
M4x0.5	3.80
M5x0.5	4.80
M6-0.5	5.80
M6-0.75	5.65
M7-0.75	6.65
M8-0.75	7.65
M8-1	7.55
M10-0.75	9.65
M10-1	9.55
M10-1.25	9.40
M12-1	11.55
M12-1.25	11.40
M12-1.5	11.30
M14-1	13.55
M14-1.5	13.30
M16-1	15.55
M16-1.5	15.30
M18-1	17.55
M18-1.5	17.30
M20-1.5	19.30
M20-2	19.10
M22-1.5	21.30

UNC	Coarse thread ASME B1.1 standard
D	
Diameter	Diameter
6-32 UNC	3.15
8-32 UNC	3.80
10-24 UNC	4.30
12-24 UNC	5.00
1/4-20 UNC	5.75
5/16-18 UNC	7.25
3/8-16 UNC	8.75
7/16-14 UNC	10.30
1/2-13 UNC	11.80
9/16-12 UNC	13.30
5/8-11 UNC	14.80
3/4-10 UNC	17.90

UNF	Fine thread ASME B1.1 standard
D	
Diameter	Diameter
6-40 UNC	3.20
8-36 UNC	3.85
10-32 UNC	4.45
12-28 UNC	5.05
1/4-28 UNC	5.90
5/16-24 UNC	7.45
3/8-24 UNC	9.00
7/16-20 UNC	10.50
1/2-20 UNC	12.10
9/16-18 UNC	13.70
5/8-18 UNC	15.25
3/4-16 UNC	18.40

ACHTTECK

www.achtecktool.com



CUTTING TOOL CATALOGUE

Chuck denomination rule	312
HSK series	313
Side lock chuck	313
Milling cutter arbor	315
BT series	317
Side lock chuck	317
Milling cutter arbor	319
Extension	322
Accessories	323
HSK coolant tube	323

Chuck Denomination Rule

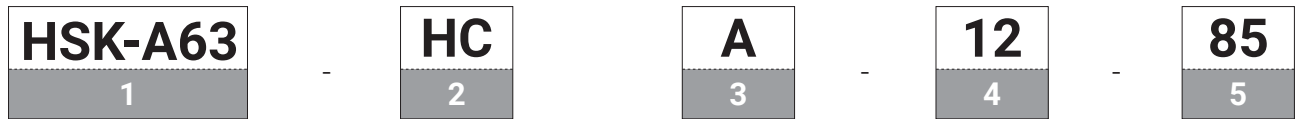

1-Type of spindle
HSK-A63 HSK-A100 BT30 BT40 BT50

2-Type of clamping	
Code	Name
HC	Hydraulic Chuck
SF	Shrink Fit Chuck
ER	ER Collet Chuck
SL	Side Lock Chuck
PC	Power Mill Chuck
FM	Face Milling Cutter Arbor

3-Distinguishing code	
Shrink Fit Chuck/Hydraulic Chuck/ Power Mill Chuck	Without-----Standard L-----Mini H-----Heavy Duty Design
Side Lock Chuck	B-----Weldon Type E-----Whistle Notch Type
Face Milling Cutter Arbor	A-----Common Clamping Screw B-----Cross Clamping Screw C-----Periphery Clamping Screw D-----For Slot Milling Cutter
ER Collet Chuck	Without-----General Type V-----Tapping Type H-----High Speed Type

4- Clamping diameter
dm=12

5-Length of chuck
L=85

Side Lock Chuck, Weldon Type

DIN69893

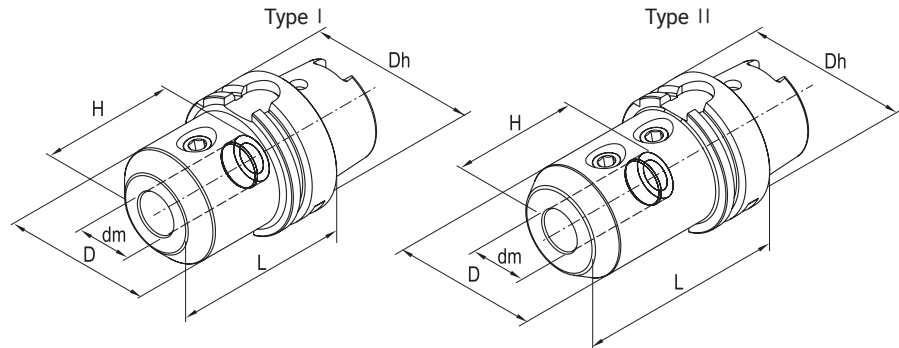

Product code	Stock		Dimension (mm)					Model
			Dh	dm	D	L	H	
DIN69893								
HSK-A63-SLB16-80	●	HSK-A63	63	16	48	80	52	I
HSK-A63-SLB20-80	●	HSK-A63	63	20	52	80	54	I
HSK-A63-SLB25-110	●	HSK-A63	63	25	65	110	66	II
HSK-A63-SLB32-110	●	HSK-A63	63	32	72	110	70	II
HSK-A100-SLB16-100	○	HSK-A100	100	16	48	100	52	I
HSK-A100-SLB20-100	●	HSK-A100	100	20	52	100	54	I
HSK-A100-SLB25-100	●	HSK-A100	100	25	65	100	66	II
HSK-A100-SLB32-100	●	HSK-A100	100	32	72	100	66	II
HSK-A100-SLB40-100	●	HSK-A100	100	40	80	100	80	II
HSK-A100-SLB40-160	○	HSK-A100	100	40	80	160	80	II

● Stock available ○ Produced by order

HSK series

Side Lock Chuck, Whistle Notch Type

DIN69893

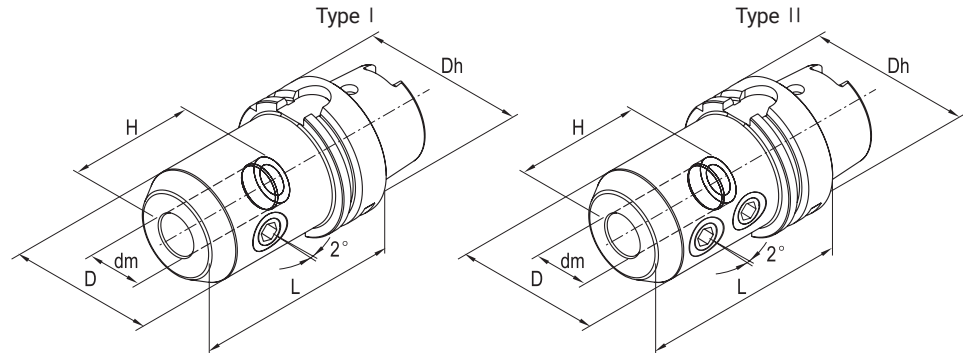

Product code	Stock		Dimension (mm)					Model
			Dh	dm	D	L	H	
DIN69893								
HSK-A63-SLE16-100	○	HSK-A63	63	16	48	100	52	I
HSK-A63-SLE20-100	○	HSK-A63	63	20	52	100	54	I
HSK-A63-SLE25-110	○	HSK-A63	63	25	65	110	59	II
HSK-A63-SLE32-110	○	HSK-A63	63	32	72	110	63	II
HSK-A100-SLE16-100	○	HSK-A100	100	16	48	100	52	I
HSK-A100-SLE20-110	○	HSK-A100	100	20	52	110	54	I
HSK-A100-SLE25-120	○	HSK-A100	100	25	65	120	59	II
HSK-A100-SLE32-120	○	HSK-A100	100	32	72	120	63	II

● Stock available ○ Produced by order

Face Milling Cutter Arbor

DIN69893

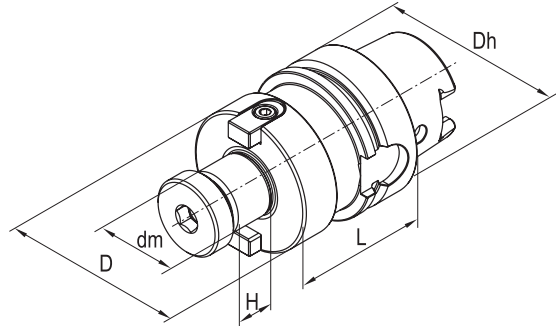

Product code	Stock		Dimension (mm)				
			Dh	dm	D	L	H
DIN69893							
HSK-A63-FMA16-60	●	HSK-A63	63	16	35	60	17
-100	○	HSK-A63	63	16	35	100	17
HSK-A63-FMA22-60	●	HSK-A63	63	22	48	60	19
-100	○	HSK-A63	63	22	48	100	19
HSK-A63-FMA27-60	●	HSK-A63	63	27	60	60	21
-100	○	HSK-A63	63	27	60	100	21
HSK-A63-FMB32-60	●	HSK-A63	63	32	78	60	24
-100	○	HSK-A63	63	32	78	100	24
HSK-A63-FMB40-60	●	HSK-A63	63	40	89	60	27
HSK-A100-FMA22-60	●	HSK-A100	100	22	48	60	19
-100	○	HSK-A100	100	22	48	100	19
HSK-A100-FMA27-60	●	HSK-A100	100	27	60	60	21
-100	○	HSK-A100	100	27	60	100	21
HSK-A100-FMB32-60	●	HSK-A100	100	32	78	60	24
-100	○	HSK-A100	100	32	78	100	24
HSK-A100-FMB40-60	●	HSK-A100	100	40	89	60	27
-100	○	HSK-A100	100	40	89	100	27

● Stock available ○ Produced by order

HSK series

Face Milling Cutter Arbor

DIN69893

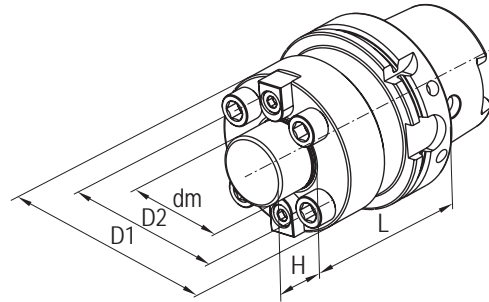

Product code	Stock		Dimension (mm)				
DIN69893			dm	D1	D2	L	H
HSK-A100-FMC40-60	○	HSK-A100	40	108	66.7	60	27
HSK-A100-FMC60-75	○	HSK-A100	60	129	101.6	75	38

● Stock available ○ Produced by order

Side Lock Chuck, Weldon Type

JIS B6339

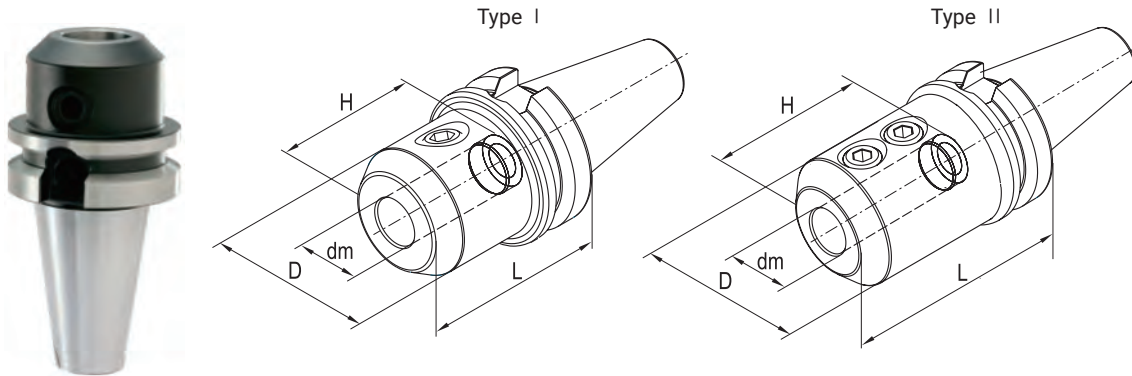

Product code	Stock		Dimension (mm)				Model
			dm	D	L	H	
JIS B6339-AD							
BT40-SLB16-90	●	40	16	48	90	52	I
BT40-SLB20-100	●	40	20	52	100	54	I
BT40-SLB25-100	●	40	25	65	100	66	II
BT40-SLB32-100	●	40	32	72	100	70	II
BT50-SLB16-80	●	50	16	48	80	52	I
BT50-SLB20-100	●	50	20	52	100	54	I
BT50-SLB25-100	●	50	25	65	100	66	II
BT50-SLB32-100	●	50	32	74	100	70	II
BT50-SLB40-115	●	50	40	80	115	80	II

● Stock available ○ Produced by order

BT series

Side Lock Chuck, Whistle Notch Type

JIS B6339

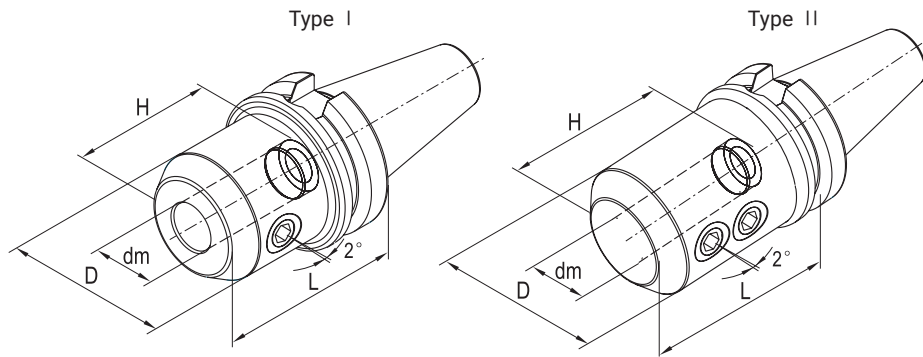

Product code	Stock		Dimension (mm)				Model
			dm	D	L	H	
JIS B6339-AD							
BT40-SLE16-63	○	40	16	48	63	52	I
BT40-SLE20-63	●	40	20	52	63	54	I
BT40-SLE25-100	●	40	25	65	100	59	II
BT40-SLE32-100	●	40	32	72	100	63	II
BT50-SLE16-80	○	50	16	48	80	52	I
BT50-SLE20-80	●	50	20	52	80	54	I
BT50-SLE25-100	●	50	25	65	100	59	II
BT50-SLE32-100	●	50	32	72	100	63	II

● Stock available ○ Produced by order

Face Milling Cutter Arbor

JIS B6339

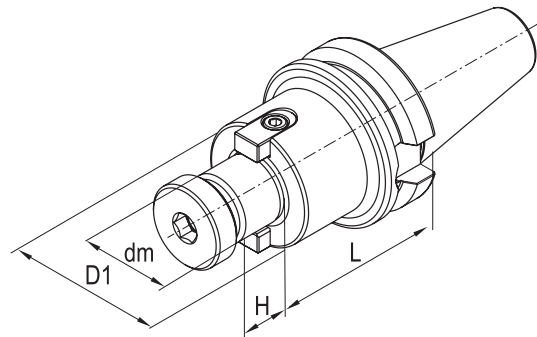

Product code	Stock		Dimension (mm)			
			dm	D1	L	H
JIS B6339-A						
BT40-FMA16-60	●	40	16	35	60	17
-100	○	40	16	35	100	17
-150	○	40	16	35	150	17
BT40-FMA22-60	●	40	22	48	60	19
-100	●	40	22	48	100	19
-150	●	40	22	48	150	19
BT40-FMA27-60	●	40	27	60	60	21
-100	○	40	27	60	100	21
-150	○	40	27	60	150	21
BT40-FMB32-60	●	40	32	78	60	24
BT40-FMB40-60	●	40	40	89	60	27

● Stock available ○ Produced by order

BT series

Face Milling Cutter Arbor

JIS B6339

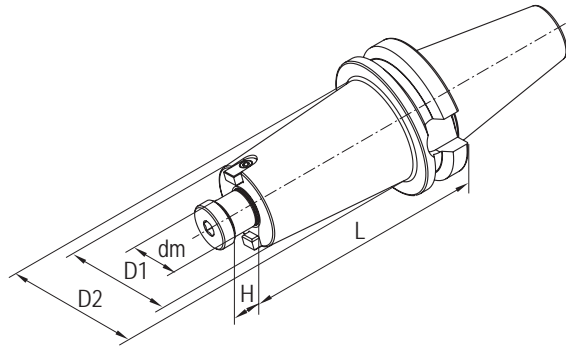

Product code	Stock		Dimension (mm)				
			dm	D1	D2	L	H
JIS B6339-A							
BT50-FMA22-60	●	50	22	48	-	60	19
-100	●	50	22	48	-	100	19
-150	●	50	22	48	60	150	19
-200	●	50	22	48	60	200	19
-250	○	50	22	48	60	250	19
BT50-FMA27-60	●	50	27	60	-	60	21
-100	●	50	27	60	-	100	21
-150	●	50	27	60	75	150	21
-200	○	50	27	60	75	200	21
-250	○	50	27	60	75	250	21
BT50-FMB32-60	●	50	32	78	-	60	24
-100	○	50	32	78	-	100	24
-150	○	50	32	78	-	150	24
BT50-FMB40-60	●	50	40	89	-	60	27
-100	○	50	40	89	-	100	27

● Stock available ○ Produced by order

Face Milling Cutter Arbor

JIS B6339

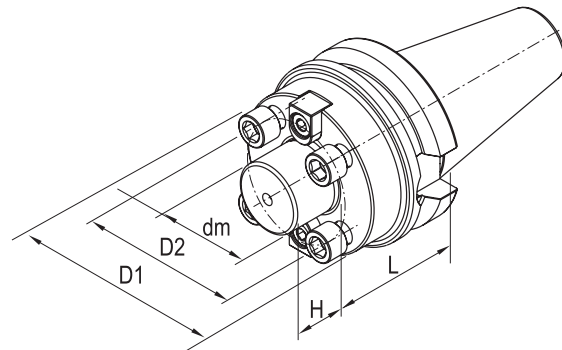

Product code	Stock		Dimension (mm)				
			dm	D1	D2	L	H
JIS B6339-A							
BT50-FMC40-60	●	50	40	108	66.7	60	27
BT50-FMC60-75	●	50	40	129	101.6	75	38

● Stock available ○ Produced by order

Head Taper Shank

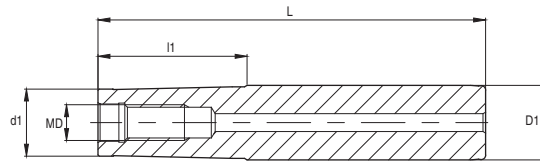

Product code	Dimension (mm)					Coolant	Material
	MD	D1	d1	L	l1		
AMS-M08-020-080-16T	M8	16	14.5	80	20		steel
AMS-M08-040-100-16T	M8	16	14.5	100	40		steel
AMC-M08-080-150-16T	M8	16	14.5	150	80		carbide
AMC-M08-150-200-16T	M8	16	14.5	200	150		carbide
AMS-M10-030-100-20T	M10	20	18	100	30		steel
AMS-M10-050-120-20T	M10	20	18	120	50		steel
AMC-M10-090-150-20T	M10	20	18	150	90		carbide
AMC-M10-140-200-20T	M10	20	18	200	140		carbide
AMS-M12-030-110-25T	M12	25	22.5	110	30		steel
AMS-M12-050-130-25T	M12	25	22.5	130	50		steel
AMC-M12-120-180-25T	M12	25	22.5	180	120		carbide
AMC-M12-140-250-25T	M12	25	22.5	250	140		carbide
AMS-M16-035-125-32T	M16	32	28.5	125	35		steel
AMS-M16-055-145-32T	M16	32	28.5	145	55		steel
AMC-M16-120-200-32T	M16	32	28.5	200	120		carbide
AMC-M16-180-260-32T	M16	32	28.5	260	180		carbide

Straight Shank

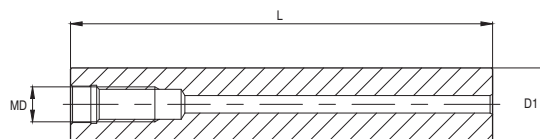

Product code	Dimension (mm)			Coolant	Material
	MD	D1	L		
AMC-M08-105-16S	M8	16	105		carbide
AMC-M08-160-16S	M8	16	160		carbide
AMC-M10-130-20S	M10	20	130		carbide
AMC-M10-250-20S	M10	20	250		carbide
AMC-M12-145-25S	M12	25	145		carbide
AMC-M12-285-25S	M12	25	285		carbide
AMC-M16-157-32S	M16	32	157		carbide
AMC-M16-287-32S	M16	32	287		carbide

HSK Coolant Tube

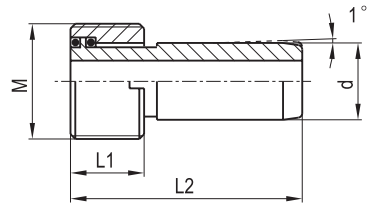
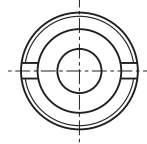

Product code	Stock		Dimension (mm)			
			M	d	L1	L2
CT-HSK63	●	HSK-63	M18 × 1	12	11.5	36.6
CT-HSK100	●	HSK-100	M24 × 1.5	16	15.5	44.2

● Stock available ○ Produced by order

ACHTTECK

www.achtecktool.com



CUTTING TOOL CATALOGUE

Technical guide	324
Turning information	326
Milling information	331
Drilling information	337
General technical information	338
Hardness conversion table	338
Material conversion table	340
Index	346

Grade Conversion Table

Turning

ISO classification	Material classification	ACHTECK	COROMANT	ISCAR	KENAMETAL	KORLOY	KYOCERA	MITSUBISHI	SECO	SUMITOMO	TAEGUTEK	TUNGALOY	WALTER	ZCC
P	P10	AC150P	GC4315 GC4215	IC8150	KCP10 KC9110	NC3010 NC3015	CA515 CA5515	MC6015 UE6110	TP1500 TP1501	AC810P AC700G	TT8115	T9115 T9015	WPP10S WPP10	YBC152 YBC151
	P20	AC250P	GC4325 GC4225	IC8250	KCP25 KC9215	NC3220 NC3120	CA525 CA5525	MC6025 UE6020	TP2500 TP2501	AC8025P AC820P	TT8125	T9125 T9025	WPP20S WPP20	YBC251 YBC252
	P30	AC350P	GC4335 GC4235	IC8350	KCP30 KCP40 KC9040	NC3030 NC500H	CA5535	MC6035 UE6035	TP3500	AC830P	TT8135 TT8020*	T9135 T9035	WPP30S WPP30	YBC351 YBC352
M	M10	AP100S*	GC2015 GC1105*	IC907* IC807*	KCM15 KC5510* KCU10*	PC8110*	CA6515 PR1305* PR1310* PR1215*	MC7015 US7020 VP10RT* MP9005*	TS2000* TH1000* CP200*	AC610M AC6020M AC510U*	TT9215 TT5080*	AH110* AH905* AH8005*	WSM10* WSM10S*	YBM151 YBG102* YBG105*
	M20	AP301M*	GC2025 GC1115* GC15*	IC908* IC887*	KCM25 KC5525* KCU25*	NC9025 PC5300*	CA6525 PR930* PR1025* RP1225* PR1325*	MC7025 VP15TF* MP9015*	TM2000 CP500*	AC620M AC6030M AC520U*	TT9225 TT9080*	T6120 T6020 AH120* AH630* AH8015*	WSM20* WSM20S* WMP20S	YBM251 YBG202* YBG212* YBG205*
K	K10	AC100K	GC3205 GC3005	IC5005	KCK05	NC6205	CA4505 CA4010	MC5005 UC5105	TK1001 TK1000	AC405K AC410K	TT7005	T505	WKK10S WAK10	YBD052
	K20	AC150K ACK15A	GC3210 GC3215	IC5010	KCK15 KC9315	NC6110	CA4515 CA415	MC5015 UC5115	TK2001 TK2000	AC415K AC700G	TT7310 TT7015	T5115 T515	WKK20S WAK20	YBD152C YBD152
S	S10	AP100S*	GCS05F GC1105* GC1115*	IC807* IC907*	KCU10* KC5510* KC5010	PC8110*	PR1305* PR1310*	VP10RT* MP9005*	TH1000* TH1500* TS2000*	AC510U*	TT5080*	AH110* AH905* AH8005*	WSM10*	YBG102* YBG105*
	S20	AP301M*	GC15* GC1115*	IC808* IC908*	KCU20* KC5525* KC5025*	PC5300*	PR1025* PR1225* PR1325*	VP15TF* MP9015*	CP500*	AC520U*	TT9080*	AH120* AH8015*	WSM20*	YBG212* YBG202* YBG205*
N	N10	AW100K	H10	IC20	K68 K313	H01	KW10	HTI10	KX	H1	K10	TH10	WK1	YD101

**PVD coating grades

Turning Chip Breaker Conversion Table

Negative turning insert

ISO classification	Application	ACHTECK	COROMANT	ISCAR	DURACARB	KENNAMETAL	KORLOY	KYOCERA	MITSUBISHI	SECO	SUMITOMO	TAEGUTEK	TUNGALOY	VALENITE	WALTER	ZCC	
P	Finishing	PB1	QF	SF, F3P	41	FF, FS FP, LF, FN	HU, VL VG, VF, VQ	DP, GP, PP, VF XF, XP, HQ	FH LP, SH, FY	FF1, FF2 MF2	FA, FL SU, SE	FA, FS, FX FG, FM	TF, 01, ZF NS, 11, TS, AS, TSF	F2	FP5 NF4	SF NF, DF	
		Semi-finishing	PB3	PF, XF		43		VB, VC, HC	CQ, PQ, CJ	SA		LU	FC, FT			NS6	NM
	Medium machining	PL5	K			52	MN	HC	GS	ES	UX	GX, HM	VF, DNUX, FS	S			
			QM, 23, LC, SM, -NGP, 23, SR, SMR	PP, TF		42	MS, MP, UP, P, -NGP, RP	HA, VP3, VM	XQ, XS, A3, AH, MS, MU	MJ, SY, MS, GJ	MF4, MF5, M5, MR3, MR4	UP, GX, AG, EG, EX, UP, MU	ML, MP	P, HMM, SA	M2	MP3	NMS, NMT, NRS, NRT
		PC3	PM, XM, QM	M3P, VL	45	P	VM, HS, GS	PG, PS	MP, MV, MA	MF3, MF5, M3	GE, GU	PC	TM	M2	MP5, NM4	PM	
		PD3	HM, XMR	GN	46	MP, RP, RM	HM, GM	HS, CS			UX, UG	MT		M3	NM6, NM9	DM	
	PC4		MG-	53	UN	B25	MG-C	MG-	M4, MR4	UZ	MG-	33, 37, 38, DM, MG-		MG-	MG-		
	Roughing machining	PD5	PR	NR, R3P		RN	HR, GR	PT, GT, PH, HT	MH, GH, RP	M5, MR7, M6	ME, MU, MX	RT	TH	R3	NR4, RP5	DR	
	Heavy machining	PD8	PR				RM		PX				RX			NRF	
			QR, MR	R3P, NM			MR, RP	GH	HX	HZ	R6, RR9, R4, R5, 37, RR6	MP, HG, HP	RH	TRS, 57	R6	NR6	
		PC9	HR, 31			RH	VT		HCS, HX, HBS	R8, 56, 57, R7	HF, HU	HT, HD	65, TU		NRR	ER, HDR	
	PD9						VH		HV, HDS, HXD		HW	HY, HZ					
M	Finishing	MB2	MF	SF, F3M	41	FP	HA, VP2	MQ, GU	FS, LM	MF1	SU	EA, SF	SF	F5	NF4	EF	
	Medium machining	MC3	MM	M3M	42	MP, UP	GS, HS	MS, MU	MS, GM, MA	MF4	EX, UP, GU	EM	SS, S		NM4	EM	
	Roughing machining	MC4	MR	R3M	45	RP	VM	HU	RM	MR6, MF5	MU, HM	ET	SM	M5	NR4, NRS	ER	
K	Medium machining	PC4		MG-	53	RP		C	MG-, GK	M5		MG-	MG-		NM5, RK5	MG-	
	Roughing machining	KC4, KD5	KR			UN	GR	ZS, GC	GX, RK	MR7	GZ	KT, RT	CH		RK7	DR	
S	Finishing	MB2	SF	SF		FS	VP1	MQ	FJ	MF1	EF	EA, SF		F5	NF4	NF	
	Medium machining	SC3	SGF, SM, -NGP, 23, SR, SMR	PP, TF	42	MS, UP, P, -NGP, RP	VP2, VP3, VM	MS, MU	MJ, MS, GJ	M1, MF4, MF5, M5, MR3, MR4	SU, EG, EX, UP, MU	ML, MP, SU, MK	HMM, SA	M2	NFT, NMS, NMT, NRS, NRT	NM	
	Roughing machining	MC4	MR	R3M	45	RP	VM	HU	RM	MR6, MF5	MU, HM	ET	SM	M5	NR4, NRS	ER	

Turning Chip Breaker Conversion Table

Positive turning insert

ISO classification	Application	ACHTECK	COROMANT	DURACARB	ISCAR	KENNAMETAL	KORLOY	KYOCERA	mitsubishi	SECO	SUMITOMO	TAEGUTEK	TUNGALOY	VALENITE	WALTER	ZCC
P M K	Finishing		PF, UF		38, PF	UF, 11, GM	VL, VF, HFP	XP GK, GP, DP VF	FV	FF1	LU FP	FA FX	01, PF, PSF		PF4, PF5	SF HF
		PB1 PC2						CF, GF GQ CK	SMG		FC	SA	JS			
	Semi-finishing		UM XF	51	SM 16, GT-	FP LF	VF HMP, C05	XQ GX	SQ, SV	F1	FK SU SC, SK	FG		PM3 PM4	PS5	HM
		PC2	PM	41		MP		HQ				PC FM	PSS PS			EF EM
Medium machining	KC2	XM PR, UR XR	52	14, 17 19, MT-	MF	C25	MT-	MQ, MV MT-G	F2	SF, MU	MT	PM	PM5	PM5 E47, MT-	HR	
N	Semi-finishing	NC2	AL	AU	AF, AS	HP	AK, AR	AH	AZ	AL	AW, AG	FL	AL	IL	PM2	LH

Turning Machining Formula

● Cutting speed

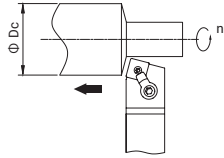

$$V_c = \frac{\pi * D_c * n}{1000} \text{ (m/min)}$$

V_c:Cutting speed(m/min) π: ≈3.14
D_c:Workpiece diameter(mm) n:Spindle speed(rev/min)

● Feed speed

$$V_f = f * n \text{ (mm/min)}$$

V_f:Cutting speed(mm/min) f:Feed rate(mm/rev)
n:Spindle speed(rev/min)

● Chip thickness

$$h = f * \sin \alpha \text{ (mm)}$$

h:Chip thickness(mm) f:Feed rate(mm/rev)

● Chip width

$$b = \frac{a_p}{\sin \alpha} \text{ (mm)}$$

b:Chip width(mm) a_p:Axial depth of cut (mm)

● Chip area

$$A = h * b = a_p * f \text{ (mm}^2\text{)}$$

A:Chip area(mm²) a_p:Axial depth of cut (mm)
f:Feed rate(mm/rev)

● Cutting force

$$F_c = K_c * a_p * f \text{ (N)}$$

F_c:Cutting force(N) K_c:Unit cutting force(N/mm²)
a_p:Axial depth of cut (mm) f:Feed rate(mm/rev)

● Cutting power

$$P_{mot} = \frac{K_c * V_c * a_p * f}{60000 * \eta} \text{ (KW)}$$

P_{mot}:Cutting power(KW) K_c:Unit cutting force(N/mm²)
V_c:Cutting speed(m/min) a_p:Axial depth of cut (mm)
f:Feed rate(mm/rev) η:Mechanical efficiency

● Chip removal

$$Q = a_p * f * V_c \text{ (cm}^3\text{/min)}$$

Q:Chip removal(cm³/min) a_p:Axial depth of cut (mm)
f:Feed rate(mm/rev) V_c:Cutting speed(m/min)

● Theoretic surface roughness

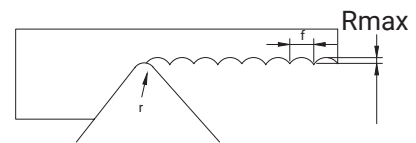

$$R_{max} = \frac{f^2}{8 * r} * 1000 \text{ (um)}$$

R_{max}:Theoretic surface roughness (um)
f:Feed rate(mm/rev) r:Corner radius (mm)



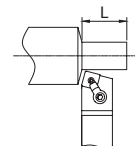



● Work time

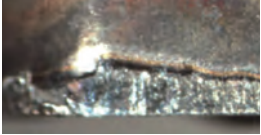

$$T_c = \frac{L}{f * n} \text{ (min)}$$

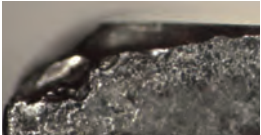
T_c:Work time f:Feed rate(mm/rev)
n:Spindle speed(rev/min) L: Working length(mm)

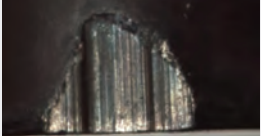
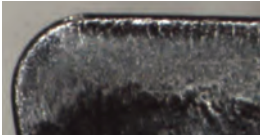
Turning Insert Normal Failures & Solutions

Failures	Pic.	Analysis	Solution
Flank wear		<ul style="list-style-type: none"> • Tool materials too soft • Excessive cutting speed • Less clearance angle • Less feed rate • Insufficient cooling 	<ul style="list-style-type: none"> • Choosing high wear-resistance insert grade • Reduce cutting speed • Enlarge clearance angle • Increase feed rate
Crater wear		<ul style="list-style-type: none"> • Tool materials too soft • Excessive cutting speed • Excessive feed rate 	<ul style="list-style-type: none"> • Choosing high wear-resistance insert grade • Reduce cutting speed • Reduce feed rate • Increasing the flow of coolant
Chipping		<ul style="list-style-type: none"> • Tool materials too hard • Less cutting strength 	<ul style="list-style-type: none"> • Choosing tougher grade • Enhancing cutting edge strength
Deformation		<ul style="list-style-type: none"> • Tool materials too soft • Over strong cutting edge • Excessive cutting depth & feed rate • Insufficient cooling 	<ul style="list-style-type: none"> • Choosing high wear-resistance insert grade • Reduce cutting speed • reduce cutting depth & feed rate • Choosing good thermal conductivity grade • Increasing the flow of coolant
Built-up edge		<ul style="list-style-type: none"> • Less cutting speed • Cutting edge not sharp • Unsuitable grade • Insufficient cooling 	<ul style="list-style-type: none"> • Increase cutting rate • Choosing sharp geometry • Choosing less adhesion grade • Increasing the flow of coolant
Mechanical wear		<ul style="list-style-type: none"> • Excessive feed rate and cutting depth • Vibration 	<ul style="list-style-type: none"> • Choosing tougher grade • Enlarge lead angle • Choosing bigger corner radius • Change to strong rigidity holder
Thermal cracking		<ul style="list-style-type: none"> • Excessive cutting heat • change of edges 	<ul style="list-style-type: none"> • Choosing dry cutting or adequate cooling • Choosing tougher grade
Peripheral wear		<ul style="list-style-type: none"> • Excessive feed rate & cutting speed • Tool materials too soft 	<ul style="list-style-type: none"> • Choosing high wear-resistance tool grade • Enlarge rake angle leads to sharp edge • Reduce cutting speed
Coating peeling		<ul style="list-style-type: none"> • Sticky chip on the cutting edge • Chip evacuation failure 	<ul style="list-style-type: none"> • Enlarge rake angle leads to sharp edge • Use chip breaker with bigger space

Milling Grades Conversion Table

ISO classification	ACHTECK	COROMANT	ISCAR	KENNAMETAL	KORLOY	KYOCERA	MITSUBISHI	SECO	SUMITOMO	TAEGUTEC	TUNGALOY	WALTER
P	AP301U AC301P	GC4220 GC4230	IC950	KC522M KC635M	PC3600 PC3500 PC3535 PC3525	PR630 PR660 PR730	VP15TF	MP1500 MP2500 T250M		TT7080 TT7030	T3130 AH330	WKP25 WAM10 WAM20
	AP351U	GC1030 GC4240	IC808 IC908	KC522M KC635M KC725M	PC5300 NC5330 PC9530	PR9925 PR830	VP15TF VP20RT	F30M MP3000	ACP2000	TT9080 TT9030	AH120 AH725 AH730 GH330	WAM30
	AP401U	GC1040	IC830 IC330 IC928	KC735M KC935M	PC3545		VP30RT FH7020X F7030	F40M MP2500	ACP300 ACZ350	TT8020 TT7800 TT8080	AH140 T3130 AH130	WKP235 WXP45 WSP45
M S	AP301U	GC1030 GC2030	IC808 IC908	KC635M	PC5300 NC5330 PC9530	PR730 PR830 PR925 PR1025	VP15TF	MP2500 F30M	ACP2000	TT9300 TT9080	T3130 AH725 AH120	WAM30 WXM35
	AP351U	GC2040 S40T	IC830 IC330 IC928	KC7725M	PC3545 PC5300	PR1225 PR905	VP30RT MP9030 F7030	F40M MM4500 MS2500	ACP300 EH20Z EH520Z	TT8020 TT8080	AH130 AH140 SH730	WXM35 WSM35 WSP45
K	AC301K AP351K	GC3220 GC4220	IC810 IC910	KCK15 KC520M	PC6510 PC215K PC5300	PR905 PR510 PR610	MC5020 VP15TF MP8010	MK2050 MK2000 MK3000	ACK2000 ACK3000 ACZ310	TT6080	T1115 AH120 GH110	WKP25 WKP35

High Feed Cutter AHM15-XD Application Information

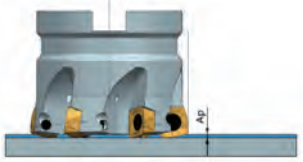
Face milling	Maximum milling depth a_p (mm)		
	a_p .max	XD..0904	XD..1205
		1.5	2.5

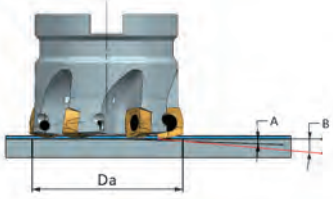
Ramping	Maximum bevel				
	D_a (mm)	XD..0904		XD..1205	
		Maximum bevel A	Maximum bevel B	Maximum bevel A	Maximum bevel B
	25	2.80°	6.30°	-	-
	32	1.50°	5.00°	-	-
	40	0.80°	2.70°	-	-
	52	-	-	0.8°	2.7°
	63	-	-	0.6°	1.8°
	66	-	-	0.45°	1.8°
	100	-	-	0.32°	1.45°
125	-	-	0.24°	1.06°	

A=Maximum bevel angle of full flat contact B= Maximum bevel of full contact + radius

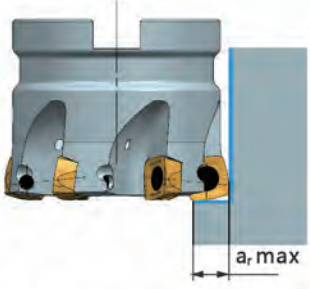
Plunging	Maximum milling depth a_r (mm)		
	D_a (mm)	XD..0904	XD..1205
	25	6.0	Maximum bevel A
	32	6.0	-
	40	6.0	-
	50	6.0	-
	52	-	9.0
	63	-	9.0
	66	-	9.0
	80	-	9.0
	100	-	9.0
25	-	9.0	

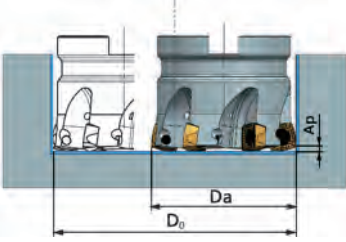
Circular Interpolation Milling	Diameter range of hole that can be milled in one pass (mm)				
	Da (mm)	XD..0904		XD..1205	
		D _o min (mm)	D _o max (mm)	D _o min (mm)	D _o max (mm)
	25	30	50	-	-
	32	51	64	-	-
	40	67	80	-	-
	50	87	100	-	-
	52	-	-	87.2	104
	63	-	-	109.2	126
	66	-	-	115.2	132
	80	-	-	143.2	160
	100	-	-	183.2	200
	25	-	-	233.2	250

Programming Information

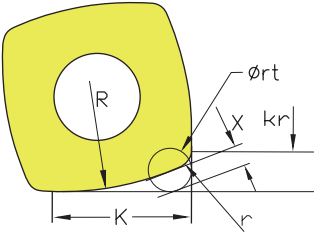
Circular Interpolation Milling	Indexable insert						
	R	r	rt	k	kr	x	
	XD..090408	17	0.8	2.0	6.5	1.9	1.47
	XD..120508	22.8	0.8	2.5	8.4	2.4	1.00
	XD..120512	20	1.2	3.0	8.3	2.8	0.86
	XD..120520	20	2.0	3.0	8.0	3.4	0.90

When programmed with the theoretical tool radius "rt", the maximum deviation shown above is produced with the final contour.
 Minor deviations that occur only in rounded corners can be corrected by other tools in subsequent process.

High Feed Cutter AHM20-LN06 Application Information

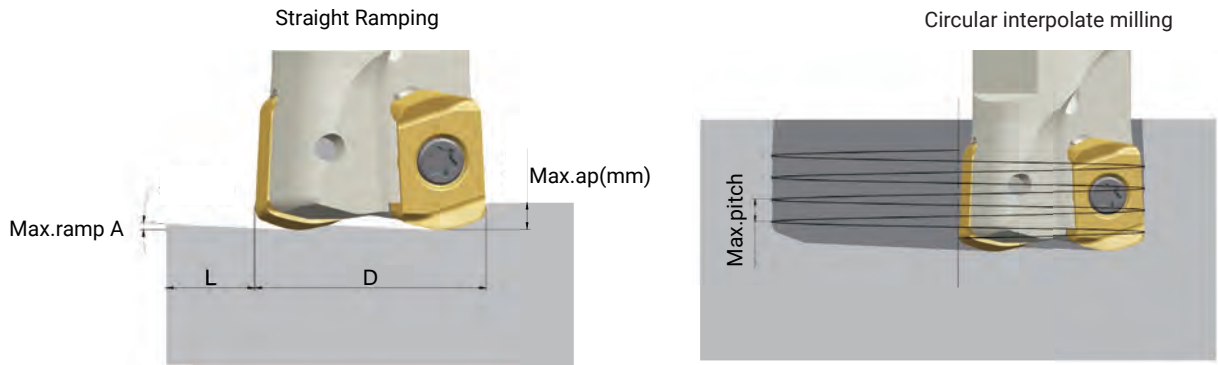

Cutter Dia(D)	Straight ramp down			Circular interpolate milling	
	Max.ramp-A	Max.ap(mm)	Min.length-L(mm)	Min.Dia.(mm)	Max.Dia(mm)
φ16	2.9°	0.7	13.8	23	32
φ17	2.6°	0.7	15.4	25	34
φ20	1.9°	1.0	30.1	31	40
φ21	1.8°	1.0	31.8	33	42
φ25	1.3°	1.0	44.0	41	50
φ26	1.3°	1.0	44.0	43	52
φ32	0.9°	1.0	63.6	55	64
φ33	0.9°	1.0	63.6	57	66
φ40	0.7°	1.0	81.8	71	80
φ50	0.5°	1.0	114.5	91	100
φ63	0.4°	1.0	143.2	117	126

NC Program Radius

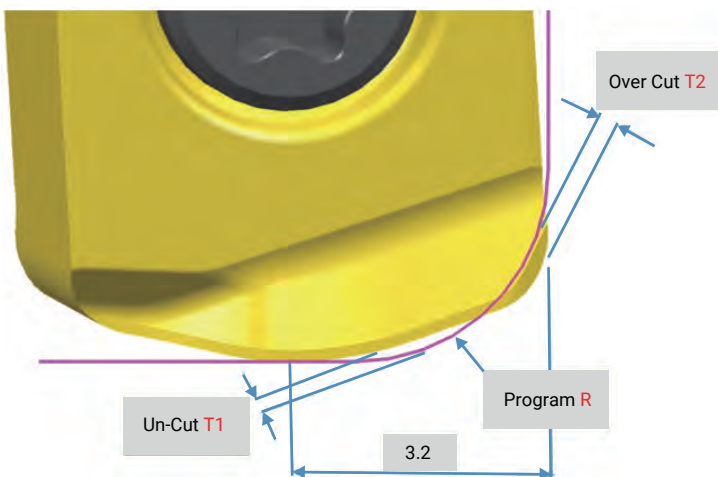

Technical information for NC program

Program R	Un-Cut T1	Over-Cut T2
R1.5	0.43	0
R2.0	0.29	0.06
R2.5	0.15	0.24

Note: select R1.5 as program R , without over-cut.

Ramping Milling Parameters

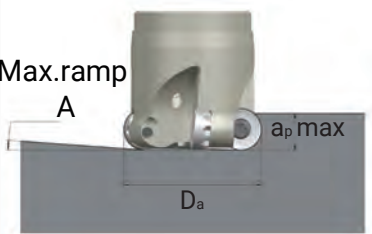
Ramping		Maximum angle A (°)				
	Da(mm)	Indexable inserts diameter d (mm)				
		d8	d10	d12	d16	d20
	25	3.2	6.5	-	-	-
	32	-	3.0	4.2	-	-
	40	-	1.4	3.0	-	-
	50	-	2.0	2.1	-	-
	63	-	-	1.5	2.6	-
	80	-	-	1.4	1.4	-
	100	-	-	-	1.0	1.3
	125	-	-	-	-	0.9
160	-	-	-	-	0.7	
ap max(mm)	6.6	8.8	10.7	14	17.2	

Circular Interpolate Milling Parameters

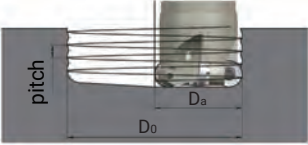
Actual circular interpolate milling data on workpiece		Diameter range of the hole that can be milled by one pass (mm)									
	Da(mm)	Indexable inserts diameter d (mm)									
		d8		d10		d12		d16		d20	
		DO min (mm)	DO max (mm)	DO min (mm)	DO max (mm)	DO min (mm)	DO max (mm)	DO min (mm)	DO max (mm)	DO min (mm)	DO max (mm)
	25	36.5	50	32	50	-	-	-	-	-	-
	32	-	-	46	64	42.5	64	-	-	-	-
	40	-	-	62	80	59	80	-	-	-	-
	50	-	-	82	100	78.5	100	97.5	126	-	-
	63	-	-	-	-	104.5	126	131.5	160	-	-
	80	-	-	-	-	138	160	171.5	200	-	-
	100	-	-	-	-	-	-	-	-	165.5	200
125	-	-	-	-	-	-	-	-	215.5	250	
160	-	-	-	-	-	10.7	-	-	285.5	320	

Technical guide

Milling General Formula

● **Cutting speed**

$$V_c = \frac{\pi * D_c * n}{1000} \text{ (m/min)}$$

V_c:Cutting speed(m/min) π: ≈3.14
D_c:Cutter diameter(mm) n:Spindle speed(rev/min)

● **Spindle speed**

$$n = \frac{1000 * V_c}{\pi * D_c} \text{ (rev/min)}$$

V_c:Cutting speed(m/min) π: ≈3.14
D_c:Cutter diameter(mm) n:Spindle speed(rev/min)

● **Feed speed**

$$V_f = f_z * n * Z \text{ (mm/min)}$$

V_f:Feed speed(mm/min) f_z:Feed per tooth(mm/z)
n:Spindle speed(rev/min) Z:Number of teeth

● **Feed rate per rev.**

$$f_z = \frac{V_f}{n * Z} \text{ (mm/z)}$$

f_z:Feed rate per rev.(mm/z) V_f:Feed speed(mm/min)
n:Spindle speed(rev/min) Z:Number of teeth

● **Feed rate per rev.**

$$f = \frac{V_f}{n} \text{ (mm/rev)}$$

f:Feed rate per rev.(mm/rev) V_f:Feed speed(mm/min)
n:Spindle speed(rev/min)

● **Time of cut**

$$T_c = \frac{L}{V_f} \text{ (min)}$$

T_c:Time of cut(min) L:Length of feed(mm)
V_f:Feed speed(mm/min)

● **Horse power**

$$H_p = \frac{P_{mot}}{0.75}$$

H_p:Horse power P_{mot}:Cutting power(KW)

● **Power demand**

$$P_{mot} = \frac{a_p * a_e * V_f * K_c}{6 * 10^7 * \eta} \text{ (KW)}$$

P_{mot}:Cutting power(KW) a_p:Cutting depth a_e:Cutting width
K_c:Unit cutting force(N/mm²) η:Machine efficiency coefficient(0.7-0.95)

● **Average chip thickness**

$$h_m = \frac{114.7 * f_z * \sin \psi * (a_e/D_c)}{\psi} \text{ (mm)}$$

h_m:Average chip thickness f_z:Feed per tooth(mm/z)
a_e:Cutting width D_c:Cutter diameter(mm) ψ:Pressure angle

● **Feed force**

Cutter in the center site

$$\psi_s = 2 * \arcsin \left(\frac{a_e}{D_c} \right) [^\circ]$$

Cutter in excentric site

$$\psi_s = 90^\circ + \arcsin \frac{a_e - (D_c/2)}{(D_c/2)} [^\circ]$$

ψ_s:Pressure angle a_e:Cutting width
D_c:Cutter diameter(mm)

● **Chip removal**

$$Q = \frac{a_p * a_e * V_f}{1000} \text{ (cm}^3\text{/min)}$$

Q:Chip removal(cm³/min) a_p:Cutting depth
a_e:Cutting width V_f:Feed speed(mm/min)

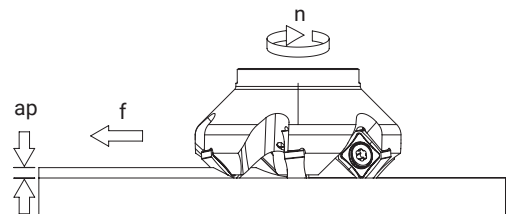
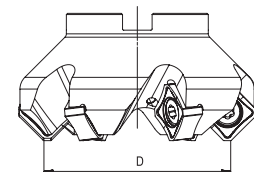

Drilling General Recommendation

● **Cutting speed**

$$V_c = \frac{\pi * D_c * n}{1000} \text{ (m/min)}$$

V_c:Cutting speed(m/min) π:≈3.14
D_c:Drill diameter(mm) n:Spindle speed(rev/min)

● **Spindle speed**

$$n = \frac{1000 * V_c}{\pi * D_c} \text{ (rev/min)}$$

V_c:Cutting speed(m/min) π:≈3.14
D_c:Drill diameter(mm) n:Spindle speed(rev/min)

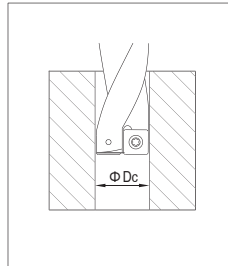

● **Feed speed**

$$V_f = f_z * n * Z \text{ (mm/min)}$$

V_f:Feed speed(mm/min) f_z:Feed per tooth(mm/z)
n:Spindle speed(rev/min) Z:Number of teeth

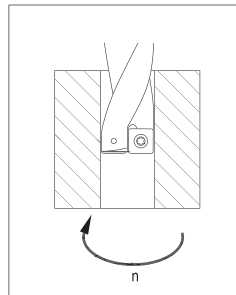

● **Feed rate per rev.**

$$f_z = \frac{V_f}{n * Z} \text{ (mm/z)}$$

f_z:Feed per tooth(mm/z) V_f:Feed speed(mm/min)
n:Spindle speed(rev/min) Z:Number of teeth

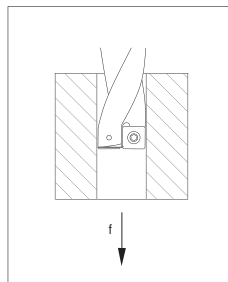

● **Feed rate per rev.**

$$f = \frac{V_f}{n} \text{ (mm/rev)}$$

f:Feed rate per rev.(mm/rev) V_f:Feed speed(mm/min)
n:Spindle speed(rev/min)

● **Chip removal**

$$Q = \frac{V_f * \pi * D_c^2}{4 * 1000} \text{ (cm}^3\text{/min)}$$

Q:Chip removal(cm³/min) V_f:Feed speed(mm/min)
π:≈3.14 D_c:Drill diameter(mm)

● **Horse power**

$$H_p = \frac{P_{mot}}{0.75}$$

H_p:Horsepower P_{mot}:Cutting power(KW)

● **Power demand**

$$P_{mot} = \frac{Q * K_c}{60000 * \eta} \text{ (KW)}$$

P_{mot}:Cutting power(KW) Q:Chip removal(cm³/min)
K_c:Unit cutting force(N/mm²)
η:Machine efficiency coefficient (0.7-0.95)

● **Torque**

$$M_c = \frac{D_c^2 * K_c * f}{8000} \text{ (N*m)}$$

M_c:Torque D_c:Drill diameter(mm)
K_c:Unit cutting force(N/mm²) f:Feed rate per rev.(mm/rev)

● **Feed force**

$$F_f = 0.63 * \frac{f * D_c * K_c}{2} \text{ (N)}$$

F_f:Feed force f:Feed rate per rev.(mm/rev)
D_c:Drill diameter(mm) K_c:Unit cutting force(N/mm²)

● **Cutting thickness**

$$h = f_z * \text{sink} \text{ (mm)}$$

h:Cutting thickness(mm) f_z:Feed rate(mm/rev)

Hardness Conversion Table

Brinell Hardness 10 ball load 3000Kg		Micro Vickers Hardness HV	Rockwell Hardness				Shore's Hardness	Tensile Strength (approximate) kgf/mm
Master ball	WC ball HB		A scale 60kgf diamond brale HRA	B scale 100kgf 1/16in ball HRB	C scale 150kgf diamond brale HRC	D scale 100kgf diamond brale HRD		
-	-	1865	92.0	-	80	-	-	
-	-	1787	91.5	-	79	-	-	
-	-	1710	91.0	-	78	-	-	
-	-	1633	90.5	-	77	-	-	
-	-	1556	90.0	-	76	-	-	
-	-	1478	89.5	-	75	-	-	
-	-	1400	89.0	-	74	-	-	
-	-	1323	88.5	-	73	-	-	
-	-	1245	88.0	-	72	-	-	
-	-	1160	87.0	-	71	-	-	
-	-	1076	86.5	-	70	-	-	
-	-	1004	86.0	-	69	-	-	
-	-	940	85.6	-	68.0	76.9	97	
-	-	920	85.3	-	67.5	76.5	96	
-	-	900	85.0	-	67.0	76.1	95	
-	767	880	84.7	-	66.4	75.7	93	
-	757	860	84.4	-	65.9	75.3	92	
-	745	840	84.1	-	65.3	74.8	91	
-	733	820	83.8	-	64.7	74.3	90	
-	722	800	93.4	-	64.0	73.8	88	
-	712	-	-	-	-	-	-	
-	710	780	83.0	-	63.3	73.3	87	
-	698	760	82.6	-	62.5	72.6	86	
-	684	740	82.2	-	61.8	72.1	-	
-	682	737	82.2	-	61.7	72.0	84	
-	670	720	81.8	-	61.0	71.5	83	
-	656	700	81.3	-	60.1	70.8	-	
-	653	697	81.2	-	60.0	70.7	81	
-	647	690	81.1	-	59.7	70.5	-	
-	638	680	80.8	-	59.2	70.1	80	
-	630	670	80.6	-	58.8	69.8	-	
-	627	667	80.5	-	58.7	69.7	79	
-	601	640	79.8	-	57.3	68.7	77	
-	578	615	79.1	-	56.0	67.7	75	
-	555	591	78.4	-	54.7	66.7	73	
-	534	569	77.8	-	53.5	65.8	71	
-	514	547	76.9	-	52.1	64.7	70	
-	495	528	76.3	-	51.0	63.8	68	
-	477	508	75.6	-	49.6	62.7	66	
-	461	491	74.9	-	48.5	61.7	65	
-	444	472	74.2	-	47.1	60.8	63	
429	429	455	73.4	-	45.7	59.7	61	
415	415	440	72.8	-	44.5	58.8	59	
401	401	425	72.0	-	43.1	57.8	58	
388	388	410	71.4	-	41.8	56.8	56	
375	375	396	70.6	-	40.4	55.7	54	
363	363	383	70.0	-	39.1	54.6	52	
352	352	372	69.3	(110.0)	37.9	53.8	51	
341	341	360	68.7	(109.0)	36.6	52.8	50	
331	331	350	68.1	(108.5)	36.6	51.9	48	
321	321	339	67.5	(108.0)	34.3	51.0	47	
311	311	328	66.9	(107.5)	33.1	50.0	46	
302	302	319	66.3	(107.0)	32.1	49.3	45	
293	293	309	65.7	(106.0)	30.9	48.3	43	
285	285	301	65.3	(105.5)	29.9	47.6	-	
277	277	292	64.6	(104.5)	28.8	46.7	41	

Hardness Conversion Table

Brinell Hardness 10 ball load 3000Kg		Micro Vickers Hardness HV	Rockwell Hardness				Shore's Hardness	Tensile Strength (approximate) kgf/mm
Master ball	WC ball HB		A scale 60kgf diamond brale HRA	B scale 100kgf 1/16in ball HRB	C scale 150kgf diamond brale HRC	D scale 100kgf diamond brale HRD		
269	269	284	64.1	(104.0)	28	45.9	40	91
262	262	276	63.6	(103.0)	27	45.0	39	89
255	255	269	63.0	(102.0)	25	44.2	38	86
248	248	261	62.5	(101.0)	24	43.2	37	84
241	241	253	61.8	100	23	42.0	36	82
235	235	247	61.4	99	22	41.4	35	80
229	229	241	60.8	98.2	21	40.5	34	78
223	223	234	-	97.3	(18.8)	-	-	-
217	217	228	-	96.4	(17.5)	-	33	74
212	212	222	-	95.5	(16.0)	-	-	72
207	207	218	-	94.6	(15.2)	-	32	70
201	201	212	-	93.8	(13.8)	-	31	69
197	197	207	-	92.8	(12.7)	-	30	67
192	192	202	-	91.9	(11.5)	-	29	65
187	187	196	-	90.7	(10.0)	-	-	63
183	183	192	-	90	(9.0)	-	28	63
179	179	188	-	89	(8.0)	-	27	61
174	174	182	-	87.8	(6.4)	-	-	60
170	170	178	-	86.8	(5.4)	-	26	58
167	167	175	-	86	(4.4)	-	-	57
163	163	171	-	85	(3.3)	-	25	56
156	156	163	-	82.9	(0.9)	-	-	53
149	149	156	-	80.8	-	-	23	51
143	143	150	-	78.7	-	-	22	50
137	137	143	-	76.4	-	-	21	47
131	131	137	-	74	-	-	-	46
126	126	132	-	72	-	-	20	44
121	121	127	-	69.8	-	-	19	42
116	116	122	-	67.6	-	-	18	41
111	111	117	-	65.7	-	-	17	39

Material Conversion Table

ISO	Country and standard										
	China	International	Germany	U.S.A.	U.K.		France	Sweden	Italy	Spain	Japan
	GB	DIN	W.-nr	AISI/SAE	BS	EN	AFNOR	SS	UNI	UNE	JIS
P	Structural steel										
	15	C15	1.0401	1015	080M15	-	CC12	1350	C15C16	F.111	-
	20	C22	1.0402	1020	050A20	2C	CC20	1450	C20C21	F.112	-
	35	C35	1.0501	1035	060A35	-	CC35	1550	C35	F.113	-
	45	C45	1.0503	1045	080M40	-	CC45	1650	C45	F.114	-
	55	C55	1.0535	1055	070M55	-	-	1655	C55	-	-
	60	C60	1.0601	1060	080A62	43D	CC55	-	C60	-	-
	Y15	9SMn28	1.0715	1213	230M07	-	S250	1912	CF9SMn28	11SMn28	SUM22
	-	9SMnPb28	1.0718	12L13	-	-	S250Pb	1914	CF9MnPb28	11SMnPb28	SUM22L
	-	10SPb20	1.0722	-	-	-	10PbF2	-	CF10Pb20	10SPb20	-
	-	35S20	1.0726	1140	212M36	8M	35MF4	1957	-	F210G	-
	Y13	9SMn36	1.0736	1215	240M07	1B	S300	-	CF9SMn36	12SMn35	-
	-	9SMnPb36	1.0737	12L14	-	-	S300Pb	1926	CF9SMnPb36	12SMnP35	-
	55Si2Mn	55Si9	1.0904	9255	250A53	45	55S7	2085	55Si8	56Si7	-
	-	60SiCr7	1.0961	9262	-	-	60SC7	-	60SiCr8	60SiCr8	-
	15	Ck15	1.1141	1015	080M15	32C	XC12	1370	C16	C15K	S15C
	40Mn	40Mn4	1.1157	1039	150M36	15	35M5	-	-	-	-
	25	Ck25	1.1158	1025	-	-	-	-	-	-	S25C
	35Mn2	36Mn5	1.1167	1335	-	-	40Mn5	2120	-	36Mn5	SMn438(H)
	30Mn	28Mn6	1.117	1330	150M28	14A	20M5	-	C28Mn	-	SCMn1
	35Mn	Cf35	1.1183	1035	060A35	-	XS38TS	1572	C36	-	S35C
	Ck45	45	1.1191	1045	080M46	-	XC42	1672	C45	C45K	S45C
	55	Ck55	1.1203	1055	070M55	-	XC45	-	C50	C55K	S55C
	50	Cf53	1.1213	1050	060A52	-	XC48TS	1674	C53	-	S50C
	60Mn	Ck60	1.1221	1060	080A62	43D	XC60	1678	C60	-	S58C
	-	Ck101	1.1274	1095	060A96	-	-	1870	-	-	SUP4
	-	X120Mn12	1.3401	-	Z120M12	-	X120M12	-	XG120Mn12	X120Mn12	SCMnH/1
	GCr15	100Cr6	1.3505	52100	534A99	31	100C6	2258	100Cr6	F.131	SUJ2
	-	15Mo3	1.5415	ASTM A204Gr.A	1501-240	-	15D3	2912	16Mo3KW	16Mo3	-
	-	16Mo5	1.5426	4520	1503-245-420	-	-	-	16Mo5	16Mo5	-
	-	14Ni6	1.5622	ASTM A350LF5	-	-	16N6	-	14Ni6	15Ni6	-
	-	X8Ni9	1.5662	ASTM A353	1501-509; 510	-	-	-	X10Ni9	XBNi09	-

Material Conversion Table

ISO	Country and standard										
	China	International	Germany	U.S.A.	U.K.		France	Sweden	Italy	Spain	Japan
	GB	DIN	W.-nr	AISI/SAE	BS	EN	AFNOR	SS	UNI	UNE	JIS
P	Structural steel										
	-	12Ni19	1.5680	2515	-	-	Z18N5	-	-	-	-
	-	36NiCr6	1.5710	3135	640A35	111A	35NC6	-	-	-	SNC236
	-	14NiCr10	1.5732	3415	-	-	14NC11	-	16NiCr11	15NiCr11	SNC415 (H)
	-	14NiCr14	1.5752	34153310	655M13655A12	36A	12NC15	-	-	-	SNC815 (H)
	-	36CrNiMo4	1.6511	9840	816M40	110	40NCD3	-	38CrNiMo4 (KB)	35CrNiMo4	-
	-	21NiCrMo2	1.6523	8620	850M20	362	20NCD2	2503	20NiCrMo2	20NiCrMo2	SNCCM220 (H)
	-	40NiCrMo2	1.6546	8740	311-Type7	-	-	-	40NiCrMo2 (KB)	40NiCrMo2	SNC240
	40CrNiMoA	34CrNiMo6	1.6582	4340	817M40	24	35NCD6	2541	35CrNiMo6 (KB)	-	-
	-	17CrNiMo6	1.6587	-	820A16	-	18NCD6	-	-	14CrNiMo1	-
	15Cr	15Cr3	1.7015	5015	523M15	-	12C3	-	-	-	SCr415(H)
	35Cr	34Cr4	1.7033	5132	530A32	18B	32C4	-	34Cr4(KB)	35Cr4	SCr430(H)
	40Cr	41Cr4	1.7035	5140	530M40	18	42C4	-	41Cr4	42Cr4	SCr440(H)
	40Cr	42Cr4	1.7045	5140	-	-	-	2245	-	42Cr4	SCr440
	18CrMn	16MnCr15	1.7131	5115	(527M20)	-	16MC5	2511	16MnCr15	16MnCr15	-
	20CrMn	55Cr3	1.7176	5155	527A60	48	55C3	-	-	-	SUP9(A)
	30CrMo	25CrMo4	1.7218	4130	1717CDS110	-	25CD4	2225	25CrMo4 (KB)	55Cr3	SCM420; SCM430
	35CrMo	34CrMo4	1.7220	4137;4135	708A37	19B	35CD4	2234	35CrMo4	34CrMo4	SCM432; SCR3M3
	40CrMoA	41CrMo4	1.7223	4140;4142	708M40	19A	42CD4TS	2244	41CrMo4	41CrMo4	SCM440
	42CrMo 42CrMnMo	42CrMo4	1.7225	4140	708M40	19A	42CD4	2244	42CrMo4	42CrMo4	SCM440(H)
	-	15CrMo5	1.7262	-	-	-	12CD4	2216	-	12CrMo4	SCM415(H)
	-	13CrMo44	1.7335	ASTMA182F11; F12	1501-620Gr.27	-	15CD3.5; 15CD4.5	-	14CrMo44	14CrMo45	-
	-	32CrMo12	1.7361	-	722M24	40B	30CD12	2240	32CrMo12	F.124.A	-
	-	10CrMo910	1.7380	ASTMA182F.22	1501- 622Gr.31;45	-	12CD9;10	2218	12CrMo9,10	TU.H	-
	-	14MoV63	1.7715	-	1503-660-440	-	-	-	-	13MoCrV6	-
	50CrVA	50CrV4	1.8159	6150	735A50	47	50CV4	2230	50CrV4	51CrV4	SUP10
	-	41CrAlMo7	1.8509	-	905M39	41B	40CAD6,12	2940	41CrAlMo7	41CrAlMo7	-
	-	39CrMoV139	1.8523	-	897M39	40C	-	-	36CrMoV12	-	-

Material Conversion Table

ISO	Country and standard										
	China	International	Germany	U.S.A.	U.K.		France	Sweden	Italy	Spain	Japan
	GB	DIN	W.-nr	AISI/SAE	BS	EN	AFNOR	SS	UNI	UNE	JIS
P	Tool steel										
	T10	C105W1	1.1545	W.110	-	-	Y1105	1880	C98KU C100KU	F.515 F.516	-
	T12A	C125W	1.1663	W.112	-	-	Y2120	-	C120KU	(C120)	SK20
	GCr15	100Cr6	1.2067	L3	BL3	-	Y100C6	-	-	100Cr6	-
	Cr12	X210Cr12	1.2080	D3	BD3	-	Z200Cr12	-	X210Cr13KU X250Cr12KU	X210Cr12	SKD1
	4Cr5MoVSi	X40CrMoV5 1	1.2344	H13	BH13	-	Z40CDV5	2242	X35CrMoV05KU X40CrMoV51KU	X40CrMoV5	SKD61
	Cr6WV	X100CrMoV5 1	1.2363	A2	BA2	-	Z100CDV5	2260	X100CrMoV51KU	X100CrMoV5	SKD12
	CrWMo	105WCr6	1.2419	-	-	-	105WC13	2140	10WCr6 107WCr5KU	105WCr5	SKS31 SKS2 SKS3
	Cr12W	X210CrW12	1.2436	-	-	-	-	2312	X215CrW12 1KU	X210CrW12	SKD2
	5CrNiMo	45WCrV7	1.2542	S1	BS1	-	-	2710	45WCrV8KU	45WCrSi8	-
	3Cr2W8V	X30WCrV93 X30WCrV93KU	1.2581	H21	BH21	-	Z30WCV9	-	X28W09KU X30WCrV9 3KU	X30WCrV9	SKD5
	Cr12MoV	X165CrMoV 12	1.2601	-	-	-	-	2310	X165CrMoW12KU	X160CrMoV12	SKD11
	5CrNiMo	55NiCrMoV6	1.2713	L6	-	-	55NCDV7	-	-	F.250.S	SKT4
	V	100V1	1.2833	W210	BW2	-	Y1105V	-	-	-	SKS43
	W6Mo5Cr4V2Co5	S6-5-2-5	1.3243	-	-	-	Z85WDKCV	2723	HS6-5-2-5	HS6-5-2-5	SKH55
	W18Cr4VCo5	S18-1-2-5	1.3255	T4	BT4	-	Z80WKCV 10-05-04-01	-	X78WCo1805KU	HS18-1-1-5	SKH3
	W6Mo5Cr4V2	S6-5-2	1.3343	M2	BM2	-	Z85WDCV 06-05-04-02	2722	X82WMo0605KU	HS6-5-2	SKH9
	-	S2-9-2	1.3348	M7	-	☒ Z ☒	Z100WCWV 09-02-04-02	2782	HS2-9-2	HS2-9-2	-
	W18Cr4V	S18-0-1	1.3355	T1	BT1	-	Z80WCV 18-04-01	-	X75W18KU	HS18-0-1	SKH2
	W6Mo5Cr4V3	S6-5-3	-	M3	-	-	-	-	-	-	SKH52
-	-	-	M42	BM42	-	-	-	-	-	SKH59	

Material Conversion Table

ISO	Country and standard										
	China	International	Germany	U.S.A.	U.K.		France	Sweden	Italy	Spain	Japan
	GB	DIN	W.-nr	AISI/SAE	BS	EN	AFNOR	SS	UNI	UNE	JIS
M	Stainless steel										
	0Cr13; 1Cr12	403	1.4000	403	403S17	-	Z6C13	2301	X6Cr13	F.3110	SUS403
	-	-	1.4001	-	-	-	-	-	-	F.8401	-
	1Cr13	410	1.4006	410	410S21	56A	X12Cr13	2302	X12Cr13	F.3401	SUS410
	1Cr17	430	1.4016	430	430S15	60	X8Cr17	220	X8Cr17	F.3113	SUS430
	2Cr13	410	1.4021	40	S62	56B;56C	X20C13	-	X20C13	F.3401	SUS410
	-	-	1.4027	-	420C29	56B	-	-	-	-	SCS2
	4Cr13	-	1.4034	-	420S45	56D	X40Cr14	2304	X40Cr14	F.3405	SUS420J2
	1Cr17Ni2	431	1.4057	431	431S29	57	X16CrNi16	2321	X16CrNi16	F.3427	SUS431
	Y1Cr17	430F	1.4104	430F	-	-	X10CrS17	2383	X10CrS17	F.3117	SUS430F
	1Cr17Mo	434	1.4113	434	434S17	-	X8CrMo17	2325	X8CrMo17	-	SUS434
	-	-	1.4313	-	425C11	-	-	-	-	-	SCS5
	-	-	1.4408	-	316C16	-	-	-	-	F.8414	SCS14
	4Cr9Si2	HW3	1.4718	HW3	401S45	52	X45CrSi8	-	X45CrSi8	F.322	SUH1
	0Cr13Al	405	1.4724	405	403S17	-	X10CrAl12	-	X10CrAl12	F.311	SUS405
	Cr17	430	1.4742	430	430S15	60	X8Cr17	-	X8Cr17	F.3113	SUS430
	8Cr20Si2Ni	HNV6	1.4757	HNV6	443S65	59	X80CrSiNi20	-	X80CrSiNi20	F.320V	SUH4
	2Cr25N	446	1.4762	446	-	-	X16Cr26	2322	X16Cr26	-	SUH446
	Austenitic stainless steel										
	0Cr18Ni9	X5CrNi1810	1.4301	304	304S15	58E	Z6CN18.09	2332	X5CrNi1810	F.3551 F.3541; F.3504	SUS304
	1Cr18Ni9MoZr	X10CrNiS189	1.4305	303	303S21	58M	Z10CNF18.09	2346	X10CrNiS18.09	F.3508	SUS303
	0Cr19Ni10	X2CrNi1911	1.4306	304L	304S12	-	Z2CN18.10	2352	X2CrNi18.11	F.3503	SCS19
	-	G-X6CrNi189	1.4308	-	304C15	-	Z6CN18.10M	-	-	-	SCS13
	Cr17Ni17	X12CrNi177	1.4310	301	-	-	Z12CN17.07	2331	X12CrNi1707	F.3517	SUS301
	-	X2CrNi1810	1.4311	304LN	304S62	-	Z2CN18.10	2371	-	-	SUS304LN
	0Cr19Ni9	X5CrNi189	1.4350	304	304S31	58E	Z6CN18.09	-	X5CrNi1810	-	SUS304
	0Cr17Ni11Mo2	X5CrNi Mo1712	1.4401	316	316S16	Z6CND 17.11	1.4401	2347	X5CrNiMo1712	F.3543	SUS316
	00Cr17Ni13Mo2	X2CrNi Mo17133	1.4429	316LN	-	-	Z2CND17.13	2375	-	-	SUS316LN
0Cr27Ni12Mo3	X2CrNi Mo18143	1.4435	316L	316S12	-	Z2CDN17.13	2353	X2CrNiMo1713	-	SCS16	
00Cr19Ni13Mo3	X2CrNi Mo17133	1.4438	317L	317S12	-	Z2CND19.15	2367	X2CrNiMo18.16	-	SUS317L	
-	X8CrNiMo275	1.4460	329L	-	-	-	2324	-	-	SUS329L; SCH11; SCS11	

Material Conversion Table

ISO	Country and standard										
	China	International	Germany	U.S.A.	U.K.		France	Sweden	Italy	Spain	Japan
	GB	DIN	W.-nr	AISI/SAE	BS	EN	AFNOR	SS	UNI	UNE	JIS
M	Austenitic stainless steel										
	1Cr18Ni9Ti	X6CrNiTi1810	1.4541	321	2337	321S12	Z6CNT18.10	58B	X6CrNiTi1811	F.3553	SUS321
	1Cr18Ni11Nb	X6CrNiNb1810	1.4550	347	347S17	58F	Z6CNNb18.1	2338	X6CrNiTi1811	F.3552	SUS347
	Cr18Ni12Mo2Ti	X6CrNiMoTi17122	1.4571	316Ti	320S17	58J	Z6NDT17.12	2350	X6CrNiMoTi17	F.3535	-
	-	G-X5CrNiMoNb1810	1.4581	-	318C7	-	Z4CNDNb1812M	-	XG8CrNiMo18	-	SCS22
	Cr17Ni12Mo3Nb	X10CrNiMoNb1812	1.4583	318	-	-	Z6CNDNb1713B	-	X6CrNiMoTiNb17	-	-
	1Cr23Ni13	X15CrNiSi2012	1.4828	309	309S24	-	Z15CNS20.1	-	-	-	SUH309
	0Cr25Ni20	X12CrNi2521	1.4845	310S	310S24	-	Z12CN2520	2361	X6CrNi2520	F.331	SUH310
	Cr15Ni36W3Ti	X12NiCrSi3616	1.4864	330	-	-	Z12CNS35.1	-	-	-	SUH330
	-	G-X40NiCrSi3818	1.4865	-	330C11	-	-	-	XG50NiCr3919	-	SCH15
	5Cr2Mn9Ni4N	X53CrMnNiN219	1.4871	EV8	349S54; 321S12	☒ 58B	Z52CMN21.0	-	X53CrMnNiN219	-	SUH35
1Cr18Ni9Ti	X12CrNiTi189	1.4878	321	321S320	58C	Z6CNT18.12	-	X6CrNiTi1811	F.3523	SU321	

ISO	Country and standard									
	China	Germany	U.S.A.	U.K.	France	Sweden	Italy	Spain	Japan	
	GB	W.-nr	AISI/SAE	EN	AFNOR	SS	UNI	UNE	JIS	
K	Nodular cast iron									
	QT400-18	GGG40	60-40-18	400/17	FGS370-17	0717-02	GS370-17	FGE38-17	FCD400	
	QT450-10	--	65-45-12	420/12	FGS400-12	--	GS400-12	FGE42-12	FCD450	
	QT500-7	GGG50	70-50-05	500/7	FGS500-7	0727-02	GS500-7	FGE50-7	FCD500	
	QT600-3	GGG60	80-60-03	600/7	FGS600-2	0732-03	GS600-2	FGE60-2	FCD600	
	QT700-2	GGG70	100-70-03	700/2	FGS700-2	0737-01	GS700-2	FGE70-2	FCD700	
	QT800-2	GGG80	120-90-02	800/2	FGS800-2	0864-03	GS800-2	FGE80-2	FCD800	
	QT900-2	--	--	900/2	--	--	--	--	--	
	Grey cast iron									
	--	GG40	NO.60	--	FGL400	0140	--	--	--	
	HT350	GG35	NO.50	350	FGL350	0135	G35	FG35	FC350	
	HT300	GG30	NO.45	300	FGL300	0130	G30	FG30	FC300	
	HT250	GG25	NO.35	250	FGL250	0125	G25	FG25	FC250	
	HT200	GG20	NO.30	200	FGL200	0120	G20	FG20	FC200	
	HT150	GG15	NO.20	150	FGL150	0115	G15	FG15	FC150	
	HT100	--	--	100	--	0110	G10	--	FC100	

Material Conversion table

ISO	Country and standard									
	China	International	Germany	U.S.A.	U.K.	France	Sweden	Italy	Spain	Japan
	GB	DIN	W.-nr	AISI/SAE	BS	AFNOR	SS	UNI	UNE	JIS
N	Al-based alloy									
	ZAlSi7Mg	Al-Si7Mg(Fe)	~AlSi7Mg	356	LM25	A-S7G	4244	3599	-	AC4C
	ZAlSi7MgA	Al-Si7Mg	AlSi7Mg	A356.0	2L99	A-S7G03	-	8024	-	AC4C
	ZAlSi12	Al-Si12	AlSi12	413;B413.0	LM6	A-S13	4261	4514	-	AC3A
	ZAlSi9Mg	~Al-Si10Mg	AlSi9Mg	360	LM9	A-S9G;A-S10G	4253	3051	-	AC4A
	-	Al-Si5	AlSi5Mg	A 443.0	-	-	-	5077	-	-
	-	Al-Si5Fe	-	B443.0	-	-	-	GD-AISI5Fe	-	-
	-	(AlSi7Fe)	-	A444.0	-	-	-	-	-	-
-	Al-Si12Fe	-	413	LM20	~A-S12	4260	5079	-	ADC1	

ISO	Country and standard									
	China	International	Germany	U.S.A.	U.K.	France	Sweden	Italy	Spain	Japan
	GB	DIN	W.-nr	AISI/SAE	BS	AFNOR	SS	UNI	UNE	JIS
S	Ni-based alloy									
	-	S-NiCr13A16MoNb	LW2 4670	5391	mar ☒ 46	NC12AD	-	-	-	-
	-	NiCo15Cr10MoAlTi	LW2 4674	AMS 5397	-	-	-	-	-	-
	-	NiFe35Cr14MoTi	LW2.4662	5660	-	ZSNCDT42	-	-	-	-
	-	NiCr19Fe19NbMo	LW2.4668	5383	HR8	NC19eNB	-	-	-	-
	-	NiCr20TiAk	2.4631	-	Hr401.601	NC20TA	-	-	-	-
	-	NiCr19Co11MoTi	2.4973	AMS 5399	-	NC19KDT	-	-	-	-
	-	NiCr19Fe19NbMo	LW2.4668	AMS 5544	-	NC20K14	-	-	-	-
	-	-	2.4603	5390A	-	NC22FeD	-	-	-	-
	-	NiCr22Mo9Nb	2.4856	5666	-	NC22FeDNB	-	-	-	-
	-	NiCr20Ti	2.4630	-	HR5.203-4	NC20T	-	-	-	-
	-	NiCu30AL3Ti	2.4375	4676	3072-76	-	-	-	-	-
	Co-based alloy									
	-	CoCr20W15Ni	-	5537C,AMS	-	KC20WN	-	-	-	-
	-	CoCr22W14Ni	LW2.4964	5772	-	KC22WN	-	-	-	-
	Ti-alloy									
	-	TiAl5Sn2.5	3.7115.1	UNS R54520	TA14/17	T-A5E	-	-	-	-
	-	-	-	-	-	UNS R56400	-	-	-	-
	-	TiAl6V4	3.7165.1	-	TA10-13/ TA28	UNS R56401	-	T-A6V	-	-
	-	TiAl5V5Mo5Cr3	-	-	-	-	-	-	-	-
-	TiAl4Mo4Sn4Si0.5	3.7185	-	-	-	-	-	-	-	

Index

A		ATD - TM	128	DCGW-1-NL-05	93	O	
ACD - CH	126	ATD - TS	127	DCGW-2-NL-05	93	ODET	224
ACD - CM	125	ATPFR/L	112	DCMT-KC2	59	ODEW	224
ACD - CS	124	ATPIR/L	113	DCMT-PB1	58	ODHT	224
AFF40-LN12	176	ATSER/L	103	DCMT-PC2	58	ODMT	224
AFF40-LN15	176	ATSER/L-D	105	DCMW-KD5	59	ODMW	224
AFM40-ON05	152	ATSER/L-SW	106	DNGA-SL-1	77	ONHF	247
AFM42-OD04	148	ATSEFR/L	108	DNGA-SL-2	77	ONHU	225
AFM42-OD06	150	ATSEFR/L-OB	109	DNGA-SL-4	77	ONMU	225
AFM45-SD09	154	ATSIR/L	114	DNGA-1-NL-00	89	R	
AFM45-SD12	160			DNGA-2-NL-00	89	RCGT-NC2	69
AFM45-SN12	166	C		DNMA-KD5	44	RCMX	69
AFM45-SN19	166	CCET-F	56	DNMG-KC4	44	RCMX-PD8	69
AFM45-XN07	172	CCET-M	57	DNMG-MB2	42	RDHT	240
AFM45-XN09	174	CCGT-NC2	55	DNMG-MC3	43	RDHW	240
AFM45-XN09-W	174	CCGT-PA1	55	DNMG-MC4	43	RDMT	240
AFM75-SD09	156	CCGW-SL-1	82	DNMG-PB1	42	RDMW	240
AFM75-SD12	162	CCGW-SL-2	82	DNMG-PB3	42	RPM	242
AFM75-SN12	168	CCGW-1-NL-05	92	DNMG-PC3	42	RPMT	240
AFM88-SN12	170	CCGW-2-NL-05	92	DNMG-PC4	43	RPMW	240
AFM90-SD09	158	CNMG-PB1	38	DNMG-PD3	42	S	
AFM90-SD12	164	CNMG-PB3	38	DNMG-PD5	44	SCGT-NC2	61
AGPFR/L	111	CNMG-PC3	38	DNMG-SC3	43	SCHT	226
AGSIR/L	115	CNMG-PC4	39	D106-03-A0	289	SCMT	226
AGSFR/L	110	CNMG-PD3	38	D106-05-A0	293	SCMT-HT	61
AGUER/L	107	CNMG-PD5	40	D106-03-A1	297	SCMT-KC2	61
AGUIR/L	116	CNMG-SC3	39	D106-05-A1	301	SCMT-PB1	61
AHM15-XD09	208	CNMM-PC9	41	E		SCMT-PC2	61
AHM15-XD12	210	CNMM-PD8	41	EPMT	279	SCMW	226
AHM20-LN06	206	CNMM-PD9	41	G		SCMW-KD5	61
APE90-LN09	190	CCMT-KC2	56	GPAD	283	SDGT	227
APHT	280	CCMT-PB1	55	H		SDHT	227
APKT 1003	237	CCMT-PC2	55	HP-2D(SPMT)	254	SDHW	227
APKT 1705	238	CCMW-KD5	56	HP-2D(WCMT)	260	SDKT	227
APM00-RO08	196	CNGA-SL-1	76	HP-3D(SPMT)	256	SDMT	227
APM00-RO10	198	CNGA-SL-2	76	HP-3D(WCMT)	262	SDMW	227
APM00-RO12	200	CNGA-SL-4	76	HP-4D(SPMT)	258	SEKT	228
APM00-RO16	202	CNGA-1-NL-00	88	HP-4D(WCMT)	264	SNGA-SL-1	78
APM00-RO20	204	CNGA-2-NL-00	88	L		SNGA-SL-4	78
APM00-RP	194	CNMA-KD5	40	LNHQ	247	SNGA-SL-8	78
APMT	239	CNMG-KC4	40	LNHU	241	SNGX	229
APMT-DH	281	CNMG-MB2	38	LNHU 0904..	235	SNHX	229
APMT-LH	282	CNMG-MC3	39	LNHU 1607..	236	SNMA-KD5	47
ASM90-LN13	180	CNMG-MC4	39	LNHU 1308..	241	SNMG-KC4	46
ASM90-WN08	184	CNMM-PC8	41	L		SNMG-MB2	45
ASM90-LN09	178	D		LNMX	245	SNMG-MC3	45
ASM90-LN16	182	DCET-F	59	LNMX-HE	54	SNMG-MC4	46
ASM90-AP10	186	DCET-M	59	L		SNMG-PB1	45
ASM90-AP17	188	DCGT-NC2	58	LNHU	241	SNMG-PC3	45
ATD - E	132	DCGT-PA1	58	LNHU 0904..	235	SNMG-PC4	46
ATD - E-G	131	DCGW-SL-1	83	LNHU 1607..	236	SNMG-PD3	45
ATD - RA	130	DCGW-SL-2	83	LNHU 1308..	241	SNMG-PD5	46
ATD - RM	129						

SNMG-SC3	45	V		WNMG-MC4	53
SNMH-PC9	47	VBET-F	66	WNMG-PB1	52
SNMM-PC9	47	VBET-M	66	WNMG-PB3	52
SNMM-PD8	47	VBET-Y	67	WNMG-PC3	52
SNMM-PD9	47	VBGT-PA1	65	WNMG-PC4	53
SNMX	232	VBGW-SL-1	85	WNMG-PD3	52
SNMX-PD9	47	VBGW-SL-2	85	WNMG-PD5	53
SPMT	273	VBGW-1-NL-05	95	WNMG-SC3	52
		VBGW-2-NL-05	95		
		VBMT-KC2	66		
		VBMT-PB1	65		
		VBMT-PC2	65	X	
T		VCET-F	67	XDLT	246
TBET-F	64	VCGT-NC2	66	XDMW	246
TCET-M	64	VCGT-PA1	65	XNGU	233
TCGT-NC2	62	VCGW-SL-1	85	XNGX	234
TCGT-PA1	62	VCGW-SL-2	85	XNMU	233
TCGW-1-NL-05	94	VCGW-1-NL-05	95		
TCGW-3-NL-05	94	VCGW-2-NL-05	95		
TCMT-KC2	63	VCMT-PB1	65		
TCMT-PB1	62	VCMT-PC2	65		
TCMT-PC2	62	VNGA-SL-1	80		
TCMW-KD5	63	VNGA-SL-2	80		
TNGA-SL-1	79	VNGA-SL-4	80		
TNGA-SL-3	79	VNGA-1-NL-00	91		
TNGA-SL-6	79	VNGA-2-NL-00	91		
TNGA-1-NL-00	90	VNMG-KC4	51		
TNGA-3-NL-00	90	VNMG-MB2	51		
TNGG-F	50	VNMG-MC3	51		
TNGG-H	50	VNMG-PB1	51		
TNMA-KD5	50	VNMG-PB3	51		
TNMG-KC4	49	VNMG-PC3	51		
TNMG-MB2	48	VNMG-PC4	51		
TNMG-MC3	49	VNMG-PD3	51		
TNMG-MC4	49	VNMG-SC3	51		
TNMG-PB1	48	VPET-F	67		
TNMG-PB3	48	VPET-M	67		
TNMG-PC3	48	VPGT-NC2	66		
TNMG-PC4	49				
TNMG-PD3	48				
TNMG-PD5	50				
TNMG-PL5	48				
TNMG-SC3	48	W			
TNMM-PD8	50	WBET-F	68		
TPEH-F	64	WCMT(DG)	275		
TPGW-SL-1	84	WCMT(DU)	274		
TPGW-SL-3	84	WNGA-SL-1	81		
TPGW-1-NL-05	94	WNGA-SL-3	81		
TPGW-3-NL-05	94	WNGA-SL-6	81		
TPMT-DH	281	WNGU	243		
TPMT-LH	282	WNHU	243		
TPMT-PC2	62	WNHX	243		
TPMX-DH	283	WNMA-KD5	53		
		WNMG-KC4	53		
		WNMG-MB2	52		
		WNMG-MC3	52		

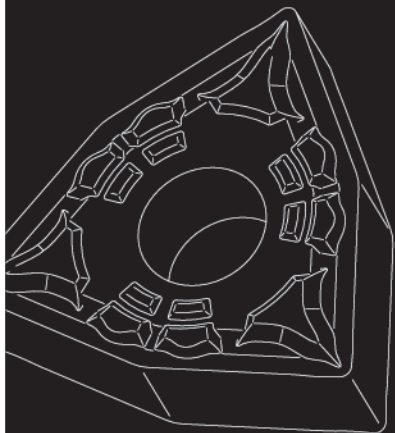

GANZHOU ACHECK TOOL TECHNOLOGY CO.,LTD

Address: Ganzhou Economic Development Area, Jiangxi , China

Postcode: 341000

Tele: 400-9150-887

Fax: 0797-8166100

E-mail: export@achtecktool.com

Website: www.achtecktool.com

