

2021
2022



MEASURING INSTRUMENTS

CATALOGUE NO. 205



QUALITY | INNOVATION | SERVICE | VALUE



The products with this mark are **INSIZE PLUS** brand, otherwise the products are **INSIZE** brand.

INSIZE is our standard quality

INSIZE PLUS is our premium quality

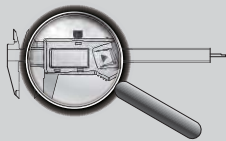


The products with this mark are supplied with manufacturer inspection certificate.

INSIZE		Inspection Certificate					
Product name	Digital Caliper	Traceable to	USA NIST No.821/279484-10				
Code No.	1108-150		Germany DKD No.D-K-15190-01-00				
Measuring range	0-150mm / 0-6"	Inspector	<i>Jose</i>				
Resolution	0.01mm / 0.0005"	Judgement	Passed				
Serial No.	0910120004						
Standard temperature	20°C / 68°F						
		Unit: inch			Unit: mm		
Measuring Length	Permissible Error	Error		Measuring Length	Permissible Error	Error	
		External	Internal			External	Internal
0.4 DIA	+0.0005 -0.0010	/	0.0005	Φ10	+0.01 -0.02	/	0.01
2	±0.0010	-0.0005	/	50	±0.02	-0.01	/
4		-0.0005	/	100		-0.01	/
6		-0.0010	/	150		-0.02	/
8		/	/	200		/	/
10	±0.0015	/	/	250	±0.03	/	/
12		/	/	300		/	/



Please scan QR code to watch the videos of products.



How to search:

1. Search for products according to category in PRODUCT INDEX (next 5 pages)
2. Search for products in CODE NO. INDEX (page 458~462)
3. Search for products in APPLICATION INDEX OF MEASURING TOOLS (page 463~468)

We reserve the right to change or modify the design and specification of products in this catalogue without prior notice.

Copyright © INSIZE CO., LTD. All Rights Reserved.
INSIZE is the registered trademark of INSIZE CO., LTD.



PRODUCT INDEX

1 DATA OUTPUT AND SOFTWARE PAGE 1-7



DATA MANAGEMENT SOFTWARE



WIRELESS DATA TRANSMISSION SYSTEM



DATA OUTPUT CABLES

4 HEIGHT MEASURING INSTRUMENTS PAGE 62-68



HIGH PRECISION HEIGHT GAGES



1D MANUAL HEIGHT GAGES



HEIGHT GAGES



MINI DIGITAL HEIGHT GAGES

2 CALIPERS PAGE 8-50



CALIPERS



DEPTH BASE ATTACHMENTS



ACCESSORY SET FOR DIGITAL CALIPERS



CALIPER END GRINDING MACHINE



UNIVERSAL COMPARISON GAGES



SPECIAL PURPOSE CALIPERS

3 DEPTH MEASURING INSTRUMENTS PAGE 50-62



DEPTH GAGES



EXTENSION BASES



DIAL DEPTH GAGES



DEPTH MICROMETERS

5 MICROMETERS PAGE 69-106



HIGH PRECISION DIGITAL MICROMETERS/SNAP GAGES



OUTSIDE MICROMETERS



INDICATING MICROMETERS



MICROMETERS WITH DIAL INDICATOR



SPECIAL PURPOSE MICROMETERS



3-WIRES



MICROMETER HEADS



OPTICAL PARALLELS



MICROMETER STANDS

6 BORE AND SHAFT DIAMETER MEASURING INSTRUMENTS PAGE 107-126



PISTOL GRIP THREE POINTS BORE GAGES



THREE POINTS INTERNAL MICROMETERS



INSIDE MICROMETERS



TUBULAR INSIDE MICROMETERS



BORE GAGES



BORE GAGE SETTERS



TELESCOPING GAGE SETS



DIGITAL RADIUS GAGES



CIRCUMFERENCE TAPES



MICROMETER LAPPING MACHINES

PRODUCT INDEX

7 DIGITAL AND DIAL INDICATORS

PAGE 126-169



DIGITAL INDICATORS



DIAL INDICATORS



POINTS



LINEAR GAGES



DIAL TEST INDICATORS



DIAL TEST INDICATOR HOLDERS



DIAL INDICATOR TESTERS



MAGNETIC STANDS



DIAL INDICATOR STANDS



CONCENTRICITY GAGES



BENCH CENTERS



SHANK RUNOUT TESTERS

9 STANDARDS AND GAGE BLOCKS

PAGE 188-213



GAGE BLOCKS



CALIPER INSPECTION GAGE BLOCK AND RING GAGE SET



MICROMETER INSPECTION GAGE BLOCK SET



GAGE BLOCK ACCESSORIES



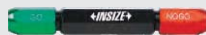
CHECK MASTERS



ANGLE GAGE BLOCKS



PIN GAGES



PIN GAGE HANDLES



SETTING RINGS



PLAIN PLUG GAGES



THREAD RING GAGES



THREAD PLUG GAGES



THREADED HOLE GAGES



STEEL BALLS

8 INDICATING MEASURING INSTRUMENTS

PAGE 170-187



INTERNAL CALIPER GAGES



EXTERNAL CALIPER GAGES



THICKNESS GAGES



DIAL SNAP GAGES



STEP AND GAP GAGES



CRANKSHAFT TESTERS



THREAD PITCH INSTRUMENTS



THREAD DIAMETER INSTRUMENTS



THREAD TAPER INSTRUMENTS



THREAD HEIGHT INSTRUMENTS

10 ANGLE AND STRAIGHTNESS MEASURING INSTRUMENTS

PAGE 214-228



DIGITAL PROTRACTORS



PROTRACTORS



UNIVERSAL PROTRACTORS



PERPENDICULARITY TESTERS



GRANITE SQUARES



SQUARES



STRAIGHT EDGES



MAGNALIUM STRAIGHT EDGES



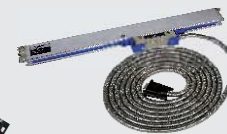
STRAIGHTNESS/FLATNESS GAGES

13 SCALES

PAGE 283-286



DIGITAL SCALES



LINEAR SCALES



DIGITAL READOUTS

PRODUCT INDEX

11 SIMPLE MEASURING TOOLS

PAGE 228-257



FEELER GAGES



PITCH GAGES



GEAR TOOTH PITCH GAGES



ANGLE GAGES



RADIUS GAGES



CHAMFER GAGES



TAPER SLOT GAGES



TAPER GAGES



TAPER BORE GAGES



WELDING GAGES



AMERICAN STANDARD WIRE GAGE



U.S. STANDARD SHEET METAL GAGE



DRILL POINT GAGE



DRILL ANGLE GAGE



INSIDE CALIPERS



OUTSIDE CALIPERS



DIVIDERS



MEASURING TAPES



MEASURING WHEELS



STEEL RULES



T-SHAPE MARKING GAGES



COMBINATION SQUARE SETS



SCRIBING CALIPERS



SCRIBERS



MEASURING TOOL SETS

14

PAGE 287-291



CMM



JIG SET FOR CMM



SURFACE PROFILE MEASURING MACHINE

12

PAGE 258-282



GRANITE SURFACE PLATES



STANDS FOR GRANITE SURFACE PLATES



MAGNETIC RECTANGULAR BLOCKS



V-BLOCK SETS



MAGNETIC V-BLOCKS



PERMANENT MAGNETIC CHUCKS



PARALLEL SETS



ANGLE PLATE SETS



ADJUSTABLE ANGLE BLOCKS



RIGHT ANGLE PLATES



SINE BARS



PRECISION UNIVERSAL VISES



PRECISION VISES



XY-AXIS STAGES



CENTERING INDICATOR



DIAL TEST INDICATOR CENTERING HOLDERS



EDGE FINDERS



ZERO SETTERS

15

PAGE 292-295



LASER SCAN MICROMETERS



AIR GAGE DISPLAY



AIR GAGES



OPTICAL TRANSMISSION PROBES

16

PAGE 296-312



TOOL PRESETTERS



VISION MEASURING SYSTEMS



PROFILE PROJECTORS

PRODUCT INDEX

17 MICROSCOPES

PAGE 313-352



TOOLMAKER MICROSCOPES



DIGITAL MICROSCOPES



DIGITAL MEASURING MICROSCOPE



INDUSTRIAL MICROSCOPES



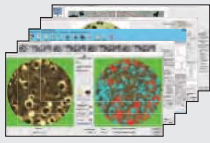
METALLURGICAL MICROSCOPES



ZOOM STEREO MICROSCOPES



DIGITAL CAMERAS



METALLURGICAL ANALYSIS SOFTWARE



PORTABLE MEASURING MICROSCOPES

18

PAGE 353-358



TABLE MAGNIFIERS



MAGNIFIERS



TELESCOPING INSPECTION MIRRORS



TELESCOPING MAGNETIC PICK-UPS

19 BORESCOPIES

PAGE 358-365



VIDEOSCOPES



PIPE VIDEOSCOPE



RIGID BORESCOPES

20 ROUGHNESS TESTERS

PAGE 366-371



ROUGHNESS TESTERS



SURFACE ROUGHNESS SPECIMENS

21 PORTABLE INSTRUMENTS

PAGE 372-395



COATING THICKNESS GAGES



CROSS CUT ADHESION TESTER



DIGITAL SURFACE PROFILE GAGES



WET FILM GAGES



ULTRASONIC THICKNESS GAGES



LASER DISTANCE METERS



INFRARED THERMOMETERS



INFRARED THERMAL CAMERAS



THERMAL SCANNERS



THERMOHYGROMETERS



LUX METERS



DIGITAL ANEMOMETERS



DIGITAL MOISTURE METERS



DIGITAL SOUND LEVEL METERS



DIGITAL TACHOMETERS



VIBRATION PENS



DIGITAL MULTIMETERS



DIGITAL CLAMP METERS



GLOSS METERS



SPECTROPHOTOMETER



TACHOMETER/STROBOSCOPE



PORTABLE REFRACTOMETERS



STROKE COUNTER

PRODUCT INDEX

22 LEVELS

PAGE 395-401



DIGITAL LEVEL AND SLOPE METERS



FRAME LEVELS



BLOCK LEVELS



ALUMINUM ALLOY LEVELS



CROSS-LINE LASER LEVELS

24 FORCE GAGES

PAGE 433-438



FORCE GAGES



TEST STANDS FOR FORCE GAGE



STRIPPING FORCE TEST STANDS



SPRING TESTERS



ELECTRONIC UNIVERSAL TESTING MACHINES



DIAL TENSION GAGES

25 TORQUE TESTERS TORQUE WRENCHES

PAGE 439-449



DIGITAL TORQUE TESTERS



TORQUE WRENCH TEST STANDS



DIGITAL TORQUE TESTERS



DIGITAL BOTTLE CAP TORQUE TESTERS



TORQUE SCREWDRIVERS



TORQUE WRENCHES



DIGITAL TORQUE ADAPTERS



TORQUE MULTIPLIER

23 HARDNESS TESTERS

PAGE 402-432



ROCKWELL HARDNESS TESTERS



BRINELL HARDNESS TESTERS



DIGITAL VICKERS HARDNESS TESTERS



DIGITAL MICRO-VICKERS HARDNESS TESTER



BRINELL INDENTATION MEASURING SYSTEM



VICKERS HARDNESS MEASURING SYSTEM



ULTRASONIC HARDNESS TESTER



LEEB HARDNESS TESTERS



MAGNETIC ROCKWELL HARDNESS TESTERS



PORTABLE ROCKWELL HARDNESS TESTERS



HYDRAULIC BRINELL HARDNESS TESTERS



BARCOL HARDNESS TESTERS



WEBSTER HARDNESS TESTERS



SHORE DUROMETERS



HARDNESS TEST BLOCKS



FRUIT HARDNESS TESTERS



CONCRETE STRENGTH TESTERS

26 SCALES

PAGE 450-455



ELECTRONIC BALANCES



WEIGHING SCALES



CRANE SCALES



PLATFORM SCALES



FLOOR SCALES



WEIGHTS

27

PAGE 456-457



CUTTING MACHINE

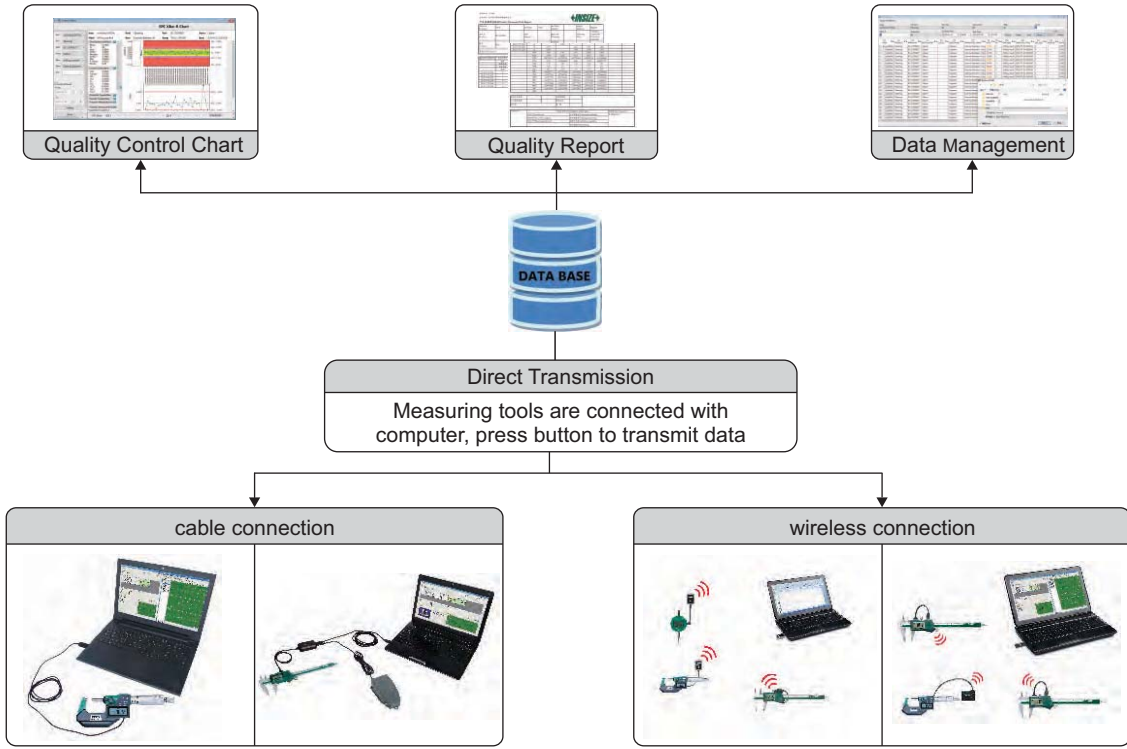


GRINDER AND POLISHER



MOUNTING PRESS

1 MEASURING DATA MANAGEMENT SOFTWARE CODE 7316-10

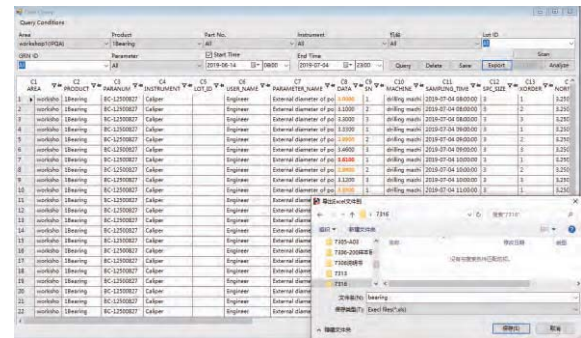
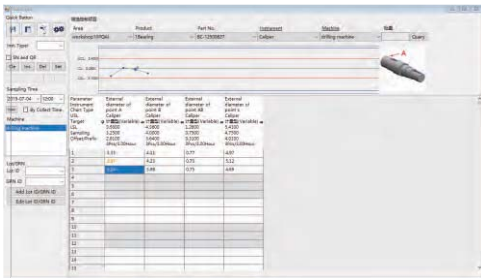


Direct Transmission

- Transmit data through cables or wireless systems

Data Management

- Measuring data are stored in database



Quality Control Chart

- Analyze the tendency of data, make production adjustment in advance

Quality Report

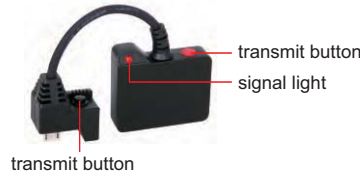
- Generate different EXCEL report formats according to requirements





WIRELESS DATA TRANSMISSION SYSTEM

- Transmission distance is 10 meter
- Press the button to transmit data
- 7315-2 is supplied with EXCEL directional input software, each measuring tool is only displayed in the specified area



transmitter
7315-21



receiver
7315-2



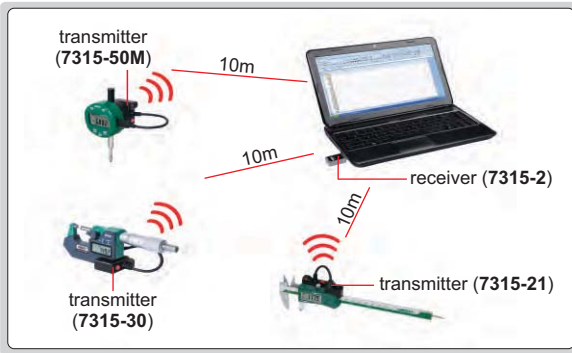
receiver
7315-3

Code	Description	Plug to product	Remark
7315-2	multichannel receiver		<ul style="list-style-type: none"> Connected with maximum 8 transmitters, each of them has unique identification code. Text format virtual com port, converted to keyboard format with supplied software (data can be transmitted to EXCEL, WORD etc. and any software which receives keyboard signal) Using EXCEL directional input software, the measurement data of different measuring tools can be transmitted to the specified area in the sheet.
7315-3	single channel receiver		<ul style="list-style-type: none"> Connected with 1 transmitter only, transmitter can be changed as needed. Recognized as HID keyboard device by computer, no need to install drivers and softwares Data can be transmitted to Excel, Word, txt and other files (press transmit button of transmitter, which is recognized by the computer as keyboard input data and press enter, such as 12.34) Suitable for any softwares which can receive keyboard signal
7315-21	transmitter for digital calipers		<p>digital calipers and digital depth gages</p>
7315-22	transmitter for large digital calipers		<p>large digital calipers (range ≤1000mm) and digital height gages</p>
7315-30	transmitter for digital micrometers		<p>digital micrometers</p>
7315-50M	transmitter for digital indicators		<p>digital indicators, digital thickness gages and digital internal/external caliper gages</p>
7315-60	transmitter for high precision digital indicators		<p>2140-6 and 2133 series high precision digital indicators 3350 series high precision digital snap gages</p>

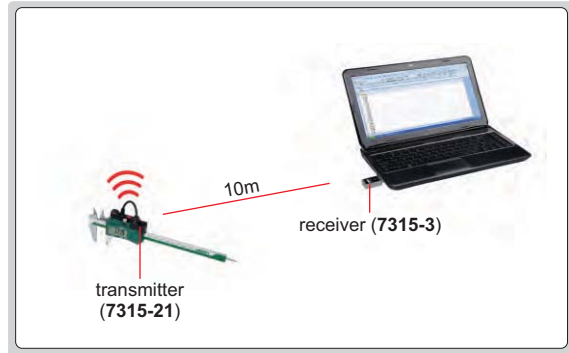
To be continued

Continued from previous page

7315-2 application (multichannel)



7315-3 application (single channel)



Excel directional input software (included in 7315-2), application example 1

Set the display area of caliper at B4-B9, the readings of caliper are displayed at B4, B5...B9. Set the display area of micrometer at C4-C9, the readings of micrometer are displayed at C4, C5... C9. Set the display area of height gage at D4-D9, the readings of height gage are displayed at D4, D5... D9.

	A	B	C	D
1	Project	Length	Width	Height
2	Dimension and Tolerance	50±0.05	24±0.01	10+0.05/-0.06
3	Measuring tool	Caliper	Micrometer	Height gage
4	1	50.02	24.004	9.98
5	2	50.01	24.010	10.01
6	3	49.99	23.990	10.02
7	4	50.00	23.996	9.99
8	5	50.04	24.000	10.01
9	6	Channel 1	Channel 2	Channel 3

Serial of workpieces

The next data display area is indicated in green

Excel directional input software (included in 7315-2), application example 2

Set the display area of micrometer at B4-C9, data input is from the left to the right, the readings of micrometer are displayed at B4, C4, B5, C5... B9, C9. Set the display area of caliper at D4-D9, the readings of caliper are displayed at D4, D5... D9. Set the display area of depth gage at E4-E9, the readings of depth gage are displayed at E4, E5... E9.

	A	B	C	D	E
1	Project	External diameter1	External diameter2	Length	Depth
2	Dimension and Tolerance	Φ23+0.01/-0.02	Φ21+0.01/-0.02	50±0.04	28±0.05
3	Measuring tool	Micrometer	Micrometer	Caliper	Depth gage
4	1	23.010	21.008	49.98	28.01
5	2	23.010	21.000	49.98	27.98
6	3	22.999	21.000	50	28
7	4	23.007	20.998	50	28
8	5	23.000	20.985	50.01	28.01
9	6	23.008	Channel 1	Channel 2	Channel 3

Serial of workpieces

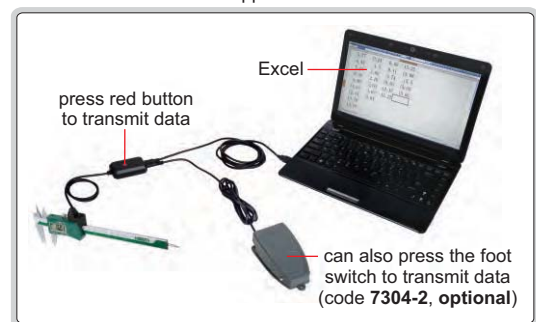
The next data display area is indicated in green

DATA OUTPUT CABLES (KEYBOARD FORMAT)



7302-40M

application



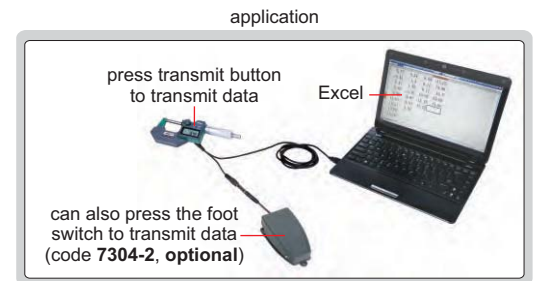
- Recognized as HID keyboard device by computer, no need to install drivers and softwares
- Data can be transmitted to Excel, Word, txt and other files (press transmit button, which is recognized by the computer as keyboard input data and press enter, such as 12.34↵)
- Suitable for any softwares which can receive keyboard signal
- Optional accessory: foot switch (code: 7304-2), hub (code: 7302-HUB, 7302-HUB7) extension cables (code: 7302-ADD5, 7302-ADD10)

To be continued

Continued from previous page

SEPARATED BUTTON

Code	Description	Plug to product	Plug to computer	Applicable products
7302-21	cable for digital calipers (length 3m)	transmit button		 digital calipers and digital depth gages
7302-22	cable for large digital calipers (length 2.5m)			 large digital calipers (range ≤1000mm) and digital height gages
7302-30	cable for digital micrometers (length 2.5m)			 digital micrometers
7302-40M	cable for digital indicators (length 2.5m)			 digital indicators
7302-50M	cable for digital gages (length 2.5m)			 digital thickness gages and digital internal/external caliper gages
7302-60	cable for high precision digital indicators (length 2.5m)			 2140-6 and 2133 series high precision digital indicators 3350 series high precision digital snap gages



INTEGRATED BUTTON

Code	Description	Plug to product	Plug to computer	Applicable products
7302-SPC10	cable for digital micrometers (length 1.8m)			 digital micrometers (code with suffix Q, such as 3101-25ACQ)

DATA OUTPUT CABLES (TEXT FORMAT, VIRTUAL COM PORT)

application









- Optional accessory: foot switch (code: 7304-2), hub (code: 7302-HUB, 7302-HUB7)

Single transmission (can be switched to continuous transmission)

Code	Description	Plug to product	Plug to computer	Applicable products
7305-21	cable for digital calipers (length 3m)			 digital calipers and digital depth gages
7305-R21				
7305-22	cable for large digital calipers (length 2.5m)			 large digital calipers (range ≤1000mm) and digital height gages
7305-R22				
7305-30	cable for digital micrometers (length 2.5m)			 digital micrometers
7305-R30				
7305-50M	cable for digital gages (length 2.5m)			 digital thickness gages and digital internal/external caliper gages
7305-R50M				

To be continued

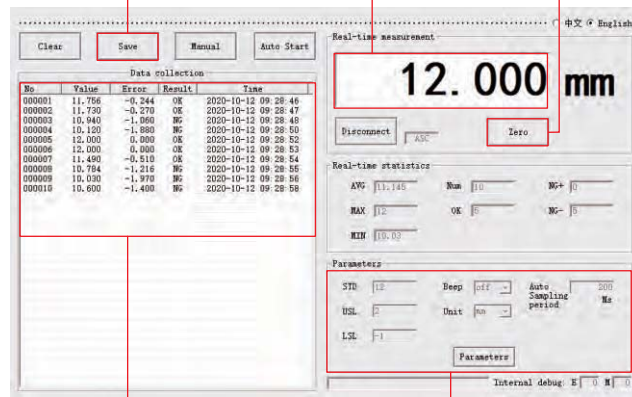
Continuous transmission (can be switched to single transmission)

Code	Description	Plug to product	Plug to computer	Applicable products
7305-40M*	cable for digital indicators (length 2.5m)			   digital indicators
7305-R40M*				

* Supplied with software

Software (included in 7305-40M and 7305-R40M)

- Real-time display
- Tolerance setting, automatic judgment, out-of-tolerance alarm
- Real time statistics: max, min, average, Go/No-Go number
- Data transmission: single transmission with button on cable/foot switch, single transmission operated on computer, continuous transmission operated on computer
- Can save results as EXCEL



Export Excel Real-time display Setting zero of measuring tools

Measurement results and judgment Setting tolerance and sampling period

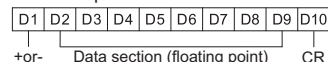
Communication protocol

- Baud: 9600bps
- Data bit: 8
- Stop bit 1
- Check bit: None
- No flow control

Pin definition of RS232 plug:



Data output format

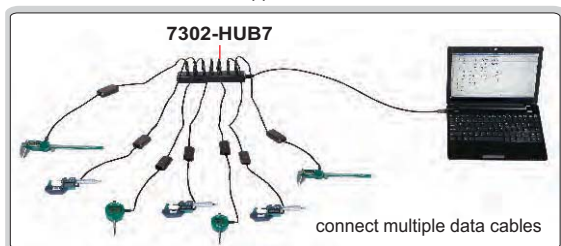


Data format example
 Display Output
 1.234 ➔ +0001.234 ✓
 -1.234 ➔ -0001.234 ✓

Pin No.	Symbol	Description
2	TXD	Data OUT
3	RXD	Data IN
4	VDD	+5V Power
5	GND	Ground

HUBS

application



7302-HUB



7302-HUB7

- Suitable for USB plug data cable

Code	Description	Applicable products
7302-HUB	4-channel hub (length 0.3m, USB computer plug)	7302 series data cables
7302-HUB7	7-channel hub (length 1m, USB computer plug)	7305 series data cables (USB plug)

FOOT SWITCH

- For data transmission



7304-2

Code	Description	Applicable products
7304-2	data transmission foot switch with cable (length 2m)	7302 series data cables 7305 series data cables

application



EXTENSION CABLES

Code	Description	Applicable products
7302-ADD5	Data extension cable (length 5m, USB plug)	7302 series data cables 7305 series data cables (USB plug)
7302-ADD10	Data extension cable (length 10m, USB plug)	



7302-ADD5

application



ADAPTERS FOR DATA OUTPUT CABLE



7323-OTGM



7323-OTGC



7323-OTGC4

- Connect data output cables or wireless receivers to mobile phones, tablet computers (Type-C or Micro-USB interface)
- Data can be transmitted to any app that can receive keyboard signal (such as Excel, WPS, memorandum and other data management softwares)

application

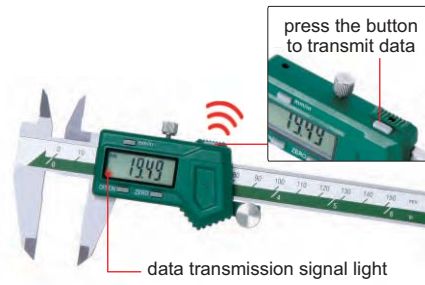
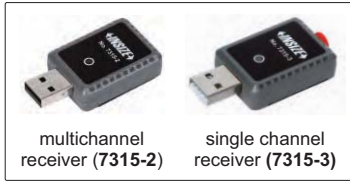


Code	Type	Applicable interface of mobile phones or tablet computers	Plug type	Applicable products
7323-OTGM	One to one	Micro-USB		
7323-OTGC	One to one	Type-C		
7323-OTGC4	One to four	Type-C		

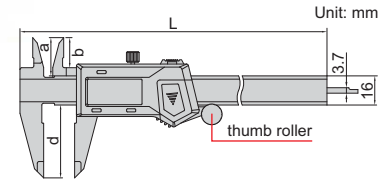
WIRELESS DIGITAL CALIPERS



receiver (optional)

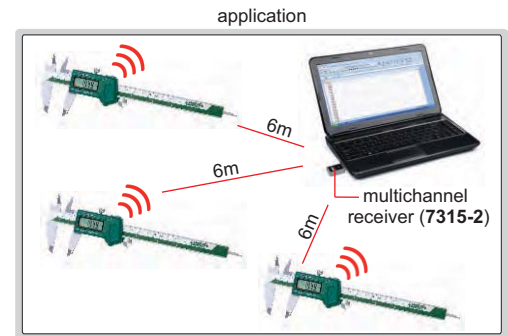


1113-150



- Built-in wireless data transmission module, Zigbee signal
- Transmission distance is 6 meter
- Resolution: 0.01mm/0.0005"
- Buttons: on/off, zero, mm/inch, data transmission
- Automatic power off, move the digital unit to turn on power
- Battery CR2032
- Made of stainless steel
- Optional accessory: receiver (code 7315-2, 7315-3)

Code	Range	Accuracy	Thumb roller	L	a	b	d
1113-150 *	0-150mm/0-6"	±0.03mm	with	236	21	16	40
1113-200 *	0-200mm/0-8"	±0.03mm	with	286	24	19	50
1113-300 *	0-300mm/0-12"	±0.03mm	with	400	25	20.5	60
1113-150W *	0-150mm/0-6"	±0.03mm	without	236	21	16	40
1113-200W *	0-200mm/0-8"	±0.03mm	without	286	24	19	50
1113-300W *	0-300mm/0-12"	±0.03mm	without	400	25	20.5	60



*Supplied with manufacturer inspection certificate traceable to DKD Germany

ATTENTION: IT IS NECESSARY TO SET ZERO AFTER POWER ON EACH TIME

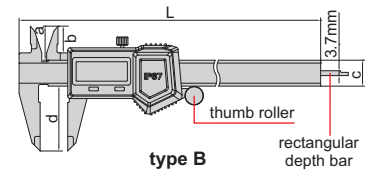
ATTENTION: NO DATA OUTPUT

IP67
WATERPROOF

IP67 WATERPROOF DIGITAL CALIPERS



1118-150B



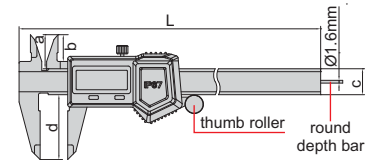
type B

rectangular depth bar

- IP67 dust/waterproof
- Resolution: 0.01mm/0.0005"
- Button function: zero, on/off, mm/inch, ABS/REL, hold
- Battery CR2032
- Meet DIN862
- Made of stainless steel



1118-150R



type R

round depth bar

Code	Range	Accuracy	Thumb roller	Type	L	a	b	c	d
1118-150B *	0-150mm/0-6"	±0.03mm	with	B	236mm	21mm	16mm	16mm	40mm
1118-200B *	0-200mm/0-8"	±0.03mm	with	B	286mm	24mm	19mm	16mm	50mm
1118-300B *	0-300mm/0-12"	±0.03mm	with	B	400mm	25mm	20.5mm	16mm	60mm
1118-150BW *	0-150mm/0-6"	±0.03mm	without	B	236mm	21mm	16mm	16mm	40mm
1118-200BW *	0-200mm/0-8"	±0.03mm	without	B	286mm	24mm	19mm	16mm	50mm
1118-300BW *	0-300mm/0-12"	±0.03mm	without	B	400mm	25mm	20.5mm	16mm	60mm
1118-150R *	0-150mm/0-6"	±0.03mm	with	R	236mm	21mm	16mm	16mm	40mm

*Supplied with manufacturer inspection certificate traceable to DKD Germany

IP67 WATERPROOF DIGITAL CALIPERS

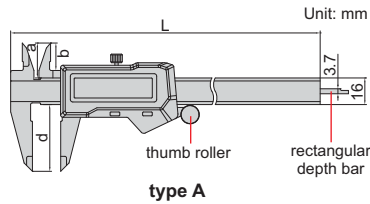
ATTENTION:
NO DATA OUTPUT

IP67
WATERPROOF

INSPECTION
CERTIFICATE
TRACEABLE TO DKD



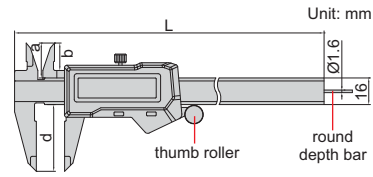
1126-150



type A



1126-150R



type R

- IP67 dust/waterproof
- Resolution: 0.01mm/0.0005"
- Large display
- Button function: zero, on/off, mm/inch
- Battery CR2032
- Automatic power off
- Meet DIN862
- Made of stainless steel

Code	Range	Accuracy	Thumb roller	Type	L	a	b	d
1126-150 *	0-150mm/0-6"	±0.03mm	with	A	234	20	15	40
1126-200 *	0-200mm/0-8"	±0.03mm	with	A	286	24	19	50
1126-300 *	0-300mm/0-12"	±0.03mm	with	A	390	26	21.5	60
1126-150W *	0-150mm/0-6"	±0.03mm	without	A	234	20	15	40
1126-200W *	0-200mm/0-8"	±0.03mm	without	A	286	24	19	50
1126-300W *	0-300mm/0-12"	±0.03mm	without	A	390	26	21.5	60
1126-150R *	0-150mm/0-6"	±0.03mm	with	R	234	20	15	40

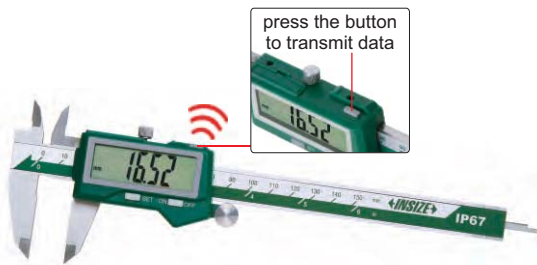
* Supplied with manufacturer inspection certificate traceable to DKD Germany

BUILT-IN BLUETOOTH IP67 WATERPROOF DIGITAL CALIPERS

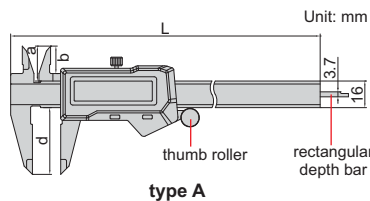
INSPECTION
CERTIFICATE
TRACEABLE TO DKD

BLUETOOTH

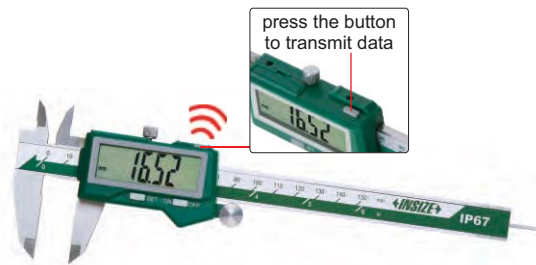
IP67
WATERPROOF



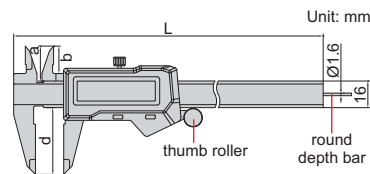
1127-150



type A



1127-150R



type R

- Built-in bluetooth 4.0 wireless transmission module, connect with computers (with bluetooth receiver), mobile phones, tablets, etc., and output keyboard signals. Transmission distance is 10 meters
- IP67 dust/waterproof
- Resolution: 0.01mm/0.0005"
- Large display
- Button function: zero, on/off, mm/inch, data transmission
- Battery CR2032, automatic power off
- Meet DIN862
- Made of stainless steel

Code	Range	Accuracy	Thumb roller	Type	L	a	b	d
1127-150 *	0-150mm/0-6"	±0.03mm	with	A	234	20	15	40
1127-200 *	0-200mm/0-8"	±0.03mm	with	A	286	24	19	50
1127-300 *	0-300mm/0-12"	±0.03mm	with	A	390	26	21.5	60
1127-150W *	0-150mm/0-6"	±0.03mm	without	A	234	20	15	40
1127-200W *	0-200mm/0-8"	±0.03mm	without	A	286	24	19	50
1127-300W *	0-300mm/0-12"	±0.03mm	without	A	390	26	21.5	60
1127-150R *	0-150mm/0-6"	±0.03mm	with	R	234	20	15	40

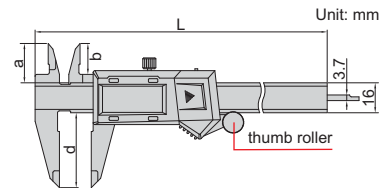
* Supplied with manufacturer inspection certificate traceable to DKD Germany

IP54 WATERPROOF DIGITAL CALIPERS



1104-150

- IP54 dust/waterproof
- Resolution: 0.01mm/0.0005"
- Buttons: on/off, zero, mm/inch, ABS/REL
- Automatic power off
- Battery CR2032
- Data output
- Meet DIN862
- Made of stainless steel
- Optional accessory: wireless transmitter, code **7315-1104**, data output cable (keyboard format), code **7302-1104**



Code	Range	Accuracy	Thumb roller	L	a	b	d
1104-150 *	0-150mm/0-6"	±0.03mm	with	234mm	20mm	15mm	40mm
1104-200 *	0-200mm/0-8"	±0.03mm	with	286mm	24mm	19mm	50mm
1104-300 *	0-300mm/0-12"	±0.03mm	with	390mm	26mm	21.5mm	60mm
1104-150W *	0-150mm/0-6"	±0.03mm	without	234mm	20mm	15mm	40mm
1104-200W *	0-200mm/0-8"	±0.03mm	without	286mm	24mm	19mm	50mm
1104-300W *	0-300mm/0-12"	±0.03mm	without	390mm	26mm	21.5mm	60mm

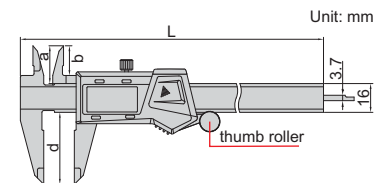
*Supplied with manufacturer inspection certificate traceable to DKD Germany

DIGITAL CALIPERS (ABSOLUTE SYSTEM)



1103-150

- Absolute system, low power consumption, long battery life
- Resolution: 0.01mm/0.0005"
- Buttons: on/off, mm/inch, ORIGIN, ZERO/ABS
- Automatic power off, move the digital unit to turn on power
- Battery CR2032
- Data output
- Meet DIN862
- Made of stainless steel
- Optional accessory: wireless transmitter, code **7315-1103**, data output cable (keyboard format), code **7302-1103**



Code	Range	Accuracy	Thumb roller	L	a	b	d
1103-150 *	0-150mm/0-6"	±0.03mm	with	236mm	21mm	16.5mm	40mm
1103-200 *	0-200mm/0-8"	±0.03mm	with	286mm	24mm	19.5mm	50mm
1103-300 *	0-300mm/0-12"	±0.03mm	with	400mm	26mm	21.5mm	60mm
1103-150W *	0-150mm/0-6"	±0.03mm	without	236mm	21mm	16.5mm	40mm
1103-200W *	0-200mm/0-8"	±0.03mm	without	286mm	24mm	19.5mm	50mm
1103-300W *	0-300mm/0-12"	±0.03mm	without	400mm	26mm	21.5mm	60mm

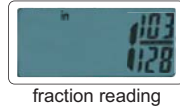
*Supplied with manufacturer inspection certificate

DIGITAL CALIPERS (FRACTION READING)

ATTENTION:
NO DATA OUTPUT

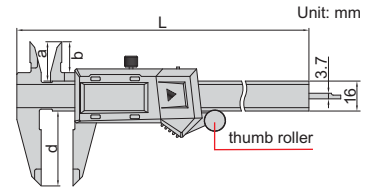
**INSPECTION
CERTIFICATE**
TRACEABLE TO DKD

- Resolution: 0.01mm, 0.0005", 1/128"
- Buttons: unit (mm/in/fraction), ABS, on/off, zero
- Absolute and incremental measurement
- Battery CR2032, automatic power off
- Meet DIN862
- Made of stainless steel



1102-150

Code	Range	Accuracy	Thumb roller	L	a	b	d
1102-150 *	0-150mm/0-6"	±0.03mm	with	234mm	20mm	15mm	40mm
1102-200 *	0-200mm/0-8"	±0.03mm	with	286mm	24mm	19mm	50mm
1102-300 *	0-300mm/0-12"	±0.03mm	with	390mm	26mm	21.5mm	60mm
1102-150W *	0-150mm/0-6"	±0.03mm	without	234mm	20mm	15mm	40mm
1102-200W *	0-200mm/0-8"	±0.03mm	without	286mm	24mm	19mm	50mm
1102-300W *	0-300mm/0-12"	±0.03mm	without	390mm	26mm	21.5mm	60mm



*Supplied with manufacturer inspection certificate traceable to DKD Germany

DIGITAL CALIPERS

ATTENTION:
NO DATA OUTPUT

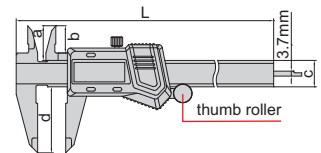
**INSPECTION
CERTIFICATE**
TRACEABLE TO DKD

- Zinc alloy housing for digital unit
- Resolution: 0.01mm/0.0005"
- Buttons: zero, on/off, mm/inch
- Automatic power off, move the digital unit to turn on power
- Battery CR2032
- Meet DIN862
- Made of stainless steel



1114-150A

Code	Range	Accuracy	Thumb roller	L	a	b	c	d
1114-150A *	0-150mm/0-6"	±0.03mm	with	236mm	21mm	16mm	16mm	40mm
1114-200A *	0-200mm/0-8"	±0.03mm	with	286mm	24mm	19mm	16mm	50mm
1114-300A *	0-300mm/0-12"	±0.03mm	with	400mm	25mm	20.5mm	17mm	60mm
1114-150AW *	0-150mm/0-6"	±0.03mm	without	236mm	21mm	16mm	16mm	40mm
1114-200AW *	0-200mm/0-8"	±0.03mm	without	286mm	24mm	19mm	16mm	50mm
1114-300AW *	0-300mm/0-12"	±0.03mm	without	400mm	25mm	20.5mm	17mm	60mm



*Supplied with manufacturer inspection certificate traceable to DKD Germany

DIGITAL CALIPERS (STANDARD TYPE)

DATA
OUTPUT

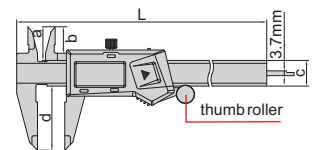
**INSPECTION
CERTIFICATE**
TRACEABLE TO DKD

- Resolution: 0.01mm/0.0005"
- Buttons: on/off, zero, mm/inch
- Automatic power off, move the digital unit to turn on power
- Battery CR2032
- Data output
- Meet DIN862
- Made of stainless steel
- Optional accessory: data output cable (code 7315-21, 7302-21)



1108-150

Code	Range	Accuracy	Thumb roller	L	a	b	c	d
1108-150 *	0-150mm/0-6"	±0.02mm	with	236mm	21mm	16mm	16mm	40mm
1108-200 *	0-200mm/0-8"	±0.03mm	with	286mm	24mm	19mm	16mm	50mm
1108-250 *	0-250mm/0-10"	±0.03mm	with	350mm	25mm	20.5mm	16mm	60mm
1108-300 *	0-300mm/0-12"	±0.03mm	with	400mm	25mm	20.5mm	16mm	60mm
1108-150W *	0-150mm/0-6"	±0.02mm	without	236mm	21mm	16mm	16mm	40mm
1108-200W *	0-200mm/0-8"	±0.03mm	without	286mm	24mm	19mm	16mm	50mm
1108-250W *	0-250mm/0-10"	±0.03mm	without	350mm	25mm	20.5mm	16mm	60mm
1108-300W *	0-300mm/0-12"	±0.03mm	without	400mm	25mm	20.5mm	16mm	60mm



*Supplied with manufacturer inspection certificate traceable to DKD Germany

INSPECTION CERTIFICATE
TRACEABLE TO DKD

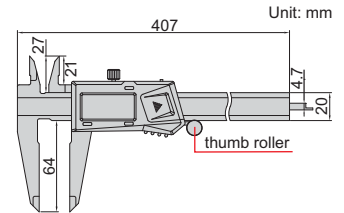
DATA OUTPUT

HEAVY DUTY 300mm DIGITAL CALIPERS

- Resolution: 0.01mm/0.0005"
- Buttons: on/off, zero, mm/inch
- Automatic power off, move the digital unit to turn on power
- Battery CR2032
- Data output
- Meet DIN862
- Made of stainless steel
- Optional accessory: data output cable (code 7315-22, 7302-22)



1196-300



Code	Range	Thumb roller	Accuracy
1196-300 *	0-300mm/0-12"	with	±0.03mm
1196-300W *	0-300mm/0-12"	without	±0.03mm

* Supplied with manufacturer inspection certificate traceable to DKD Germany

INSPECTION CERTIFICATE
TRACEABLE TO DKD

LOCK READING WITH "HOLD" BUTTON

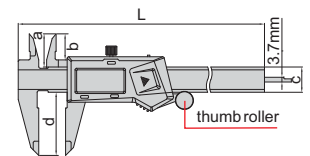
DATA OUTPUT

METRIC DIGITAL CALIPERS

- Resolution: 0.01mm
- Buttons: on/off, zero, hold
- Automatic power off, move the digital unit to turn on power
- Battery CR2032
- Data output
- Meet DIN862
- Made of stainless steel
- Optional accessory: data output cable (code 7315-21, 7302-21)



1109-150



Code	Range	Accuracy	Thumb roller	L	a	b	c	d
1109-150 *	0-150mm	±0.03mm	with	236mm	21mm	16mm	16mm	40mm
1109-200 *	0-200mm	±0.03mm	with	286mm	24mm	19mm	16mm	50mm
1109-300 *	0-300mm	±0.03mm	with	400mm	25mm	20.5mm	16mm	60mm
1109-150W *	0-150mm	±0.03mm	without	236mm	21mm	16mm	16mm	40mm
1109-200W *	0-200mm	±0.03mm	without	286mm	24mm	19mm	16mm	50mm
1109-300W *	0-300mm	±0.03mm	without	400mm	25mm	20.5mm	16mm	60mm

* Supplied with manufacturer inspection certificate traceable to DKD Germany

INSPECTION CERTIFICATE
TRACEABLE TO DKD

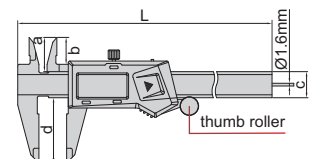
DATA OUTPUT

DIGITAL CALIPERS WITH ROUND DEPTH BAR

- Resolution: 0.01mm/0.0005"
- Buttons: on/off, zero, mm/inch
- Automatic power off, move the digital unit to turn on power
- Battery CR2032
- Meet DIN862
- Made of stainless steel



1119-150



With data interface (data output cable code 7315-21, 7302-21, optional)

Code	Range	Accuracy	Thumb roller	L	a	b	c	d
1119-150 *	0-150mm/0-6"	±0.03mm	with	236mm	21mm	16mm	16mm	40mm
1119-150W *	0-150mm/0-6"	±0.03mm	without	236mm	21mm	16mm	16mm	40mm

Built-in wireless

Code	Range	Accuracy	Thumb roller	L	a	b	c	d
1119-150WL *	0-150mm/0-6"	±0.03mm	with	236mm	21mm	16mm	16mm	40mm
1119-150WWL *	0-150mm/0-6"	±0.03mm	without	236mm	21mm	16mm	16mm	40mm

* Supplied with manufacturer inspection certificate traceable to DKD Germany

LEFT HAND DIGITAL CALIPERS

DATA
OUTPUT

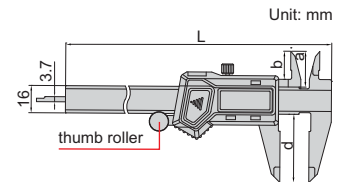
INSPECTION
CERTIFICATE
TRACEABLE TO DKD

- Designed for left handed users
- Resolution: 0.01mm/0.0005"
- Buttons: on/off, zero, mm/inch
- Automatic power off, move the digital unit to turn on power
- Battery CR2032
- Data output
- Meet DIN862
- Made of stainless steel
- Optional accessory: data output cable (code 7315-22, 7302-22)



1130-150

Code	Range	Accuracy	Thumb roller	L	a	b	d
1130-150*	0-150mm/0-6"	±0.03mm	with	236mm	21mm	16mm	40mm
1130-200*	0-200mm/0-8"	±0.03mm	with	286mm	24mm	19mm	50mm
1130-300*	0-300mm/0-12"	±0.03mm	with	400mm	25mm	20.5mm	60mm
1130-150W*	0-150mm/0-6"	±0.03mm	without	236mm	21mm	16mm	40mm
1130-200W*	0-200mm/0-8"	±0.03mm	without	286mm	24mm	19mm	50mm
1130-300W*	0-300mm/0-12"	±0.03mm	without	400mm	25mm	20.5mm	60mm



*Supplied with manufacturer inspection certificate traceable to DKD Germany

DIGITAL CALIPERS WITH CERAMIC TIPPED JAWS

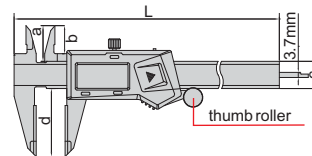
DATA
OUTPUT

INSPECTION
CERTIFICATE
TRACEABLE TO DKD

- Ceramic tipped jaws for outside measurement, extremely wear-resistant, non-magnetic and non electric conductive
- Resolution: 0.01mm/0.0005"
- Buttons: on/off, zero, mm/inch
- Automatic power off, move the digital unit to turn on power
- Battery CR2032, made of stainless steel
- Meet DIN862



1193-150



ceramic
tipped jaws



With data interface (data output cable code 7315-21, 7302-21, optional)

Code	Range	Accuracy	Thumb roller	L	a	b	c	d
1193-150*	0-150mm/0-6"	±0.03mm	with	235mm	21mm	16.5mm	16mm	40mm
1193-200*	0-200mm/0-8"	±0.03mm	with	287mm	24mm	20mm	16mm	50mm
1193-300*	0-300mm/0-12"	±0.03mm	with	390mm	26mm	21.5mm	16mm	60mm
1193-150W*	0-150mm/0-6"	±0.03mm	without	235mm	21mm	16.5mm	16mm	40mm
1193-200W*	0-200mm/0-8"	±0.03mm	without	297mm	24mm	20mm	16mm	50mm
1193-300W*	0-300mm/0-12"	±0.03mm	without	390mm	26mm	21.5mm	16mm	60mm

Built-in wireless

Code	Range	Accuracy	Thumb roller	L	a	b	c	d
1193-150WL*	0-150mm/0-6"	±0.03mm	with	235mm	21mm	16.5mm	16mm	40mm
1193-200WL*	0-200mm/0-8"	±0.03mm	with	287mm	24mm	20mm	16mm	50mm
1193-300WL*	0-300mm/0-12"	±0.03mm	with	390mm	26mm	21.5mm	16mm	60mm
1193-150WWL*	0-150mm/0-6"	±0.03mm	without	235mm	21mm	16.5mm	16mm	40mm
1193-200WWL*	0-200mm/0-8"	±0.03mm	without	297mm	24mm	20mm	16mm	50mm
1193-300WWL*	0-300mm/0-12"	±0.03mm	without	390mm	26mm	21.5mm	16mm	60mm

*Supplied with manufacturer inspection certificate traceable to DKD Germany

DIGITAL CALIPERS WITH CARBIDE TIPPED JAWS



1110-150A

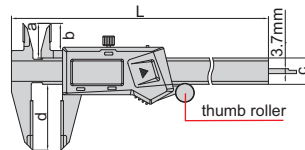


1110-150B



1110-150C

- Resolution: 0.01mm/0.0005"
- Buttons: on/off, zero, mm/inch
- Automatic power off, move the digital unit to turn on power
- Battery CR2032
- Meet DIN862
- Made of stainless steel



No dust/waterproof, with data interface (data output cable code 7315-21, 7302-21, optional)

Code	Range	Accuracy	Thumb roller	L	a	b	c	d	Remark
1110-150A *	0-150mm/0-6"	±0.03mm	with	236mm	21mm	16mm	16mm	40mm	carbide tipped upper and lower jaws
1110-200A *	0-200mm/0-8"	±0.03mm	with	286mm	24mm	19mm	16mm	50mm	carbide tipped upper and lower jaws
1110-300A *	0-300mm/0-12"	±0.03mm	with	400mm	25mm	20.5mm	16mm	60mm	carbide tipped upper and lower jaws
1110-150AW *	0-150mm/0-6"	±0.03mm	without	236mm	21mm	16mm	16mm	40mm	carbide tipped upper and lower jaws
1110-200AW *	0-200mm/0-8"	±0.03mm	without	286mm	24mm	19mm	16mm	50mm	carbide tipped upper and lower jaws
1110-300AW *	0-300mm/0-12"	±0.03mm	without	400mm	25mm	20.5mm	16mm	60mm	carbide tipped upper and lower jaws
1110-150B *	0-150mm/0-6"	±0.03mm	with	236mm	21mm	16mm	16mm	40mm	carbide tipped lower jaws
1110-200B *	0-200mm/0-8"	±0.03mm	with	286mm	24mm	19mm	16mm	50mm	carbide tipped lower jaws
1110-300B *	0-300mm/0-12"	±0.03mm	with	400mm	25mm	20.5mm	16mm	60mm	carbide tipped lower jaws
1110-150BW *	0-150mm/0-6"	±0.03mm	without	236mm	21mm	16mm	16mm	40mm	carbide tipped lower jaws
1110-200BW *	0-200mm/0-8"	±0.03mm	without	286mm	24mm	19mm	16mm	50mm	carbide tipped lower jaws
1110-300BW *	0-300mm/0-12"	±0.03mm	without	400mm	25mm	20.5mm	16mm	60mm	carbide tipped lower jaws

No dust/waterproof, built-in wireless

Code	Range	Accuracy	Thumb roller	L	a	b	c	d	Remark
1110-150AWL *	0-150mm/0-6"	±0.03mm	with	236mm	21mm	16mm	16mm	40mm	carbide tipped upper and lower jaws
1110-200AWL *	0-200mm/0-8"	±0.03mm	with	286mm	24mm	19mm	16mm	50mm	carbide tipped upper and lower jaws
1110-300AWL *	0-300mm/0-12"	±0.03mm	with	400mm	25mm	20.5mm	16mm	60mm	carbide tipped upper and lower jaws
1110-150AWWL *	0-150mm/0-6"	±0.03mm	without	236mm	21mm	16mm	16mm	40mm	carbide tipped upper and lower jaws
1110-200AWWL *	0-200mm/0-8"	±0.03mm	without	286mm	24mm	19mm	16mm	50mm	carbide tipped upper and lower jaws
1110-300AWWL *	0-300mm/0-12"	±0.03mm	without	400mm	25mm	20.5mm	16mm	60mm	carbide tipped upper and lower jaws
1110-150BWL *	0-150mm/0-6"	±0.03mm	with	236mm	21mm	16mm	16mm	40mm	carbide tipped lower jaws
1110-200BWL *	0-200mm/0-8"	±0.03mm	with	286mm	24mm	19mm	16mm	50mm	carbide tipped lower jaws
1110-300BWL *	0-300mm/0-12"	±0.03mm	with	400mm	25mm	20.5mm	16mm	60mm	carbide tipped lower jaws
1110-150BWWL *	0-150mm/0-6"	±0.03mm	without	236mm	21mm	16mm	16mm	40mm	carbide tipped lower jaws
1110-200BWWL *	0-200mm/0-8"	±0.03mm	without	286mm	24mm	19mm	16mm	50mm	carbide tipped lower jaws
1110-300BWWL *	0-300mm/0-12"	±0.03mm	without	400mm	25mm	20.5mm	16mm	60mm	carbide tipped lower jaws

IP67 dust/waterproof, without data interface

Code	Range	Accuracy	Thumb roller	L	a	b	c	d	Remark
1110-150C *	0-150mm/0-6"	±0.03mm	with	236mm	21mm	16mm	16mm	40mm	carbide tipped upper and lower jaws
1110-150D *	0-150mm/0-6"	±0.03mm	with	236mm	21mm	16mm	16mm	40mm	carbide tipped lower jaws
1110-150CW *	0-150mm/0-6"	±0.03mm	without	236mm	21mm	16mm	16mm	40mm	carbide tipped upper and lower jaws
1110-150DW *	0-150mm/0-6"	±0.03mm	without	236mm	21mm	16mm	16mm	40mm	carbide tipped lower jaws

* Supplied with manufacturer inspection certificate traceable to DKD Germany

DIGITAL CALIPERS

DATA OUTPUT

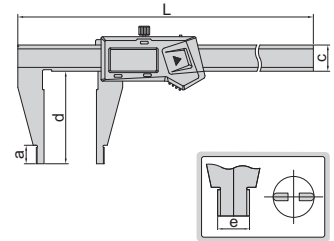
- Resolution: 0.01mm/0.0005"
- Buttons: on/off, zero, mm/inch
- Automatic power off, move the digital unit to turn on power
- Battery CR2032
- Made of stainless steel



1170-300

With data interface (data output cable code 7315-21, 7302-21, optional)

Code	Range	Accuracy	a	c	d	e	L
1170-200	0-200mm/0-8"	±0.03mm	12mm	17mm	60mm	10mm	314mm
1170-306	0-300mm/0-12"	±0.04mm	12mm	17mm	60mm	10mm	420mm
1170-300	0-300mm/0-12"	±0.06mm	12mm	17mm	90mm	10mm	420mm



Built-in wireless

Code	Range	Accuracy	a	c	d	e	L
1170-200WL	0-200mm/0-8"	±0.03mm	12mm	17mm	60mm	10mm	314mm
1170-306WL	0-300mm/0-12"	±0.04mm	12mm	17mm	60mm	10mm	420mm
1170-300WL	0-300mm/0-12"	±0.06mm	12mm	17mm	90mm	10mm	420mm

DIGITAL CALIPERS

DATA OUTPUT

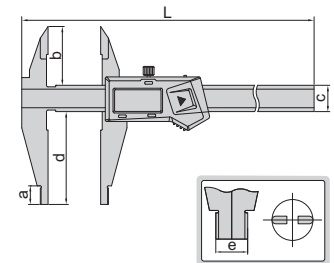
- Resolution: 0.01mm/0.0005"
- Buttons: on/off, zero, mm/inch
- Automatic power off, move the digital unit to turn on power
- Battery CR2032
- Made of stainless steel



1171-300

With data interface (data output cable code 7315-21, 7302-21, optional)

Code	Range	Accuracy	a	b	c	d	e	L
1171-200	0-200mm/0-8"	±0.03mm	12mm	38mm	17mm	60mm	10mm	320mm
1171-250	0-250mm/0-10"	±0.03mm	12mm	38mm	17mm	60mm	10mm	365mm
1171-306	0-300mm/0-12"	±0.04mm	12mm	38mm	17mm	60mm	10mm	420mm
1171-300	0-300mm/0-12"	±0.06mm	12mm	38mm	17mm	90mm	10mm	420mm



Built-in wireless

Code	Range	Accuracy	a	b	c	d	e	L
1171-200WL	0-200mm/0-8"	±0.03mm	12mm	38mm	17mm	60mm	10mm	320mm
1171-250WL	0-250mm/0-10"	±0.03mm	12mm	38mm	17mm	60mm	10mm	365mm
1171-306WL	0-300mm/0-12"	±0.04mm	12mm	38mm	17mm	60mm	10mm	420mm
1171-300WL	0-300mm/0-12"	±0.06mm	12mm	38mm	17mm	90mm	10mm	420mm

MINI DIGITAL CALIPERS

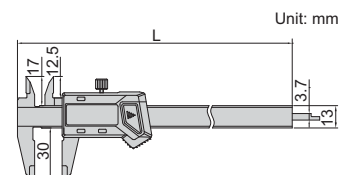
ATTENTION: NO DATA OUTPUT

- Resolution: 0.01mm/0.0005"
- Buttons: zero, mm/inch, on/off
- Automatic power off, move the digital unit to turn on power
- Battery LR44
- Meet DIN862
- Made of stainless steel



1111-100A

Code	Range	Accuracy	L
1111-75A	0-75mm/0-3"	±0.02mm	144mm
1111-100A	0-100mm/0-4"	±0.02mm	170mm



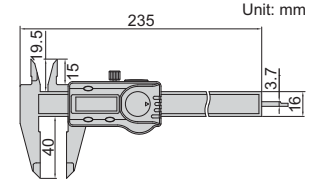
- Made of hard plastic, non-magnetic and non electric conductive
- Prevent workpieces from scratching by calipers
- Resolution: 0.01mm/0.0005"
- Buttons: on/off, zero, mm/inch
- Battery CR2032, automatic power off

ATTENTION:
NO DATA OUTPUT

PLASTIC DIGITAL CALIPER



1139-150



Code	Range	Accuracy
1139-150	0-150mm/0-6"	±0.1mm

DIAL CALIPERS

- Shockproof dial indicator
- Made of stainless steel



1312-150A

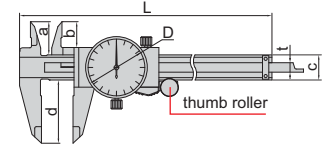
SHOCK PROOF

INSPECTION CERTIFICATE
TRACEABLE TO DKD

Dial indicator graduation: 0.02mm

(mm)

Code	Range	Accuracy	Thumb roller	L	a	b	c	d	D	t
1312-150A *	0-150mm	±0.03mm	with	235	21	16.5	16	40	Ø39	6.5
1312-200A *	0-200mm	±0.03mm	with	288	24	19	16	48	Ø39	6.5
1312-300A *	0-300mm	±0.03mm	with	410	28	22	20	62	Ø44.5	7.5
1312-100AW *	0-100mm	±0.02mm	without	165	18	13	13	30	Ø32	6



Dial indicator graduation: 0.01mm

(mm)

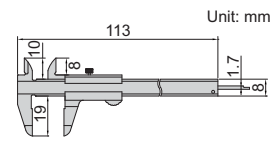
Code	Range	Accuracy	Thumb roller	L	a	b	c	d	D	t
1311-150A *	0-150mm	±0.03mm	with	235	21	16.5	16	40	Ø39	6.5
1311-200A *	0-200mm	±0.03mm	with	288	24	19	16	48	Ø39	6.5
1311-300A *	0-300mm	±0.03mm	with	410	28	22	20	62	Ø44.5	7.5

* Supplied with manufacturer inspection certificate traceable to DKD Germany

MINI VERNIER CALIPERS

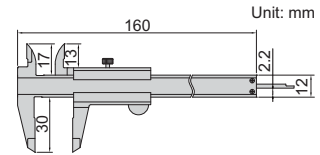
- Meet DIN862
- Made of stainless steel
- Satin chrome plated reading surface

Code	Range	Graduation	Accuracy
1204-70	0-70mm	0.05mm	±0.05mm



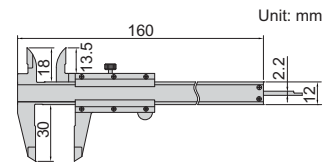
1204-70

Code	Range	Graduation	Accuracy
1203-1003	0-100mm	0.05mm	±0.05mm



1203-1003

Code	Range	Graduation	Accuracy
1201-1003	0-100mm	0.05mm	±0.05mm



1201-1003

VERNIER CALIPERS

Graduation 0.05mm/1/128" (mm)

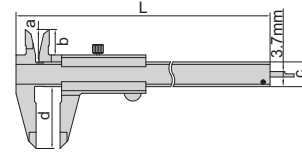
Code	Range	Accuracy	L	a	b	c	d
1205-150S	0-150mm/0-6"	±0.05mm	235	20.5	15.5	16	40
1205-200S	0-200mm/0-8"	±0.05mm	290	23.5	19	17	50
1205-250S	0-250mm/0-10"	±0.05mm	364	27.5	22	20	64
1205-300S	0-300mm/0-12"	±0.05mm	414	27.5	22	20	64



1205-150S

Graduation 0.05mm (mm)

Code	Range	Accuracy	L	a	b	c	d
1205-1503S	0-150mm	±0.05mm	235	20.5	15.5	16	40
1205-2003S	0-200mm	±0.05mm	290	23.5	19	17	50
1205-2503S	0-250mm	±0.05mm	350	26	21.5	16	60
1205-3003S	0-300mm	±0.05mm	414	27.5	22	20	64



Graduation 0.02mm/0.001" (mm)

Code	Range	Accuracy	L	a	b	c	d
1205-1502S	0-150mm/0-6"	±0.03mm	235	20.5	15.5	16	40
1205-2002S	0-200mm/0-8"	±0.03mm	290	23.5	19	17	50
1205-2502S	0-250mm/0-10"	±0.03mm	364	27.5	22	20	64
1205-3002S	0-300mm/0-12"	±0.03mm	414	27.5	22	20	64

Graduation 0.02mm (mm)

Code	Range	Accuracy	L	a	b	c	d
1205-1501S	0-150mm	±0.03mm	235	20.5	15.5	16	40
1205-2001S	0-200mm	±0.03mm	290	23.5	19	17	50
1205-2501S	0-250mm	±0.03mm	350	26	21.5	16	60
1205-3001S	0-300mm	±0.03mm	414	27.5	22	20	64

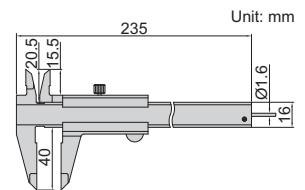
- Meet DIN862
- Made of stainless steel
- Satin chrome plated reading surface

VERNIER CALIPER WITH ROUND DEPTH BAR

- Graduation 0.05mm/1/128"
- Round depth bar
- Meet DIN862
- Made of stainless steel
- Satin chrome plated reading surface



1202-150



Code	Range	Accuracy
1202-150	0-150mm/0-6"	±0.05mm

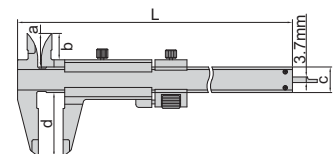
VERNIER CALIPERS WITH FINE ADJUSTMENT

- Graduation 0.02mm/0.001"
- With fine adjustment
- Meet DIN862
- Made of stainless steel
- Satin chrome plated reading surface



1233-130

Code	Range	Accuracy	L	a	b	c	d
1233-130	0-130mm/0-5"	±0.03mm	230	20.5	16.5	16	40
1233-180	0-180mm/0-7"	±0.03mm	295	23.5	19	16	50
1233-280	0-280mm/0-11"	±0.03mm	410	26	20	20	60



VERNIER CALIPERS WITH THUMB CLAMP

- Meet DIN862
- With thumb clamp
- Made of stainless steel
- Satin chrome plated reading surface

Graduation 0.05mm/1/128" (mm)

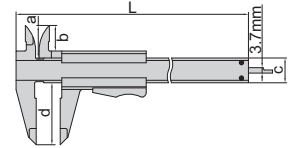
Code	Range	Accuracy	L	a	b	c	d
1223-150	0-150mm/0-6"	±0.05mm	230	20.5	16.5	16	40
1223-200	0-200mm/0-8"	±0.05mm	295	23.5	19	16	50

Graduation 0.02mm/0.001" (mm)

Code	Range	Accuracy	L	a	b	c	d
1223-1502	0-150mm/0-6"	±0.03mm	230	20.5	16.5	16	40
1223-2002	0-200mm/0-8"	±0.03mm	295	23.5	19	16	50



1223-150



VERNIER CALIPERS WITH CARBIDE TIPPED JAWS

- Carbide tipped jaws for inside and outside measurements
- Meet DIN862
- Made of stainless steel
- Satin chrome plated reading surface

Graduation 0.05mm/1/128" (mm)

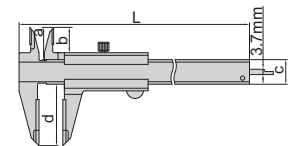
Code	Range	Accuracy	L	a	b	c	d
1238-150	0-150mm/0-6"	±0.05mm	230	21	16.5	16	40
1238-200	0-200mm/0-8"	±0.05mm	295	24	19	16	50
1238-300	0-300mm/0-12"	±0.05mm	410	25	20	17	60

Graduation 0.02mm/0.001" (mm)

Code	Range	Accuracy	L	a	b	c	d
1238-1502	0-150mm/0-6"	±0.03mm	230	21	16.5	16	40
1238-2002	0-200mm/0-8"	±0.03mm	295	24	19	16	50
1238-3002	0-300mm/0-12"	±0.03mm	410	25	20	17	60



1238-150



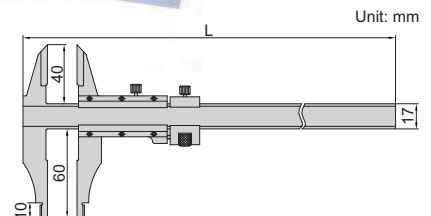
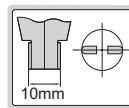
VERNIER CALIPERS

- With fine adjustment
- Made of stainless steel
- Satin chrome plated reading surface



1217-3001

Code	Range	Graduation	Accuracy	L
1217-2503	0-250mm	0.05mm	±0.05mm	360mm
1217-3001	0-300mm	0.02mm	±0.03mm	410mm

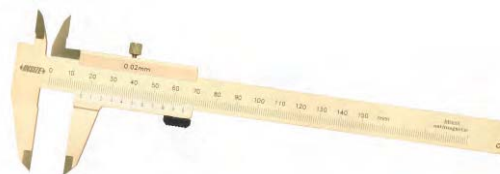


ATTENTION:
NOT HARDENED

PURE COPPER

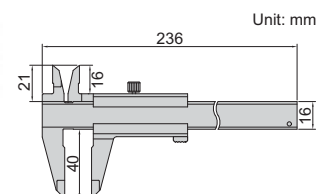
- Suitable for magnetic parts
- Made of pure copper

VERNIER CALIPERS (ANTI MAGNETIC)



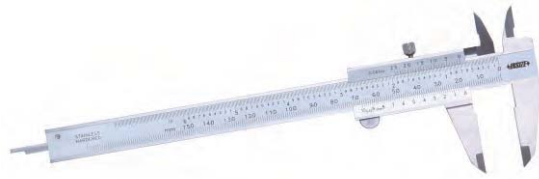
1224-150A

Code	Range	Graduation	Accuracy
1224-150A	0-150mm	0.02mm	±0.05mm
1224-1501A	0-150mm	0.05mm	±0.05mm

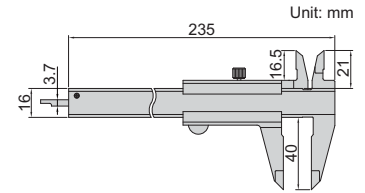


LEFT HAND VERNIER CALIPERS

- Designed for left handed users
- Made of stainless steel
- Satin chrome plated reading surface



1239-1502



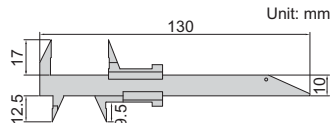
Code	Range	Graduation	Accuracy
1239-150	0-150mm/0-6"	0.05mm/1/128"	±0.05mm
1239-1503	0-150mm	0.05mm	±0.05mm
1239-1502	0-150mm/0-6"	0.02mm/0.001"	±0.03mm
1239-1501	0-150mm	0.02mm	±0.03mm

TEETH VERNIER CALIPER

- Used for teeth
- Made of stainless steel



1226-70



scale on the back



Code	Range	Graduation	Accuracy
1226-70	0-70mm	0.1mm	±0.1mm

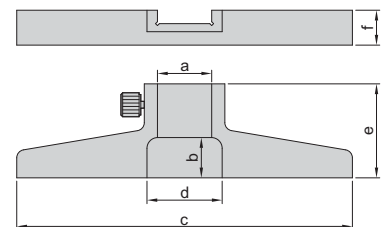
DEPTH BASE ATTACHMENTS



6140



6140-16B



- To increase the stability of depth measurement
- Suitable for digital calipers and dial calipers
- Made of stainless steel



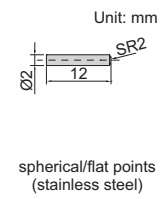
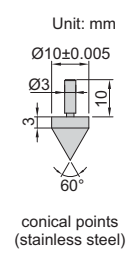
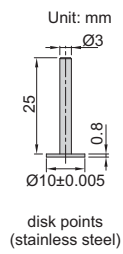
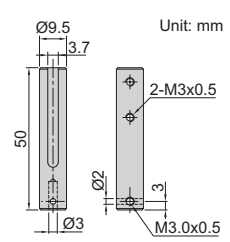
(mm)

Code	a	b	c	d	e	f	Type	Application
6140	16.5	9	75	18	30	6	narrow base (f=6)	Suitable for calipers with beam width (w) 16mm
6140-300A	20	15	125	22	34	9	narrow base (f=9)	Suitable for calipers with beam width (w) 20mm
6140-16B	16	12.5	75	24.5	30	11	wide base (f=11), high stability	Suitable for calipers with beam width (w) 16mm
6140-300B	20	15	125	28	35	13	wide base (f=13), high stability	Suitable for calipers with beam width (w) 20mm

ACCESSORY SET FOR DIGITAL CALIPERS CODE 6144



6144



- Suitable for 0-150mm/0-6" and 0-200mm/0-8" digital calipers (thickness of lower jaws ≤ 3.7mm)

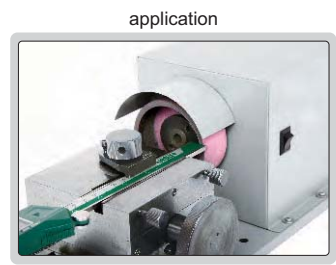
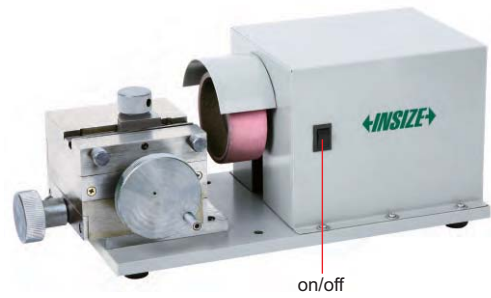
Code
6144

<p>16-20mm</p>	<p>measuring external groove diameter (h1 ≤ 3.5mm)</p>		<p>measuring internal groove diameter (h2 ≤ 3.5mm)</p>		<p>measuring center distance</p>
<p>0-6mm</p>	<p>spherical points for groove diameter (inside hole) measurement</p>	<p>0-6mm</p>	<p>flat points for external groove diameter measurement</p>		

CALIPER END GRINDING MACHINE CODE 6309



- Used for grinding the depth measuring surface of the end of calipers



SPECIFICATION

Power supply	220V, 50/60Hz
Dimension (L×W×H)	370×200×160mm
Weight	15kg

DIGITAL CALIPERS

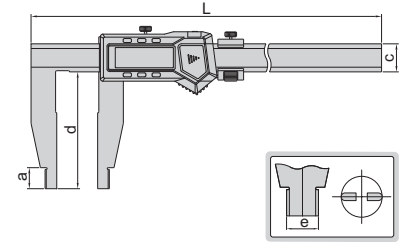
DATA OUTPUT



With data interface
(data output cable code 7315-22, 7302-22, optional, for calipers with c=24mm or 31mm)

1106-501

Code	Range	Accuracy	a	c	d	e	L
1106-301	0-300mm/0-12"	±0.05mm	18mm	24mm	100mm	20mm	420mm
1106-302	0-300mm/0-12"	±0.05mm	18mm	24mm	150mm	20mm	420mm
1106-451	0-450mm/0-18"	±0.05mm	18mm	24mm	100mm	20mm	625mm
1106-501	0-500mm/0-20"	±0.05mm	18mm	24mm	100mm	20mm	675mm
1106-502	0-500mm/0-20"	±0.06mm	18mm	24mm	150mm	20mm	675mm
1106-503	0-500mm/0-20"	±0.06mm	24mm	31mm	200mm	20mm	675mm
1106-505	0-500mm/0-20"	±0.08mm	24mm	42mm	300mm	20mm	675mm
1106-601	0-600mm/0-24"	±0.05mm	18mm	24mm	100mm	20mm	770mm
1106-602	0-600mm/0-24"	±0.06mm	18mm	24mm	150mm	20mm	770mm
1106-603	0-600mm/0-24"	±0.06mm	24mm	31mm	200mm	20mm	770mm
1106-802	0-800mm/0-32"	±0.07mm	24mm	31mm	150mm	20mm	1025mm
1106-1002	0-1000mm/0-40"	±0.08mm	24mm	31mm	150mm	20mm	1220mm
1106-1003	0-1000mm/0-40"	±0.08mm	24mm	31mm	200mm	20mm	1220mm
1106-1005	0-1000mm/0-40"	±0.10mm	24mm	42mm	300mm	20mm	1220mm
1106-1502	0-1500mm/0-60"	±0.11mm	24mm	42mm	150mm	20mm	1780mm
1106-1503	0-1500mm/0-60"	±0.12mm	24mm	42mm	200mm	20mm	1780mm
1106-2002	0-2000mm/0-80"	±0.14mm	24mm	42mm	150mm	20mm	2290mm
1106-2003	0-2000mm/0-80"	±0.14mm	24mm	42mm	200mm	20mm	2290mm
1106-2502	0-2500mm/0-100"	±0.22mm	24mm	42mm	150mm	20mm	2800mm
1106-3002	0-3000mm/0-120"	±0.26mm	24mm	42mm	150mm	20mm	3300mm



- Resolution: 0.01mm/0.0005"
- Button function: on/off, zero, mm/inch, ABS, data preset
- Battery CR2032
- Made of stainless steel

Built-in wireless

Code	Range	Accuracy	a	c	d	e	L
1106-301WL	0-300mm/0-12"	±0.05mm	18mm	24mm	100mm	20mm	420mm
1106-302WL	0-300mm/0-12"	±0.05mm	18mm	24mm	150mm	20mm	420mm
1106-451WL	0-450mm/0-18"	±0.05mm	18mm	24mm	100mm	20mm	625mm
1106-501WL	0-500mm/0-20"	±0.05mm	18mm	24mm	100mm	20mm	675mm
1106-502WL	0-500mm/0-20"	±0.06mm	18mm	24mm	150mm	20mm	675mm
1106-601WL	0-600mm/0-24"	±0.05mm	18mm	24mm	100mm	20mm	770mm
1106-602WL	0-600mm/0-24"	±0.06mm	18mm	24mm	150mm	20mm	770mm

DIGITAL CALIPERS

- Resolution: 0.01mm/0.0005"
- Button function: on/off, zero, mm/inch, ABS, data preset
- Battery CR2032
- Made of stainless steel

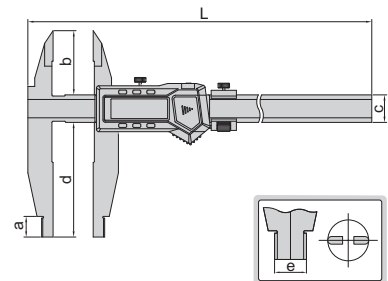


DATA OUTPUT

1117-501

With data interface (data output cable code 7315-22, 7302-22, optional)

Code	Range	Accuracy	a	b	c	d	e	L
1117-301	0-300mm/0-12"	±0.05mm	18mm	56mm	24mm	100mm	20mm	420mm
1117-501	0-500mm/0-20"	±0.05mm	18mm	56mm	24mm	100mm	20mm	675mm
1117-502	0-500mm/0-20"	±0.06mm	18mm	56mm	24mm	150mm	20mm	675mm
1117-601	0-600mm/0-24"	±0.05mm	18mm	56mm	24mm	100mm	20mm	770mm
1117-802	0-800mm/0-32"	±0.07mm	24mm	67mm	31mm	150mm	20mm	1025mm
1117-1002	0-1000mm/0-40"	±0.08mm	24mm	67mm	31mm	150mm	20mm	1220mm



Built-in wireless

Code	Range	Accuracy	a	b	c	d	e	L
1117-301WL	0-300mm/0-12"	±0.05mm	18mm	56mm	24mm	100mm	20mm	420mm
1117-501WL	0-500mm/0-20"	±0.05mm	18mm	56mm	24mm	100mm	20mm	675mm
1117-502WL	0-500mm/0-20"	±0.06mm	18mm	56mm	24mm	150mm	20mm	675mm
1117-601WL	0-600mm/0-24"	±0.05mm	18mm	56mm	24mm	100mm	20mm	770mm

DIGITAL CALIPERS

DATA OUTPUT

2

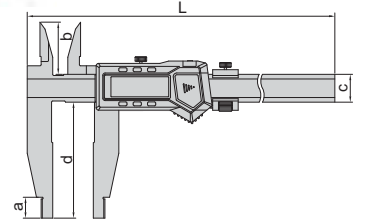
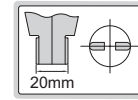
- Resolution: 0.01mm/0.0005"
- Button function: on/off, zero, mm/inch, ABS, data preset
- Battery CR2032
- Made of stainless steel



1136-501

With data interface (data output cable code 7315-22, 7302-22, optional, for calipers with c=24mm or 31mm) (mm)

Code	Range	Accuracy	a	b	c	d	L
1136-301	0-300mm/0-12"	±0.05mm	18	45	24	100	420
1136-451	0-450mm/0-18"	±0.05mm	18	45	24	100	625
1136-501	0-500mm/0-20"	±0.05mm	18	45	24	100	675
1136-502	0-500mm/0-20"	±0.06mm	18	45	24	150	675
1136-503	0-500mm/0-20"	±0.06mm	24	60	31	200	675
1136-601	0-600mm/0-24"	±0.05mm	18	45	24	100	770
1136-1002	0-1000mm/0-40"	±0.08mm	24	60	31	150	1220
1136-1502	0-1500mm/0-60"	±0.11mm	24	60	42	150	1780
1136-2002	0-2000mm/0-80"	±0.14mm	24	60	42	150	2290

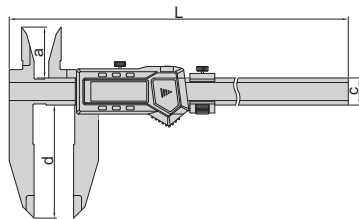


Built-in wireless (mm)

Code	Range	Accuracy	a	b	c	d	L
1136-301WL	0-300mm/0-12"	±0.05mm	18	45	24	100	420
1136-451WL	0-450mm/0-18"	±0.05mm	18	45	24	100	625
1136-501WL	0-500mm/0-20"	±0.05mm	18	45	24	100	675
1136-502WL	0-500mm/0-20"	±0.06mm	18	45	24	150	675
1136-601WL	0-600mm/0-24"	±0.05mm	18	45	24	100	770

DIGITAL CALIPERS

DATA OUTPUT



1135-601

With data interface (data output cable code 7315-22, 7302-22, optional) (mm)

Code	Range	Accuracy	a	c	d	L
1135-451	0-450mm/0-18"	±0.05mm	45	24	100	625
1135-601	0-600mm/0-24"	±0.05mm	45	24	100	770
1135-1002	0-1000mm/0-40"	±0.08mm	60	31	150	1220

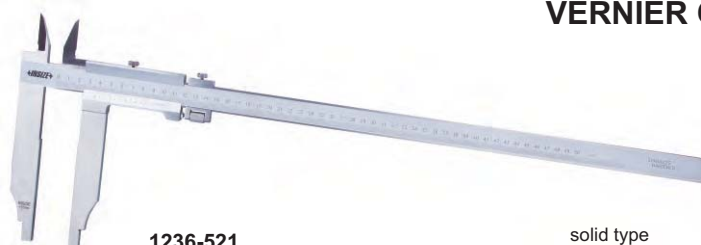
- Resolution: 0.01mm/0.0005"
- Button function: on/off, zero, mm/inch, ABS, data preset
- Battery CR2032
- Made of stainless steel

Built-in wireless (mm)

Code	Range	Accuracy	a	c	d	L
1135-451WL	0-450mm/0-18"	±0.05mm	45	24	100	625
1135-601WL	0-600mm/0-24"	±0.05mm	45	24	100	770

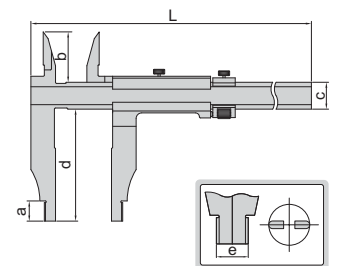
VERNIER CALIPERS (SOLID TYPE)

- With fine adjustment
- Made of stainless steel
- Satin chrome plated reading surface



1236-521

solid type (without screw)



Graduation 0.05mm/1/128" (mm)

Code	Range	Accuracy	a	b	c	d	e	L
1236-394	0-300mm/0-12"	±0.07mm	12	38	20	90	10	450
1236-514	0-500mm/0-20"	±0.07mm	18	45	24	100	20	670
1236-524	0-500mm/0-20"	±0.08mm	18	45	24	150	20	670
1236-614	0-600mm/0-24"	±0.08mm	18	45	24	100	20	770
1236-824	0-800mm/0-32"	±0.09mm	24	60	31	150	20	1030
1236-1024	0-1000mm/0-40"	±0.12mm	24	60	31	150	20	1230

Graduation 0.02mm (mm)

Code	Range	Accuracy	a	b	c	d	e	L
1236-511	0-500mm	±0.05mm	18	45	24	100	20	670
1236-521	0-500mm	±0.06mm	18	45	24	150	20	670
1236-1021	0-1000mm	±0.08mm	24	60	31	150	20	1230

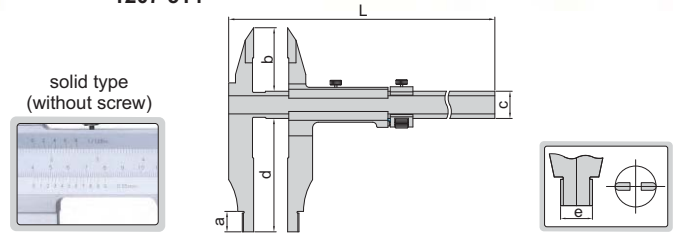
VERNIER CALIPERS (SOLID TYPE)

- Graduation 0.05mm/1/128"
- With fine adjustment
- Made of stainless steel
- Satin chrome plated reading surface



1207-514

Code	Range	Accuracy	a	b	c	d	e	L
1207-394	0-300mm/0-12"	±0.07mm	12	40	20	90	10	440
1207-514	0-500mm/0-20"	±0.07mm	18	56	24	100	20	670
1207-524	0-500mm/0-20"	±0.08mm	18	56	24	150	20	670
1207-824	0-800mm/0-32"	±0.09mm	24	67	31	150	20	930
1207-1024	0-1000mm/0-40"	±0.12mm	24	67	31	150	20	1230



solid type
(without screw)

VERNIER CALIPERS (SOLID TYPE)

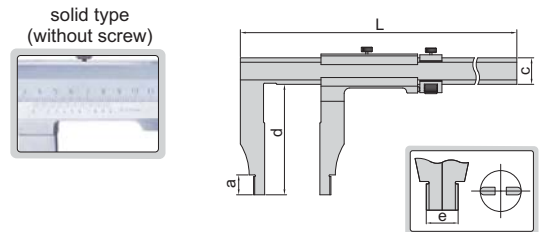


1208-511

Graduation 0.05mm/1/128"

Code	Range	Accuracy	a	c	d	e	L
1208-214	0-200mm/0-8"	±0.06mm	10	20	100	10	330
1208-394	0-300mm/0-12"	±0.07mm	10	20	90	10	410
1208-324	0-300mm/0-12"	±0.07mm	18	24	150	20	410
1208-524	0-500mm/0-20"	±0.08mm	18	24	150	20	670
1208-614	0-600mm/0-24"	±0.08mm	18	24	100	20	770
1208-624	0-600mm/0-24"	±0.09mm	18	24	150	20	770
1208-824	0-800mm/0-32"	±0.09mm	24	31	150	20	1030
1208-1024	0-1000mm/0-40"	±0.12mm	24	31	150	20	1230
1208-1524	0-1500mm/0-60"	±0.16mm	24	42	150	20	1820
1208-2024	0-2000mm/0-80"	±0.20mm	24	42	150	20	2330

- With fine adjustment
- Made of stainless steel
- Satin chrome plated reading surface



solid type
(without screw)

Graduation 0.02mm

Code	Range	Accuracy	a	c	d	e	L
1208-511	0-500mm	±0.05mm	18	24	100	20	670
1208-521	0-500mm	±0.06mm	18	24	150	20	670
1208-1021	0-1000mm	±0.08mm	24	31	150	20	1230
1208-1521	0-1500mm	±0.11mm	24	42	150	20	1820

VERNIER CALIPERS (SOLID TYPE)

- With fine adjustment
- Made of stainless steel
- Satin chrome plated reading surface



1210-611

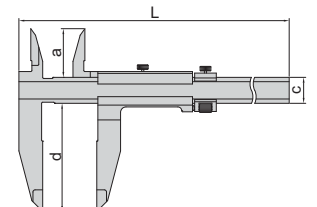
Graduation 0.05mm/1/128"

Code	Range	Accuracy	a	c	d	L
1210-614	0-600mm/0-24"	±0.08mm	45	24	100	770
1210-1024	0-1000mm/0-40"	±0.12mm	60	31	150	1230

Graduation 0.02mm

Code	Range	Accuracy	a	c	d	L
1210-611	0-600mm	±0.05mm	45	24	100	770
1210-1021	0-1000mm	±0.08mm	60	31	150	1230

solid type
(without screw)



VERNIER CALIPERS (SEPARATE TYPE)

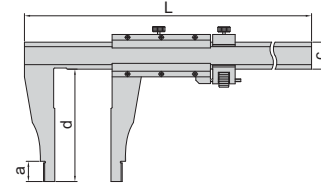
- With fine adjustment
- Made of stainless steel
- Satin chrome plated reading surface



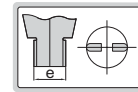
1214-500

Graduation 0.02mm/0.001" (mm)

Code	Range	Accuracy	a	c	d	e	L
1214-300	0-300mm/0-12"	±0.05mm	10	20	75	10	410
1214-450	0-450mm/0-18"	±0.05mm	18	24	100	20	620
1214-500	0-500mm/0-20"	±0.05mm	18	24	100	20	670
1214-600	0-600mm/0-24"	±0.05mm	18	24	100	20	770
1214-1000	0-1000mm/0-40"	±0.08mm	24	32	140	20	1216
1214-1500	0-1500mm/0-60"	±0.12mm	24	42	200	20	1830
1214-2000	0-2000mm/0-80"	±0.14mm	24	42	200	20	2320



separate type
(with screws)



Graduation 0.05mm/1/128" (mm)

Code	Range	Accuracy	a	c	d	e	L
1214-6004	0-600mm/0-24"	±0.08mm	18	24	100	20	770
1214-1004	0-1000mm/0-40"	±0.12mm	24	32	140	20	1216

LONG JAW VERNIER CALIPERS (SEPARATE TYPE)

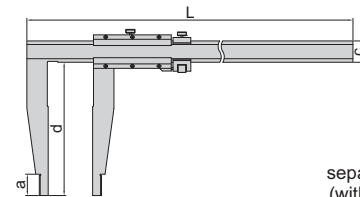
- With fine adjustment
- Made of stainless steel
- Satin chrome plated reading surface



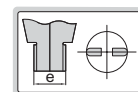
1215-1032

Graduation 0.02mm/0.001" (mm)

Code	Range	Accuracy	a	c	d	e	L
1215-392	0-300mm/0-12"	±0.05mm	10	17	90	10	410
1215-322	0-300mm/0-12"	±0.05mm	18	24	150	20	470
1215-522	0-500mm/0-20"	±0.06mm	18	24	150	20	670
1215-532	0-500mm/0-20"	±0.06mm	18	24	200	20	670
1215-622	0-600mm/0-24"	±0.06mm	18	24	150	20	770
1215-642	0-600mm/0-24"	±0.08mm	24	32	250	20	870
1215-822	0-800mm/0-32"	±0.07mm	24	32	150	20	1020
1215-832	0-800mm/0-32"	±0.07mm	24	32	200	20	1020
1215-1032	0-1000mm/0-40"	±0.08mm	24	32	200	20	1220
1215-1052	0-1000mm/0-40"	±0.11mm	24	42	300	20	1330
1215-3052	0-3000mm/0-120"	±0.26mm	24	50	300	20	3360



separate type
(with screws)



Graduation 0.05mm/1/128" (mm)

Code	Range	Accuracy	a	c	d	e	L
1215-524	0-500mm/0-20"	±0.08mm	18	24	150	20	670
1215-1034	0-1000mm/0-40"	±0.12mm	24	32	200	20	1330

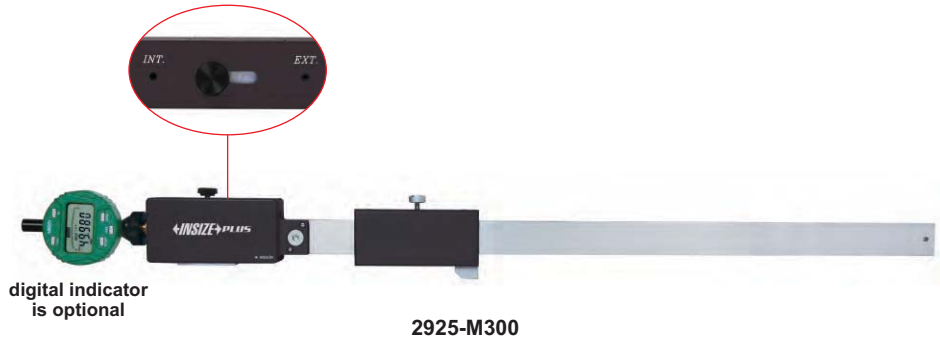
UNIVERSAL COMPARISON GAGES

INSIZE PLUS
MADE IN EUROPE



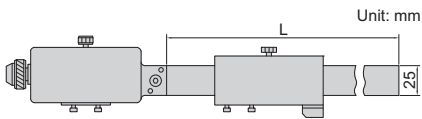
2

internal and external measurement switch



digital indicator is optional

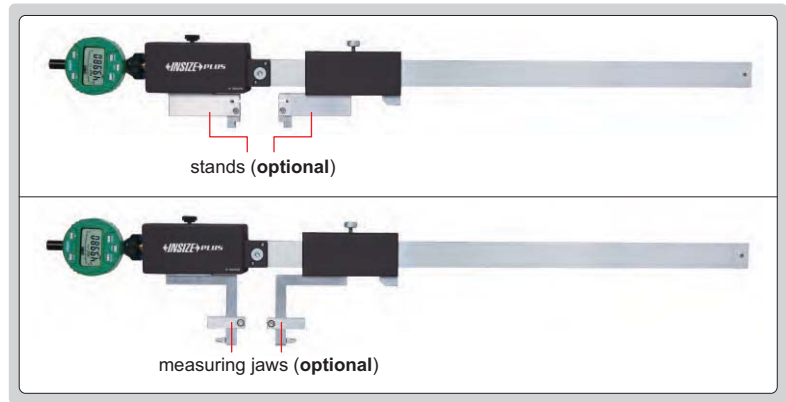
2925-M300



Unit: mm

- For measuring external diameter, internal diameter, center distance, etc.
- Moving range of probe: 10mm, effective measuring range: ± 2 mm
- Optional accessory: cylinder gage blocks (4001 series), gage block accessories (6881 series), gage block holder (6886 series)

working with stands or measuring jaws



stands (optional)

measuring jaws (optional)

Code	External range	Internal range	L	Repeatability*	Accuracy*
2925-M300	0-300mm/0-12"	25-300mm/1"-12"	400mm	2 μ m	5 μ m
2925-M500	0-500mm/0-20"	25-500mm/1"-20"	620mm	2 μ m	5 μ m
2925-M1000	0-1000mm/0-40"	25-1000mm/1"-40"	1150mm	2 μ m	5 μ m

* Repeatability and accuracy are assured within the effective range of ± 2 mm after zero setting

Digital indicator (optional)



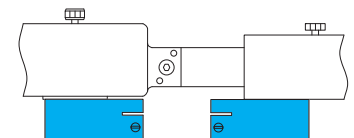
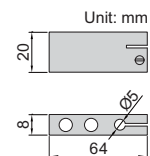
Resolution: 0.001mm/0.00005"

Code	Range
2103-10F	12.7mm/0.5"

Stands (optional, supplied in pair)



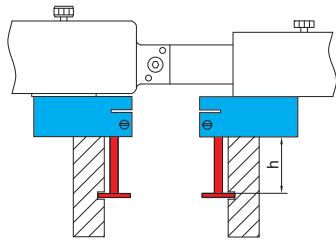
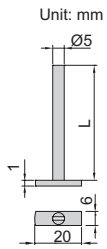
Code
2925-C



To be continued

Continued from previous page

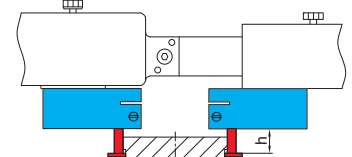
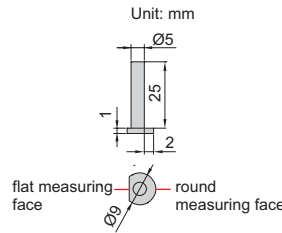
Rectangular points (optional, supplied in pair)



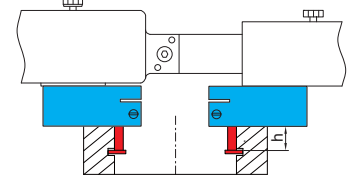
Measuring the distance between two parallel planes (2925-P101 depth h<12mm) (2925-P102 depth h<45mm)

Code	L (mm)
2925-P101	25
2925-P102	60

Disk points (optional, supplied in pair)



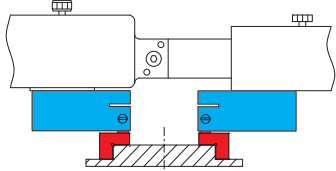
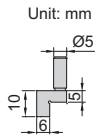
Measuring external groove diameter with flat measuring face (depth h≤10mm)



Measuring internal groove diameter with round measuring face (depth h≤10mm)

Code
2925-S101

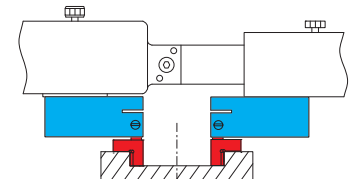
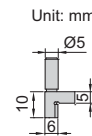
Flat shoulder points (optional, supplied in pair)



Measuring outside diameter of shallow steps

Code
2925-J101

Round shoulder points (optional, supplied in pair)



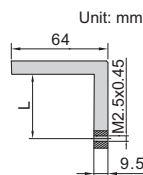
Measuring inside diameter of shallow holes

Code
2925-J201

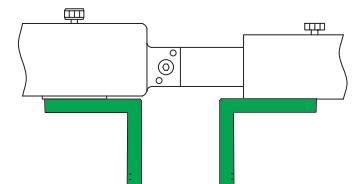
Measuring jaws (optional, supplied in pair)



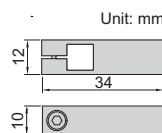
2925-Z50



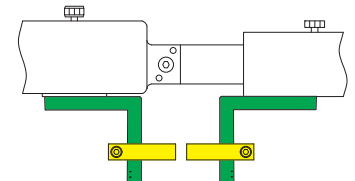
Code	Length (L)
2925-Z25	25mm
2925-Z50	50mm
2925-Z100	100mm



Depth stops (optional, supplied in pair)

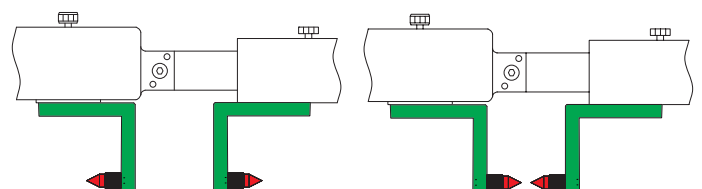
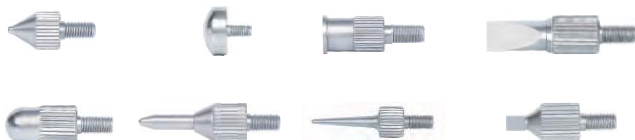


Code
2925-H



Points (optional, supplied in single)

Refer to page (146~148)



To be continued

Continued from previous page

2

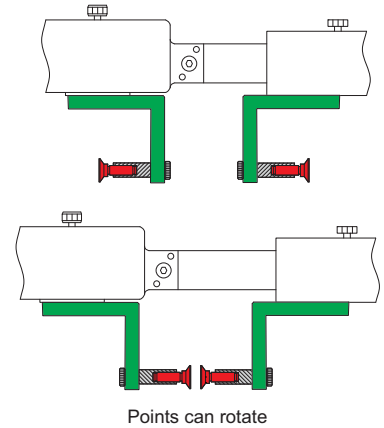
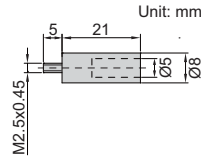
Multifunctional points 7392* (optional, supplied in pair)
refer to 1526-200 for more details



* It is necessary to use point sleeves (code 2923-T101) for these points

Point sleeves
(optional, supplied in pair)

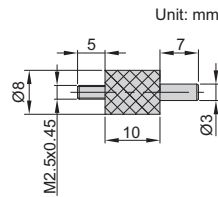
Code
2923-T101



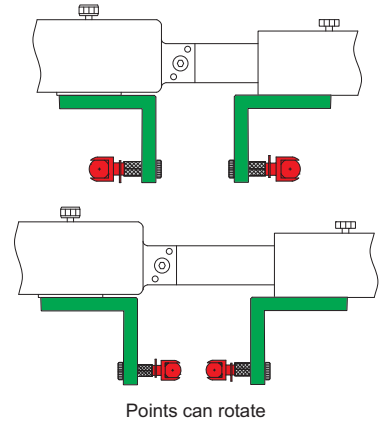
Ball points 7383* (optional, supplied in pair)
Refer to page 117



Point sleeves
(optional, supplied in pair)
Code
2923-T201



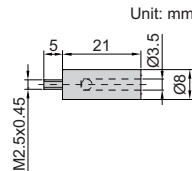
* It is necessary to use point sleeves (code 2923-T201) for these points



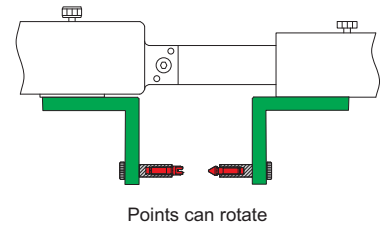
Measuring points for external screw thread micrometers 7384* (optional, supplied in pair)
Refer to page 71



Point sleeves
(optional, supplied in pair)
Code
2923-T301



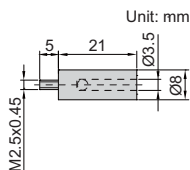
* It is necessary to use point sleeves (code 2923-T301) for these points



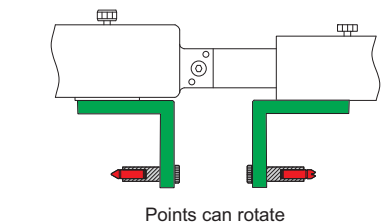
Measuring points for internal screw thread micrometers 7385* (optional, supplied in pair)
Refer to page 118



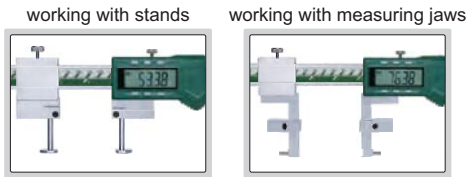
Point sleeves
(optional, supplied in pair)
Code
2923-T301



* It is necessary to use point sleeves (code 2923-T301) for these points



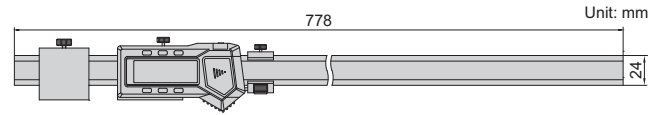
UNIVERSAL CALIPERS



1125-600

- Buttons: on/off, set, mm/inch, ABS, preset (+, -)
- Automatic power off, move the digital unit to turn on power
- Battery CR2032
- Made of stainless steel

DATA OUTPUT



With data interface (data output cable code 7315-22, 7302-22, optional)

Code	Range *	Resolution	Accuracy
1125-600	0-600mm/0-24"	0.01mm/0.0005"	±0.05mm



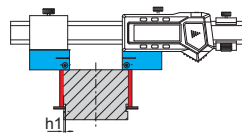
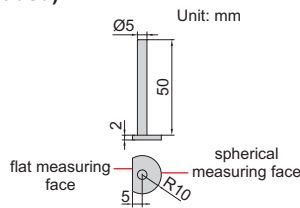
VIDEO

Built-in wireless

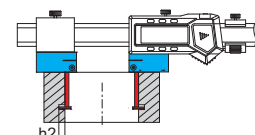
Code	Range *	Resolution	Accuracy
1125-600WL	0-600mm/0-24"	0.01mm/0.0005"	±0.05mm

*The range changes according to different points

Half disk points (included)

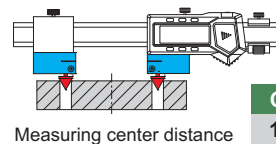
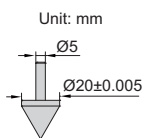


Measuring external groove diameter with flat measuring face (depth $h1 \leq 2.5\text{mm}$)



Measuring internal groove diameter with spherical measuring face (depth $h2 \leq 7.5\text{mm}$)

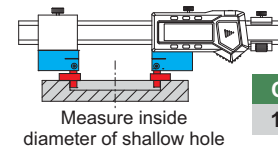
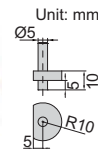
Conical points (optional)



Measuring center distance

Code
1125-T101

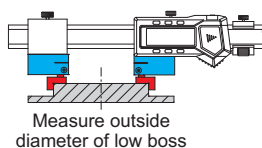
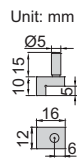
Round shoulder points (optional)



Measure inside diameter of shallow hole

Code
1125-T102

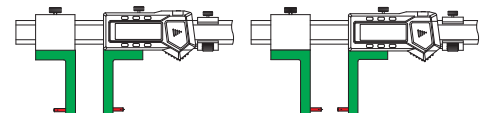
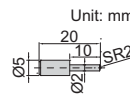
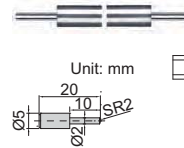
Flat shoulder points (optional)



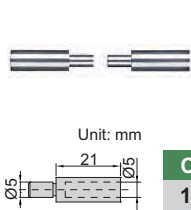
Measure outside diameter of low boss

Code
1125-T103

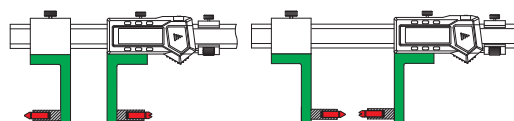
Spherical points (included)



Point sleeve (optional)

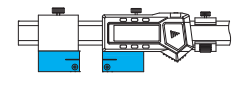
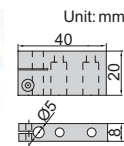


Code
1125-T104

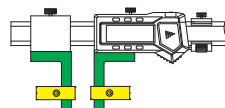
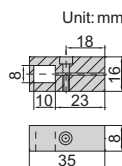


Working with multifunctional points, ball points and screw thread points

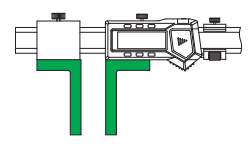
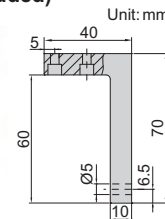
Stands (included)



Depth stop (included)



Measuring jaws (included)



Multifunctional points 7392* (optional, next page)



Ball points 7391* (optional, next page)



Screw thread points 7381*, 7321* (optional, next page)

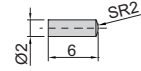


* It is necessary to use point sleeve (code 1526-T101) for these points

DIGITAL CALIPER WITH INTERCHANGEABLE POINTS CODE 1526-200

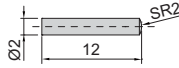
short spherical points (included)

Unit: mm



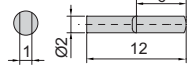
long spherical/flat points (included)

Unit: mm



spherical blade points (included)

Unit: mm



1526-200

preset buttons

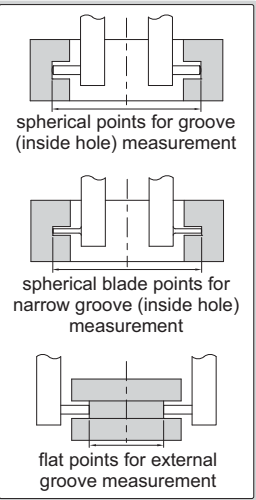


DATA OUTPUT

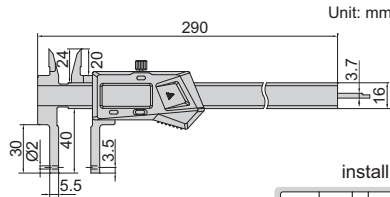
zero setting block for external measurement (included)



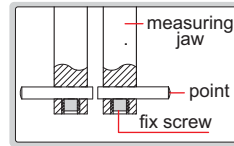
measure internal and external grooves



- Supplied with 3 pairs of points and zero setting block for external measurement
- Resolution: 0.01mm/0.0005"
- Buttons: on/off, set, mm/inch, preset (+, -)
- Automatic power off, move the digital unit to turn on power
- Battery CR2032
- Data output
- Made of stainless steel
- Optional accessory: points, data output cable (code 7315-21, 7302-21)



install points



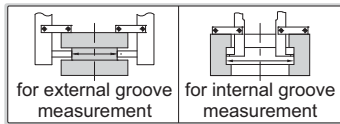
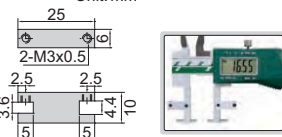
Point	Range	Accuracy	Application
short spherical points	12-212mm/0.5-8.5" (internal)	±0.03mm	for grooves inside small hole
long spherical/flat points	24-224mm/1-8.8" (internal) 0-187mm/0-7.5" (external)	±0.03mm	spherical points for grooves inside hole flat points for external grooves
spherical blade points	24-224mm/1-8.8" (internal) 0-187mm/0-7.5" (external)	±0.03mm	for narrow grooves inside hole

Depth stop (optional)

Unit: mm

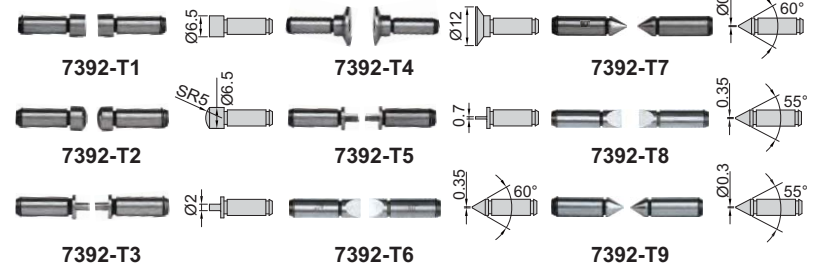


6143



Code
6143

Multifunctional points (optional)



Code	Type	Code	Type	Code	Type
7392-T1*	flat	7392-T4*	disk	7392-T7*	point
7392-T2*	spherical	7392-T5*	blade	7392-T8*	knife-edge
7392-T3*	spline	7392-T6*	knife-edge	7392-T9*	point

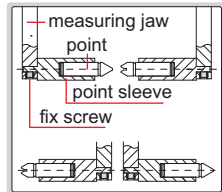
* It is necessary to use point sleeve (code 1526-T101) for these points

Point sleeve (optional)



1526-T101

installation



Code
1526-T101

Ball points (optional)



7391-T5

Code	Ball dia.(D)
7391-T3*	SØ2.0mm
7391-T4*	SØ2.5mm
7391-T5*	SØ3.0mm
7391-T6*	SØ3.5mm
7391-T7*	SØ4.0mm
7391-T8*	SØ4.5mm
7391-T9*	SØ5.0mm
7391-T10*	SØ6.0mm



* It is necessary to use point sleeve (code 1526-T101) for these points

Screw thread points (optional)



Internal thread (60° thread angle)

Code	Pitch
7321-T11*	0.4-0.5mm/64-48TPI
7321-T12*	0.6-0.9mm/44-28TPI
7321-T13*	1-1.75mm/24-14TPI
7321-T14*	2-3mm/13-9TPI
7321-T15*	3.5-5mm/8-5TPI
7321-T16*	5.5-7mm/4.5-3.5TPI
7321-T1S*	6 pairs/set, including all above points

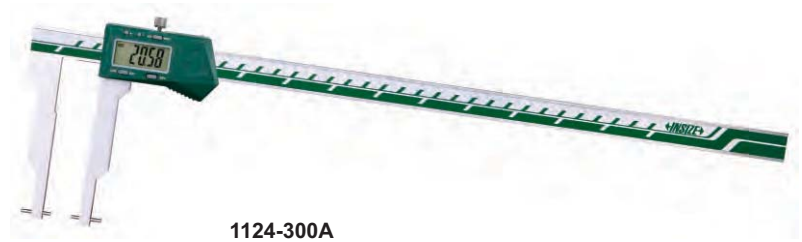
External thread (60° thread angle)

Code	Pitch
7381-T11*	0.4-0.5mm/64-48TPI
7381-T12*	0.6-0.9mm/44-28TPI
7381-T13*	1-1.75mm/24-14TPI
7381-T14*	2-3mm/13-9TPI
7381-T15*	3.5-5mm/8-5TPI
7381-T16*	5.5-7mm/4.5-3.5TPI
7381-TS*	6 pairs/set, including all above points



DATA
OUTPUT

DIGITAL CALIPER WITH INTERCHANGEABLE POINTS CODE 1124-300A



1124-300A

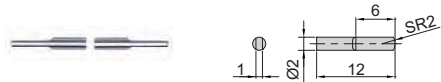
short spherical/flat points (included) Unit: mm



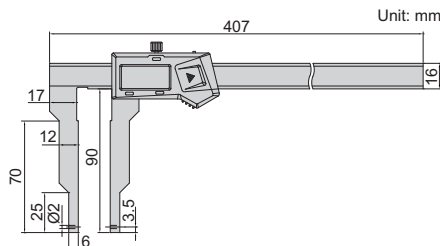
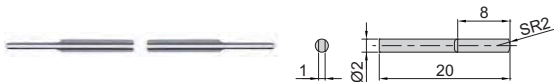
long spherical/flat points (included) Unit: mm



short spherical blade points (included) Unit: mm



long spherical blade points (included) Unit: mm



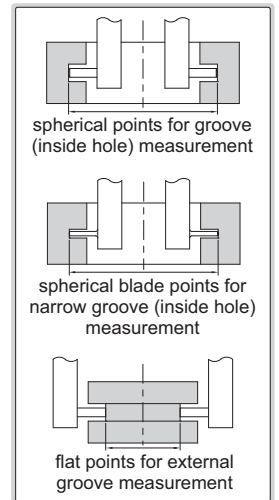
preset buttons



depth stop **6143**
(optional)

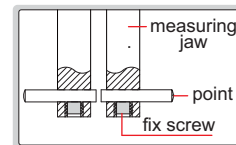


measure internal and external grooves



- Supplied with 4 pairs of points and zero setting block for external measurement
- Resolution: 0.01mm/0.0005"
- Buttons: on/off, set, mm/inch, preset (+, -)
- Automatic power off, move the digital unit to turn on power
- Battery CR2032
- Data output
- Made of stainless steel
- Optional accessory: points (code **1526-T101**, **7392**, **7391**, **7381**, **7321**), depth stop (code **6143**), data output cable (code **7315-21**, **7302-21**)

install points



zero setting block for external measurement (included)



Point	Range	Accuracy	Application
short spherical/flat points	24-324mm/1-12.7" (internal) 0-288mm/0-11.3" (external)	±0.04mm	spherical points for grooves inside hole (small hole) flat points for external grooves
long spherical/flat points	40-340mm/1.5-13.3" (internal) 0-272mm/0-10.7" (external)	±0.04mm	spherical points for grooves inside hole (large hole) flat points for external grooves
short spherical blade points	24-324mm/1-12.7" (internal) 0-288mm/0-11.3" (external)	±0.04mm	for narrow grooves inside hole (small hole)
long spherical blade points	40-340mm/1.5-13.3" (internal) 0-272mm/0-10.7" (external)	±0.04mm	for narrow grooves inside hole (large hole)

Multifunctional points 7392*
(optional, refer to 1526-200 for more details)



Ball points 7391* (optional, refer to 1526-200 for more details)



Screw thread points 7381*, 7321* (optional, refer to 1526-200 for more details)



* It is necessary to use point sleeve (code **1526-T101**) for these points

DIGITAL CALIPER WITH INTERCHANGEABLE POINTS

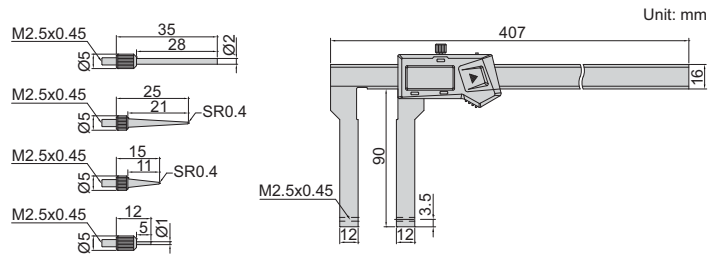
DATA OUTPUT

VARIOUS POINTS ARE AVAILABLE (PAGE 146-148)



1530-300

- Supplied with 4 pairs of points and zero setting block for external measurement
- Resolution: 0.01mm/0.0005"
- Buttons: on/off, set, mm/inch, preset (+, -)
- Automatic power off, move the digital unit to turn on power
- Battery CR2032
- Data output
- Made of stainless steel
- Optional accessory: points (page 146~148), depth stop (code 6143), data output cable (code 7315-21, 7302-21)

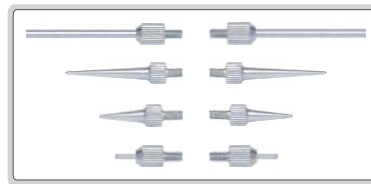


zero setting block for external measurement (included)

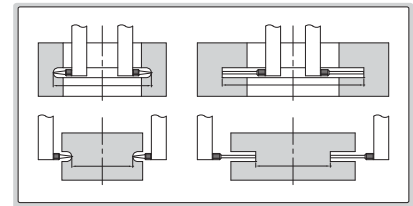
depth stop 6143 (optional)



4 pairs of points (included)



measure internal and external grooves



Code	Range*	Accuracy
1530-300	0-300mm/0-12"	±0.04mm

*For different points, the measuring range changes accordingly

DIGITAL INSIDE GROOVE CALIPERS

preset buttons

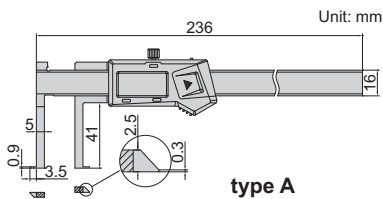


1520-150

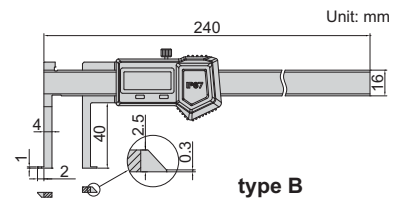
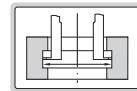


1520-150P

depth stop 6143 (optional)



type A



type B

- Measure diameter of grooves inside small bores
- Resolution: 0.01mm/0.0005"
- Buttons type A: on/off, set, mm/inch, preset (+, -), type B: on/off, zero, mm/inch, ABS/REL, hold
- Battery CR2032
- Made of stainless steel
- Optional accessory: depth stop (code 6143)

No dust/waterproof, with data interface (data output cable code 7315-21, 7302-21, optional)

Code	Range	Type	Accuracy
1520-150	11-150mm/0.43-6"	A	±0.04mm

No dust/waterproof, built-in wireless

Code	Range	Type	Accuracy
1520-150WL	11-150mm/0.43-6"	A	±0.04mm

IP67 dust/waterproof, without data interface, no automatic power off, set zero after power on each time

Code	Range	Type	Accuracy
1520-150P	8-150mm/0.31-6"	B	±0.04mm

DIGITAL INSIDE GROOVE CALIPERS

depth stop **6143**
(optional)



preset buttons



1120-150A
type A

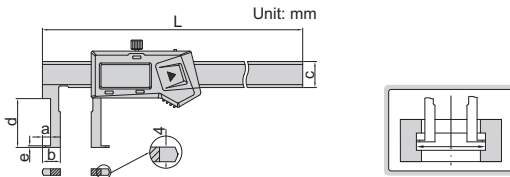


1120-150B
type B



1120-150P
type C

- Measure groove diameter
- Resolution: 0.01mm/0.0005"
- Buttons type A: on/off, set, mm/inch, preset (+, -),
type B: on/off, zero, mm/inch,
type C: on/off, zero, mm/inch, ABS/REL, hold
- Battery CR2032
- Made of stainless steel
- Optional accessory: depth stop
(code **6143**, for calipers with c=16mm)



No dust/waterproof, with data interface, preset (no need to add the width of the jaws on the reading)

(mm)

Code	Range	Type	Accuracy	L	a	b	c	d	e	Data output cable (optional)
1120-150A	22-150mm/0.87-6"	A	±0.04mm	250	5	11	16	30	1	7315-21, 7302-21
1120-1501	35-150mm/1.38-6"	A	±0.06mm	250	6	17.5	16	60	1.5	7315-21, 7302-21
1120-200A	25-200mm/0.98-8"	A	±0.04mm	310	5	12.5	16	40	1	7315-21, 7302-21
1120-2001	40-200mm/1.57-8"	A	±0.06mm	310	7	20	16	70	2.5	7315-21, 7302-21
1120-300A	30-300mm/1.18-12"	A	±0.05mm	410	5	15	16	50	1.5	7315-21, 7302-21
1120-3001	50-300mm/1.97-12"	A	±0.07mm	410	8	25	16	80	2.5	7315-21, 7302-21
1120-500	40-500mm/1.57-20"	A	±0.07mm	680	5	20	24	90	2.2	7315-22, 7302-22
1120-5001	60-500mm/2.36-20"	A	±0.08mm	680	10	30	24	120	3.4	7315-22, 7302-22
1120-5002	80-500mm/3.15-20"	A	±0.08mm	680	16	40	24	150	5.2	7315-22, 7302-22

No dust/waterproof, built-in wireless, preset (no need to add the width of the jaws on the reading)

Code	Range	Type	Accuracy	L	a	b	c	d	e
1120-150AWL	22-150mm/0.87-6"	A	±0.04mm	250mm	5mm	11mm	16mm	30mm	1mm
1120-1501WL	35-150mm/1.38-6"	A	±0.06mm	250mm	6mm	17.5mm	16mm	60mm	1.5mm
1120-200AWL	25-200mm/0.98-8"	A	±0.04mm	310mm	5mm	12.5mm	16mm	40mm	1mm
1120-2001WL	40-200mm/1.57-8"	A	±0.06mm	310mm	7mm	20mm	16mm	70mm	2.5mm
1120-300AWL	30-300mm/1.18-12"	A	±0.05mm	410mm	5mm	15mm	16mm	50mm	1.5mm
1120-3001WL	50-300mm/1.97-12"	A	±0.07mm	410mm	8mm	25mm	16mm	80mm	2.5mm
1120-500WL	40-500mm/1.57-20"	A	±0.07mm	680mm	5mm	20mm	24mm	90mm	2.2mm
1120-5001WL	60-500mm/2.36-20"	A	±0.08mm	680mm	10mm	30mm	24mm	120mm	3.4mm
1120-5002WL	80-500mm/3.15-20"	A	±0.08mm	680mm	16mm	40mm	24mm	150mm	5.2mm

No dust/waterproof, no preset (need to add the width of the jaws on the reading)

Code	Range	Type	Accuracy	L	a	b	c	d	e
1120-150B	50-150mm/1.97-6"	B	±0.06mm	270mm	8mm	25mm	20mm	90mm	3.4mm
1120-200B	60-200mm/2.36-8"	B	±0.06mm	320mm	10mm	30mm	20mm	100mm	3.4mm
1120-300B	60-300mm/2.36-12"	B	±0.07mm	420mm	10mm	30mm	20mm	110mm	3.4mm

IP67 dust/waterproof, without data interface, no automatic power off, set zero after power on each time, no preset (need to add the width of the jaws on the reading)

Code	Range	Type	Accuracy	L	a	b	c	d	e
1120-150P	22-150mm/0.87-6"	C	±0.04mm	250mm	5mm	11mm	16mm	30mm	1mm

DIGITAL INSIDE POINT CALIPERS

2

DATA OUTPUT



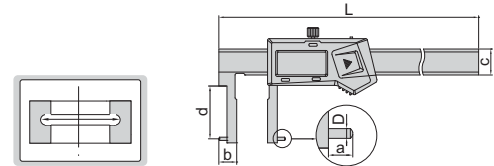
1121-150A
type A

depth stop 6143
(optional)



1121-150B
type B

- Measure groove diameter
- Resolution: 0.01mm/0.0005"
- Buttons type A: on/off, set, mm/inch, preset (+, -)
type B: on/off, zero, mm/inch
- Automatic power off, move the digital unit to turn on power
- Battery CR2032
- Data output
- Made of stainless steel
- Optional accessory: depth stop
(code 6143, for calipers with c=16mm)



With data interface, preset (no need to add the width of the jaws on the reading)

(mm)

Code	Range	Type	Accuracy	L	a	b	c	d	D	Data output cable (optional)
1121-150A	24-150mm/0.94-6"	A	±0.04mm	250	5	12	16	28	Ø2	7315-21, 7302-21
1121-1501	35-150mm/1.38-6"	A	±0.05mm	250	6	17.5	16	60	Ø2	7315-21, 7302-21
1121-200A	25-200mm/0.98-8"	A	±0.04mm	310	5	12.5	16	37	Ø2	7315-21, 7302-21
1121-2001	40-200mm/1.57-8"	A	±0.05mm	310	7	20	16	70	Ø3	7315-21, 7302-21
1121-300A	30-300mm/1.18-12"	A	±0.07mm	410	5	15	16	50	Ø2	7315-21, 7302-21
1121-3001A	50-300mm/1.97-12"	A	±0.07mm	410	8	25	16	77	Ø3	7315-21, 7302-21
1121-500A	40-500mm/1.57-20"	A	±0.07mm	680	5	20	24	90	Ø3	7315-22, 7302-22
1121-5001	60-500mm/2.36-20"	A	±0.08mm	680	10	30	24	120	Ø3	7315-22, 7302-22
1121-5002	80-500mm/3.15-20"	A	±0.08mm	680	16	40	24	150	Ø3	7315-22, 7302-22

Built-in wireless, preset (no need to add the width of the jaws on the reading)

Code	Range	Type	Accuracy	L	a	b	c	d	D
1121-150AWL	24-150mm/0.94-6"	A	±0.04mm	250mm	5mm	12mm	16mm	28mm	Ø2mm
1121-1501WL	35-150mm/1.38-6"	A	±0.05mm	250mm	6mm	17.5mm	16mm	60mm	Ø2mm
1121-200AWL	25-200mm/0.98-8"	A	±0.04mm	310mm	5mm	12.5mm	16mm	37mm	Ø2mm
1121-2001WL	40-200mm/1.57-8"	A	±0.05mm	310mm	7mm	20mm	16mm	70mm	Ø3mm
1121-300AWL	30-300mm/1.18-12"	A	±0.07mm	410mm	5mm	15mm	16mm	50mm	Ø2mm
1121-3001AWL	50-300mm/1.97-12"	A	±0.07mm	410mm	8mm	25mm	16mm	77mm	Ø3mm
1121-500AWL	40-500mm/1.57-20"	A	±0.07mm	680mm	5mm	20mm	24mm	90mm	Ø3mm
1121-5001WL	60-500mm/2.36-20"	A	±0.08mm	680mm	10mm	30mm	24mm	120mm	Ø3mm
1121-5002WL	80-500mm/3.15-20"	A	±0.08mm	680mm	16mm	40mm	24mm	150mm	Ø3mm

No preset, need to add the width of the jaws on the reading

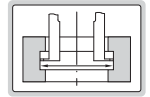
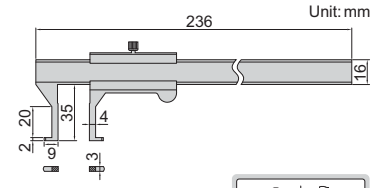
Code	Range	Type	Accuracy	L	a	b	c	d	D
1121-150B	50-150mm/1.97-6"	B	±0.06mm	270mm	8mm	25mm	20mm	90mm	Ø3mm
1121-200B	60-200mm/2.36-8"	B	±0.06mm	320mm	10mm	30mm	20mm	100mm	Ø3mm
1121-300B	60-300mm/2.36-12"	B	±0.07mm	420mm	10mm	30mm	20mm	110mm	Ø3mm

INSIDE GROOVE VERNIER CALIPER

- Measure diameter of grooves inside bores
- Made of stainless steel
- Satin chrome plated reading surface

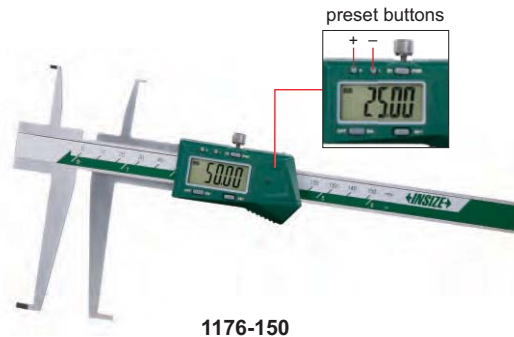


1262-150A



Code	Range	Graduation	Accuracy
1262-150A	18-150mm	0.02mm	±0.04mm

DIGITAL INSIDE GROOVE CALIPERS

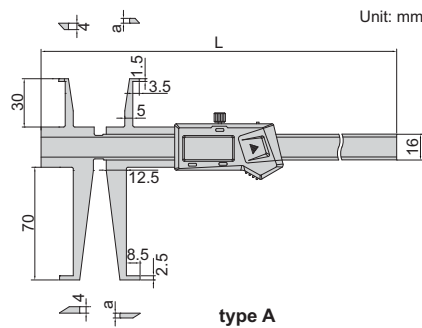


1176-150

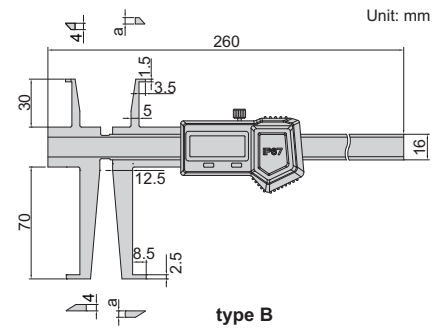


1176-150P

depth stop 6143 (optional)



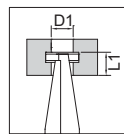
type A



type B

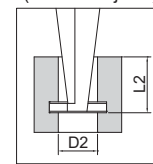
- Measure diameter of grooves inside bores
- Resolution: 0.01mm/0.0005"
- Buttons type A: on/off, set, mm/inch, preset (+, -)
type B: on/off, zero, mm/inch, ABS/REL, hold
- Battery CR2032
- Made of stainless steel
- Optional accessory: depth stop (code 6143)

sizes to be measured (use upper jaws)



D1	L1
Ø9	<8
Ø10	<15
Ø11~200	<30

sizes to be measured (use lower jaws)



D2	L2
Ø17	<16
Ø18	<28
Ø19	<40
Ø20	<50
Ø21	<58
Ø22~150	<70

No dust/waterproof, with data interface (data output cable code 7315-21, 7302-21, optional)

Code	Range of upper jaw	Range of lower jaw	Type	Accuracy	L	a
1176-150	9-150mm/0.35-6"	17-150mm/0.70-6"	A	±0.04mm	260mm	3mm
1176-200	9-200mm/0.35-8"	17-200mm/0.70-8"	A	±0.05mm	320mm	4mm

No dust/waterproof, built-in wireless

Code	Range of upper jaw	Range of lower jaw	Type	Accuracy	L	a
1176-150WL	9-150mm/0.35-6"	17-150mm/0.70-6"	A	±0.04mm	260mm	3mm
1176-200WL	9-200mm/0.35-8"	17-200mm/0.70-8"	A	±0.05mm	320mm	4mm

IP67 dust/waterproof, without data interface, no automatic power off, set zero after power on each time

Code	Range of upper jaw	Range of lower jaw	Type	Accuracy	a
1176-150P	9-150mm/0.35-6"	17-150mm/0.70-6"	B	±0.04mm	4mm

DIGITAL DEEP HOLE INSIDE GROOVE CALIPERS

DATA OUTPUT



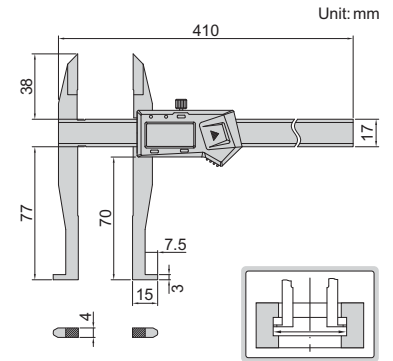
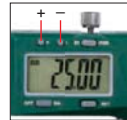
1129-300

- Measure diameter of grooves inside deep holes
- Resolution: 0.01mm/0.0005"
- Buttons: on/off, set, mm/inch, preset (+, -)
- Automatic power off, move the digital unit to turn on power
- Battery CR2032
- Made of stainless steel
- Optional accessory: depth stop (code 6143)

depth stop 6143 (optional)



preset buttons



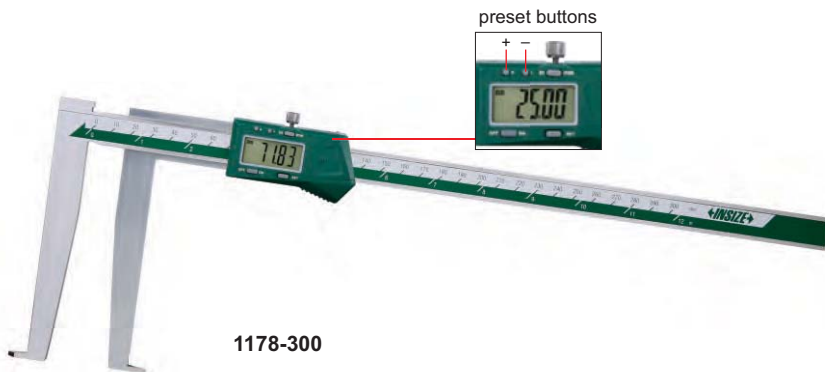
With data interface
(data output cable code 7315-21, 7302-21, optional)

Code	Range of upper jaw	Range of lower jaw	Accuracy
1129-300	0-300mm/0-12"	30-300mm/1.2-12"	±0.04mm

Built-in wireless

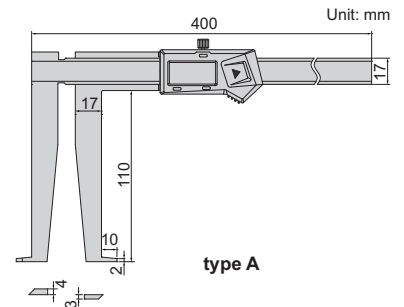
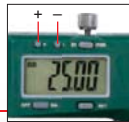
Code	Range of upper jaw	Range of lower jaw	Accuracy
1129-300WL	0-300mm/0-12"	30-300mm/1.2-12"	±0.04mm

DIGITAL INSIDE GROOVE CALIPERS



1178-300

preset buttons

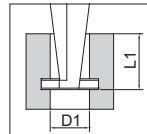


type A

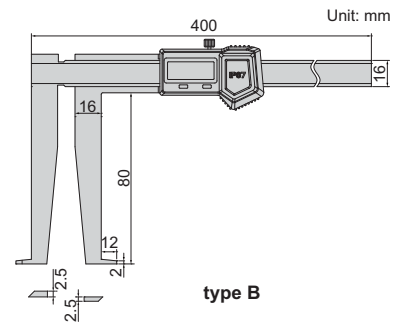


1178-300P

sizes to be measured



depth stop 6143 (optional)



type B

- Measure diameter of grooves inside bores
- Resolution: 0.01mm/0.0005"
- Buttons type A: on/off, set, mm/inch, preset (+, -), type B: on/off, zero, mm/inch, ABS/REL, hold
- Battery CR2032
- Made of stainless steel
- Optional accessory: depth stop (code 6143)

No dust/waterproof, with data interface
(data output cable code 7315-21, 7302-21, optional)

Code	Range	Type	Accuracy
1178-300	25-300mm/1.18-12"	A	±0.05mm

No dust/waterproof, built-in wireless

Code	Range	Type	Accuracy
1178-300WL	25-300mm/1.18-12"	A	±0.05mm

IP67 dust/waterproof, without data interface, no automatic power off, set zero after power on each time

Code	Range	Type	Accuracy
1178-300P	33-300mm/1.30-12"	B	±0.05mm

DATA OUTPUT

- Measure distance of grooves
- Resolution: 0.01mm/0.0005"
- Buttons: on/off, set, mm/inch, preset (+, -)
- Automatic power off, move the digital unit to turn on power
- Data output
- Made of stainless steel



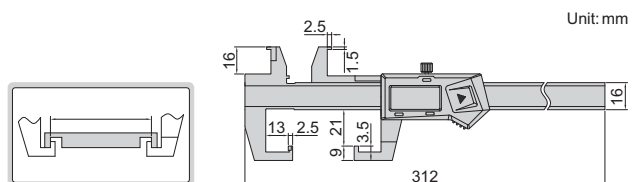
1128-200

With data interface (data output cable code 7315-21, 7302-21, optional)

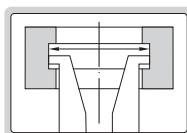
Code	Range of upper jaw	Range of lower jaw	Accuracy
1128-200	10-200mm/0.39-8"	3-200mm/0.12-8"	±0.03mm

Built-in wireless

Code	Range of upper jaw	Range of lower jaw	Accuracy
1128-200WL	10-200mm/0.39-8"	3-200mm/0.12-8"	±0.03mm


DATA OUTPUT

- Upper jaws for measuring diameter of grooves
- Resolution: 0.01mm/0.0005"
- Buttons: on/off, zero, mm/inch
- Automatic power off, move the digital unit to turn on power
- Battery CR2032
- Made of stainless steel



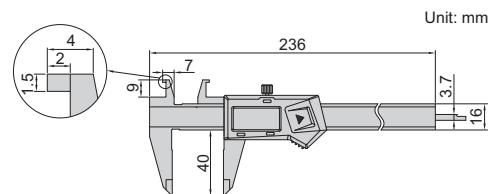
1191-150

With data interface (data output cable code 7315-21, 7302-21, optional)

Code	Range of upper jaw	Range of lower jaw	Accuracy
1191-150	8-150mm/0.3-6"	0-150mm/0-6"	±0.03mm

Built-in wireless

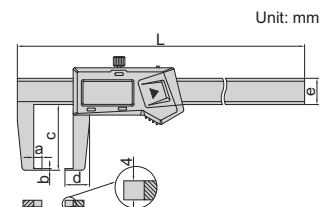
Code	Range of upper jaw	Range of lower jaw	Accuracy
1191-150WL	8-150mm/0.3-6"	0-150mm/0-6"	±0.03mm


DATA OUTPUT

- Measure grooves and recesses
- Resolution: 0.01mm/0.0005"
- Buttons: on/off, zero, mm/inch
- Automatic power off, move the digital unit to turn on power
- Battery CR2032
- Made of stainless steel
- Optional accessory: depth stop (code 6143)



1187-150A

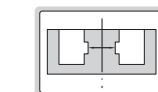


With data interface

Code	Range	Accuracy	L	a	b	c	d	e	Data output cable (optional)
1187-150A	0-150mm/0-6"	±0.04mm	250	5	1	40	15	16	7315-21, 7302-21
1187-200A	0-200mm/0-8"	±0.05mm	310	9	1.5	80	23	16	7315-21, 7302-21
1187-300A	0-300mm/0-12"	±0.06mm	490	12	2	150	36	24	7315-22, 7302-22

Built-in wireless

Code	Range	Accuracy	L	a	b	c	d	e
1187-150AWL	0-150mm/0-6"	±0.04mm	250	5	1	40	15	16
1187-200AWL	0-200mm/0-8"	±0.05mm	310	9	1.5	80	23	16
1187-300AWL	0-300mm/0-12"	±0.06mm	490	12	2	150	36	24



depth stop 6143 (optional)



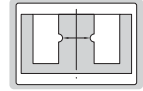
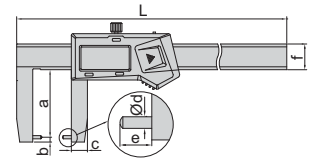
DIGITAL OUTSIDE POINT CALIPERS

DATA OUTPUT

- Measure wall thickness inside bores and recesses
- Resolution: 0.01mm/0.0005"
- Buttons: on/off, zero, mm/inch
- Automatic power off, move the digital unit to turn on power
- Battery CR2032
- Made of stainless steel
- Optional accessory: depth stop (code 6143)



1185-150A



With data interface

Code	Range	Accuracy	L	a	b	c	Ød	e	f	Data output cable (optional)
1185-150A	0-150mm/0-6"	±0.04mm	250	40	3	10	2	5	16	7315-21, 7302-21
1185-200A	0-200mm/0-8"	±0.05mm	310	80	3	14	3	9	16	7315-21, 7302-21
1185-300A	0-300mm/0-12"	±0.06mm	490	150	3	20	3	12	24	7315-22, 7302-22

(mm)

Built-in wireless

Code	Range	Accuracy	L	a	b	c	Ød	e	f
1185-150AWL	0-150mm/0-6"	±0.04mm	250	40	3	10	2	5	16
1185-200AWL	0-200mm/0-8"	±0.05mm	310	80	3	14	3	9	16
1185-300AWL	0-300mm/0-12"	±0.06mm	490	150	3	20	3	12	24

(mm)

depth stop 6143 (optional)



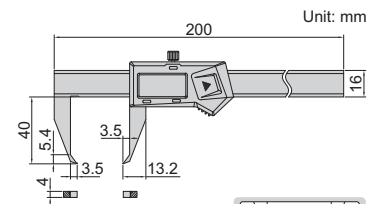
DIGITAL OUTSIDE GROOVE CALIPERS

DATA OUTPUT

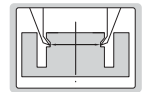
- Measure grooves and recesses in small spaces
- Resolution: 0.01mm/0.0005"
- Buttons: on/off, zero, mm/inch
- Automatic power off, move the digital unit to turn on power
- Battery CR2032
- Made of stainless steel



1535-100



Unit: mm



With data interface (data output cable code 7315-21, 7302-21, optional)

Code	Range	Accuracy
1535-100	0-100mm/0-4"	±0.03mm

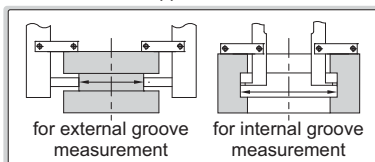


Built-in wireless

Code	Range	Accuracy
1535-100WL	0-100mm/0-4"	±0.03mm

DEPTH STOP FOR CALIPERS

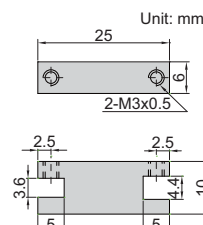
application



6143

- Supplied in pair
- Made of stainless steel
- Suitable for caliper series 1124, 1526, 1530, 1520, 1176, 1178, 1120, 1121, 1187, 1129 and 1185

Code 6143



Unit: mm



DATA OUTPUT

DIGITAL CALIPERS WITH POSITIONING SURFACES

- Lower jaws with positioning surfaces, for measuring inside diameters quickly
- Resolution: 0.01mm/0.0005"
- Buttons: on/off, set, mm/inch, preset (+, -)
- Automatic power off, move the digital unit to turn on power
- Battery CR2032
- Made of stainless steel



1534-200

preset buttons

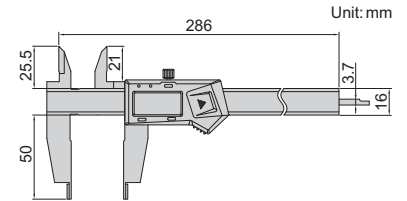
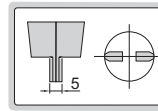
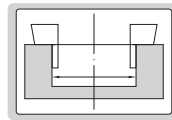


With data interface (data output cable code 7315-21, 7302-21, optional)

Code	Range	Accuracy
1534-200	0-200mm/0-8"	±0.03mm

Built-in wireless

Code	Range	Accuracy
1534-200WL	0-200mm/0-8"	±0.03mm



Unit: mm

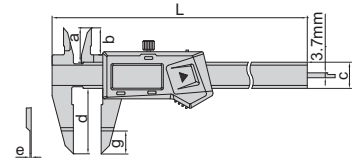
DATA OUTPUT

DIGITAL BLADE CALIPERS

- The blade jaws fit into small grooves
- Resolution: 0.01mm/0.0005"
- Buttons: on/off, zero, mm/inch
- Automatic power off, move the digital unit to turn on power
- Battery CR2032
- Made of stainless steel

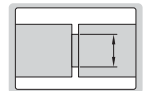


1188-150A



With data interface (data output cable code 7315-21, 7302-21, optional)

Code	Range	Accuracy	L	a	b	c	d	e	g
1188-150A	0-150mm/0-6"	±0.03mm	235mm	21mm	16.5mm	16mm	40mm	0.85mm	17mm
1188-200A	0-200mm/0-8"	±0.03mm	297mm	24mm	20mm	16mm	50mm	0.85mm	17mm
1188-300A	0-300mm/0-12"	±0.04mm	390mm	26mm	21.5mm	16mm	60mm	1.00mm	17mm



Built-in wireless

Code	Range	Accuracy	L	a	b	c	d	e	g
1188-150AWL	0-150mm/0-6"	±0.03mm	235mm	21mm	16.5mm	16mm	40mm	0.85mm	17mm
1188-200AWL	0-200mm/0-8"	±0.03mm	297mm	24mm	20mm	16mm	50mm	0.85mm	17mm
1188-300AWL	0-300mm/0-12"	±0.04mm	390mm	26mm	21.5mm	16mm	60mm	1.00mm	17mm

DIGITAL SMALL POINT CALIPERS

- Small pointed jaws fit into small grooves and recesses
- Resolution: 0.01mm/0.0005"
- Buttons: on/off, zero, mm/inch
- Automatic power off, move the digital unit to turn on power
- Battery CR2032
- Made of stainless steel



1169-150

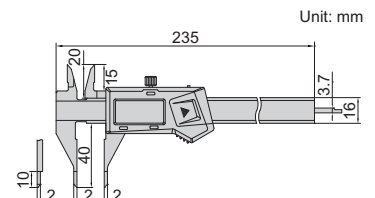
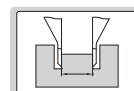
DATA OUTPUT

With data interface (data output cable code 7315-21, 7302-21, optional)

Code	Range	Accuracy
1169-150	0-150mm/0-6"	±0.03mm

Built-in wireless

Code	Range	Accuracy
1169-150WL	0-150mm/0-6"	±0.03mm



Unit: mm

DIGITAL POINT CALIPERS

DATA OUTPUT

- Pointed jaws fit into small grooves and recesses
- Resolution: 0.01mm/0.0005"
- Buttons: on/off, zero, mm/inch
- Automatic power off, move the digital unit to turn on power
- Battery CR2032
- Made of stainless steel



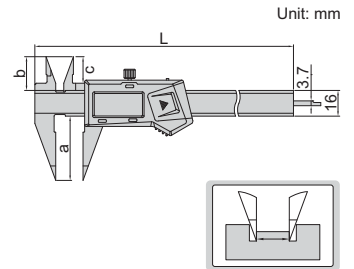
1183-150A

With data interface (data output cable code 7315-21, 7302-21, optional)

Code	Range	Accuracy	L	a	b	c
1183-150A	0-150mm/0-6"	±0.03mm	236mm	40mm	21mm	16.5mm
1183-200A	0-200mm/0-8"	±0.03mm	286mm	50mm	24mm	19.5mm
1183-300A	0-300mm/0-12"	±0.03mm	400mm	60mm	25mm	21.5mm

Built-in wireless

Code	Range	Accuracy	L	a	b	c
1183-150AWL	0-150mm/0-6"	±0.03mm	236mm	40mm	21mm	16.5mm
1183-200AWL	0-200mm/0-8"	±0.03mm	286mm	50mm	24mm	19.5mm
1183-300AWL	0-300mm/0-12"	±0.03mm	400mm	60mm	25mm	21.5mm



DIGITAL CALIPERS WITH KNIFE EDGE LOWER JAWS

DATA OUTPUT

- Measure diameter of narrow grooves
- Resolution: 0.01mm/0.0005"
- Buttons: on/off, zero, mm/inch
- Automatic power off, move the digital unit to turn on power
- Battery CR2032
- Made of stainless steel



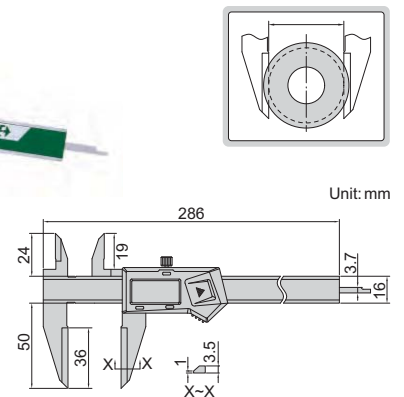
1532-200

With data interface (data output cable code 7315-21, 7302-21, optional)

Code	Range	Accuracy
1532-200	0-200mm/0-8"	±0.03mm

Built-in wireless

Code	Range	Accuracy
1532-200WL	0-200mm/0-8"	±0.03mm



DIGITAL INSIDE KNIFE-EDGE CALIPERS

DATA OUTPUT

- Measure diameter of deep step holes
- Resolution: 0.01mm/0.0005"
- Buttons: on/off, zero, mm/inch
- Automatic power off, move the digital unit to turn on power
- Battery CR2032
- Made of stainless steel



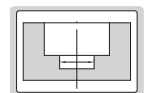
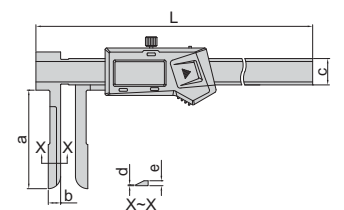
1123-150A

With data interface

Code	Range	Accuracy	L	a	b	c	d	e	Data output cable (optional)
1123-150A	15-150mm/0.6-6"	±0.05mm	250	60	12	16	0.3	3.5	7315-21, 7302-21
1123-200A	20-200mm/0.8-8"	±0.06mm	305	100	17	16	0.3	3.5	7315-21, 7302-21
1123-300A	24-300mm/0.9-12"	±0.06mm	500	150	22	24	0.5	3.5	7315-22, 7302-22

Built-in wireless

Code	Range	Accuracy	L	a	b	c	d	e
1123-150AWL	15-150mm/0.6-6"	±0.05mm	250	60	12	16	0.3	3.5
1123-200AWL	20-200mm/0.8-8"	±0.06mm	305	100	17	16	0.3	3.5



DATA OUTPUT

DIGITAL CALIPERS WITH LONG UPPER JAWS

- Long upper jaws for measuring diameter of deep holes
- Resolution: 0.01mm/0.0005"
- Buttons: on/off, zero, mm/inch
- Automatic power off, move the digital unit to turn on power
- Battery CR2032
- Made of stainless steel



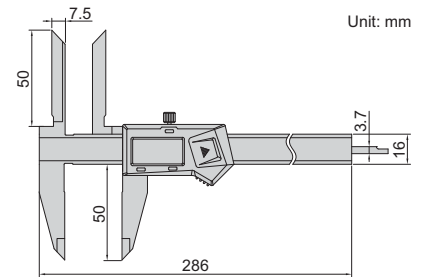
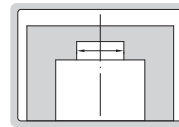
1138-200

With data interface (data output cable code 7315-21, 7302-21, optional)

Code	Range	Accuracy
1138-200	0-200mm/0-8"	±0.04mm

Built-in wireless

Code	Range	Accuracy
1138-200WL	0-200mm/0-8"	±0.04mm

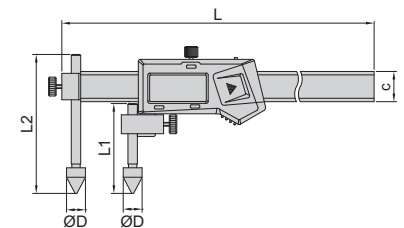


DATA OUTPUT

DIGITAL OFFSET CENTERLINE CALIPERS



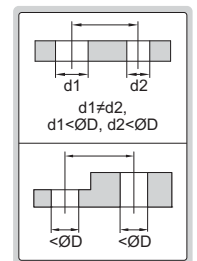
1192-150A



- Measure hole center distance in the same or offset planes
- Resolution: 0.01mm/0.0005"
- Buttons: on/off, set, mm/inch, preset (+, -)
- Automatic power off, move the digital unit to turn on power
- Battery CR2032
- Made of stainless steel

With data interface

Code	Range	Accuracy	c	ØD	L1	L2	L	Data output cable (optional)
1192-150A	10-150mm/0.4-6"	±0.05mm	16	10	46	79	236	7315-21, 7302-21
1192-200A	10-200mm/0.4-8"	±0.07mm	16	10	46	79	286	7315-21, 7302-21
1192-300A	10-300mm/0.4-12"	±0.09mm	16	10	46	79	396	7315-21, 7302-21
1192-500A	20-500mm/0.8-20"	±0.09mm	24	20	52	112	725	7315-22, 7302-22
1192-1000A	30-1000mm/1.2-40"	±0.12mm	31	30	52	112	1255	7315-22, 7302-22
1192-1500A	30-1500mm/1.2-60"	±0.15mm	42	30	52	112	1805	—



Built-in wireless

Code	Range	Accuracy	c	ØD	L1	L2	L
1192-150AWL	10-150mm/0.4-6"	±0.05mm	16	10	46	79	236
1192-200AWL	10-200mm/0.4-8"	±0.07mm	16	10	46	79	286
1192-300AWL	10-300mm/0.4-12"	±0.09mm	16	10	46	79	396
1192-500AWL	20-500mm/0.8-20"	±0.09mm	24	20	52	112	725

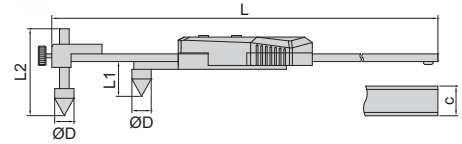
DIGITAL BACK-JAW CENTERLINE CALIPERS

DATA OUTPUT

- Measure hole center distance in the same or offset planes
- Resolution: 0.01mm/0.0005"
- Buttons: on/off, set, mm/inch, preset (+, -)
- Automatic power off, move the digital unit to turn on power
- Battery CR2032
- Made of stainless steel



1177-200



With data interface

(mm)

Code	Range	Accuracy	ØD	c	L1	L2	L	Data output cable (optional)
1177-200	10-200mm/0.4-8"	±0.10mm	10	16	18	45	310	7315-21, 7302-21
1177-300	10-300mm/0.4-12"	±0.10mm	10	16	18	45	410	7315-21, 7302-21
1177-500	20-500mm/0.8-20"	±0.10mm	20	24	26	70	692	7315-22, 7302-22
1177-1000	30-1000mm/1.2-40"	±0.12mm	30	31	39	70	1242	7315-22, 7302-22
1177-1500	30-1500mm/1.2-60"	±0.15mm	30	31	39	70	1745	7315-22, 7302-22

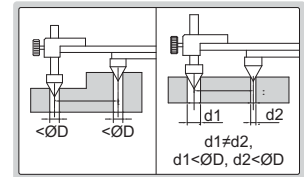
back-jaw



Built-in wireless

(mm)

Code	Range	Accuracy	ØD	c	L1	L2	L
1177-200WL	10-200mm/0.4-8"	±0.10mm	10	16	18	45	310
1177-300WL	10-300mm/0.4-12"	±0.10mm	10	16	18	45	410
1177-500WL	20-500mm/0.8-20"	±0.10mm	20	24	26	70	692



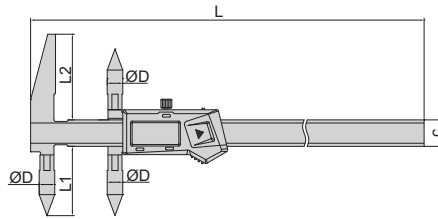
DIGITAL CENTERLINE AND EDGE TO CENTER CALIPERS

DATA OUTPUT

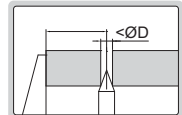


1525-300

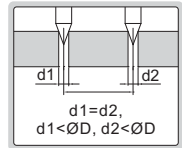
- Measure hole center distance or edge to hole center distance
- Resolution: 0.01mm/0.0005"
- Buttons: on/off, set, mm/inch, preset (+, -)
- Automatic power off, move the digital unit to turn on power
- Battery CR2032
- Made of stainless steel



measure edge to hole center distance



measure hole center distance



With data interface

(mm)

Code	Range of upper jaw (edge to center)	Range of lower jaw (center to center)	Accuracy	ØD	L1	L2	c	L	Data output cable (optional)
1525-300	5-300mm/0.2-12"	10-300mm/0.4-12"	±0.08mm	10	44.5	55	17	410	7315-21, 7302-21
1525-3001	10-300mm/0.4-12"	20-300mm/0.8-12"	±0.08mm	20	50	55	17	410	7315-21, 7302-21
1525-500	10-500mm/0.4-20"	20-500mm/0.8-20"	±0.09mm	20	40	50	24	690	7315-22, 7302-22
1525-1000	15-1000mm/0.6-40"	30-1000mm/1.2-40"	±0.12mm	30	60	70	31	1255	7315-22, 7302-22
1525-1500	15-1500mm/0.6-60"	30-1500mm/1.2-60"	±0.15mm	30	60	70	31	1760	7315-22, 7302-22

Built-in wireless

(mm)

Code	Range of upper jaw (edge to center)	Range of lower jaw (center to center)	Accuracy	ØD	L1	L2	c	L
1525-300WL	5-300mm/0.2-12"	10-300mm/0.4-12"	±0.08mm	10	44.5	55	17	410
1525-3001WL	10-300mm/0.4-12"	20-300mm/0.8-12"	±0.08mm	20	50	55	17	410
1525-500WL	10-500mm/0.4-20"	20-500mm/0.8-20"	±0.09mm	20	40	50	24	690

DATA OUTPUT

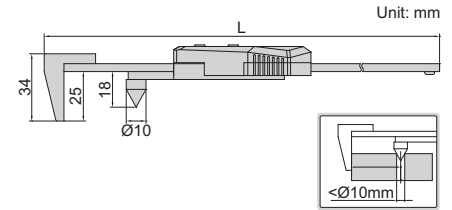
DIGITAL BACK-JAW EDGE TO CENTER CALIPERS

- Measure edge to hole center distance
- Resolution: 0.01mm/0.0005"
- Buttons: on/off, set, mm/inch, preset (+, -)
- Automatic power off, move the digital unit to turn on power
- Battery CR2032
- Data output
- Made of stainless steel
- Optional accessory: data output cable (code 7315-21, 7302-21)



1524-200

preset buttons



Code	Range	Accuracy	L
1524-200	5-200mm/0.2-8"	±0.1mm	310mm
1524-300	5-300mm/0.2-12"	±0.1mm	410mm

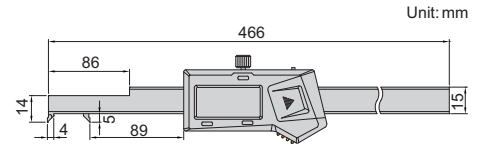
DATA OUTPUT

DIGITAL HOOK CALIPERS



1122-300

- Measure width and distance of grooves inside bores
- Resolution: 0.01mm/0.0005"
- Buttons: on/off, zero, mm/inch
- Automatic power off, move the digital unit to turn on power
- Battery CR2032
- Made of stainless steel

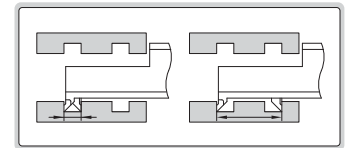


With data interface (data output cable code 7315-21, 7302-21, optional)

Code	Range	Accuracy
1122-300	4-300mm/0.16-12"	±0.04mm

Built-in wireless

Code	Range	Accuracy
1122-300WL	4-300mm/0.16-12"	±0.04mm



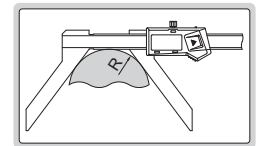
DATA OUTPUT

DIGITAL ARC RADIUS CALIPERS

- Measure the radius of arc less than half round
- Resolution: 0.01mm/0.0005"
- Buttons: on/off, zero, mm/inch
- Automatic power off, move the digital unit to turn on power
- Battery CR2032
- Made of stainless steel



1189-150B

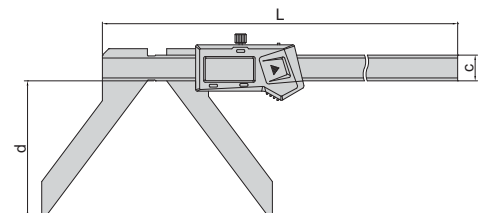


With data interface (data output cable code 7315-21, 7302-21, optional)

Code	Range (R)	Accuracy	L	c	d
1189-150B	5-150mm/0.2-6"	±0.05mm	263mm	16mm	65mm
1189-200B	5-200mm/0.2-8"	±0.07mm	313mm	16mm	85mm

Built-in wireless

Code	Range (R)	Accuracy	L	c	d
1189-150BWL	5-150mm/0.2-6"	±0.05mm	263mm	16mm	65mm
1189-200BWL	5-200mm/0.2-8"	±0.07mm	313mm	16mm	85mm



DIGITAL CALIPERS WITH ONE DIRECTION UPPER JAWS

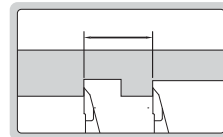
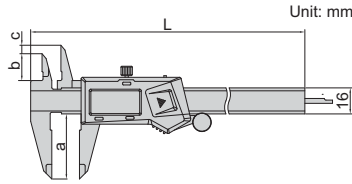


1184-200

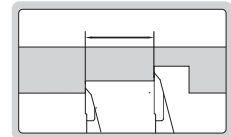


1184-150A

- Resolution: 0.01mm/0.0005"
- Buttons: zero, power on/off, inch/mm
- Automatic power off, move the digital unit to turn on power
- Battery CR2032
- Data output
- Made of stainless steel
- Optional accessory: data output cable (code 7315-21, 7302-21)



jaws with same height used for measuring the distance in same level



jaws with different height used for measuring the distance in different level

Jaws with same height (mm)

Code	Range	Accuracy	L	a	b	c
1184-150	0-150mm/0-6"	±0.03mm	236	40	17	0
1184-200	0-200mm/0-8"	±0.03mm	286	50	20	0
1184-300	0-300mm/0-12"	±0.03mm	400	60	22	0

Jaws with different height (mm)

Code	Range	Accuracy	L	a	b	c
1184-150A	0-150mm/0-6"	±0.03mm	236	40	17	5
1184-200A	0-200mm/0-8"	±0.03mm	286	50	20	8
1184-300A	0-300mm/0-12"	±0.03mm	400	60	22	10

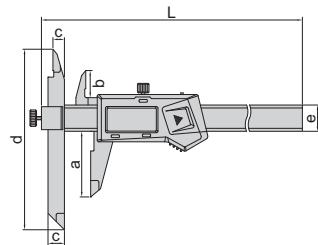
DIGITAL OFFSET CALIPERS

DATA OUTPUT



1186-150A

- The left jaw can slide up and down to facilitate measurement of stepped sections
- Resolution: 0.01mm/0.0005"
- Buttons: on/off, zero, mm/inch
- Automatic power off, move the digital unit to turn on power
- Battery CR2032
- Made of stainless steel

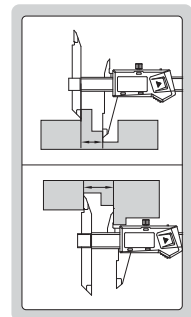


With data interface (data output cable code 7315-21, 7302-21, optional) (mm)

Code	Range	Accuracy	L	a	b	c	d	e	f
1186-150A	0-150mm/0-6"	±0.04mm	249	40	16.5	10	110	17	7
1186-200A	0-200mm/0-8"	±0.04mm	299	50	19.5	10	120	17	7
1186-300A	0-300mm/0-12"	±0.05mm	399	60	20.5	10	130	17	7

Built-in wireless (mm)

Code	Range	Accuracy	L	a	b	c	d	e	f
1186-150AWL	0-150mm/0-6"	±0.04mm	249	40	16.5	10	110	17	7
1186-200AWL	0-200mm/0-8"	±0.04mm	299	50	19.5	10	120	17	7
1186-300AWL	0-300mm/0-12"	±0.05mm	399	60	20.5	10	130	17	7



DATA OUTPUT

DIGITAL TUBE THICKNESS CALIPERS

- Measure wall thickness of tubes
- Resolution: 0.01mm/0.0005"
- Buttons: on/off, zero, mm/inch
- Automatic power off, move the digital unit to turn on power
- Battery CR2032
- Made of stainless steel



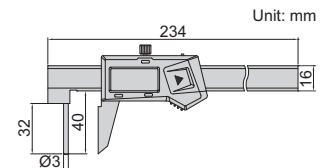
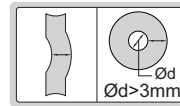
1161-150A

With data interface (data output cable code 7315-21, 7302-21, optional)

Code	Range	Accuracy
1161-150A	0-150mm/0-6"	±0.05mm

Built-in wireless

Code	Range	Accuracy
1161-150AWL	0-150mm/0-6"	±0.05mm



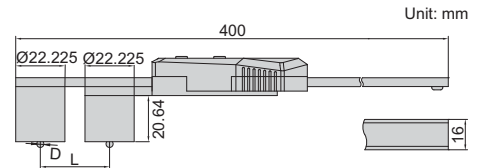
Unit: mm

DATA OUTPUT

DIGITAL CALIPER WITH INTERCHANGEABLE BALL TIPS



1527-3001



Unit: mm



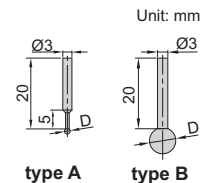
Ball tips (optional, supplied in pair)



1527-T101



1527-T104



Unit: mm

type A

type B

- Resolution 0.01mm/.0005"
- Buttons: on/off, set, mm/inch, preset (+, -)
- Automatic power off, move the digital unit to turn on power
- Battery CR2032, data output
- Made of stainless steel
- Optional accessory: ball tips, data output cable (code 7315-21, 7302-21)

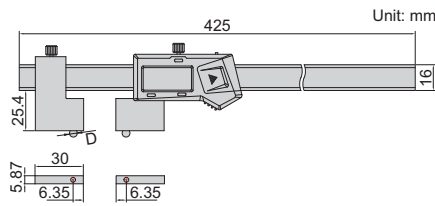
Code	Range	Accuracy
1527-3001	(22.22+D)~300mm*	±0.03mm

*"D" is the diameter of ball tips.

Code	Diameter (D)	Accuracy of diameter	Type	Material
1527-T101	1/16" (Ø1.5875mm)	±0.005mm	A	Ruby
1527-T102	1/8" (Ø3.175mm)	±0.005mm	B	Stainless steel
1527-T103	3/16" (Ø4.7625mm)	±0.005mm	B	Stainless steel
1527-T104	1/4" (Ø6.35mm)	±0.005mm	B	Stainless steel
1527-T105	3/8" (Ø9.525mm)	±0.005mm	B	Stainless steel
1527-T106	1/2" (Ø12.7mm)	±0.005mm	B	Stainless steel

DIGITAL CALIPER WITH INTERCHANGEABLE BALL TIPS

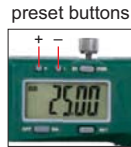
DATA OUTPUT



ball tips are optional

1528-3001

- Resolution 0.01mm/.0005"
- Buttons: on/off, set, mm/inch, preset (+, -)
- Automatic power off, move the digital unit to turn on power
- Battery CR2032, data output
- Made of stainless steel
- Optional accessory: ball tips, data output cable (code 7315-21, 7302-21)



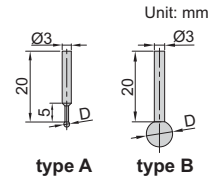
preset buttons

Ball tips (optional, supplied in pair)



1527-T101

1527-T104



type A

type B

Code	Diameter (D)	Accuracy of diameter	Type	Material
1527-T101	1/16" (Ø1.5875mm)	±0.005mm	A	Ruby
1527-T102	1/8" (Ø3.175mm)	±0.005mm	B	Stainless steel
1527-T103	3/16" (Ø4.7625mm)	±0.005mm	B	Stainless steel
1527-T104	1/4" (Ø6.35mm)	±0.005mm	B	Stainless steel
1527-T105	3/8" (Ø9.525mm)	±0.005mm	B	Stainless steel
1527-T106	1/2" (Ø12.7mm)	±0.005mm	B	Stainless steel

Code	Range	Accuracy
1528-3001	(12.7+D)~300mm*	±0.03mm

*"D" is the diameter of ball tips.

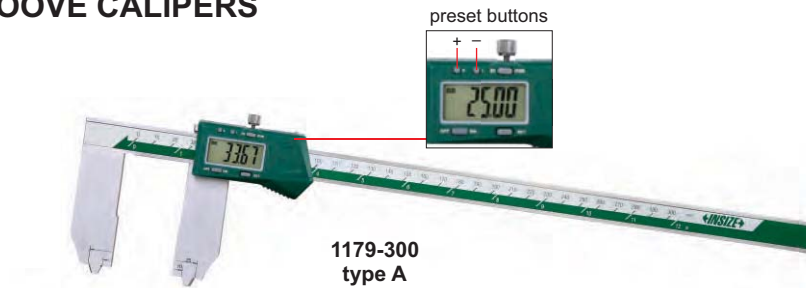
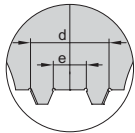
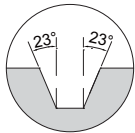
DIGITAL RTJ RING GROOVE CALIPERS

DATA OUTPUT

- Measure ring grooves of flange
- Resolution: 0.01mm/0.0005"
- Button function: on/off, set, zero, mm/inch, data preset
- Battery CR2032
- Made of stainless steel

applicable for RTJ ring grooves with angle 23°

d and e need to be added on the reading



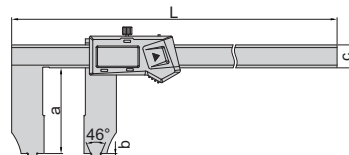
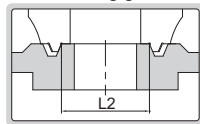
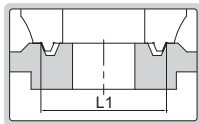
1179-300 type A



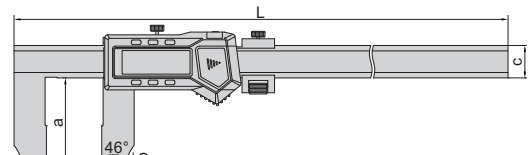
1179-600 type B

measure outside diameter of RTJ ring groove

measure inside diameter of RTJ ring groove



type A



type B

With data interface

Code	Range (inside diameter of RTJ ring groove)	Range (outside diameter of RTJ ring groove)	Angle of RTJ ring groove	Accuracy	Type	L	a	b	c	d	e	Data output cable (optional)
1179-300	10-300mm/0.4-12"	25-300mm/1-12"	23°	±0.06mm	A	410	63.5	4.5	17	25	10	7315-21, 7302-21
1179-600	10-600mm/0.4-24"	25-600mm/1-24"	23°	±0.07mm	B	770	65.5	4.5	24	25	10	7315-22, 7302-22
1179-1000	15-1000mm/0.6-40"	30-1000mm/1.2-40"	23°	±0.09mm	B	1220	90	5	31	30	15	7315-22, 7302-22

Built-in wireless

Code	Range (inside diameter of RTJ ring groove)	Range (outside diameter of RTJ ring groove)	Angle of RTJ ring groove	Accuracy	Type	L	a	b	c	d	e
1179-300WL	10-300mm/0.4-12"	25-300mm/1-12"	23°	±0.06mm	A	410	63.5	4.5	17	25	10
1179-600WL	10-600mm/0.4-24"	25-600mm/1-24"	23°	±0.07mm	B	770	65.5	4.5	24	25	10

RELATIVE PRODUCT: CRIMP HEIGHT MICROMETER (CODE 3266-25BA, 3566-25BA)

DATA OUTPUT

- Measure crimp height
- Resolution: 0.01mm/0.0005"
- Buttons: on/off, zero, mm/inch
- Automatic power off, move the digital unit to turn on power
- Battery CR2032, meet DIN862
- Made of stainless steel

With data interface (data output cable code 7315-21, 7302-21, optional)

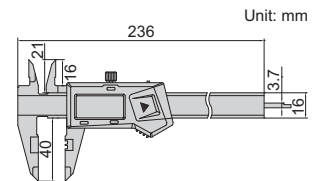
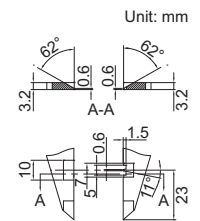
Code	Range	Accuracy
1165-150A	0-150mm/0-6"	±0.03mm

Built-in wireless

Code	Range	Accuracy
1165-150AWL	0-150mm/0-6"	±0.03mm



1165-150A



DATA OUTPUT

DIGITAL CALIPERS WITH LARGE MEASURING FACES

- Measure diameter of wire ropes, and thickness of soft materials like rubber, sponge, etc.
- Resolution: 0.01mm/0.0005"
- Buttons: on/off, zero, mm/inch
- Automatic power off, move the digital unit to turn on power
- Battery CR2032
- Made of stainless steel

With data interface (data output cable code 7315-21, 7302-21, optional)

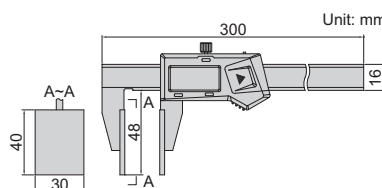
Code	Range	Accuracy
1172-200	0-200mm/0-8"	±0.07mm

Built-in wireless

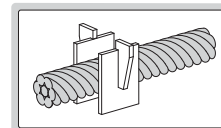
Code	Range	Accuracy
1172-200WL	0-200mm/0-8"	±0.07mm



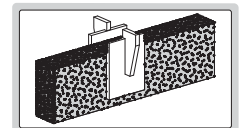
1172-200



measure diameter of wire ropes



measure thickness of rubber, sponge, etc.



DATA OUTPUT

DIGITAL CALIPERS WITH DISK FACES

- Measure thickness of soft sheets
- Resolution: 0.01mm/0.0005"
- Buttons: on/off, zero, mm/inch
- Automatic power off, move the digital unit to turn on power
- Battery CR2032
- Made of stainless steel

With data interface

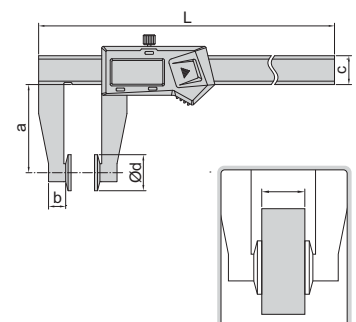
Code	Range	Accuracy	L	a	b	c	Ød	Data output cable (optional)
1533-150	0-150mm/0-6"	±0.04mm	245	50	11	16	20	7315-21, 7302-21
1533-200	0-200mm/0-8"	±0.05mm	310	80	11	16	30	7315-21, 7302-21
1533-500	0-500mm/0-20"	±0.07mm	680	150	20	24	50	7315-22, 7302-22

Built-in wireless

Code	Range	Accuracy	L	a	b	c	Ød
1533-150WL	0-150mm/0-6"	±0.04mm	245	50	11	16	20
1533-200WL	0-200mm/0-8"	±0.05mm	310	80	11	16	30
1533-500WL	0-500mm/0-20"	±0.07mm	680	150	20	24	50

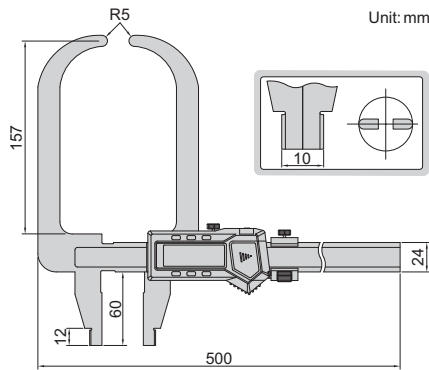


1533-150



DIGITAL WALL THICKNESS CALIPERS

DATA OUTPUT



1536-300

With data interface (data output cable code 7315-22, 7302-22, optional)

Code	Range	Accuracy
1536-300	0-300mm/0-12"	±0.05mm

Built-in wireless

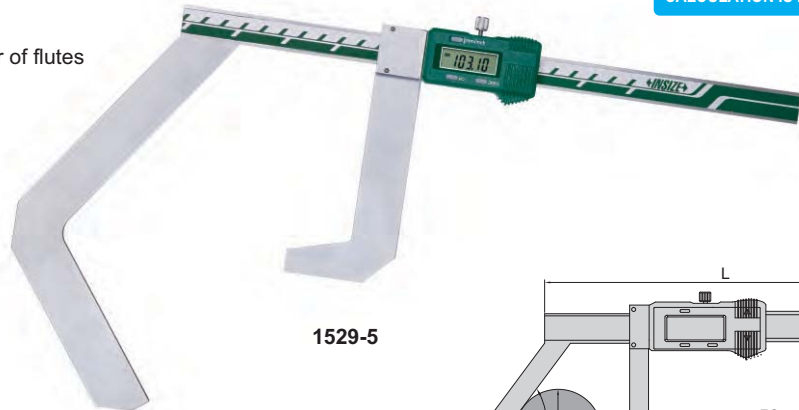
Code	Range	Accuracy
1536-300WL	0-300mm/0-12"	±0.05mm

- Measure wall thickness of helmets, domes and curved pots
- Resolution: 0.01mm/0.0005"
- Buttons: on/off, zero, mm/inch, ABS, data preset
- Automatic power off, move the digital unit to turn on power
- Battery CR2032
- Made of stainless steel

DIGITAL V SHAPE CALIPERS

DIRECT READING, CALCULATION IS NOT REQUIRED

- Measure the outside diameter of odd number of flutes (such as taps, reamers, end mills and gears)
- Direct reading, calculation is not required
- Resolution: 0.01mm/0.0005"
- Buttons: mm/inch, on/off, origin set
- Battery LR44, automatic power off
- After automatic power off, move the digital unit to turn on power
- Data output
- Made of stainless steel
- Optional accessory: 50mm calibration cylinder (code 6316-50), data output cable (code 7302-SPC9)



1529-5

DATA OUTPUT

Code	Range (D)	Flutes	Accuracy	Angle α	L
1529-3	50-200mm/2-8"	3	±0.06mm	60°	390mm
1529-5	50-200mm/2-8"	5	±0.06mm	108°	318mm
1529-19	50-200mm/2-8"	19	±0.06mm	85°15'47"	336mm
1529-23	50-200mm/2-8"	23	±0.06mm	70°26'5"	362mm
1529-31	50-200mm/2-8"	31	±0.06mm	75°29'2"	355mm

data output cable (optional) code 7302-SPC9



50mm calibration cylinder (optional) code 6316-50



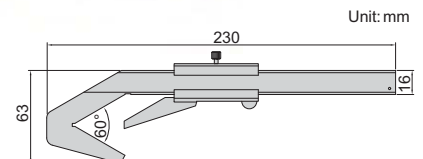
V SHAPE VERNIER CALIPER

- Measure outside diameter of three number of flutes (such as taps, reamers, end mills and gears)
- Made of stainless steel
- Satin chrome plated reading surface



1273-403

Code	Range	Graduation	Accuracy
1273-403	∅4-40mm	0.05mm	±0.05mm



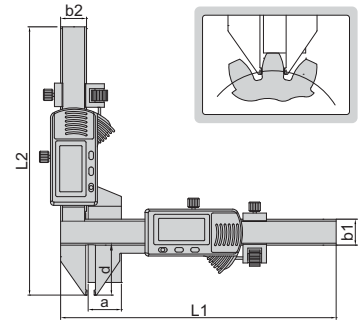
**ATTENTION:
NO DATA OUTPUT**

DIGITAL GEAR TOOTH CALIPERS

- Resolution: 0.01mm/0.0005"
- Carbide tips
- Buttons: zero, on/off, mm/inch
- Automatic power off, move the digital unit to turn on power
- Battery CR2032
- Made of stainless steel

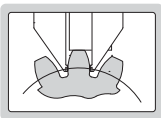


1181-M25A



Code	Range	Accuracy of height measurement	Accuracy of thickness measurement	Total accuracy	L1	L2	a	b1	b2	d
1181-M25A	M1-25mm	±0.03mm	±0.03mm	±0.04mm	170mm	165.5mm	21mm	16mm	16mm	30.5mm
1181-M50A	M5-50mm	±0.03mm	±0.03mm	±0.04mm	220mm	190mm	50.5mm	16mm	16mm	55mm

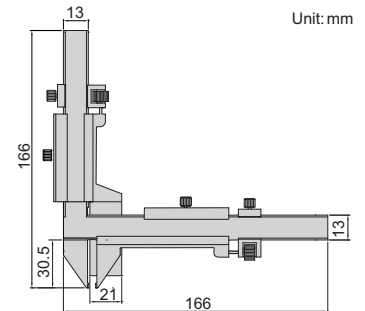
GEAR TOOTH VERNIER CALIPER



- Carbide tips
- Measure the tooth thickness by positioning the tooth height
- Made of stainless steel
- Satin chrome plated reading surface



1281-M26A



Code	Range	Graduation	Accuracy of height measurement	Accuracy of thickness measurement	Total accuracy
1281-M26A	M1-26mm	0.02mm	±0.03mm	±0.03mm	±0.04mm

RELATIVE PRODUCT: DISK BRAKE MICROMETER (CODE 3288-, 3588-)

DATA OUTPUT

DIGITAL DISK BRAKE CALIPERS

- Measure thickness of disk brakes
- Resolution 0.01mm/0.0005"
- Buttons: on/off, zero, mm/inch
- Automatic power off, move the digital unit to turn on power
- Battery CR2032
- Made of stainless steel



1162-125A

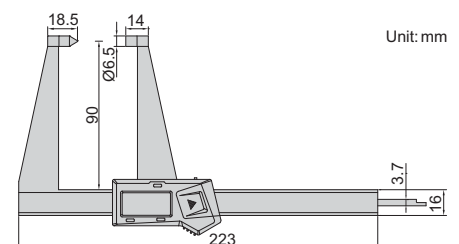


With data interface (data output cable code 7315-21, 7302-21, optional)

Code	Range	Accuracy
1162-125A	0-125mm/0-5"	±0.05mm

Built-in wireless

Code	Range	Accuracy
1162-125AWL	0-125mm/0-5"	±0.05mm



DIGITAL DISK BRAKE AND PAD CALIPERS

RELATIVE PRODUCT: DISK BRAKE MICROMETER (CODE 3288-, 3588-)

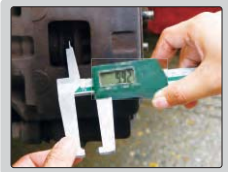
DATA OUTPUT

2

- Measure thickness of disk brakes and pad wear
- Resolution: 0.01mm/0.0005"
- Buttons: on/off, zero, mm/inch
- Automatic power off, move the digital unit to turn on power
- Battery CR2032
- Made of stainless steel



1167-150A

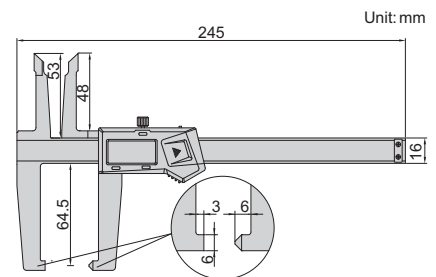


With data interface (data output cable code 7315-21, 7302-21, optional)

Code	Range	Accuracy
1167-150A	0-150mm/0-6"	±0.07mm

Built-in wireless

Code	Range	Accuracy
1167-150AWL	0-150mm/0-6"	±0.07mm



DIGITAL DRUM BRAKE CALIPERS

RELATIVE PRODUCT: DISK BRAKE MICROMETER (CODE 3288-, 3588-)

DATA OUTPUT



1168-300A

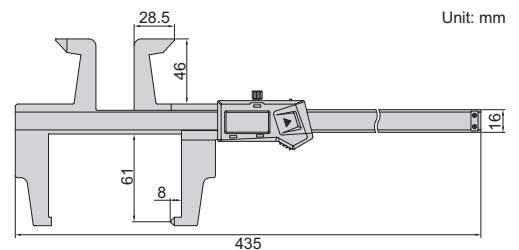
- Measure internal and external diameter of drum brakes
- Resolution 0.01mm/0.0005"
- Buttons: on/off, zero, mm/inch
- Automatic power off, move the digital unit to turn on power
- Battery CR2032
- Made of stainless steel

With data interface (data output cable code 7315-21, 7302-21, optional)

Code	Range	Accuracy
1168-300A	0-300mm/0-12"	±0.07mm

Built-in wireless

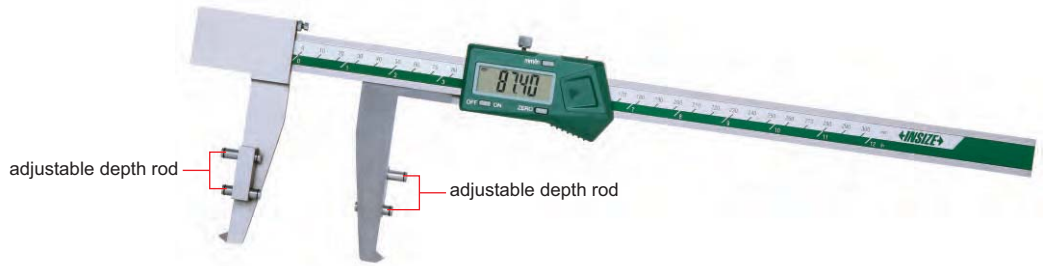
Code	Range	Accuracy
1168-300AWL	0-300mm/0-12"	±0.07mm



DATA OUTPUT

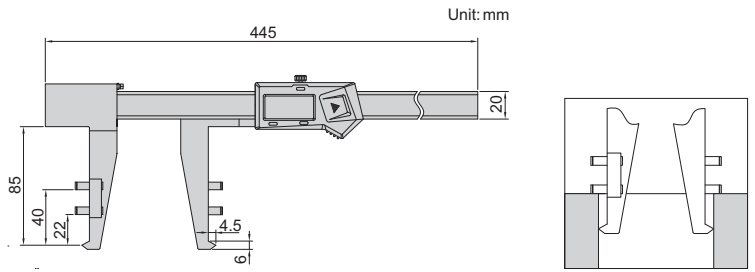
DIGITAL DRUM BRAKE CALIPER

calibration block (included)



1538-300

- Measure internal diameter of drum brakes
- Resolution: 0.01mm/0.0005"
- Buttons: on/off, zero, mm/inch
- Automatic power off, move the digital unit to turn on power
- Battery CR2032
- Data output
- Made of stainless steel
- Optional accessory: data output cable (code **7315-22**, **7302-22**)



Code	Range	Accuracy
1538-300	30-300mm/1.2-12"	±0.05mm

ATTENTION: IT IS NECESSARY TO SET ZERO AFTER POWER ON EACH TIME

IP67 WATERPROOF DIGITAL DEPTH GAGES

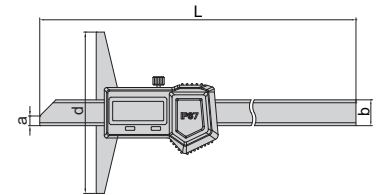
IP67 WATERPROOF

ATTENTION: NO DATA OUTPUT

- IP67 dust/waterproof
- Resolution: 0.01mm/0.0005"
- Button function: zero, on/off, mm/inch, ABS/REL, hold
- Meet DIN862
- Battery CR2032
- Made of stainless steel



1149-150



Code	Range	Accuracy	L	a	b	d
1149-150	0-150mm/0-6"	±0.03mm	240mm	6mm	16mm	100mm
1149-200	0-200mm/0-8"	±0.03mm	290mm	6mm	16mm	100mm
1149-300	0-300mm/0-12"	±0.03mm	390mm	6mm	16mm	150mm

ATTENTION: NO DATA OUTPUT

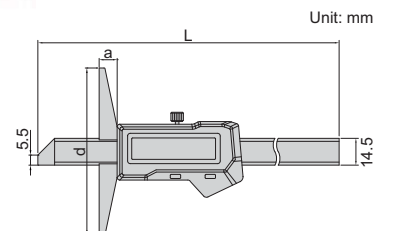
IP67 WATERPROOF

IP67 WATERPROOF DIGITAL DEPTH GAGES

- IP67 dust/waterproof
- Resolution: 0.01mm/0.0005"
- Large display
- Button function: zero, on/off, mm/inch
- Battery CR2032, automatic power off
- Meet DIN862
- Made of stainless steel



1541-150



Code	Range	Accuracy	L	a	d
1541-150	0-150mm/0-6"	±0.03mm	232.5mm	11mm	100mm
1541-200	0-200mm/0-8"	±0.03mm	285mm	11mm	100mm
1541-300	0-300mm/0-12"	±0.03mm	390mm	13.5mm	150mm

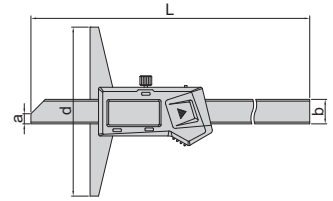
DIGITAL DEPTH GAGES (STANDARD TYPE)

DATA OUTPUT

- Buttons: on/off, zero, mm/inch
- Automatic power off, move the digital unit to turn on power
- Meet DIN862 (except 0-500mm/0-20", 0-1000mm/0-40", 0-1500mm/0-60")
- Battery CR2032
- Made of stainless steel



1141-150A



With data interface

Code	Range	Resolution	Accuracy	L	a	b	d	Data output cable (optional)
1141-150A	0-150mm/0-6"	0.01mm/0.0005"	±0.03mm	230mm	6mm	14.5mm	100mm	7315-21, 7302-21
1141-200A	0-200mm/0-8"	0.01mm/0.0005"	±0.03mm	280mm	6mm	14.5mm	100mm	7315-21, 7302-21
1141-300A	0-300mm/0-12"	0.01mm/0.0005"	±0.03mm	380mm	6mm	14.5mm	150mm	7315-21, 7302-21
1141-500A	0-500mm/0-20"	0.01mm/0.0005"	±0.05mm	585mm	7mm	15mm	150mm	7315-21, 7302-21
1141-5001A	0-500mm/0-20"	0.01mm/0.0005"	±0.05mm	585mm	7mm	15mm	200mm	7315-21, 7302-21
1141-1000A	0-1000mm/0-40"	0.01mm/0.0005"	±0.07mm	1188mm	7mm	18mm	150mm	7315-22, 7302-22
1141-10001A	0-1000mm/0-40"	0.01mm/0.0005"	±0.07mm	1188mm	7mm	18mm	200mm	7315-22, 7302-22
1141-10002A	0-1000mm/0-40"	0.01mm/0.0005"	±0.07mm	1188mm	7mm	18mm	250mm	7315-22, 7302-22
1141-10003A	0-1000mm/0-40"	0.01mm/0.0005"	±0.07mm	1188mm	7mm	18mm	300mm	7315-22, 7302-22
1141-1500A	0-1500mm/0-60"	0.01mm/0.0005"	±0.11mm	1695mm	7mm	18mm	200mm	7315-22, 7302-22

Built-in wireless

Code	Range	Resolution	Accuracy	L	a	b	d
1141-150AWL	0-150mm/0-6"	0.01mm/0.0005"	±0.03mm	230mm	6mm	14.5mm	100mm
1141-200AWL	0-200mm/0-8"	0.01mm/0.0005"	±0.03mm	280mm	6mm	14.5mm	100mm
1141-300AWL	0-300mm/0-12"	0.01mm/0.0005"	±0.03mm	380mm	6mm	14.5mm	150mm
1141-500AWL	0-500mm/0-20"	0.01mm/0.0005"	±0.05mm	585mm	7mm	15mm	150mm
1141-5001AWL	0-500mm/0-20"	0.01mm/0.0005"	±0.05mm	585mm	7mm	15mm	200mm

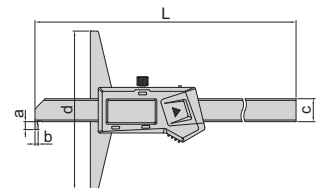
DIGITAL HOOK DEPTH GAGES

DATA OUTPUT

- Resolution: 0.01mm/0.0005"
- Buttons: on/off, zero, mm/inch
- Automatic power off, move the digital unit to turn on power
- Battery CR2032
- Made of stainless steel



1142-150A

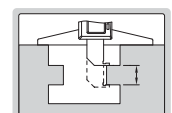
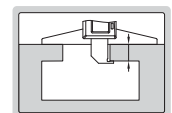
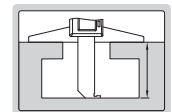


With data interface

Code	Range	Accuracy	L	d	a	b	c	Data output cable (optional)
1142-150A	0-150mm/0-6"	±0.03mm	230mm	100mm	5mm	2mm	14.5mm	7315-21, 7302-21
1142-200A	0-200mm/0-8"	±0.03mm	280mm	100mm	5mm	2mm	14.5mm	7315-21, 7302-21
1142-300A	0-300mm/0-12"	±0.04mm	380mm	150mm	5mm	2mm	14.5mm	7315-21, 7302-21
1142-500A	0-500mm/0-20"	±0.05mm	585mm	150mm	8mm	3mm	15mm	7315-21, 7302-21
1142-5001A	0-500mm/0-20"	±0.05mm	585mm	200mm	8mm	3mm	15mm	7315-21, 7302-21
1142-1000A	0-1000mm/0-40"	±0.07mm	1188mm	150mm	10mm	4mm	18mm	7315-22, 7302-22
1142-10001A	0-1000mm/0-40"	±0.07mm	1188mm	200mm	10mm	4mm	18mm	7315-22, 7302-22
1142-10002A	0-1000mm/0-40"	±0.07mm	1188mm	250mm	10mm	4mm	18mm	7315-22, 7302-22

Built-in wireless

Code	Range	Accuracy	L	d	a	b	c
1142-150AWL	0-150mm/0-6"	±0.03mm	230mm	100mm	5mm	2mm	14.5mm
1142-200AWL	0-200mm/0-8"	±0.03mm	280mm	100mm	5mm	2mm	14.5mm
1142-300AWL	0-300mm/0-12"	±0.04mm	380mm	150mm	5mm	2mm	14.5mm
1142-500AWL	0-500mm/0-20"	±0.05mm	585mm	150mm	8mm	3mm	15mm
1142-5001AWL	0-500mm/0-20"	±0.05mm	585mm	200mm	8mm	3mm	15mm

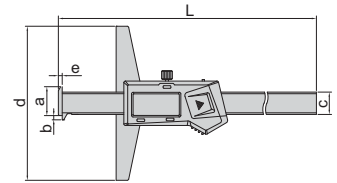


DATA OUTPUT

- Resolution: 0.01mm/0.0005"
- Buttons: on/off, zero, mm/inch
- Automatic power off, move the digital unit to turn on power
- Meet DIN862
- Battery CR2032
- Made of stainless steel

DIGITAL DOUBLE HOOK DEPTH GAGES

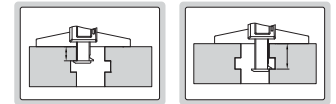
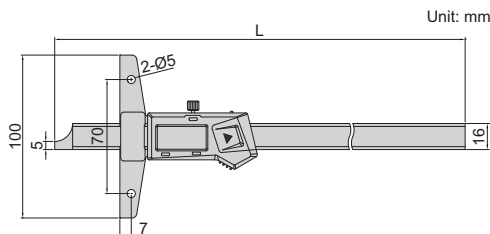

1144-150A


With data interface

Code	Range	Accuracy	L	d	a	b	c	e	Data output cable (optional)
1144-150A	0-150mm/0-6"	±0.03mm	233mm	100mm	21.5mm	3.5mm	14.5mm	2.5mm	7315-21, 7302-21
1144-200A	0-200mm/0-8"	±0.03mm	283mm	100mm	21.5mm	3.5mm	14.5mm	2.5mm	7315-21, 7302-21
1144-300A	0-300mm/0-12"	±0.03mm	383mm	150mm	21.5mm	3.5mm	14.5mm	2.5mm	7315-21, 7302-21
1144-500A	0-500mm/0-20"	±0.05mm	585mm	150mm	25mm	5mm	15mm	3mm	7315-21, 7302-21
1144-5001A	0-500mm/0-20"	±0.05mm	585mm	200mm	25mm	5mm	15mm	3mm	7315-21, 7302-21
1144-1000A	0-1000mm/0-40"	±0.07mm	1188mm	150mm	32mm	7mm	18mm	4mm	7315-22, 7302-22
1144-10001A	0-1000mm/0-40"	±0.07mm	1188mm	200mm	32mm	7mm	18mm	4mm	7315-22, 7302-22
1144-10002A	0-1000mm/0-40"	±0.07mm	1188mm	250mm	32mm	7mm	18mm	4mm	7315-22, 7302-22

Built-in wireless

Code	Range	Accuracy	L	d	a	b	c	e
1144-150AWL	0-150mm/0-6"	±0.03mm	233mm	100mm	21.5mm	3.5mm	14.5mm	2.5mm
1144-200AWL	0-200mm/0-8"	±0.03mm	283mm	100mm	21.5mm	3.5mm	14.5mm	2.5mm
1144-300AWL	0-300mm/0-12"	±0.03mm	383mm	150mm	21.5mm	3.5mm	14.5mm	2.5mm
1144-500AWL	0-500mm/0-20"	±0.05mm	585mm	150mm	25mm	5mm	15mm	3mm
1144-5001AWL	0-500mm/0-20"	±0.05mm	585mm	200mm	25mm	5mm	15mm	3mm


DATA OUTPUT
DIGITAL DEPTH GAGES WITH MOUNTING HOLES FOR EXTENSION BASE


1147-300

- Resolution: 0.01mm/0.0005"
- Buttons: on/off, zero, mm/inch
- Automatic power off, move the digital unit to turn on power
- Meet DIN862
- Battery CR2032
- Made of stainless steel
- Optional accessory: extension base (code 6141)

With data interface (data output cable code 7315-21, 7302-21, optional)

Code	Range	Accuracy	L (mm)
1147-150	0-150mm/0-6"	±0.03mm	237
1147-200	0-200mm/0-8"	±0.03mm	287
1147-300	0-300mm/0-12"	±0.03mm	403
1147-500	0-500mm/0-20"	±0.05mm	605

Built-in wireless

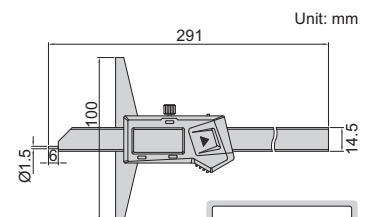
Code	Range	Accuracy	L (mm)
1147-150WL	0-150mm/0-6"	±0.03mm	237
1147-200WL	0-200mm/0-8"	±0.03mm	287
1147-300WL	0-300mm/0-12"	±0.03mm	403
1147-500WL	0-500mm/0-20"	±0.05mm	605

DATA OUTPUT
DIGITAL POINT DEPTH GAGES

- Resolution: 0.01mm/0.0005"
- Buttons: on/off, zero, mm/inch
- Automatic power off, move the digital unit to turn on power
- Meet DIN862
- Battery CR2032
- Made of stainless steel



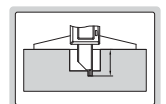
1143-200A


With data interface (data output cable code 7315-21, 7302-21, optional)

Code	Range	Accuracy
1143-200A	0-200mm/0-8"	±0.03mm

Built-in wireless

Code	Range	Accuracy
1143-200AWL	0-200mm/0-8"	±0.03mm



DIGITAL DEPTH GAGES WITH ROUND DEPTH BAR

MEASURE WIDTH AND DEPTH OF GROOVES INSIDE BORE

MEASURE DEPTH OF SMALL HOLES (>Ø4mm)

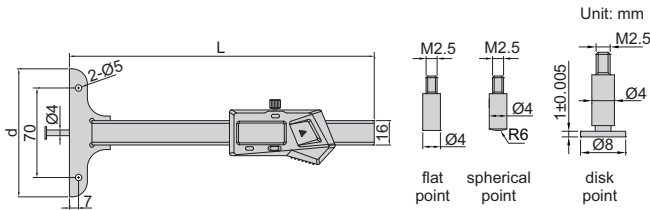
DATA OUTPUT

preset buttons



3

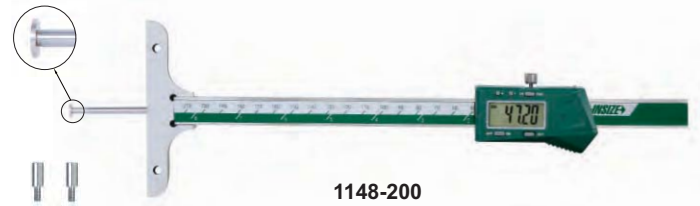
- Resolution: 0.01mm/0.0005"
- Supplied with three interchangeable points (flat, spherical, disk)
- Buttons: on/off, set, mm/inch, preset (+, -)
- Automatic power off, move the digital unit to turn on power
- Battery CR2032
- Made of stainless steel
- Optional accessory: extension base (code 6141, for 1148-120, 1148-120WL, 1148-200, 1148-200WL, 1148-300 and 1148-300WL)



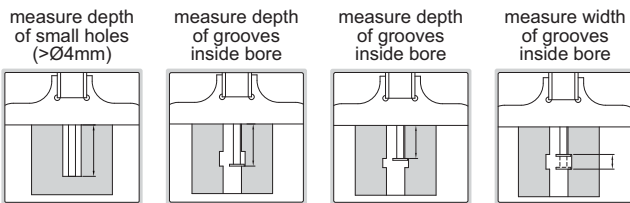
1148-100S



1148-120



1148-200



With data interface (data output cable code 7315-21, 7302-21, optional)

Code	Range *	Accuracy	L	d	Remark
1148-100S	0-100mm/0-4"	±0.02mm	200mm	45mm	
1148-100	0-100mm/0-4"	±0.02mm	200mm	85mm	
1148-120	0-120mm/0-4.7"	±0.03mm	300mm	101mm	one-hand use, with mounting holes for extension base
1148-200	0-200mm/0-8"	±0.03mm	300mm	101mm	with mounting holes for extension base
1148-300	0-300mm/0-12"	±0.04mm	400mm	101mm	with mounting holes for extension base

one-hand use of 1148-120 and 1148-120WL



extension base for 1148-120, 1148-120WL, 1148-200, 1148-200WL, 1148-300 and 1148-300WL (optional)



Built-in wireless

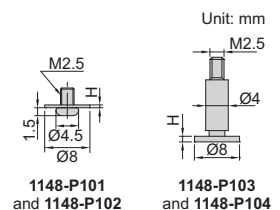
Code	Range *	Accuracy	L	d	Remark
1148-100SWL	0-100mm/0-4"	±0.02mm	200mm	45mm	
1148-100WL	0-100mm/0-4"	±0.02mm	200mm	85mm	
1148-120WL	0-120mm/0-4.7"	±0.03mm	300mm	101mm	one-hand use, with mounting holes for extension base
1148-200WL	0-200mm/0-8"	±0.03mm	300mm	101mm	with mounting holes for extension base
1148-300WL	0-300mm/0-12"	±0.04mm	400mm	101mm	with mounting holes for extension base

*When disk points are used, the range is reduced by 10mm

OPTIONAL DISK POINTS

Code	Description	H	Remark
1148-P101	0.5mm disk point	0.5±0.005mm	for narrow grooves
1148-P102	0.7mm disk point	0.7±0.005mm	for narrow grooves
1148-P103	1mm disk point	1±0.005mm	for grooves inside blind hole
1148-P104	0.5mm disk point	0.5±0.005mm	for grooves inside blind hole

1148-P101 (optional)



1148-P101 and 1148-P102

1148-P103 and 1148-P104

DATA OUTPUT

- Resolution: 0.01mm/0.0005"
- Buttons: on/off, zero, mm/inch, ABS/INC, data hold, TOL, set
- ABS/INC is for absolute and incremental measurement
- TOL is for tolerance measurement
- Made of stainless steel
- LR44 battery, data output
- Supplied with gage block for zero setting
- Optional accessory: extension base, data output cable (code **7302-SPC7**, keyboard format)

gage block for zero setting (included)



data output cable (optional)

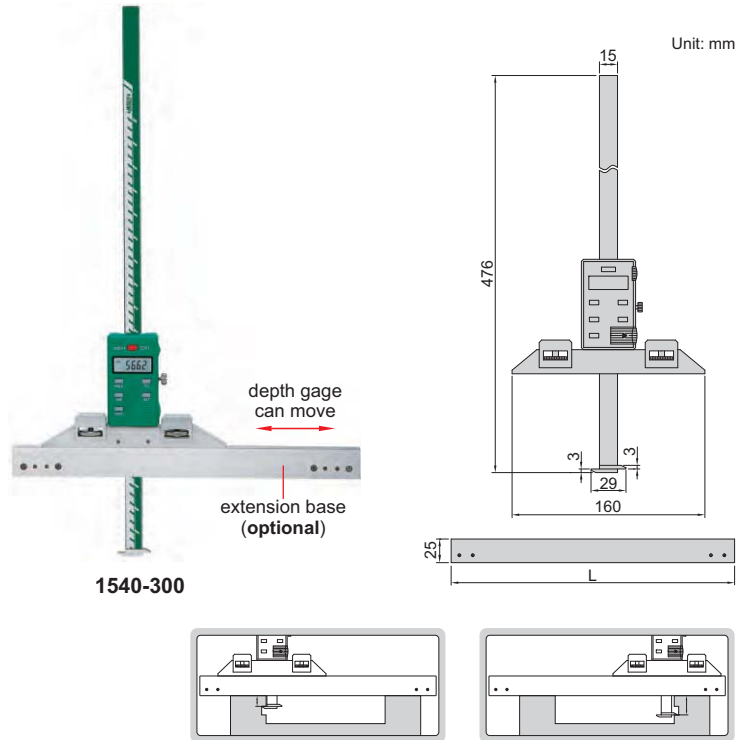


Extension base

Code	L
1540-L300	300mm
1540-L400	400mm
1540-L500	500mm
1540-L600	600mm
1540-L800	800mm

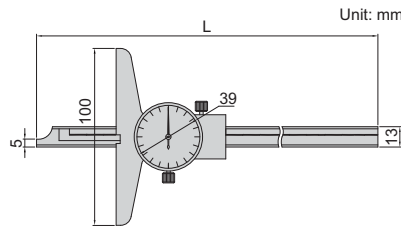
Code	Range	Accuracy
1540-300	0-300mm/0-12"	±0.04mm

DIGITAL DOUBLE HOOK DEPTH GAGE



SHOCK PROOF

- Shockproof dial indicator
- Made of stainless steel



DIAL DEPTH GAGES



Code	Range	Graduation	Accuracy	L
1340-150	0-150mm	0.02mm	±0.03mm	232mm
1340-200	0-200mm	0.02mm	±0.03mm	282mm
1340-300	0-300mm	0.02mm	±0.04mm	382mm

VERNIER DEPTH GAGES (STANDARD TYPE)

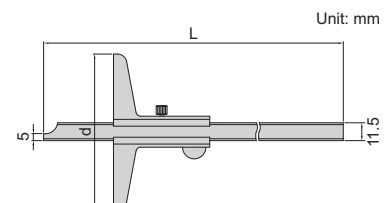
- Made of stainless steel
- Satin chrome plated reading surface

Graduation 0.05mm

Code	Range	Accuracy	L	d
1240-150	0-150mm	±0.05mm	245mm	100mm
1240-200	0-200mm	±0.05mm	282mm	100mm
1240-300	0-300mm	±0.08mm	382mm	100mm
1240-500	0-500mm	±0.09mm	585mm	150mm

Graduation 0.02mm

Code	Range	Accuracy	L	d
1240-1501	0-150mm	±0.03mm	245mm	100mm
1240-2001	0-200mm	±0.03mm	282mm	100mm
1240-3001	0-300mm	±0.04mm	382mm	100mm
1240-5001	0-500mm	±0.05mm	585mm	150mm

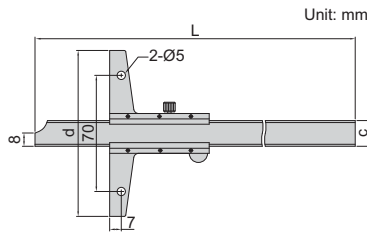


VERNIER DEPTH GAGES

WITH MOUNTING HOLES FOR EXTENSION BASE



- Made of stainless steel
- Satin chrome plating finish on reading surface
- Optional accessory: extension base (code **6141**)



1247-1501

Graduation 0.05mm

Code	Range	Accuracy
1247-150	0-150mm	±0.05mm
1247-200	0-200mm	±0.05mm
1247-300	0-300mm	±0.08mm
1247-600	0-600mm	±0.10mm
1247-1000	0-1000mm	±0.15mm

Graduation 0.02mm

Code	Range	Accuracy
1247-1501	0-150mm	±0.03mm
1247-2001	0-200mm	±0.03mm
1247-3001	0-300mm	±0.04mm
1247-6001	0-600mm	±0.05mm
1247-1001	0-1000mm	±0.07mm

Range	L	c	d
0-150mm	240mm	11mm	100mm
0-200mm	290mm	11mm	100mm
0-300mm	390mm	11mm	100mm
0-600mm	704mm	16mm	150mm
0-1000mm	1124mm	16mm	200mm

VERNIER DEPTH GAGES WITH FINE ADJUSTMENT

WITH MOUNTING HOLES FOR EXTENSION BASE

- With fine adjustment
- Made of stainless steel
- Satin chrome plating finish on reading surface
- Optional accessory: extension base (code **6141**)

Graduation 0.05mm

Code	Range	Accuracy
1249-150	0-150mm	±0.05mm
1249-200	0-200mm	±0.05mm
1249-300	0-300mm	±0.08mm

Graduation 0.02mm

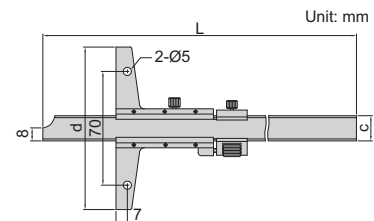
Code	Range	Accuracy
1249-1501	0-150mm	±0.03mm
1249-2001	0-200mm	±0.03mm
1249-3001	0-300mm	±0.04mm



Range	L	c	d
0-150mm	256mm	16mm	100mm
0-200mm	306mm	16mm	100mm
0-300mm	406mm	16mm	100mm



1249-1501



VERNIER HOOK DEPTH GAGES

WITH MOUNTING HOLES FOR EXTENSION BASE

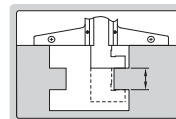
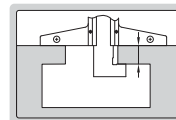
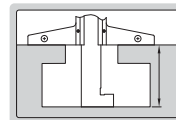
- Made of stainless steel
- Satin chrome plating finish on reading surface
- Optional accessory: extension base (code **6141**)

Graduation 0.05mm

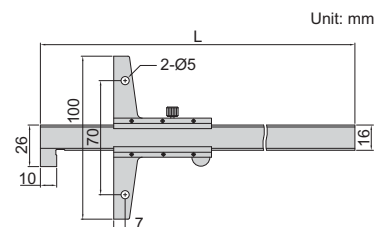
Code	Range	Accuracy	L
1248-150	0-150mm	±0.05mm	266mm
1248-200	0-200mm	±0.05mm	316mm
1248-300	0-300mm	±0.08mm	416mm

Graduation 0.02mm

Code	Range	Accuracy	L
1248-1501	0-150mm	±0.03mm	266mm
1248-2001	0-200mm	±0.03mm	316mm
1248-3001	0-300mm	±0.04mm	416mm

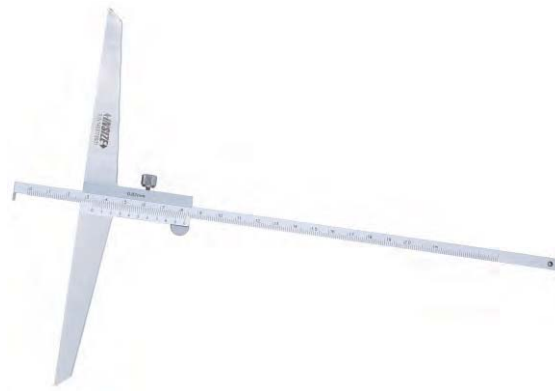


1248-1501

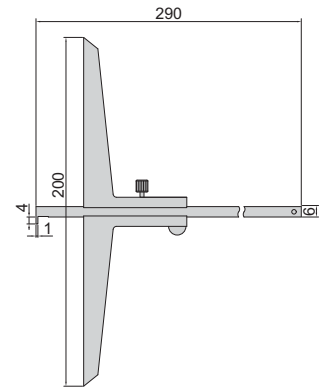


VERNIER HOOK DEPTH GAGE

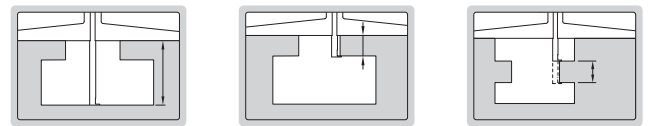
Unit: mm



1243-2001



- Graduation 0.02mm
- Made of stainless steel
- Satin chrome plating finish on reading surface

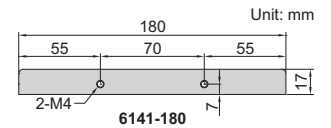


Code	Range	Accuracy
1243-2001	0-200mm	±0.03mm

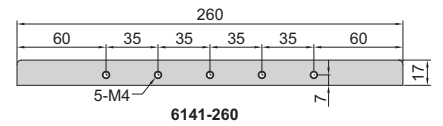
EXTENSION BASES



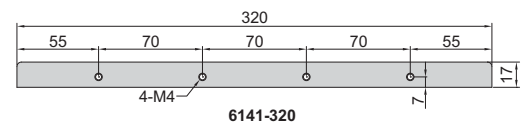
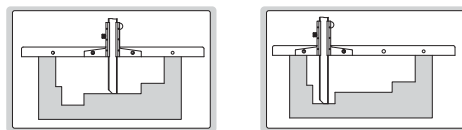
6141-260



- Supplied with two screws
- Made of stainless steel
- Suitable for depth gages series 1147, 1148, 1247, 1248 and 1249



Code	Length
6141-180	180mm
6141-260	260mm
6141-320	320mm



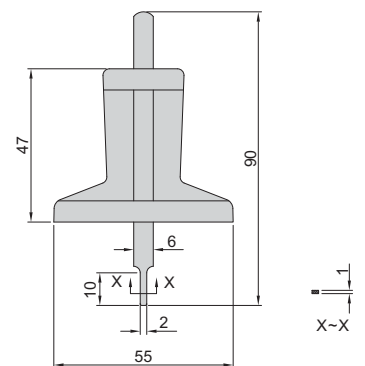
VERNIER DEPTH GAGE (ECONOMIC TYPE)

Unit: mm

- Graduation: 0.1mm
- Made of stainless steel



1244-30



Code	Range	Accuracy
1244-30	0-30mm	±0.10mm

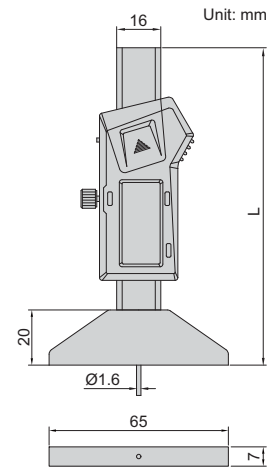
MINI DIGITAL DEPTH GAGES WITH ROUND BAR

DATA OUTPUT

3



1140-25



- Measure depth of small groove and hole
- Resolution: 0.01mm/0.0005"
- Buttons: on/off, set, mm/inch, preset (+,-)
- Automatic power off, move the digital unit to turn on power
- Battery CR2032
- Made of stainless steel

With data interface (data output cable code 7315-21, 7302-21, optional)

Code	Range	Accuracy	L
1140-25	0-25mm/0-1"	±0.02mm	114mm
1140-50	0-50mm/0-2"	±0.02mm	140mm

Built-in wireless

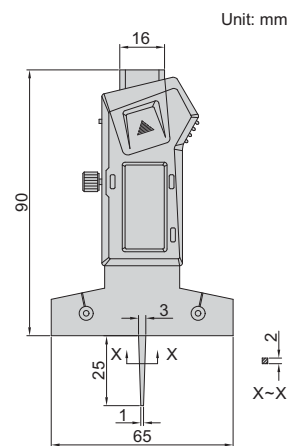
Code	Range	Accuracy	L
1140-25WL	0-25mm/0-1"	±0.02mm	114mm
1140-50WL	0-50mm/0-2"	±0.02mm	140mm

MINI DIGITAL DEPTH GAGES

DATA OUTPUT



1145-25A



- Measure depth of small groove and hole, also measure depth of tire tread
- Resolution: 0.01mm/0.0005"
- Buttons: on/off, zero, mm/inch
- Supplied with zero set surface
- Automatic power off, move the digital unit to turn on power
- Battery CR2032
- Made of stainless steel

With data interface (data output cable code 7315-21, 7302-21, optional)

Code	Range	Accuracy
1145-25A	0-25mm/0-1"	±0.03mm

Built-in wireless

Code	Range	Accuracy
1145-25AWL	0-25mm/0-1"	±0.03mm

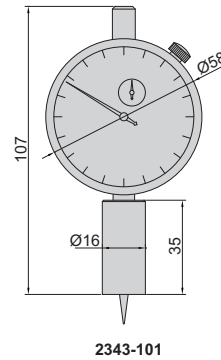
DIAL DEPTH GAGES

Unit: mm

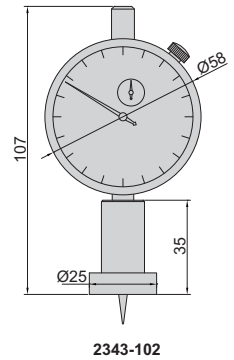
- Accuracy: $\pm 0.017\text{mm}$
- Stainless steel base
- Pointed tip



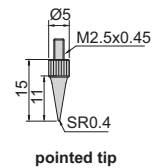
2343-102



2343-101



2343-102



pointed tip

Code	Range	Dial indicator stroke	Dial indicator graduation	Base
2343-101	0-10mm	10mm	0.01mm	$\varnothing 16\text{mm}$
2343-102	0-10mm	10mm	0.01mm	$\varnothing 25\text{mm}$

DATA OUTPUT

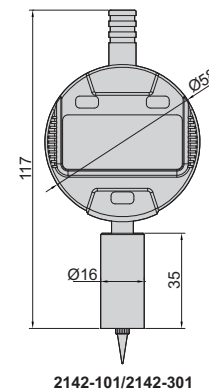
DIGITAL DEPTH GAGES

Unit: mm

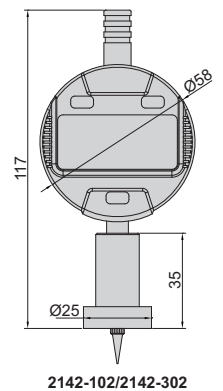
- Button function: on/off, zero, mm/inch, ABS, data preset, change measuring direction
- CR2032 battery, automatic power off
- Data output
- Stainless steel base
- Pointed tip
- Optional accessory: data output cable (code 7315-50M, 7302-40M)



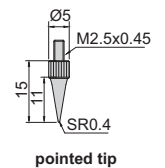
2142-102



2142-101/2142-301



2142-102/2142-302



pointed tip

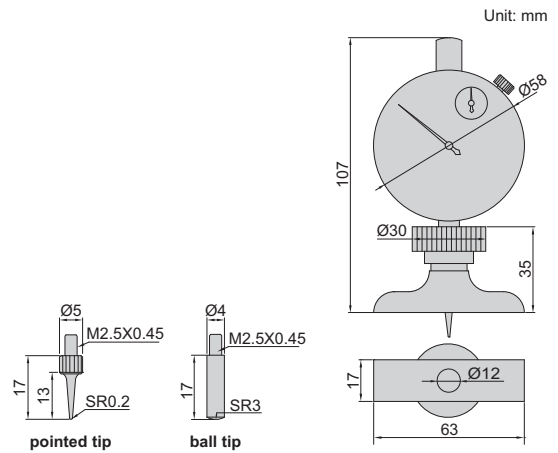
Code	Range	Digital indicator stroke	Digital indicator resolution	Accuracy	Base
2142-101	0-12.7mm/0-0.5"	12.7mm/0.5"	0.01mm/0.0005"	$\pm 20\mu\text{m}$	$\varnothing 16\text{mm}$
2142-102	0-12.7mm/0-0.5"	12.7mm/0.5"	0.01mm/0.0005"	$\pm 20\mu\text{m}$	$\varnothing 25\text{mm}$
2142-301	0-12.7mm/0-0.5"	12.7mm/0.5"	0.001mm/0.00005"	$\pm 5\mu\text{m}$	$\varnothing 16\text{mm}$
2142-302	0-12.7mm/0-0.5"	12.7mm/0.5"	0.001mm/0.00005"	$\pm 5\mu\text{m}$	$\varnothing 25\text{mm}$

DIAL DEPTH GAGE

- Accuracy: $\pm 0.017\text{mm}$
- Stainless steel base
- Supplied with pointed tip and ball tip



2341-101A



Code	Range	Dial indicator stroke	Dial indicator graduation
2341-101A	0-10mm	10mm	0.01mm

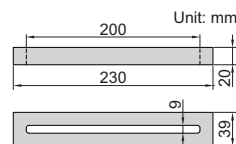
DIAL DEPTH GAGES



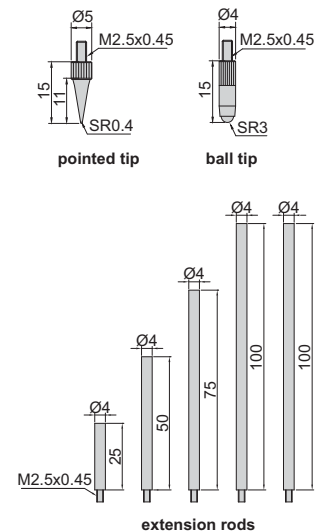
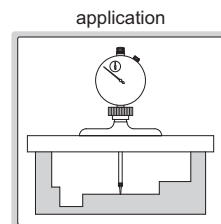
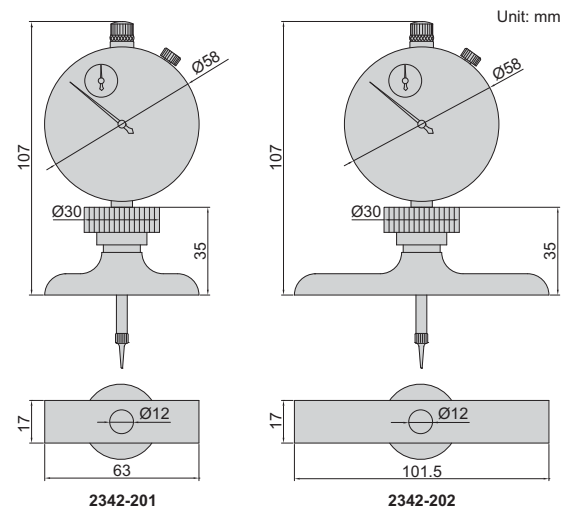
2342-202



2141-10 (optional), can be customized according to workpieces



- Dial indicator graduation: 0.01mm
- Accuracy: $\pm 0.03\text{mm}$
- Stainless steel base
- Extension rods: 25mm (1 pc), 50mm (1 pc), 75mm (1 pc), 100mm (2 pcs)
- Supplied with pointed tip and ball tip
- Optional accessory: granite extension holder (code 2141-10)



Code	Range	Dial indicator stroke	Base
2342-201	0-300mm	30mm	63x17mm
2342-202	0-300mm	30mm	101.5x17mm

DATA
OUTPUT

DIGITAL DEPTH GAGES

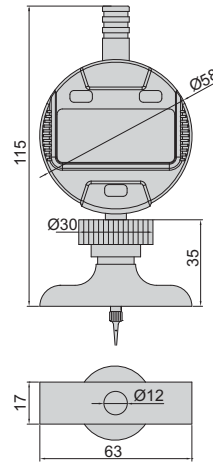
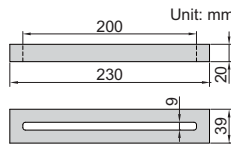
3



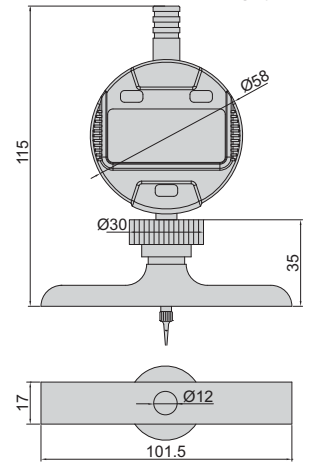
2141-202A



2141-10 (optional),
can be customized
according to workpieces



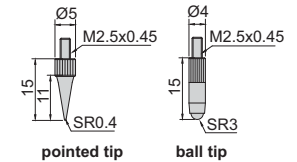
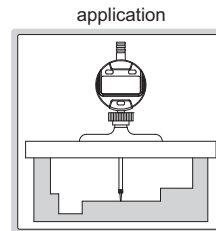
2141-201A/2141-301



2141-202A/2141-302

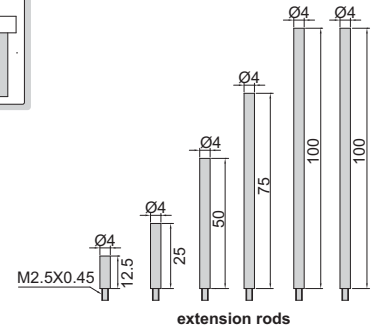
Unit: mm

- Button function: on/off, zero, mm/inch, ABS, data preset, change measuring direction
- CR2032 battery, automatic power off
- Data output
- Stainless steel base
- Extension rods: 12.5mm (1 pc), 25mm (1 pc), 50mm (1 pc), 75mm (1 pc), 100mm (2 pcs)
- Supplied with pointed tip and ball tip
- Optional accessory: data output cable (code **7315-50M**, **7302-40M**), granite extension holder (code **2141-10**)



pointed tip

ball tip



extension rods

Code	Range	Digital indicator stroke	Digital indicator resolution	Accuracy	Base
2141-201A	0-300mm/0-12"	12.7mm/0.5"	0.01mm/0.0005"	±20µm	63x17mm
2141-202A	0-300mm/0-12"	12.7mm/0.5"	0.01mm/0.0005"	±20µm	101.5x17mm
2141-301	0-300mm/0-12"	12.7mm/0.5"	0.001mm/0.00005"	±5µm	63x17mm
2141-302	0-300mm/0-12"	12.7mm/0.5"	0.001mm/0.00005"	±5µm	101.5x17mm

DATA
OUTPUT

DIGITAL DEPTH GAGE (60° KNIFE EDGE BASE)

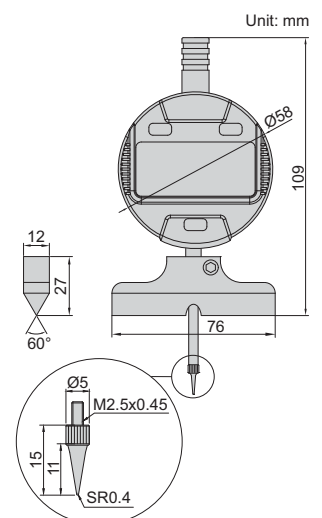
- Button function: on/off, zero, inch/mm, ABS, data preset, change measuring direction
- CR2032 battery, automatic power off
- Data output
- Stainless steel base with 60° knife edge
- Optional accessory: data output cable (code **7315-50M**, **7302-40M**)



front view

2143-101

side view



Unit: mm

Code	Range	Digital indicator stroke	Digital indicator resolution	Accuracy
2143-101	0-12.7mm/0-0.5"	12.7mm/0.5"	0.01mm/0.0005"	±20µm

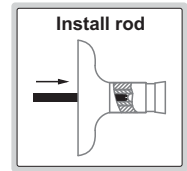
DIGITAL DEPTH MICROMETERS

IP65
WATERPROOF

DATA
OUTPUT

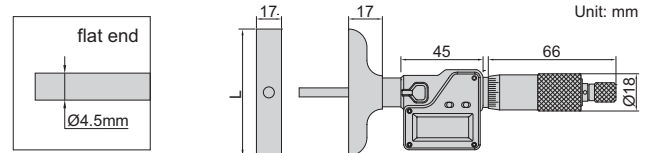
3

- Resolution: 0.001mm/0.00005"
- Micrometer head accuracy: $\pm 3\mu\text{m}$
- Rod accuracy: $\pm(2+L/75)\mu\text{m}$, L is the measuring range in mm
- Button function: on/off, set, mm/inch, ABS/INC
- IP65 dust/waterproof
- Data output
- LR44 battery, automatic power off
- Rods with flat end
- Ratchet stop
- Optional accessory: data output cable (code 7315-30, 7302-30)

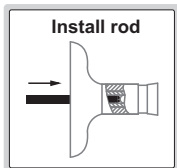


3540-50

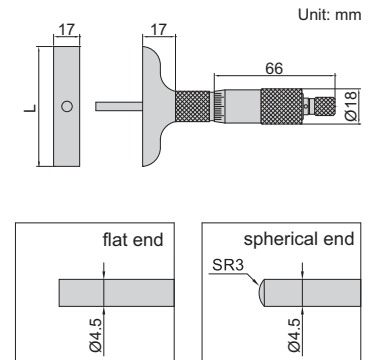
Code	Range	Rods	L
3540-25	0-25mm/0-1"	1 pc	101.5mm
3540-50	0-50mm/0-2"	2 pcs	101.5mm
3540-100	0-100mm/0-4"	4 pcs	101.5mm
3540-150	0-150mm/0-6"	6 pcs	101.5mm
3540-300	0-300mm/0-12"	12 pcs	101.5mm
3540-B25	0-25mm/0-1"	1 pc	63mm
3540-B50	0-50mm/0-2"	2 pcs	63mm
3540-B100	0-100mm/0-4"	4 pcs	63mm
3540-B150	0-150mm/0-6"	6 pcs	63mm
3540-B300	0-300mm/0-12"	12 pcs	63mm



DEPTH MICROMETERS



3240-100



- Meet DIN863-2
- Graduation: 0.01mm
- Micrometer head accuracy: $\pm 3\mu\text{m}$
- Rod accuracy: $\pm(2+L/75)\mu\text{m}$, L is the measuring range in mm
- Rods with flat or spherical end
- Ratchet stop

Flat end

Code	Range	Rods	L
3240-25	0-25mm	1 pc	101.5mm
3240-50	0-50mm	2 pcs	101.5mm
3240-75	0-75mm	3 pcs	101.5mm
3240-100	0-100mm	4 pcs	101.5mm
3240-150	0-150mm	6 pcs	101.5mm
3240-200	0-200mm	8 pcs	101.5mm
3240-300	0-300mm	12 pcs	101.5mm
3240-B25	0-25mm	1 pc	63mm
3240-B50	0-50mm	2 pcs	63mm
3240-B100	0-100mm	4 pcs	63mm
3240-B150	0-150mm	6 pcs	63mm
3240-B300	0-300mm	12 pcs	63mm

Spherical end

Code	Range	Rods	L
3240-25S	0-25mm	1 pc	101.5mm
3240-50S	0-50mm	2 pcs	101.5mm
3240-100S	0-100mm	4 pcs	101.5mm
3240-150S	0-150mm	6 pcs	101.5mm
3240-300S	0-300mm	12 pcs	101.5mm
3240-B25S	0-25mm	1 pc	63mm
3240-B50S	0-50mm	2 pcs	63mm
3240-B100S	0-100mm	4 pcs	63mm
3240-B150S	0-150mm	6 pcs	63mm
3240-B300S	0-300mm	12 pcs	63mm

DEPTH MICROMETERS

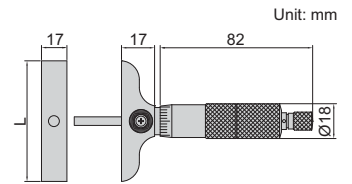
3
4

- Meet DIN863-2
- Graduation: 0.01mm
- Micrometer head accuracy: +/-3µm
- Rod accuracy: +/- (2+L/75)µm, L is the measuring range in mm
- Rods with flat end
- Ratchet stop

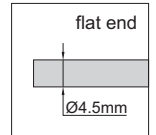
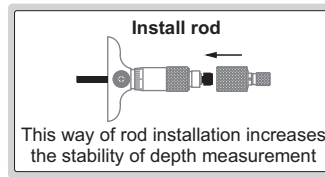
Code	Range	Rods	L
3241-25	0-25mm	1 pc	101.5mm
3241-50	0-50mm	2 pcs	101.5mm
3241-75	0-75mm	3 pcs	101.5mm
3241-100	0-100mm	4 pcs	101.5mm
3241-150	0-150mm	6 pcs	101.5mm
3241-200	0-200mm	8 pcs	101.5mm
3241-300	0-300mm	12 pcs	101.5mm
3241-B25	0-25mm	1 pc	63mm
3241-B50	0-50mm	2 pcs	63mm
3241-B100	0-100mm	4 pcs	63mm
3241-B150	0-150mm	6 pcs	63mm
3241-B300	0-300mm	12 pcs	63mm



3241-100



Unit: mm



HIGH PRECISION DIGITAL HEIGHT GAGES



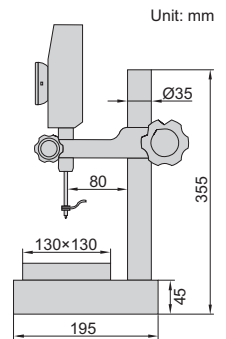
power supplied by charge pal



data transmitted to Excel without software; short press the foot switch to transmit data, long press to zero



1155-505



Unit: mm

- High stability, high precision, high response speed (5000mm/s)
- High brightness LED display
- Ceramic base flatness: 1µm

Code	Range	Resolution	Accuracy (20°C)	Measuring force	Output	Power supply
1155-505	0~50mm	0.5µm/0.00002" (can switch to: 1µm/0.00005")	1.5µm	1.0~1.5N	USB	5V/1A (adapter or charge pal)
1155-510	0~50mm	0.1µm/0.000005" (can switch to: 1µm/0.00005")	1µm	1.0~1.5N	USB	5V/1A (adapter or charge pal)

OPTIONAL ACCESSORY

Contact point	code 6282
Charge pal	1155-5-POB
Data output cables (including foot switch)	1155-5-FOS

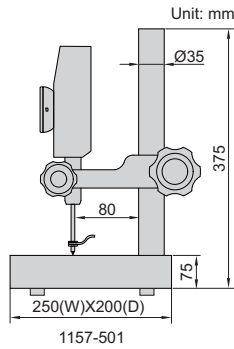
STANDARD DELIVERY

Main unit	1 pc
-----------	------

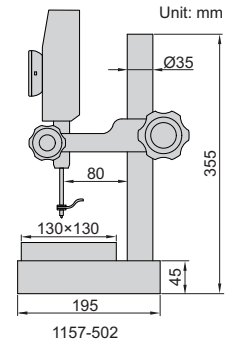
DIGITAL HEIGHT GAGES



1157-501



1157-502



- Buttons: on/off, zero, mm/inch, mix/min/mix-min
- High response speed (5000mm/s)
- High brightness LED display



power supplied by charge pal



foot switch

data transmitted to Excel without software; short press the foot switch to transmit data, long press to zero

Code	Range	Resolution	Accuracy (20°C)	Measuring force	Output	Power supply	Base
1157-501	0~50mm	1µm/0.00005"	3µm	1.0~1.5N	USB	5V/1A (adapter or charge pal)	granite (flatness: 2µm)
1157-502	0~50mm	1µm/0.00005"	3µm	1.0~1.5N	USB	5V/1A (adapter or charge pal)	ceramic (flatness: 1µm)

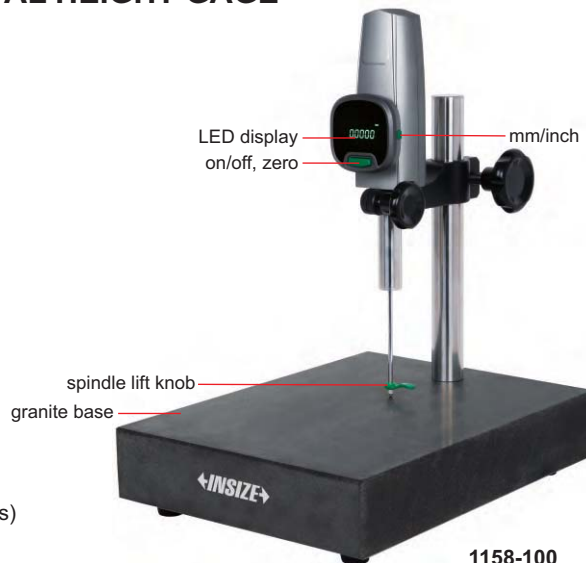
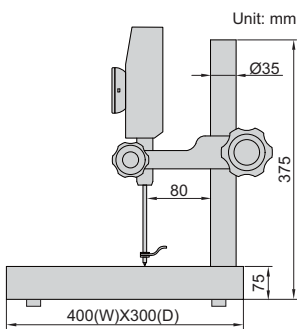
OPTIONAL ACCESSORY

Contact point	code 6282
Charge pal	1155-5-POB
Data output cables (including foot switch)	1155-5-FOS

STANDARD DELIVERY

Main unit	1 pc
-----------	------

LARGE RANGE DIGITAL HEIGHT GAGE



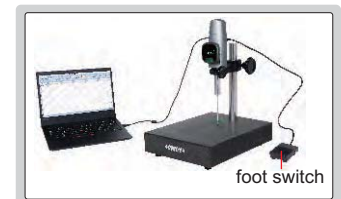
1158-100

- High stability, high precision, high response speed (5000mm/s)
- High brightness LED display
- Granite base flatness: 3µm

Code	Range	Resolution	Accuracy (20°C)	Measuring force	Output	Power supply
1158-100	0~100mm	0.1µm/0.000005" (can switch to: 1µm/0.00005")	3µm	1.0~1.5N	USB	5V/1A (adapter or charge pal)



power supplied by charge pal



foot switch

data transmitted to Excel without software; short press the foot switch to transmit data, long press to zero

STANDARD DELIVERY

Main unit	1 pc
-----------	------

OPTIONAL ACCESSORY

Contact point	code 6282
Charge pal	1155-5-POB
Data output cables (including foot switch)	1155-5-FOS

**INSPECTION
CERTIFICATE**

**DATA
OUTPUT**

1D MANUAL HEIGHT GAGE (WITHOUT AIR CUSHION) CODE DHG-C420

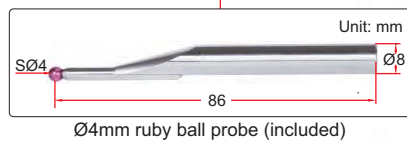
**INSIZE PLUS
MADE IN EUROPE**



software CD
(included)

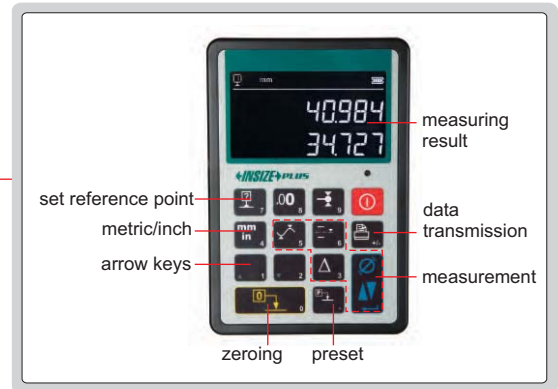


VIDEO

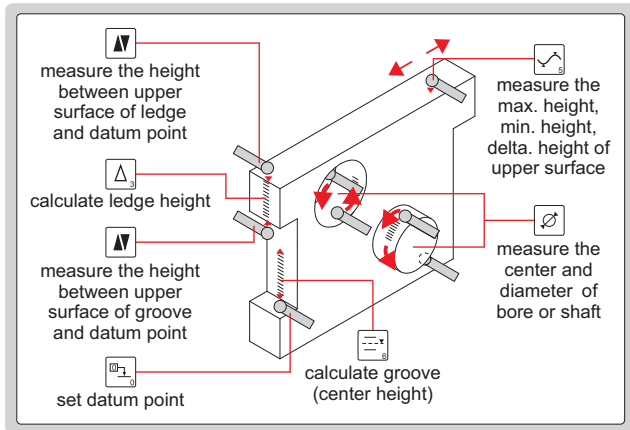


DHG-C420

- Set 9 reference points
- Probe can be moved quickly by hand
- Touch buttons
- LED display with backlight
- Built-in rechargeable battery, 40 hours working
- Measurement results can be sent to Excel/Word, equivalent to keyboard input



hand wheel



- measure height between measuring point and datum point
- maximum, minimum, TIR measurement
- calculate difference between two measured values
- measure diameter and center of shafts
- calculate average value of two measured values

SPECIFICATION

Measuring range	0~406mm
Accuracy (at 20°C)	8µm
Repeatability	3µm
Resolution	0.1mm, 0.01mm, 0.001mm (selectable)
Data output	USB
Measuring force	0.75N, 1N, 1.25N, 1.5N (selectable)
Power supply	rechargeable battery
Working temperature	10°C~40°C
Weight	21kg

STANDARD DELIVERY

Main unit	1 pc
Ø4mm ruby ball probe	1 pc
Calibration block	1 pc
AC/DC adapter	1 pc
Software and USB cable	1 pc

OPTIONAL ACCESSORY

Transmitter	7306-100
Receiver	7306-2
Probe	DHG-C-C2A DHG-C-C4A DHG-C-R4 DHG-C-R5B DHG-C-R10 DHG-C-P1

To be continued

Continued from previous page

■ Probe (optional) for DHG-C420

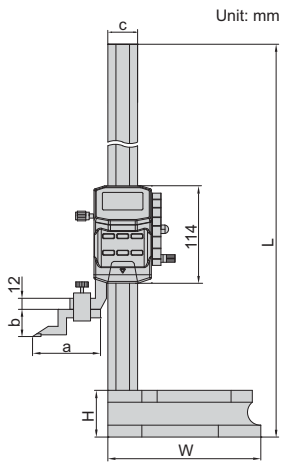
Unit: mm

<p>SØ2mm carbide ball probe, code DHG-C-C2A</p>	<p>SØ4mm carbide ball probe, code DHG-C-C4A</p>	<p>Ø1.5mm pin probe, code DHG-C-P1</p>
<p>SØ10mm ruby ball probe, code DHG-C-R10</p>	<p>SØ4mm ruby ball probe, code DHG-C-R4</p>	<p>SØ5mm ruby ball probe, code DHG-C-R5B</p>

DIGITAL HEIGHT GAGES WITH DRIVING WHEEL

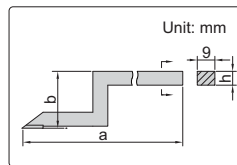
DATA
OUTPUT

INSPECTION
CERTIFICATE
TRACEABLE TO DKD



Unit: mm

scriber (included)



Unit: mm



1156-300

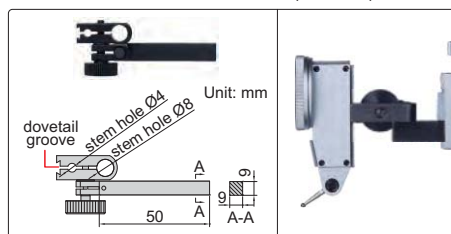
front

1156-1000

side

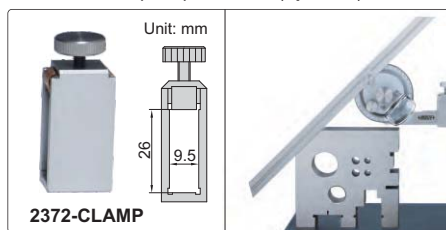
- Resolution: 0.01mm/0.0005"
- Buttons: on/off, zero, mm/inch, preset +, preset -, ABS/INC
- Automatic power off, move the digital unit to turn on power
- Carbide tipped scriber
- Made of stainless steel
- Battery CR2032
- Data output
- Supplied with dust cover
- With dial test indicator holder
- Optional accessory: data output cable (code **7315-22**, **7302-22**), clamp for protractors (code **2372-CLAMP**)

dial test indicator holder (included)



Unit: mm

clamp for protractors (optional)



Unit: mm

2372-CLAMP

Code	Range	Accuracy	L	W	H	a	b	c	h
1156-300*	0-300mm/0-12"	±0.03mm	515mm	180mm	55mm	80mm	30mm	35mm	9mm
1156-600*	0-600mm/0-24"	±0.05mm	815mm	180mm	55mm	80mm	30mm	35mm	9mm
1156-1000*	0-1000mm/0-40"	±0.07mm	1220mm	265mm	70mm	92mm	48mm	40mm	12mm

* Supplied with manufacturer inspection certificate traceable to DKD Germany

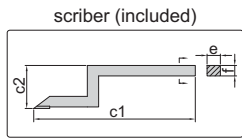
ATTENTION: CAN NOT USE CLAMP FOR PROTRACTORS (CODE 2372-CLAMP)

ATTENTION: LOW ACCURACY

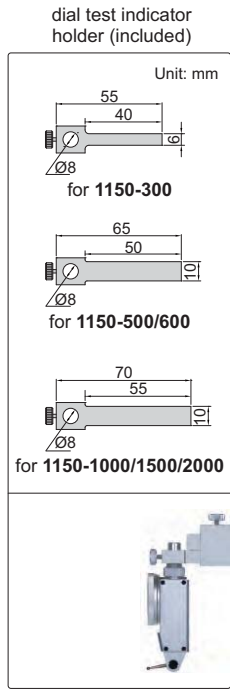
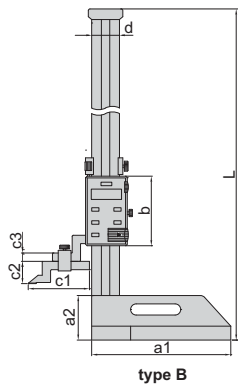
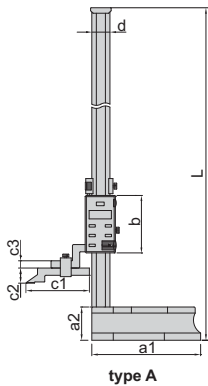
DATA OUTPUT

DIGITAL HEIGHT GAGES (ECONOMIC TYPE)

- Resolution: 0.01mm/0.0005"
- Buttons: on/off, zero, mm/inch, ABS/INC, data hold, TOL, set
- ABS/INC is for absolute and incremental measurement
- TOL is for tolerance measurement
- Carbide tipped scriber
- Made of stainless steel (except the base)
- LR44 battery, data output
- Supplied with dial test indicator holder
- Supplied with dust cover (except 1150-1500/2000)
- Optional accessory: data output cable (code 7302-SPC7, keyboard format)



data output cable (optional)



1150-1000



1150-500

Code	Range	Type	Accuracy	L	a1	a2	b	c1	c2	c3	d	e	f
1150-300	0-300mm/0-12"	A	±0.05mm	470mm	135mm	45mm	80mm	76mm	25mm	10mm	23mm	6mm	8mm
1150-500	0-500mm/0-20"	A	±0.06mm	720mm	180mm	55mm	95mm	103mm	25mm	12mm	30mm	10mm	12mm
1150-600	0-600mm/0-24"	A	±0.06mm	820mm	180mm	55mm	95mm	103mm	25mm	12mm	30mm	10mm	12mm
1150-1000	0-1000mm/0-40"	B	±0.08mm	1275mm	250mm	80mm	125mm	110mm	39mm	15mm	50mm	10mm	15mm
1150-1500	0-1500mm/0-60"	B	±0.12mm	1790mm	280mm	80mm	125mm	110mm	39mm	15mm	50mm	10mm	15mm
1150-2000	0-2000mm/0-80"	B	±0.16mm	2290mm	280mm	80mm	125mm	110mm	39mm	15mm	50mm	10mm	15mm

ATTENTION: CAN NOT USE CLAMP FOR PROTRACTORS (CODE 2372-CLAMP)

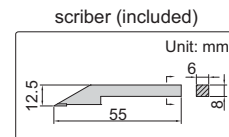
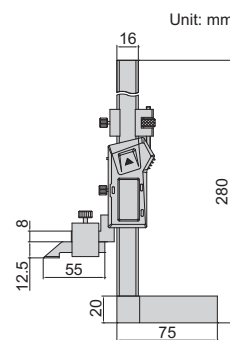
DATA OUTPUT

DIGITAL HEIGHT GAGES

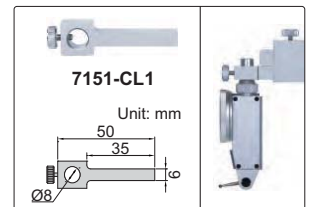
- Resolution: 0.01mm/0.0005"
- Buttons: on/off, zero, mm/inch
- Automatic power off, move the digital unit to turn on power
- Carbide tipped scriber
- With fine adjustment
- Made of stainless steel
- Battery CR2032
- Optional accessory: dial test indicator holder (code 7151-CL1)



1154-150



dial test indicator holder (optional)



With data interface (data output cable code 7315-21, 7302-21, optional)

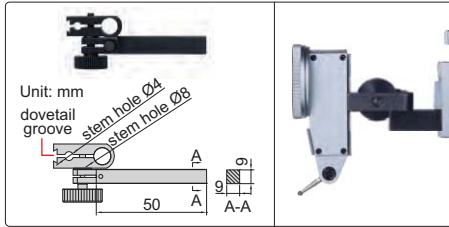
Code	Range	Accuracy
1154-150	0-150mm/0-6"	±0.03mm

Built-in wireless

Code	Range	Accuracy
1154-150WL	0-150mm/0-6"	±0.03mm

DIAL HEIGHT GAGES

dial test indicator holder (included)

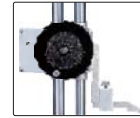
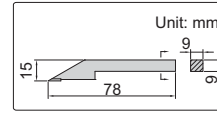


- Dial indicator graduation: 0.01mm
- One counter reads in the plus direction and another in the minus direction, so incremental measurement can be made in either direction
- Carbide tipped scriber
- Made of stainless steel (except the base)
- With driving wheel
- With dial test indicator holder
- Supplied with dust cover
- Optional accessory: clamp for protractors (code **2372-CLAMP**)



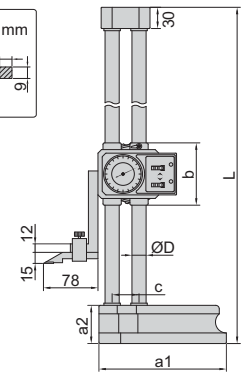
1351-300

scriber (included)



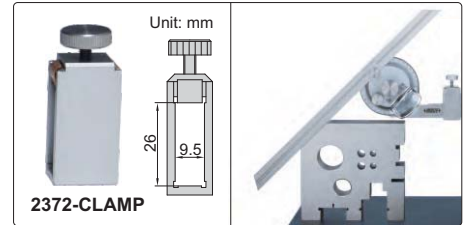
driving wheel on the back

Unit: mm



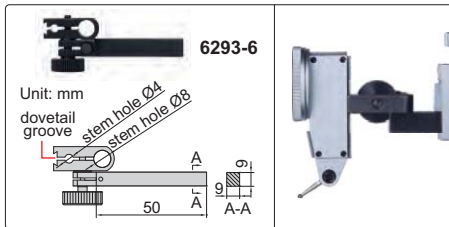
Code	Range	Accuracy	L	a1	a2	b	c	ØD
1351-300	0-300mm	±0.04mm	475	135	43	84	33	15
1351-450	0-450mm	±0.05mm	660	180	54	88	38	20
1351-600	0-600mm	±0.05mm	810	180	54	88	38	20

clamp for protractors (optional)



VERNIER HEIGHT GAGES

dial test indicator holder (optional)

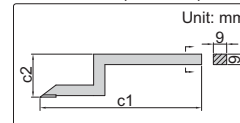


- Graduation: 0.02mm/0.001"
- Adjustable main scale to set zero
- Carbide tipped scriber
- Made of stainless steel (except the base)
- Satin chrome plated scale
- Supplied with magnifier
- With fine adjustment
- Supplied with dust cover
- Optional accessory: dial test indicator holder (code **6293-6**), clamp for protractors (code **2372-CLAMP**)

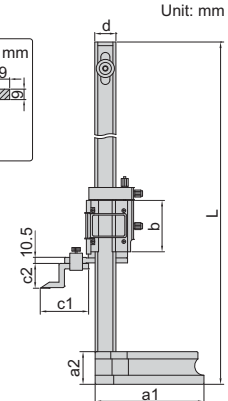


1250-300

scriber (included)

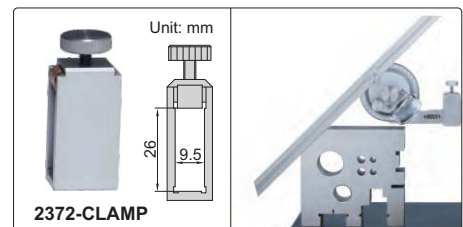


Unit: mm



Code	Range	Accuracy	L	a1	a2	b	c1	c2	d
1250-300	0-300mm/0-12"	±0.04mm	545	135	43	75	80	30	28
1250-450	0-450mm/0-18"	±0.05mm	720	180	54	85	80	41	35
1250-600	0-600mm/0-24"	±0.05mm	870	180	54	85	80	41	35

clamp for protractors (optional)

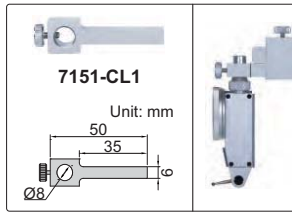


ATTENTION: CAN NOT USE CLAMP FOR PROTRACTORS (CODE 2372-CLAMP)

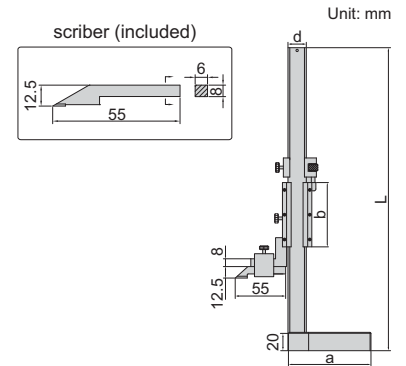
VERNIER HEIGHT GAGES

- Graduation 0.02mm/0.001"
- Carbide tipped scriber
- Made of stainless steel (except the base)
- Satin chrome plated scale
- Optional accessory: dial test indicator holder (code 7151-CL1)

dial test indicator holder (optional)



1253-200



Code	Range	Accuracy	L	a	b	d
1253-150	0-150mm/0-6"	±0.03mm	265	75	57	16
1253-200	0-200mm/0-8"	±0.03mm	325	90	70	20

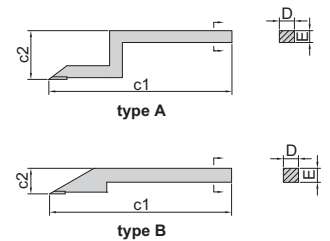
SCRIBERS FOR HEIGHT GAGES

- Carbide tipped



7150-SC1

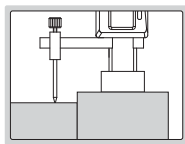
Code	For height gages	Type	c1	c2	D	E
7150-SC1	1150-300	A	76mm	25mm	6mm	8mm
7150-SC2	1150-500, 1150-600	A	103mm	25mm	10mm	12mm
7150-SC3	1150-1000, 1150-1500, 1150-2000	A	110mm	39mm	10mm	15mm
7150-SC4	1351-300, 1351-450, 1351-600	B	78mm	15mm	9mm	9mm
7150-SC6	1250-300, 1156-300, 1156-600	A	80mm	30mm	9mm	9mm
7150-SC7	1250-450, 1250-600	A	80mm	41mm	9mm	9mm
7150-SC9	1253-150, 1253-200, 1154-150	B	55mm	12.5mm	6mm	8mm
7150-SC10	1156-1000	A	92mm	48mm	9mm	12mm



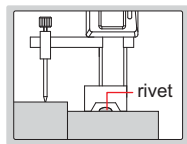
DATA OUTPUT

MINI DIGITAL HEIGHT GAGES

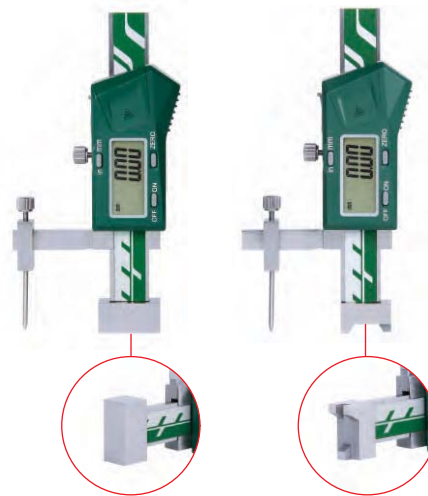
application of 1146-20A/1146-20AWL



application of 1146-20B/1146-20BWL

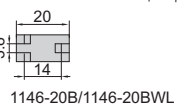
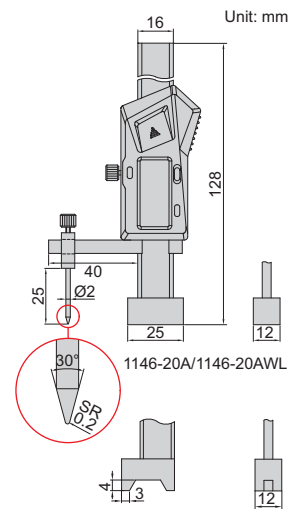


- Measure height difference of two surfaces (1146-20B, 1146-20BWL suitable for surfaces with barrier, such as rivet)
- Resolution: 0.01mm/0.0005"
- Buttons: on/off, zero, mm/inch
- Automatic power off, move the digital unit to turn on power
- Battery CR2032
- Made of stainless steel



1146-20A

1146-20B



With data interface (data output cable code 7315-21, 7302-21, optional)

Code	Range	Accuracy
1146-20A	0~±20mm/0~±0.8"	±0.02mm
1146-20B	0~±20mm/0~±0.8"	±0.02mm

Built-in wireless

Code	Range	Accuracy
1146-20AWL	0~±20mm/0~±0.8"	±0.02mm
1146-20BWL	0~±20mm/0~±0.8"	±0.02mm

HIGH PRECISION DIGITAL MICROMETERS/SNAP GAGES



NON-ROTATING SPINDLE

ABSOLUTE ENCODER, THE ORIGINAL DATA REMAINS AFTER POWER OFF

IP65 WATERPROOF

DATA OUTPUT

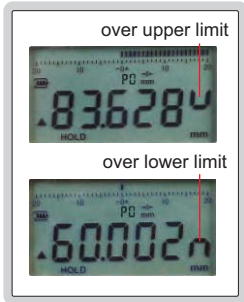
ONE TURN OF SLEEVE MAKES 5MM SPINDLE FEED, PRESS THE FORK, THE SPINDLE RETRACTS 3MM

MEASUREMENT ACCURACY IS NOT AFFECTED BY THE USE OF SLEEVE

ATTENTION: RECHARGEABLE BATTERY, FOR 24 HOURS CONTINUOUS WORKING

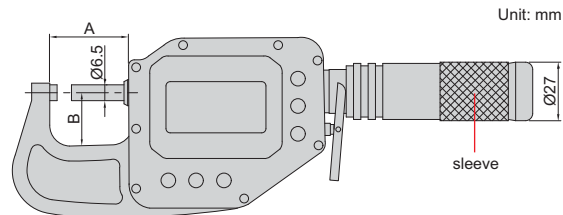
5

warning when over tolerance



3350-25

- Absolute encoder, the original data remains after power off
- Adjustable resolution: 0.0002mm/0.00001"
 - 0.001mm/0.00005"
 - 0.01mm/0.0005"
- One turn of sleeve makes 5mm spindle feed
- Measurement accuracy is not affected by the use of sleeve
- Press the fork, the spindle retracts 3mm
- Linear ball bearings for ten million times use
- Carbide spindle and anvil
- Measuring force 7-10N. Customizable measuring force range 2-12N. Attention: small measuring force will reduce the dustproof and waterproof level
- Button function: data output, tolerance, data preset, data hold, measuring direction change, max./min./TIR, power off time, on/off, zero, mm/inch, adjust resolution
- Supplied with gage blocks for zero setting
- Power: rechargeable battery, for 24 hours continuous working



With data interface

Optional accessory:

wireless transmitter, code **7315-60**, wireless receiver, code **7315-2**, **7315-3**

data output cable (keyboard format), code **7302-60**

data output cable (serial port format), code **7305-G60**

(cable length 3m, optional cable length maximum 15m; RS232 protocol, optional RS485 protocol)

Code	Range	Accuracy	Repeatability	Measuring faces		A	B
				Flatness	Parallelism		
3350-25 *	0-25mm/0-1"	1.4µm	0.6µm	0.5µm	1µm	38mm	24mm
3350-50 *	25-50mm/1-2"	1.6µm	1µm	0.5µm	1µm	63mm	28mm
3350-75 *	50-75mm/2-3"	1.8µm	1µm	0.5µm	1µm	88mm	45mm
3350-100 *	75-100mm/3-4"	2µm	1µm	0.5µm	1µm	113mm	57mm

Built-in wireless

Optional accessory:

wireless receiver (keyboard format), code **2134-R1**

wireless receiver (serial port format), code **2134-R2**

Code	Range	Accuracy	Repeatability	Measuring faces		A	B
				Flatness	Parallelism		
3350-25WL *	0-25mm/0-1"	1.4µm	0.6µm	0.5µm	1µm	38mm	24mm
3350-50WL *	25-50mm/1-2"	1.6µm	1µm	0.5µm	1µm	63mm	28mm
3350-75WL *	50-75mm/2-3"	1.8µm	1µm	0.5µm	1µm	88mm	45mm
3350-100WL *	75-100mm/3-4"	2µm	1µm	0.5µm	1µm	113mm	57mm

wireless receiver 2134-R1, 2134-R2 (optional)



* Supplied with manufacturer inspection certificate

QUICK MEASUREMENT
ONE TURN OF SLEEVE OR RATCHET STOP MAKES 2MM SPINDLE FEED

ATTENTION: SETTING STANDARDS ARE NOT INCLUDED

DATA OUTPUT

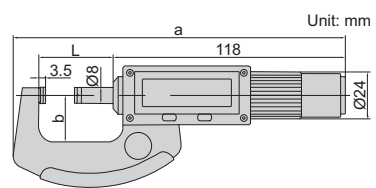
STROKE 30mm

IP65 WATERPROOF

NON-ROTATING SPINDLE

HIGH PRECISION NON-ROTATING SPINDLE DIGITAL MICROMETERS

INSIZE PLUS
MADE IN EUROPE



3661-30

Code	Range	Accuracy	L	a	b
3661-30	0-30mm/0-1.18"	±2µm	38	169	24
3661-55	25-55mm/0.98-2.17"	±2µm	63	195	30.5
3661-80	50-80mm/1.97-3.15"	±3µm	88	228	44
3661-105	75-105mm/2.95-4.13"	±3µm	113	257	57
3661-130	100-130mm/3.94-5.12"	±3µm	138	289	70
3661-155	125-155mm/4.92-6.1"	±3µm	163	315	83
3661-180	150-180mm/5.91-7.09"	±4µm	188	340	96
3661-205	175-205mm/6.89-8.07"	±4µm	213	363	109
3661-230	200-230mm/7.87-9.06"	±4µm	238	388	122
3661-255	225-255mm/8.86-10.04"	±4µm	268	429	135
3661-280	250-280mm/9.84-11.02"	±5µm	293	454	147.5
3661-305	275-305mm/10.83-12.01"	±5µm	318	479	160

- Resolution: 0.01mm/0.0005", 0.001mm/0.00005", 0.0005mm/0.00002"
- Repeatability: 0.5µm
- Measuring force: 5-10N
- Flatness of measuring faces: 0.3µm
- Parallelism of measuring faces: 0.5µm
- Ratchet stop
- Non-rotating spindle, suitable for cylinders
- Quick measurement: one turn of sleeve or ratchet stop makes 2mm spindle feed
- Carbide measuring faces
- Data output
- Button function: mm/inch, max./min. value tracking, preset value, hold, on/off, zero
- CR2032 battery
- Automatic power off, turn the sleeve to turn on
- Optional accessory: setting standards (code 7386), data output cable (code 7305-A03, 7305-SPC4)

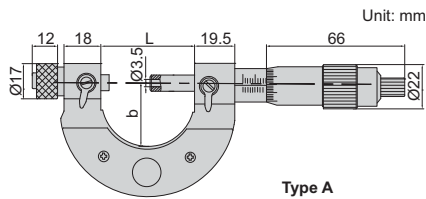
INSPECTION CERTIFICATE
TRACEABLE TO DKD

EXTERNAL SCREW THREAD MICROMETERS

INSIZE PLUS
MADE IN EUROPE

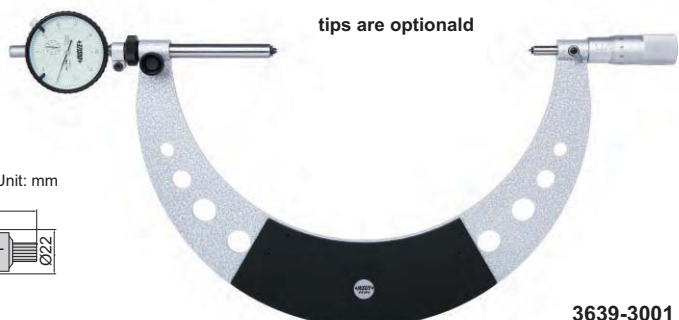


3639-25



Type A

dial indicator is optional

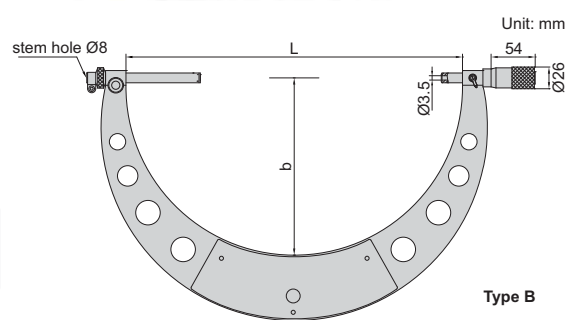


3639-3001

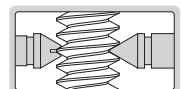
- Meet DIN863-3
- Measure pitch diameter of screw thread
- Graduation 0.01mm
- Optional accessory: measuring tips and setting standards for external screw thread micrometer (code 7384), dial indicators or digital indicators (reading 0.01mm or 0.001mm) (only for type B)

Type A (ratchet thimble)

Code	Range	Accuracy	L	b
3639-25*	0-25mm	4µm	45mm	31mm
3639-50*	25-50mm	4µm	70mm	35mm
3639-75*	50-75mm	5µm	95mm	48.5mm
3639-100*	75-100mm	5µm	120mm	60mm
3639-125*	100-125mm	6µm	145mm	72.5mm
3639-150*	125-150mm	6µm	170mm	80mm
3639-175*	150-175mm	7µm	195mm	97.5mm
3639-200*	175-200mm	7µm	220mm	110mm
3639-225*	200-225mm	8µm	245mm	122mm



Type B



Type B (without ratchet thimble)

Code	Range	Anvil retracting range	L	b
3639-2001*	100-200mm	3mm	217mm	109mm
3639-3001*	200-300mm	3mm	317mm	159mm
3639-4001*	300-400mm	3mm	417mm	209mm

* Supplied with manufacturer inspection certificate traceable to DKD Germany

MEASURING TIPS FOR EXTERNAL SCREW THREAD MICROMETERS

INSIZE PLUS
MADE IN EUROPE

TIPS FOR TRAPEZOIDAL, ACME
THREAD ARE ALSO AVAILABLE

ATTENTION: WHEN PITCH <0.4MM OR >63.5 TPI,
SETTING STANDARDS CANNOT BE USED TO SET ZERO,
A CALIBRATED WORK PIECE CAN BE USED INSTEAD

5

- Supplied in pair
- Made of hardened steel
- Suitable for 3639 series micrometers



7384-T108



60° thread angle

Code	Applicable pitch (mm)
7384-T101	0.2
7384-T102	0.225
7384-T103	0.25
7384-T104	0.3
7384-T105	0.35
7384-T106	0.4/0.45
7384-T107	0.5/0.6
7384-T108	0.7/0.75/0.8
7384-T109	1/1.25
7384-T110	1.5/1.75
7384-T111	2.0/2.5
7384-T112	3.0/3.5
7384-T113	4.0/4.5/5.0
7384-T114	5.5/6.0

55° thread angle

Code	Applicable pitch (TPI)
7384-T201	80
7384-T202	72/64
7384-T203	60/48
7384-T204	40/32
7384-T205	28/26/24/22
7384-T206	20/19/18/16
7384-T207	14/12/11
7384-T208	10/9/8
7384-T209	7/6
7384-T210	5/4.5/4
7384-T211	3.5/3.25/3/2.875/2.75
7384-T212	2.625/2.5/2

SETTING STANDARDS FOR EXTERNAL SCREW THREAD MICROMETERS



7384-A100



60° thread angle

Code	L	Ød	Accuracy (mm)
7384-A25	25	7.8	±1.5µm
7384-A50	50	7.8	±2µm
7384-A75	75	7.8	±2.5µm
7384-A100	100	7.8	±3µm
7384-A125	125	7.8	±3.5µm
7384-A150	150	7.8	±4µm
7384-A175	175	7.8	±4.5µm
7384-A200	200	7.8	±5µm
7384-A225	225	10	±5.5µm
7384-A250	250	10	±6µm
7384-A275	275	10	±6.5µm
7384-A300	300	10	±7µm

55° thread angle

Code	L	Ød	Accuracy (mm)
7384-B25	25	7.8	±1.5µm
7384-B50	50	7.8	±2µm
7384-B75	75	7.8	±2.5µm
7384-B100	100	7.8	±3µm
7384-B125	125	7.8	±3.5µm
7384-B150	150	7.8	±4µm
7384-B175	175	7.8	±4.5µm
7384-B200	200	7.8	±5µm
7384-B225	225	10	±5.5µm
7384-B250	250	10	±6µm
7384-B275	275	10	±6.5µm
7384-B300	300	10	±7µm

WATERPROOF DIGITAL OUTSIDE MICROMETERS (WITH DATA OUTPUT)

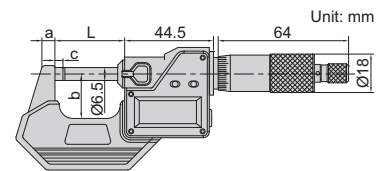
DATA
OUTPUT

IP65
WATERPROOF

- IP65 dust/waterproof
- Button function: on/off, set, mm/inch, ABS/INC
- Data output
- LR44 battery, automatic power off
- Carbide measuring faces
- Supplied with spherical anvil
- Setting standards are included (except 0-25mm/0-1")
- Optional accessory: data output cable (code 7315-30, 7302-30)



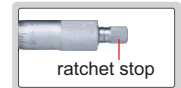
3101-25A



Metric/Inch type (ratchet stop)

(mm)

Code	Range	Resolution	Accuracy	L	a	b	c
3101-25A*	0-25mm/0-1"	0.001mm/0.00005"	±2µm	34.5	6	25	3
3101-50A*	25-50mm/1-2"	0.001mm/0.00005"	±2µm	59.5	8	32	3
3101-75A*	50-75mm/2-3"	0.001mm/0.00005"	±3µm	84.5	8	44.5	3
3101-100A*	75-100mm/3-4"	0.001mm/0.00005"	±3µm	109.5	8	57	3
3101-125A	100-125mm/4-5"	0.001mm/0.00005"	±3µm	135	10	70	3
3101-150A	125-150mm/5-6"	0.001mm/0.00005"	±3µm	160.5	10	82	3
3101-175A	150-175mm/6-7"	0.001mm/0.00005"	±4µm	186	12	94.5	5.5
3101-200A	175-200mm/7-8"	0.001mm/0.00005"	±4µm	211.5	12	107	5.5
3101-225A	200-225mm/8-9"	0.001mm/0.00005"	±4µm	236	23	129.5	5.5
3101-250A	225-250mm/9-10"	0.001mm/0.00005"	±4µm	261.5	23	142.5	5.5
3101-275A	250-275mm/10-11"	0.001mm/0.0001"	±5µm	287	23	155	5.5
3101-300A	275-300mm/11-12"	0.001mm/0.0001"	±5µm	312.5	23	167.5	5.5



Metric/Inch type (friction thimble)

(mm)

Code	Range	Resolution	Accuracy	L	a	b	c
3101-25FA*	0-25mm/0-1"	0.001mm/0.00005"	±2µm	34.5	6	25	3



Metric type (ratchet stop)

(mm)

Code	Range	Resolution	Accuracy	L	a	b	c
3101-25AJ*	0-25mm	0.001mm	±2µm	34.5	6	25	3
3101-50AJ*	25-50mm	0.001mm	±2µm	59.5	8	32	3
3101-75AJ*	50-75mm	0.001mm	±3µm	84.5	8	44.5	3
3101-100AJ*	75-100mm	0.001mm	±3µm	109.5	8	57	3

Set (ratchet stop type)

Code	Range	Micrometers included	Packaging
3101-753A*	0-75mm/0-3"	3101-25A, 3101-50A, 3101-75A	blow mould case
3101-1004A*	0-100mm/0-4"	3101-25A, 3101-50A, 3101-75A, 3101-100A	blow mould case
3101-1506A	0-150mm/0-6"	3101-25A, 3101-50A, 3101-75A, 3101-100A, 3101-125A, 3101-150A	aluminum box



3101-753A



3101-1506A

* Supplied with manufacturer inspection certificate traceable to DKD Germany

WATERPROOF DIGITAL OUTSIDE MICROMETERS (WITHOUT DATA OUTPUT)

- Resolution 0.001mm/0.00005"
- IP65 dust/waterproof
- Button function: on/off, set, mm/inch, ABS/INC
- No data output
- LR44 battery, automatic power off
- Carbide measuring faces
- Supplied with spherical anvil
- Setting standards are included (except 0-25mm/0-1")

IP65
WATERPROOF

ATTENTION: NO
DATA OUTPUT

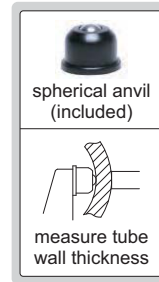
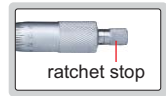
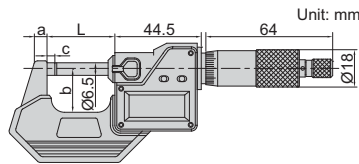
INSPECTION
CERTIFICATE
TRACEABLE TO DKD

Ratchet stop type

Code	Range	Accuracy	L	a	b	c
3108-25A*	0-25mm/0-1"	±2µm	34.5	6	25	3
3108-50A*	25-50mm/1-2"	±2µm	59.5	8	32	3
3108-75A*	50-75mm/2-3"	±3µm	84.5	8	44.5	3
3108-100A*	75-100mm/3-4"	±3µm	109.5	8	57	3
3108-125A	100-125mm/4-5"	±3µm	135	10	70	3
3108-150A	125-150mm/5-6"	±3µm	160.5	10	82	3
3108-175A	150-175mm/6-7"	±4µm	186	12	94.5	5.5
3108-200A	175-200mm/7-8"	±4µm	211.5	12	107	5.5



3108-25A



Friction thimble type

Code	Range	Accuracy	L	a	b	c
3108-25FA*	0-25mm/0-1"	±2µm	34.5	6	25	3

Set

Code	Range	Micrometers included	Packaging
3108-753A*	0-75mm/0-3"	3108-25A, 3108-50A, 3108-75A	blow mould case
3108-1004A*	0-100mm/0-4"	3108-25A, 3108-50A, 3108-75A, 3108-100A	blow mould case
3108-1506A	0-150mm/0-6"	3108-25A, 3108-50A, 3108-75A, 3108-100A, 3108-125A, 3108-150A	aluminum box



3108-753A



3108-1506A

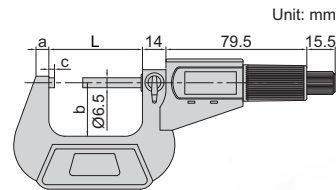
*Supplied with manufacturer inspection certificate traceable to DKD Germany

DIGITAL OUTSIDE MICROMETERS (BASIC TYPE, WITH DATA OUTPUT)

- Resolution 0.001mm/0.00005"
- Button function: on/off, set, mm/inch, ABS/INC
- Data output
- LR44 battery, automatic power off
- Carbide measuring faces
- Friction thimble
- Supplied with spherical anvil
- Setting standards are included (except 0-25mm/0-1")
- Optional accessory: data output cable

INSPECTION
CERTIFICATE
TRACEABLE TO DKD

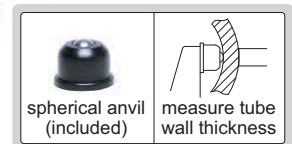
DATA
OUTPUT



data output on the back



3102-50



Code	Range	Accuracy	L	a	b	c
3102-25*	0-25mm/0-1"	±2µm	32	6	24	3
3102-50*	25-50mm/1-2"	±2µm	57	8	32	3
3102-75*	50-75mm/2-3"	±3µm	82	8	45	3
3102-100*	75-100mm/3-4"	±3µm	107	10	57	3
3102-125	100-125mm/4-5"	±3µm	133	10	70	3
3102-150	125-150mm/5-6"	±3µm	158	10	82	3
3102-175	150-175mm/6-7"	±4µm	183	12	95	5.5
3102-200	175-200mm/7-8"	±4µm	209	12	107	5.5

Set

Code	Range	Micrometers included	Packaging
3102-753A*	0-75mm/0-3"	3102-25, 3102-50, 3102-75	blow mould case
3102-1004A*	0-100mm/0-4"	3102-25, 3102-50, 3102-75, 3102-100	blow mould case
3102-1506A	0-150mm/0-6"	3102-25, 3102-50, 3102-75, 3102-100, 3102-125, 3102-150	aluminum box



3102-753A



3102-1506A

*Supplied with manufacturer inspection certificate traceable to DKD Germany



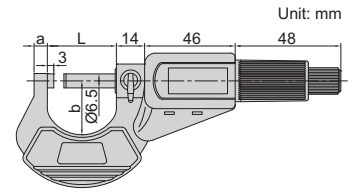
DIGITAL OUTSIDE MICROMETERS (BASIC TYPE, WITHOUT DATA OUTPUT)

ATTENTION: NO DATA OUTPUT

- Resolution 0.001mm/0.00005"
- Button function: on/off, set, mm/inch, ABS/INC
- No data output
- LR44 battery, automatic power off
- Carbide measuring faces
- Friction thimble
- Supplied with spherical anvil
- Setting standards are included (except 0-25mm/0-1")



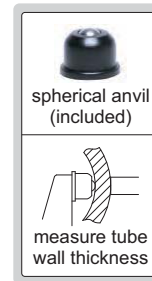
3109-25A



Code	Range	Accuracy	L	a	b
3109-25A*	0-25mm/0-1"	±2µm	32mm	6mm	27.5mm
3109-50A*	25-50mm/1-2"	±2µm	57mm	8mm	37mm
3109-75A*	50-75mm/2-3"	±3µm	82mm	8mm	50mm
3109-100A*	75-100mm/3-4"	±3µm	107mm	10mm	61mm
3109-125A	100-125mm/4-5"	±3µm	132mm	10mm	73mm
3109-150A	125-150mm/5-6"	±3µm	157mm	10mm	85mm
3109-175A	150-175mm/6-7"	±4µm	182mm	21mm	104mm
3109-200A	175-200mm/7-8"	±4µm	207mm	21mm	117mm

Set

Code	Range	Micrometers included	Packaging
3109-753A*	0-75mm/0-3"	3109-25A, 3109-50A, 3109-75A	blow mould case
3109-1004A*	0-100mm/0-4"	3109-25A, 3109-50A, 3109-75A, 3109-100A	blow mould case
3109-1506A	0-150mm/0-6"	3109-25A, 3109-50A, 3109-75A, 3109-100A, 3109-125A, 3109-150A	aluminum box



3109-753A



3109-1506A

*Supplied with manufacturer inspection certificate traceable to DKD Germany



DATA OUTPUT

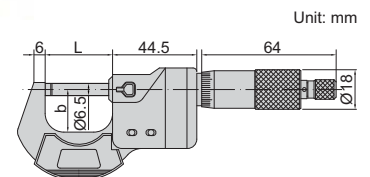
IP65 WATERPROOF

DIGITAL VERTICAL MICROMETERS

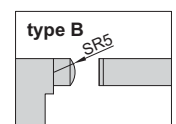
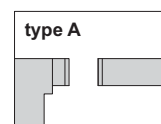
- Measure the thickness of plates for easy reading
- Resolution 0.001mm/0.00005"
- IP65 dust/waterproof
- Button function: on/off, set, mm/inch, ABS/INC
- Data output
- LR44 battery, automatic power off
- Carbide spindle tip
- Ratchet stop
- Supplied with setting standards (except 0-25mm/0-1")
- Optional accessory: data output cable (code 7315-30, 7302-30)



3565-25A



Code	Range	Type	Accuracy	L	b
3565-25A*	0-25mm/0-1"	A	±2µm	34.5mm	25mm
3565-50A*	25-50mm/1-2"	A	±2µm	59.5mm	32mm
3565-25BA*	0-25mm/0-1"	B	±2µm	34.5mm	25mm
3565-50BA*	25-50mm/1-2"	B	±2µm	59.5mm	32mm



*Supplied with manufacturer inspection certificate traceable to DKD Germany

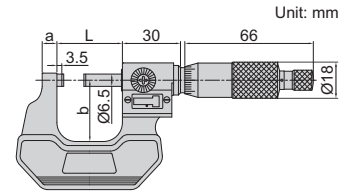
OUTSIDE MICROMETERS WITH COUNTER

- Counter resolution: 0.01mm
- Thimble graduation: 0.01mm
- Carbide measuring faces
- Meet DIN 863-1
- Ratchet stop
- Supplied with setting standards (except 0-25mm)

**INSPECTION
CERTIFICATE**
TRACEABLE TO DKD



3400-25



5

Code	Range	Accuracy	L	a	b
3400-25*	0-25mm	4µm	32mm	6mm	26mm
3400-50*	25-50mm	4µm	57mm	8mm	32mm
3400-75*	50-75mm	5µm	82mm	8mm	44.5mm
3400-100*	75-100mm	5µm	107mm	8mm	57mm

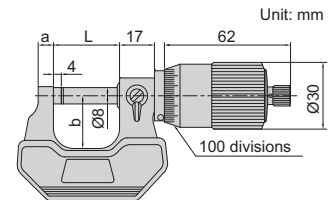
*Supplied with manufacturer inspection certificate traceable to DKD Germany

QUICK FEEDING OUTSIDE MICROMETERS

- Graduation 0.01mm
- 1mm feeding of each turn
- Friction thimble
- Carbide measuring faces
- Meet DIN863-1
- Supplied with setting standards (except 0-25mm)



3208-25B



Code	Range	Accuracy	L	a	b
3208-25B	0-25mm	4µm	32mm	6mm	24mm
3208-50B	25-50mm	4µm	57mm	8mm	32mm
3208-75B	50-75mm	5µm	82mm	8mm	45mm
3208-100B	75-100mm	5µm	107mm	8mm	57mm
3208-125B	100-125mm	6µm	133mm	8mm	70mm
3208-150B	125-150mm	6µm	158mm	8mm	82mm
3208-175B	150-175mm	7µm	183mm	8mm	95mm
3208-200B	175-200mm	7µm	209mm	8mm	107mm

OUTSIDE MICROMETERS

**INSPECTION
CERTIFICATE**
TRACEABLE TO DKD

Code	Range	Accuracy	L	a	b
3202-25A*	0-25mm	4µm	32mm	6mm	24mm
3202-50A*	25-50mm	4µm	57mm	8mm	32mm
3202-75A*	50-75mm	5µm	82mm	8mm	45mm
3202-100A*	75-100mm	5µm	107mm	8mm	57mm
3202-125A	100-125mm	6µm	133mm	8mm	70mm
3202-150A	125-150mm	6µm	125mm	8mm	82mm
3202-175A	150-175mm	7µm	183mm	8mm	95mm
3202-200A	175-200mm	7µm	209mm	8mm	107mm

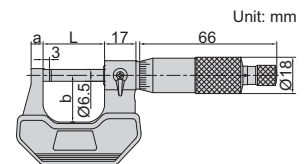
Micrometer set

Code	Range	Micrometers included
3202-753A*	0-75mm	3202-25A, 3202-50A, 3202-75A
3202-1004A*	0-100mm	3202-25A, 3202-50A, 3202-75A, 3202-100A
3202-1506A	0-150mm	3202-25A, 3202-50A, 3202-75A, 3202-100A, 3202-125A, 3202-150A

*Supplied with manufacturer inspection certificate traceable to DKD Germany



3202-25A



- Graduation 0.01mm
- Carbide measuring faces
- Meet DIN863-1
- Supplied with setting standards (except 0-25mm)

OUTSIDE MICROMETERS



3203-25A



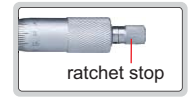
3203-50A



3203-1004A

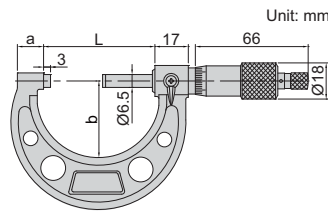


3203-3006A



5

- Graduation: metric 0.01mm
inch 0.0001"
- Carbide measuring faces
- Meet DIN863-1
- Supplied with setting standards (except 0-25mm and 0-1")



Metric (ratchet stop type)

Code	Range	Accuracy	L	a	b
3203-25A*	0-25mm	±2µm	32mm	9mm	28mm
3203-50A*	25-50mm	±2µm	57mm	14mm	38mm
3203-75A*	50-75mm	±2µm	82mm	15mm	49mm
3203-100A*	75-100mm	±3µm	107mm	15mm	60mm
3203-125A	100-125mm	±3µm	133mm	16.5mm	73mm
3203-150A	125-150mm	±3µm	158mm	16.5mm	85mm
3203-175A	150-175mm	±4µm	183mm	19.4mm	104mm
3203-200A	175-200mm	±4µm	209mm	19.4mm	117mm
3203-225A	200-225mm	±4µm	234mm	19.4mm	130mm
3203-250A	225-250mm	±5µm	260mm	19.4mm	142mm
3203-275A	250-275mm	±5µm	285mm	19.4mm	155mm
3203-300A	275-300mm	±5µm	310mm	19.4mm	168mm

Inch (ratchet stop type)

Code	Range	Accuracy	L	a	b
3203-1A*	0-1"	±.0001"	1.260"	.354"	1.102"
3203-2A*	1-2"	±.0001"	2.244"	.551"	1.496"
3203-3A*	2-3"	±.0001"	3.228"	.591"	1.929"
3203-4A*	3-4"	±.00015"	4.213"	.591"	2.362"
3203-5A*	4-5"	±.00015"	5.236"	.650"	2.874"
3203-6A*	5-6"	±.00015"	6.220"	.650"	3.346"
3203-7A	6-7"	±.0002"	7.205"	.764"	4.094"
3203-8A	7-8"	±.0002"	8.228"	.764"	4.606"
3203-9A	8-9"	±.0002"	9.213"	.764"	5.118"
3203-10A	9-10"	±.00025"	10.236"	.764"	5.591"
3203-11A	10-11"	±.00025"	11.220"	.764"	6.102"
3203-12A	11-12"	±.00025"	12.205"	.764"	6.614"

Metric micrometer set (ratchet stop type)

Code	Range	Micrometers Included	Packaging
3203-753A*	0-75mm	3203-25A, 3203-50A, 3203-75A	blow mould case
3203-1004A*	0-100mm	3203-25A, 3203-50A, 3203-75A, 3203-100A	blow mould case
3203-1506A	0-150mm	3203-25A, 3203-50A, 3203-75A, 3203-100A, 3203-125A, 3203-150A	blow mould case
3203-3006A	150-300mm	3203-175A, 3203-200A, 3203-225A, 3203-250A, 3203-275A, 3203-300A	aluminum box
3203-3012A	0-300mm	3203-25A, 3203-50A, 3203-75A, 3203-100A, 3203-125A, 3203-150A, 3203-175A, 3203-200A, 3203-225A, 3203-250A, 3203-275A, 3203-300A	aluminum box

Inch micrometer set (ratchet stop type)

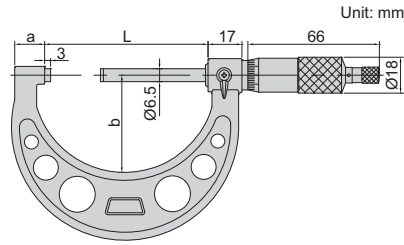
Code	Range	Micrometers included	Packaging
3203-33A*	0-3"	3203-1A, 3203-2A, 3203-3A	blow mould case
3203-44A*	0-4"	3203-1A, 3203-2A, 3203-3A, 3203-4A	blow mould case
3203-66A*	0-6"	3203-1A, 3203-2A, 3203-3A, 3203-4A, 3203-5A, 3203-6A	blow mould case
3203-126A	6-12"	3203-7A, 3203-8A, 3203-9A, 3203-10A, 3203-11A, 3203-12A	aluminum box
3203-1212A	0-12"	3203-1A, 3203-2A, 3203-3A, 3203-4A, 3203-5A, 3203-6A, 3203-7A, 3203-8A, 3203-9A, 3203-10A, 3203-11A, 3203-12A	aluminum box

Inch (friction thimble type)

Code	Range	Accuracy	L	a	b
3203-1FA*	0-1"	±.0001"	1.260"	.354"	1.102"
3203-2FA*	1-2"	±.0001"	2.244"	.551"	1.496"
3203-3FA*	2-3"	±.0001"	2.244"	.591"	1.929"

* Supplied with manufacturer inspection certificate traceable to DKD Germany or NIST USA

LONG SPINDLE OUTSIDE MICROMETERS

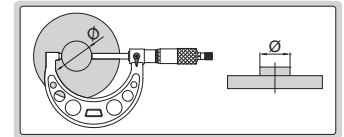
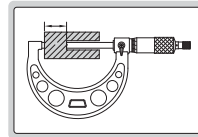


- Graduation 0.01mm
- Carbide measuring faces
- Meet DIN863-1
- Ratchet stop
- Supplied with setting standards (except 0-25mm)



3209-25

Code	Range	Accuracy	L	a	b
3209-25	0-25mm	4µm	57mm	14mm	38mm
3209-50	25-50mm	4µm	82mm	15mm	49mm
3209-75	50-75mm	5µm	107mm	15mm	60mm
3209-100	75-100mm	5µm	133mm	16.5mm	73mm



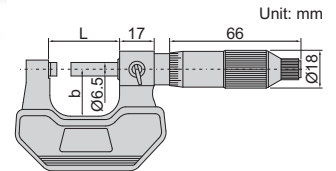
NON MAGNETIC MICROMETERS

- Suitable for magnetic materials
- Graduation: 0.01mm
- Non magnetic carbide measuring faces
- Ratchet stop



3231-25A

Code	Range	Accuracy	L	b
3231-25A	0-25mm	4µm	32mm	24mm
3231-50A	25-50mm	4µm	57mm	32mm
3231-75A	50-75mm	5µm	82mm	45mm
3231-100A	75-100mm	5µm	105mm	57mm



OUTSIDE MICROMETERS FOR LEFT OR RIGHT HANDERS

- Graduation 0.01mm
- Graduations on two sides
- Ratchet stop
- Carbide measuring faces
- Meet DIN863-1
- Supplied with setting standards (except 0-25mm)



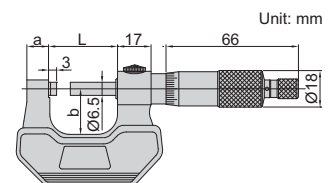
front



back

3236-25B

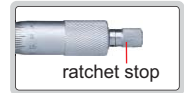
Code	Range	Accuracy	L	a	b
3236-25B	0-25mm	4µm	32	6	24
3236-50B	25-50mm	4µm	57	8	32
3236-75B	50-75mm	5µm	82	8	45
3236-100B	75-100mm	5µm	107	8	57
3236-125B	100-125mm	6µm	133	8	70
3236-150B	125-150mm	6µm	158	8	82
3236-175B	150-175mm	7µm	183	8	95
3236-200B	175-200mm	7µm	209	8	107



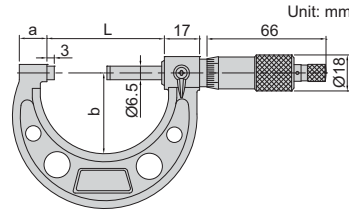


- Graduation 0.001mm
- Carbide measuring faces
- Meet DIN863-1
- Supplied with setting standards (except 0-25mm)

1µm GRADUATION OUTSIDE MICROMETERS



3210-25A



Ratchet stop type (mm)

Code	Range	Accuracy	L	a	b
3210-25A *	0-25mm	4µm	32	9	28
3210-50A *	25-50mm	4µm	57	14	38
3210-75A *	50-75mm	5µm	82	15	49
3210-100A *	75-100mm	5µm	107	15	60
3210-125A	100-125mm	6µm	133	16.5	73
3210-150A	125-150mm	6µm	158	16.5	85
3210-175A	150-175mm	7µm	183	19.4	104
3210-200A	175-200mm	7µm	209	19.4	117

Friction thimble type (mm)

Code	Range	Accuracy	L	a	b
3210-25FA *	0-25mm	4µm	32	9	28
3210-50FA *	25-50mm	4µm	57	14	38

Micrometer set (ratchet stop type)

Code	Range	Micrometers included
3210-753A *	0-75mm	3210-25A, 3210-50A, 3210-75A
3210-1004A *	0-100mm	3210-25A, 3210-50A, 3210-75A, 3210-100A
3210-1506A	0-150mm	3210-25A, 3210-50A, 3210-75A, 3210-100A, 3210-125A, 3210-150A

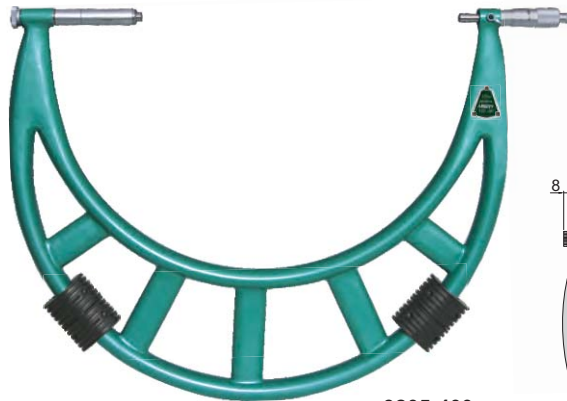
* Supplied with manufacturer inspection certificate traceable to DKD Germany

OUTSIDE MICROMETERS WITH EXTENSION ANVIL COLLAR

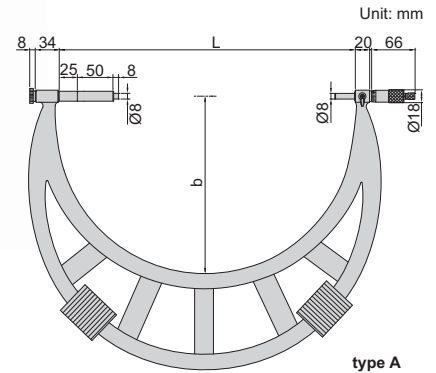
- Graduation 0.01mm
- Adjust collars for different measuring ranges
- Ratchet stop
- Carbide measuring faces
- Supplied with setting standards



adjust collars for different measuring ranges

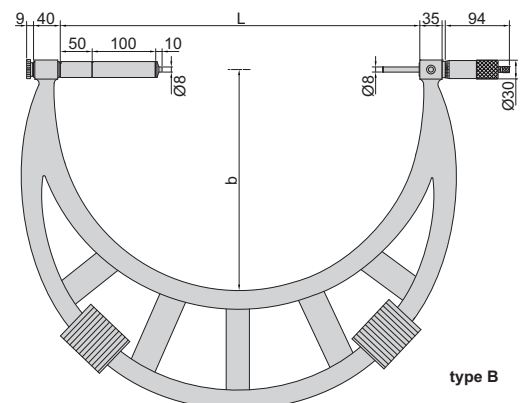


3205-400



Code	Range	Type	Accuracy	L	b	Setting standard (included)
3205-400	300-400mm	A	11µm	410	250	325, 375
3205-500	400-500mm	A	13µm	510	295	425, 475
3205-600	500-600mm	A	14µm	610	345	525, 575
3205-700	600-700mm	A	16µm	710	395	625, 675
3205-800	700-800mm	A	18µm	810	445	725, 775,
3205-900	800-900mm	A	20µm	910	495	825, 875
3205-1000	900-1000mm	A	22µm	1010	545	925, 975
3205-1200	1000-1200mm	B	22µm	1210	645	1050, 1150
3205-1400	1200-1400mm	B	24µm	1410	745	1250, 1350
3205-1600	1400-1600mm	B	28µm	1610	845	1450, 1550
3205-1800	1600-1800mm	B	31µm	1810	945	1650, 1750
3205-2000	1800-2000mm	B	34µm	2010	1045	1850, 1950

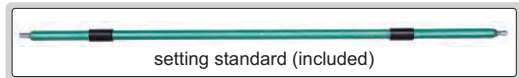
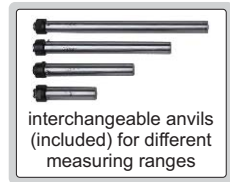
(mm)



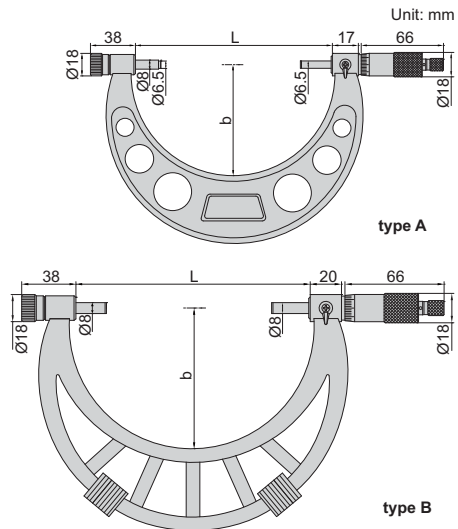
OUTSIDE MICROMETERS WITH INTERCHANGEABLE ANVILS



- Graduation 0.01mm
- Ratchet stop
- Meet DIN863-3
- Carbide measuring faces
- Supplied with setting standards



Code	Range	Type	Accuracy	L	b	Setting standard (included)
3206-50A	0-50mm	A	4µm	58	35	25
3206-100A	0-100mm	A	5µm	108	57	25, 50, 75
3206-150A	0-150mm	A	6µm	158	82	25, 50, 75, 100, 125
3206-151A	50-150mm	A	6µm	158	82	50, 75, 100, 125
3206-200A	100-200mm	A	7µm	208	114	100, 125, 150, 175
3206-300A	150-300mm	A	9µm	308	165	150, 175, 200, 225, 250, 275
3206-301A	200-300mm	A	9µm	308	165	200, 225, 250, 275
3206-400	300-400mm	B	11µm	409	224	325, 375
3206-500	400-500mm	B	13µm	509	275	425, 475
3206-600	500-600mm	B	14µm	609	321	525, 575
3206-700	600-700mm	B	16µm	709	371	625, 675
3206-800	700-800mm	B	18µm	809	426	725, 775
3206-900	800-900mm	B	20µm	909	476	825, 875
3206-1000	900-1000mm	B	22µm	1009	576	925, 975



DIGITAL OUTSIDE MICROMETERS WITH INTERCHANGEABLE ANVILS

IP65 WATERPROOF **DATA OUTPUT**

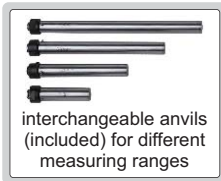
- Resolution 0.001mm/0.0001" (resolution of 3506-100A and 3506-150A is 0.001mm/0.00005")
- IP65 dust/waterproof
- Button function: on/off, set, mm/inch, ABS/INC
- Data output
- LR44 battery, automatic power off
- Ratchet stop
- Carbide measuring faces
- Supplied with setting standards
- Optional accessory: data output cable (code 7315-30, 7302-30)



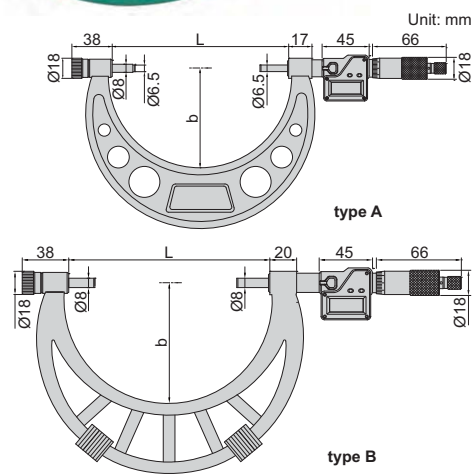
3506-100A



3506-400A

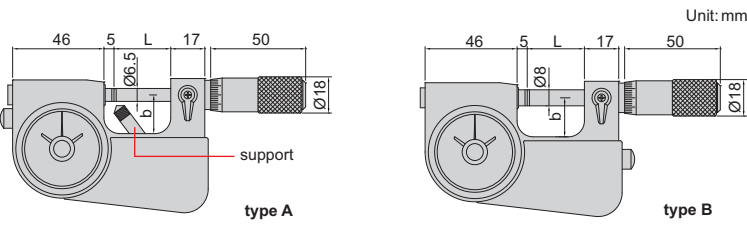


Code	Range	Type	Accuracy	L	b	Setting standard (included)
3506-100A	0-100mm/0-4"	A	±5µm	105	57	25, 50, 75
3506-150A	0-150mm/0-6"	A	±6µm	155	82	25, 50, 75, 100, 125
3506-300A	150-300mm/6-12"	A	±8µm	305	165	150, 175, 200, 225, 250, 275
3506-301A	200-300mm/8-12"	A	±8µm	305	165	200, 225, 250, 275
3506-400A	300-400mm/12-16"	B	±9µm	405	224	325, 375
3506-500A	400-500mm/16-20"	B	±11µm	505	275	425, 475
3506-600A	500-600mm/20-24"	B	±12µm	605	321	525, 575
3506-700A	600-700mm/24-28"	B	±13µm	705	371	625, 675
3506-800A	700-800mm/28-32"	B	±15µm	805	426	725, 775
3506-900A	800-900mm/32-36"	B	±16µm	905	476	825, 875
3506-1000A	900-1000mm/36-40"	B	±17µm	1005	576	925, 975



ATTENTION: SETTING STANDARDS ARE NOT INCLUDED

INDICATING MICROMETERS



- Meet DIN863-3
- Micrometer head graduation: 0.002mm
- Dial indicator: range ± 0.04 mm, graduation 0.001mm, accuracy 0.001mm
- Carbide measuring faces
- Optional accessory: gage blocks grade 0 (4101-A series), for zero setting



3332-25



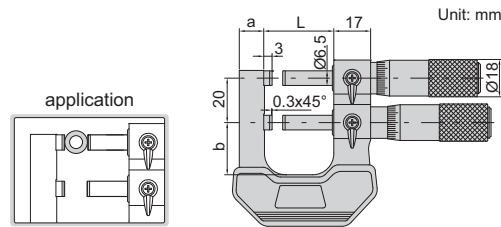
3332-25B

Code	Micrometer head range	Micrometer head accuracy	Type	L	b	Remark
3332-25	0-25mm	4 μ m	A	28.5	19	with support
3332-50	25-50mm	4 μ m	A	53.5	30	with support
3332-75	50-75mm	5 μ m	A	78.5	45	without support
3332-100	75-100mm	5 μ m	A	103.5	57	without support
3332-25B	0-25mm	4 μ m	B	28.5	19	without support

5

LIMIT MICROMETERS

- Used as Go/No-Go gage by setting upper and lower limits
- Graduation 0.002mm
- Carbide measuring faces
- Supplied with setting standard (except 0-25mm)



3235-25A

Code	Range	Accuracy	L	a	b
3235-25A	0-25mm	4 μ m	32mm	12mm	24mm
3235-50A	25-50mm	4 μ m	57mm	15mm	32mm

ATTENTION: NOT SUITABLE FOR 0.001MM DIAL INDICATORS

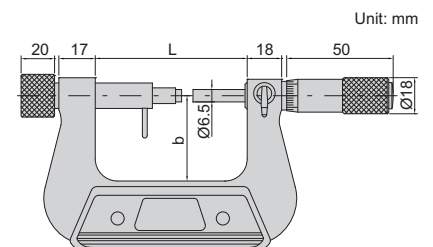
MICROMETERS WITH DIAL INDICATOR

- Meet DIN863-3
- Micrometer head graduation 0.01mm
- Anvil retracting range: 8mm
- Carbide measuring faces
- Supplied with setting standards (except 0-25mm)
- Optional accessory: dial indicators (graduation 0.01mm), digital indicators (resolution 0.01mm/0.0005")



3331-25A

Code	Micrometer head range	Micrometer head accuracy	L	b
3331-25A	0-25mm	4 μ m	67mm	38mm
3331-50A	25-50mm	4 μ m	92.4mm	50mm
3331-75A	50-75mm	5 μ m	117.6mm	62mm
3331-100A	75-100mm	5 μ m	143mm	70mm
3331-125A	100-125mm	6 μ m	168.2mm	82mm
3331-150A	125-150mm	6 μ m	192mm	94.5mm
3331-175A	150-175mm	7 μ m	217mm	107mm



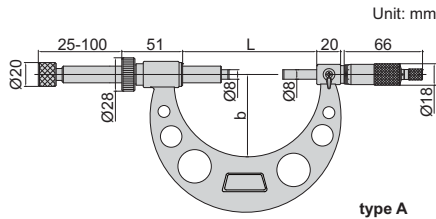
MICROMETERS WITH DIAL INDICATOR

ATTENTION: NOT SUITABLE FOR 0.001MM DIAL INDICATORS



dial indicator is optional

3296-100A

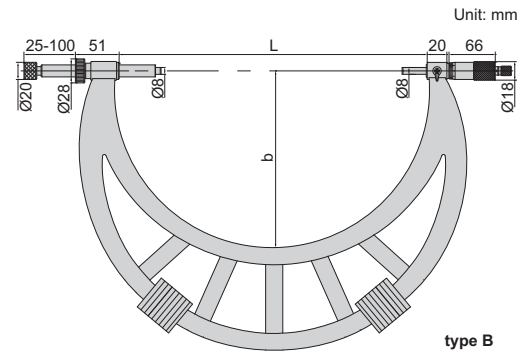


type A



dial indicator is optional

3296-400A



type B

Code	Range	Type	Accuracy	L	b
3296-100A	0-100mm	A	6µm	115	68
3296-200A	100-200mm	A	7µm	215	120
3296-300A	200-300mm	A	8µm	315	170
3296-400A	300-400mm	B	9µm	415	225
3296-500A	400-500mm	B	10µm	515	275
3296-600A	500-600mm	B	11µm	615	325
3296-700A	600-700mm	B	12µm	715	375
3296-800A	700-800mm	B	13µm	815	430
3296-900A	800-900mm	B	14µm	915	480
3296-1000A	900-1000mm	B	15µm	1015	530

- Meet DIN863-3
- Graduation 0.01mm
- Ratchet stop
- Carbide measuring faces
- Supplied with setting standards
- Optional accessory: dial indicators (graduation 0.01mm) digital indicators (resolution 0.01mm/0.0005")

GROOVE MICROMETERS

- Measure width of grooves inside bores
- Graduation 0.01mm
- Two graduations for inside and outside measurements
- Non-rotating spindle



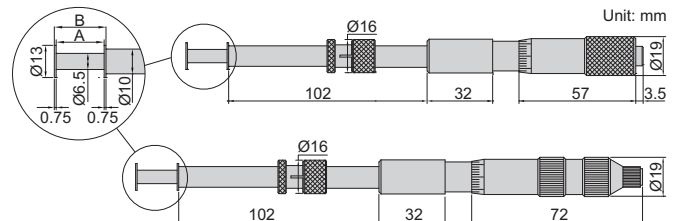
3287-25A



3287-50B

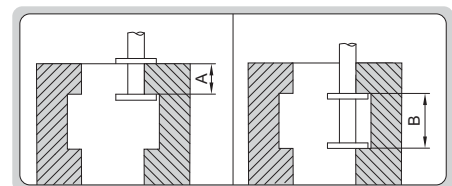
No ratchet stop

Code	Range (outside A)	Range (inside B)	Accuracy
3287-25A	0-25mm	1.6-26.5mm	10µm
3287-50A	25-50mm	26.5-51.5mm	10µm
3287-75A	50-75mm	51.5-76.5mm	10µm
3287-100A	75-100mm	76.5-101.5mm	10µm



Two-directional ratchet stop

Code	Range (outside A)	Range (inside B)	Accuracy
3287-25B	0-25mm	1.6-26.5mm	10µm
3287-50B	25-50mm	26.5-51.5mm	10µm
3287-75B	50-75mm	51.5-76.5mm	10µm
3287-100B	75-100mm	76.5-101.5mm	10µm





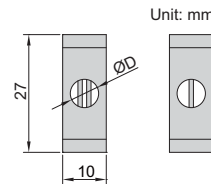
- Used with standard outside micrometers to measure pitch diameter of screw threads
- Diameter accuracy: $\pm 0.5\mu\text{m}$
- Cylindricity: $1\mu\text{m}$
- Hardness: HRC60
- Supplied with manufacturer inspection certificate



Formula of pitch diameter E
 $E = M - 3d + 0.866025P$
M=measured value of the micrometer
d=diameter of the pin gage (choose diameter of pin gage according to pitch: $d = 0.577P$)
P=screw thread pitch
The formula is suitable for 60° screw


7382-19

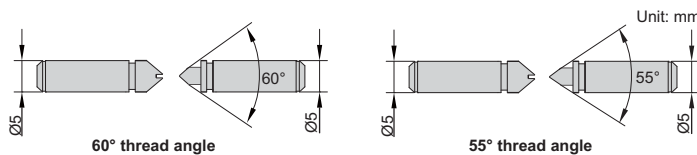
application


For outside micrometers with spindle Ø6.35mm (ØD)

Code	Pin gage diameter (Ød)	Applicable pitch
7382-11	0.170mm	0.2mm, 0.25mm, 0.3mm
7382-12	0.195mm	0.35mm
7382-13	0.220mm	0.4mm
7382-14	0.250mm	0.45mm
7382-15	0.290mm	0.5mm
7382-16	0.335mm	0.6mm
7382-17	0.390mm	0.7mm
7382-18	0.455mm	0.75mm, 0.8mm
7382-19	0.530mm	0.9mm
7382-110	0.620mm	1.0mm
7382-111	0.725mm	1.25mm
7382-112	0.895mm	1.5mm
7382-113	1.100mm	1.75mm, 2.0mm
7382-114	1.350mm	2.5mm
7382-115	1.650mm	3.0mm
7382-116	2.050mm	3.5mm
7382-117	2.550mm	4mm, 4.5mm
7382-118	3.200mm	5mm, 5.5mm, 6mm
7382-1S	18 pairs/set, including all above 3-wires	

For outside micrometers with spindle Ø6.50mm (ØD)

Code	Pin gage diameter (Ød)	Applicable pitch
7382-21	0.170mm	0.2mm, 0.25mm, 0.3mm
7382-22	0.195mm	0.35mm
7382-23	0.220mm	0.4mm
7382-24	0.250mm	0.45mm
7382-25	0.290mm	0.5mm
7382-26	0.335mm	0.6mm
7382-27	0.390mm	0.7mm
7382-28	0.455mm	0.75mm, 0.8mm
7382-29	0.530mm	0.9mm
7382-210	0.620mm	1.0mm
7382-211	0.725mm	1.25mm
7382-212	0.895mm	1.5mm
7382-213	1.100mm	1.75mm, 2.0mm
7382-214	1.350mm	2.5mm
7382-215	1.650mm	3.0mm
7382-216	2.050mm	3.5mm
7382-217	2.550mm	4mm, 4.5mm
7382-218	3.200mm	5mm, 5.5mm, 6mm
7382-2S	18 pairs/set, including all above 3-wires	

MEASURING TIPS FOR SCREW THREAD MICROMETERS

7381-T13
Whitworth thread (55° thread angle)
Metric and unified thread (60° thread angle)

Code	Pitch
7381-T11	0.4-0.5mm/ 64-48TPI
7381-T12	0.6-0.9mm/ 44-28TPI
7381-T13	1-1.75mm/ 24-14TPI
7381-T14	2-3mm/ 13-9TPI
7381-T15	3.5-5mm/ 8-5TPI
7381-T16	5.5-7mm/ 4.5-3.5TPI
7381-TS	6 pairs/set, including all above tips

- Supplied in pair
- Suitable for 3281, 3581 series micrometers

Code	Pitch
7381-T21	60-48TPI
7381-T22	48-40TPI
7381-T23	40-32TPI
7381-T24	32-24TPI
7381-T25	24-18TPI
7381-T26	18-14TPI
7381-T27	14-10TPI
7381-T28	10-7TPI
7381-T29	7-4.5TPI
7381-T210	4.5-3.5TPI
7381-T2S	10 pairs/set, including all above tips

SCREW THREAD MICROMETERS

NON-ROTATING SPINDLE

5

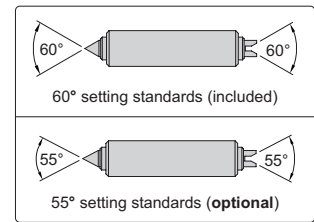
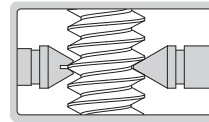


3281-25A
(measuring tips are optional)



3281-S25
(measuring tips are included)

- Measure pitch diameter of screw threads
- Graduation 0.01mm
- Non-rotating spindle
- Ratchet stop
- Supplied with 60° setting standards (except 0-25mm)
- Optional accessory: 55° setting standards



Measuring tips are optional (mm)

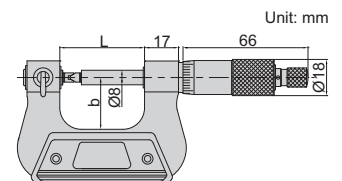
Code	Range	L	b	55° setting standard (optional)
3281-25A	0-25mm	42	26	—
3281-50A	25-50mm	67	38	3281-SP1
3281-75A	50-75mm	92	50	3281-SP2
3281-100A	75-100mm	117.6	62	3281-SP3
3281-125A	100-125mm	143	70	3281-SP4
3281-150A	125-150mm	168.2	82	3281-SP5
3281-175A	150-175mm	192	94.5	3281-SP6
3281-200A	175-200mm	217	107	3281-SP7

Measuring tips are included (mm)

Code	Range	L	b	Measuring tips (included)	55° setting standard (optional)
3281-S25	0-25mm	42	26	6 pairs of measuring tips: metric and unified thread (60° thread angle) 0.4-0.5mm/64-48TPI, 0.6-0.9mm/44-28TPI, 1-1.75mm/24-14TPI, 2-3mm/13-9TPI, 3.5-5mm/8-5TPI, 5.5-7mm/4.5-3.5TPI	—
3281-S50	25-50mm	67	38		3281-SP1
3281-S75	50-75mm	92	50		3281-SP2
3281-S100	75-100mm	117.6	62		3281-SP3
3281-S125	100-125mm	143	70		3281-SP4
3281-S150	125-150mm	168.2	82		3281-SP5
3281-S175	150-175mm	192	94.5		3281-SP6
3281-S200	175-200mm	217	107		3281-SP7

accuracy of micrometers with tips (mm)

Pitch	Range					
	0-25	25-50	50-75	75-100	100-125	125-200
0.4~0.5	±0.01	-	-	-	-	-
0.6~0.8	±0.01	±0.013	-	-	-	-
1~1.25	±0.012	±0.015	±0.017	±0.017	-	-
1.5~2.0	±0.014	±0.017	±0.019	±0.019	±0.020	±0.023
2.5~3.5	±0.016	±0.019	±0.021	±0.021	±0.023	±0.025
4.0~7.0	-	±0.021	±0.023	±0.023	±0.025	±0.028



DATA
OUTPUT

NON-ROTATING
SPINDLE

DIGITAL SCREW THREAD MICROMETERS

5

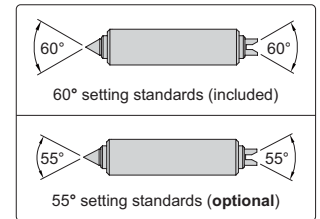
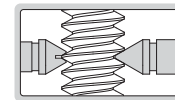


3581-25A
(measuring tips are optional)



3581-S50
(measuring tips are included)

- Measure pitch diameter of screw threads
- Resolution 0.001mm/0.00005"
- Button function: on/off, set, mm/inch, ABS/INC
- Data output
- LR44 battery, automatic power off
- Non-rotating spindle
- Ratchet stop
- Supplied with 60° setting standards (except 0-25mm/0-1")
- Optional accessory: 55° setting standards, data output cable (code **7315-30**, **7302-30**)



Measuring tips are optional (mm)

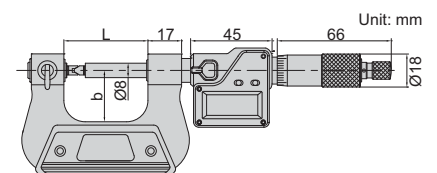
Code	Range	L	b	55° setting standard (optional)
3581-25A	0-25mm/0-1"	42	26	—
3581-50A	25-50mm/1-2"	67	38	3281-SP1
3581-75A	50-75mm/2-3"	92	50	3281-SP2
3581-100A	75-100mm/3-4"	117.6	62	3281-SP3
3581-125A	100-125mm/4-5"	143	70	3281-SP4
3581-150A	125-150mm/5-6"	168.2	82	3281-SP5
3581-175A	150-175mm/6-7"	192	94.5	3281-SP6
3581-200A	175-200mm/7-8"	217	107	3281-SP7

Measuring tips are included (mm)

Code	Range	L	b	Measuring tips (included)	55° setting standard (optional)
3581-S25	0-25mm/0-1"	42	26	6 pairs of measuring tips: metric and unified thread (60° thread angle) 0.4-0.5mm/64-48TPI, 0.6-0.9mm/44-28TPI, 1-1.75mm/24-14TPI, 2-3mm/13-9TPI, 3.5-5mm/8-5TPI, 5.5-7mm/4.5-3.5TPI	—
3581-S50	25-50mm/1-2"	67	38		3281-SP1
3581-S75	50-75mm/2-3"	92	50		3281-SP2
3581-S100	75-100mm/3-4"	117.6	62		3281-SP3
3581-S125	100-125mm/4-5"	143	70		3281-SP4
3581-S150	125-150mm/5-6"	168.2	82		3281-SP5
3581-S175	150-175mm/6-7"	192	94.5		3281-SP6
3581-S200	175-200mm/7-8"	217	107		3281-SP7

accuracy of micrometers with tips (mm)

Pitch	Range					
	0-25	25-50	50-75	75-100	100-125	125-200
0.4~0.5	±0.01	-	-	-	-	-
0.6~0.8	±0.01	±0.013	-	-	-	-
1~1.25	±0.012	±0.015	±0.017	±0.017	-	-
1.5~2.0	±0.014	±0.017	±0.019	±0.019	±0.020	±0.023
2.5~3.5	±0.016	±0.019	±0.021	±0.021	±0.023	±0.025
4.0~7.0	-	±0.021	±0.023	±0.023	±0.025	±0.028



GEAR TOOTH MICROMETERS

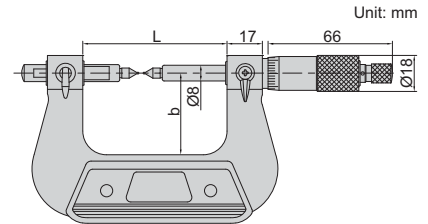
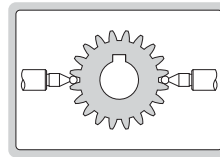
- Meet DIN863-3
- Measure over-pin diameter of gears
- Graduation 0.01mm
- Ratchet stop
- Supplied with setting standards (except 0-25mm)
- Optional accessory: ball tips (code 7391)

5

Code	Range	Accuracy	L	b
3291-25	0-25mm	4 μ m	67	38
3291-50	25-50mm	4 μ m	92.4	50
3291-75	50-75mm	5 μ m	117.6	62
3291-100	75-100mm	5 μ m	143	70
3291-125	100-125mm	6 μ m	168.2	82
3291-150	125-150mm	6 μ m	192	94.5
3291-175	150-175mm	7 μ m	217	107



3291-25

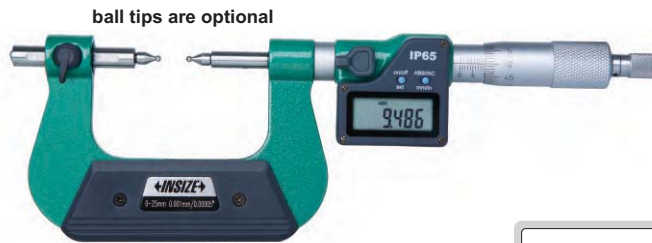


DIGITAL GEAR TOOTH MICROMETERS

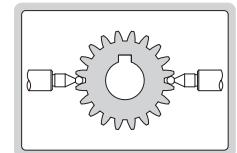
IP65
WATERPROOF

DATA
OUTPUT

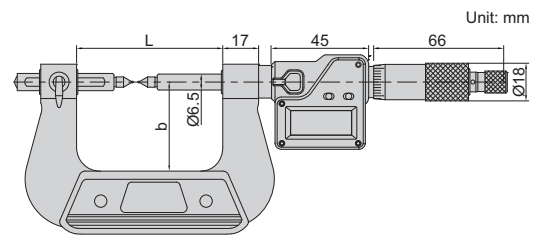
- Measure over-pin diameter of gears
- Resolution 0.001mm/0.00005"
- IP65 dust/waterproof
- Button function: on/off, set, mm/inch, ABS/INC
- Data output
- LR44 battery, automatic power off
- Ratchet stop
- Supplied with setting standards (except 0-25mm/0-1")
- Optional accessory: ball tips (code 7391), data output cable (code 7315-30, 7302-30)



3591-25A



Code	Range	Accuracy	L	b
3591-25A	0-25mm/0-1"	\pm 4 μ m	67	38
3591-50A	25-50mm/1-2"	\pm 4 μ m	92.4	50
3591-75A	50-75mm/2-3"	\pm 5 μ m	117.6	62
3591-100A	75-100mm/3-4"	\pm 5 μ m	143	70
3591-125A	100-125mm/4-5"	\pm 6 μ m	168.2	82
3591-150A	125-150mm/5-6"	\pm 6 μ m	192	94.5
3591-175A	150-175mm/6-7"	\pm 7 μ m	217	107



BALL TIPS FOR GEAR TOOTH MICROMETERS

- Supplied in pair
- Suitable for 3291, 3591 series micrometers

Code	Ball dia. (D)	Code	Ball dia. (D)
7391-T2	SØ1.5mm	7391-T7	SØ4.0mm
7391-T3	SØ2.0mm	7391-T8	SØ4.5mm
7391-T4	SØ2.5mm	7391-T9	SØ5.0mm
7391-T5	SØ3.0mm	7391-T10	SØ6.0mm
7391-T6	SØ3.5mm		



7391-T5



POINT MICROMETERS

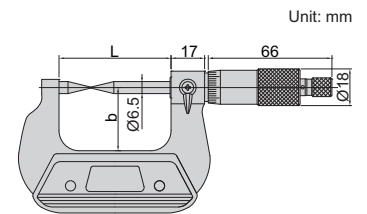
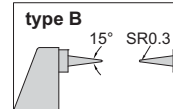
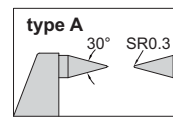
- Measure the web thickness of drills, small grooves and keyways
- Graduation 0.01mm
- Ratchet stop
- Carbide tips
- Supplied with setting standards (except 0-25mm)



3230-25A

(mm)

Code	Range	Type	Accuracy	L	b
3230-25A	0-25mm	A	4μm	57	32
3230-50A	25-50mm	A	4μm	82	44.5
3230-75A	50-75mm	A	5μm	107	57
3230-100A	75-100mm	A	5μm	132.6	69.5
3230-25BA	0-25mm	B	4μm	57	32
3230-50BA	25-50mm	B	4μm	82	44.5
3230-75BA	50-75mm	B	5μm	107	57
3230-100BA	75-100mm	B	5μm	132.6	69.5



DATA
OUTPUT

IP65
WATERPROOF

DIGITAL POINT MICROMETERS

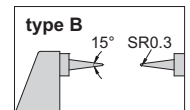
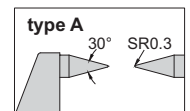
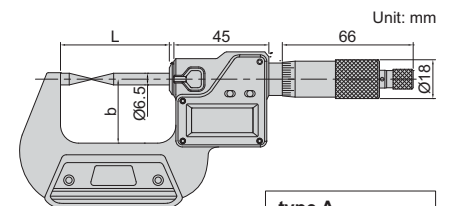
- Measure the web thickness of drills, small grooves and keyways
- Resolution 0.001mm/0.00005"
- IP65 dust/waterproof
- Button function: on/off, set, mm/inch, ABS/INC
- Data output
- LR44 battery, automatic power off
- Ratchet stop
- Carbide tips
- Supplied with setting standards (except 0-25mm/0-1")
- Optional accessory: data output cable (code 7315-30, 7302-30)



3530-25A

(mm)

Code	Range	Type	Accuracy	L	b
3530-25A	0-25mm/0-1"	A	±4μm	57	32
3530-50A	25-50mm/1-2"	A	±4μm	82	44.5
3530-75A	50-75mm/2-3"	A	±5μm	107	57
3530-100A	75-100mm/3-4"	A	±5μm	132.6	69.5
3530-25BA	0-25mm/0-1"	B	±4μm	57	32
3530-50BA	25-50mm/1-2"	B	±4μm	82	44.5
3530-75BA	50-75mm/2-3"	B	±5μm	107	57
3530-100BA	75-100mm/3-4"	B	±5μm	132.6	69.5



BLADE MICROMETERS

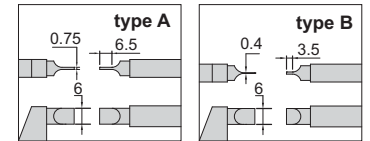
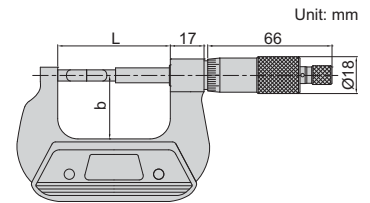
NON-ROTATING SPINDLE

- Meet DIN863-3
- Measure the groove diameter of shafts and keyways
- Graduation 0.01mm
- Non-rotating spindle
- Ratchet stop
- Supplied with setting standards (except 0-25mm)

5



3232-25A



Code	Range	Type	Accuracy	L	b
3232-25A	0-25mm	A	4μm	57	32
3232-50A	25-50mm	A	4μm	82	44.5
3232-75A	50-75mm	A	5μm	107	57
3232-100A	75-100mm	A	5μm	132.6	69.5
3232-125A	100-125mm	A	6μm	158	82
3232-150A	125-150mm	A	6μm	183.4	94.5
3232-175A	150-175mm	A	7μm	208.8	107
3232-25BA	0-25mm	B	4μm	57	32
3232-50BA	25-50mm	B	4μm	82	44.5
3232-75BA	50-75mm	B	5μm	107	57
3232-100BA	75-100mm	B	5μm	132.6	69.5
3232-125BA	100-125mm	B	6μm	158	82
3232-150BA	125-150mm	B	6μm	183.4	94.5
3232-175BA	150-175mm	B	7μm	208.8	107

DIGITAL BLADE MICROMETERS

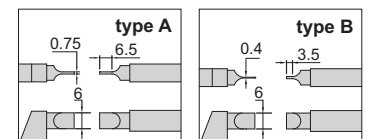
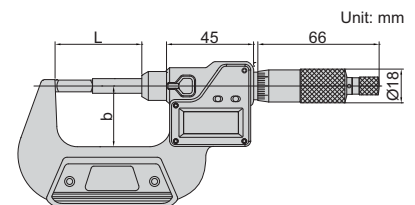
DATA OUTPUT

NON-ROTATING SPINDLE

- Measure the groove diameter of shafts and keyways
- Resolution 0.001mm/0.00005"
- Non-rotating spindle
- Button function: on/off, set, mm/inch, ABS/INC
- Data output
- LR44 battery, automatic power off
- Ratchet stop
- Supplied with setting standards (except 0-25mm/0-1")
- Optional accessory: data output cable (code 7315-30, 7302-30)



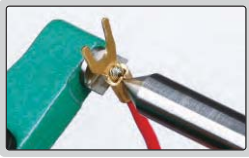
3532-25A



Code	Range	Type	Accuracy	L	b
3532-25A	0-25mm/0-1"	A	±4μm	57	32
3532-50A	25-50mm/1-2"	A	±4μm	82	44.5
3532-75A	50-75mm/2-3"	A	±5μm	107	57
3532-100A	75-100mm/3-4"	A	±5μm	132.6	69.5
3532-125A	100-125mm/4-5"	A	±6μm	158	82
3532-150A	125-150mm/5-6"	A	±6μm	183.4	94.5
3532-175A	150-175mm/6-7"	A	±7μm	208.8	107
3532-25BA	0-25mm/0-1"	B	±4μm	57	32
3532-50BA	25-50mm/1-2"	B	±4μm	82	44.5
3532-75BA	50-75mm/2-3"	B	±5μm	107	57
3532-100BA	75-100mm/3-4"	B	±5μm	132.6	69.5
3532-125BA	100-125mm/4-5"	B	±6μm	158	82
3532-150BA	125-150mm/5-6"	B	±6μm	183.4	94.5
3532-175BA	150-175mm/6-7"	B	±7μm	208.8	107

RELATIVE PRODUCT: DIGITAL CRIMP HEIGHT CALIPER (CODE 1165-150A)

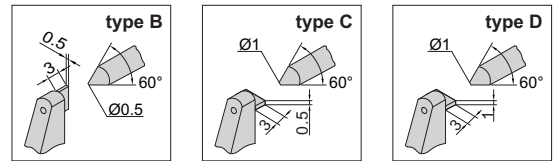
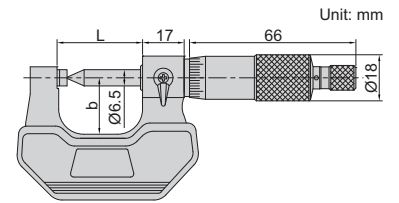
CRIMP HEIGHT MICROMETERS



3266-25BA

- Measure the height of crimp contact
- Graduation 0.01mm
- Ratchet stop
- Supplied with setting standards (except 0-25mm)

Code	Range	Type	Accuracy	L	b
3266-25BA	0-25mm	B	4μm	34	24
3266-50BA	25-50mm	B	4μm	59	32
3266-75BA	50-75mm	B	5μm	85	45
3266-100BA	75-100mm	B	5μm	110	57
3266-25CA	0-25mm	C	4μm	34	24
3266-25DA	0-25mm	D	4μm	34	24



IP65
WATERPROOF

DATA
OUTPUT

RELATIVE PRODUCT: DIGITAL CRIMP HEIGHT CALIPER (CODE 1165-150A)

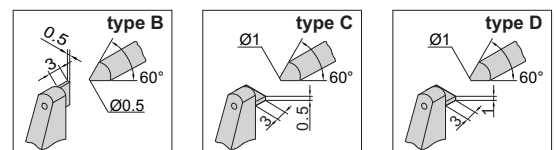
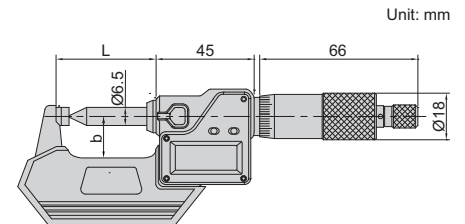
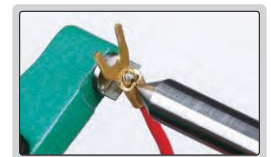
DIGITAL CRIMP HEIGHT MICROMETERS



3566-25BA

- Measure the height of crimp contact
- Resolution 0.001mm/0.00005"
- IP65 dust/waterproof
- Button function: on/off, set, mm/inch, ABS/INC
- Data output
- LR44 battery, automatic power off
- Ratchet stop
- Supplied with setting standards (except 0-25mm/0-1")
- Optional accessory: data output cable (code 7315-30, 7302-30)

Code	Range	Type	Accuracy	L	b
3566-25BA	0-25mm/0-1"	B	±4μm	34.5	25
3566-50BA	25-50mm/0-1"	B	±4μm	59.5	32
3566-75BA	50-75mm/0-1"	B	±5μm	84.5	44.5
3566-100BA	75-100mm/0-1"	B	±5μm	109.5	57
3566-25CA	0-25mm/0-1"	C	±4μm	34.5	25
3566-25DA	0-25mm/0-1"	D	±4μm	34.5	25



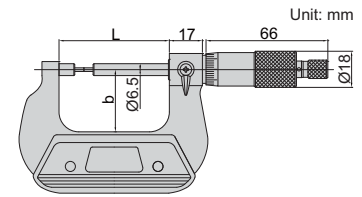
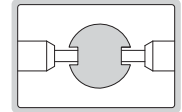
SPLINE MICROMETERS

- Meet DIN863-3
- Measure splined shafts, slots and keyways
- Graduation 0.01mm
- Ratchet stop
- Carbide measuring faces
- Supplied with setting standards (except 0-25mm)

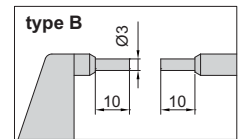
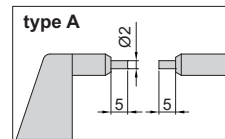
5



3233-25BA



Code	Range	Type	Accuracy	L	b
3233-25A	0-25mm	A	4μm	57	32
3233-50A	25-50mm	A	4μm	82	44.5
3233-75A	50-75mm	A	5μm	107	57
3233-100A	75-100mm	A	5μm	132.6	69.5
3233-125A	100-125mm	A	6μm	158	82
3233-150A	125-150mm	A	6μm	183.4	94.5
3233-175A	150-175mm	A	7μm	208.8	107
3233-25BA	0-25mm	B	4μm	57	32
3233-50BA	25-50mm	B	4μm	82	44.5
3233-75BA	50-75mm	B	5μm	107	57
3233-100BA	75-100mm	B	5μm	132.6	69.5
3233-125BA	100-125mm	B	6μm	158	82
3233-150BA	125-150mm	B	6μm	183.4	94.5
3233-175BA	150-175mm	B	7μm	208.8	107



DIGITAL SPLINE MICROMETERS

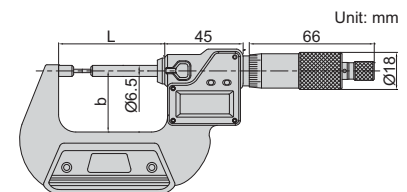
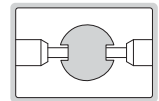
IP65
WATERPROOF

DATA
OUTPUT

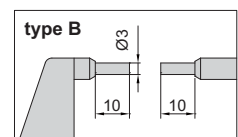
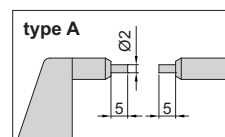
- Measure splined shafts, slots and keyways
- Resolution 0.001mm/0.00005"
- IP65 dust/waterproof
- Button function: on/off, set, mm/inch, ABS/INC
- Data output
- LR44 battery, automatic power off
- Ratchet stop
- Carbide measuring faces
- Supplied with setting standards (except 0-25mm/0-1")
- Optional accessory: data output cable (code 7315-30, 7302-30)



3533-25BA



Code	Range	Type	Accuracy	L	b
3533-25A	0-25mm/0-1"	A	±4μm	57	32
3533-50A	25-50mm/1-2"	A	±4μm	82	44.5
3533-75A	50-75mm/2-3"	A	±5μm	107	57
3533-100A	75-100mm/3-4"	A	±5μm	132.6	69.5
3533-125A	100-125mm/4-5"	A	±6μm	158	82
3533-150A	125-150mm/5-6"	A	±6μm	183.4	94.5
3533-175A	150-175mm/6-7"	A	±7μm	208.8	107
3533-25BA	0-25mm/0-1"	B	±4μm	57	32
3533-50BA	25-50mm/1-2"	B	±4μm	82	44.5
3533-75BA	50-75mm/2-3"	B	±5μm	107	57
3533-100BA	75-100mm/3-4"	B	±5μm	132.6	69.5
3533-125BA	100-125mm/4-5"	B	±6μm	158	82
3533-150BA	125-150mm/5-6"	B	±6μm	183.4	94.5
3533-175BA	150-175mm/6-7"	B	±7μm	208.8	107

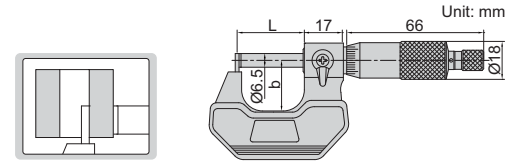


CYLINDRICAL ANVIL TUBE MICROMETERS

- Measure wall thickness of tubes
- Graduation 0.01mm
- Ratchet stop
- Carbide spindle tip
- Supplied with setting standards (except 0-25mm)

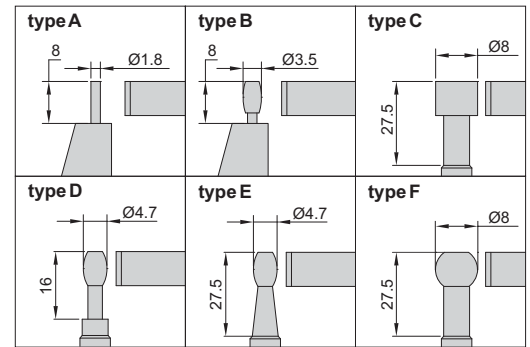


3261-25A



(mm)

Code	Range	Type	Accuracy	L	b
3261-25A	0-25mm	A	6µm	36	25
3261-50A	25-50mm	A	6µm	61	32
3261-25BA	0-25mm	B	6µm	36	25
3261-50BA	25-50mm	B	6µm	61	32
3261-25CA	0-25mm	C	6µm	36	25
3261-50CA	25-50mm	C	6µm	61	32
3261-25DA	0-25mm	D	6µm	36	25
3261-50DA	25-50mm	D	6µm	61	32
3261-25EA	0-25mm	E	6µm	36	25
3261-50EA	25-50mm	E	6µm	61	32
3261-25FA	0-25mm	F	6µm	36	25
3261-50FA	25-50mm	F	6µm	61	32



IP65
WATERPROOF

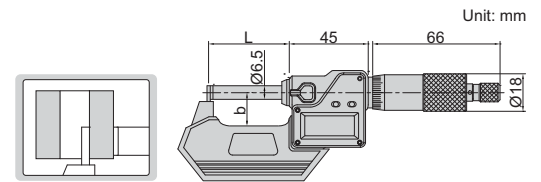
DATA
OUTPUT

DIGITAL CYLINDRICAL ANVIL TUBE MICROMETERS

- Measure wall thickness of tubes
- Resolution 0.001mm/0.00005"
- IP65 dust/waterproof
- Button function: on/off, set, mm/inch, ABS/INC
- Data output
- LR44 battery, automatic power off
- Ratchet stop
- Carbide spindle tip
- Supplied with setting standards (except 0-25mm/0-1")
- Optional accessory: data output cable (code 7315-30, 7302-30)

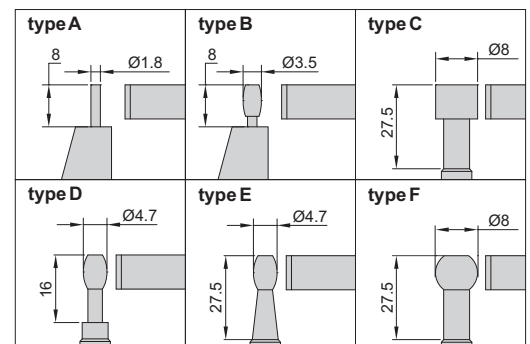


3561-25A



(mm)

Code	Range	Type	Accuracy	L	b
3561-25A	0-25mm/0-1"	A	±6µm	36	25
3561-50A	25-50mm/1-2"	A	±6µm	61	32
3561-25BA	0-25mm/0-1"	B	±6µm	36	25
3561-50BA	25-50mm/1-2"	B	±6µm	61	32
3561-25CA	0-25mm/0-1"	C	±6µm	36	25
3561-50CA	25-50mm/1-2"	C	±6µm	61	32
3561-25DA	0-25mm/0-1"	D	±6µm	36	25
3561-50DA	25-50mm/1-2"	D	±6µm	61	32
3561-25EA	0-25mm/0-1"	E	±6µm	36	25
3561-50EA	25-50mm/1-2"	E	±6µm	61	32
3561-25FA	0-25mm/0-1"	F	±6µm	36	25
3561-50FA	25-50mm/1-2"	F	±6µm	61	32

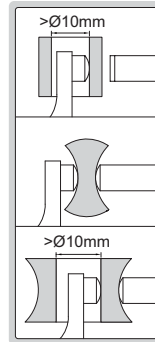


SPHERICAL ANVIL TUBE MICROMETERS

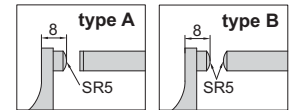
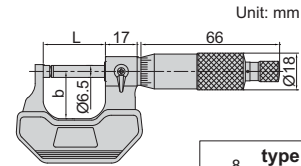
- Meet DIN863-3
- Measure wall thickness of tubes
- Graduation 0.01mm
- Ratchet stop
- Carbide measuring faces
- Supplied with setting standards (except 0-25mm)

Code	Range	Type	Accuracy	L	b
3260-25A	0-25mm	A	4µm	32	24
3260-50A	25-50mm	A	4µm	57	32
3260-75A	50-75mm	A	5µm	82	44.5
3260-100A	75-100mm	A	5µm	107	57
3260-25SA	0-25mm	B	4µm	32	24
3260-50SA	25-50mm	B	4µm	57	32
3260-75SA	50-75mm	B	5µm	82	44.5
3260-100SA	75-100mm	B	5µm	107	57

(mm)



3260-25A

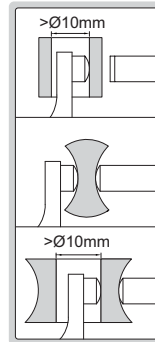


DIGITAL SPHERICAL ANVIL TUBE MICROMETERS

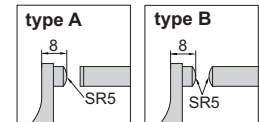
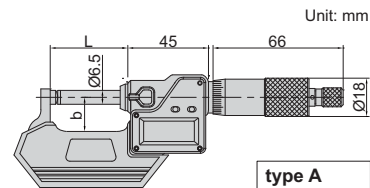
- Measure wall thickness of tubes
- Resolution 0.001mm/0.00005"
- IP65 dust/waterproof
- Button function: on/off, set, mm/inch, ABS/INC, data output
- Data output
- LR44 battery, automatic power off
- Ratchet stop
- Carbide measuring faces
- Supplied with setting standards (except 0-25mm/0-1")
- Optional accessory: data output cable (code 7315-30, 7302-30)

Code	Range	Type	Accuracy	L	b
3560-25A	0-25mm/0-1"	A	±4µm	32	24
3560-50A	25-50mm/1-2"	A	±4µm	57	32
3560-75A	50-75mm/2-3"	A	±5µm	82	44.5
3560-100A	75-100mm/3-4"	A	±5µm	107	57
3560-25SA	0-25mm/0-1"	B	±4µm	32	24
3560-50SA	25-50mm/1-2"	B	±4µm	57	32
3560-75SA	50-75mm/2-3"	B	±5µm	82	44.5
3560-100SA	75-100mm/3-4"	B	±5µm	107	57

(mm)



3560-25A



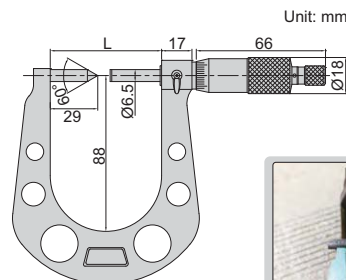
IP65
WATERPROOF

DATA
OUTPUT

DISK BRAKE MICROMETERS

- Measure thickness of disk brakes
- Graduation 0.01mm
- Ratchet stop
- Carbide measuring faces
- Supplied with setting standards

Code	Range	Accuracy	L
3288-33A	7.6-33mm	5µm	64.5mm
3288-50A	25-50mm	5µm	82mm



3288-33A

RELATIVE PRODUCT: DIGITAL DISK BRAKE AND PAD CALIPER
DIGITAL DRUM BRAKE CALIPER (CODE 1162-125A, 1167-150A, 1168-300A)

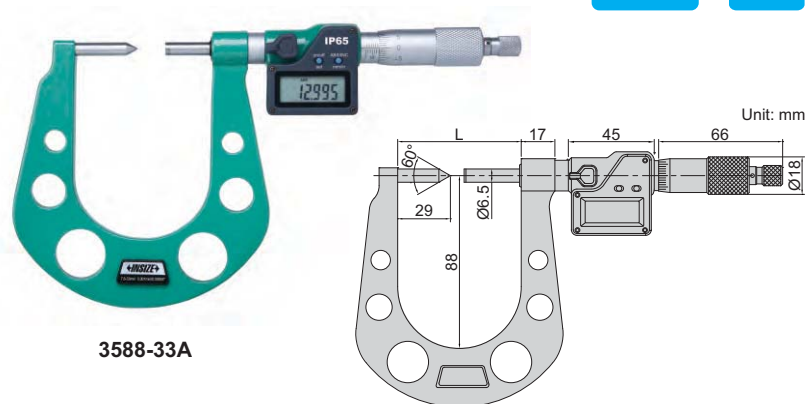
RELATIVE PRODUCT: DIGITAL DISK BRAKE AND PAD CALIPER
DIGITAL DRUM BRAKE CALIPER (CODE 1162-125A, 1167-150A, 1168-300A)

DIGITAL DISK BRAKE MICROMETERS

IP65
WATERPROOF

DATA
OUTPUT

- Measure thickness of disk brakes
- Resolution 0.001mm/0.00005"
- IP65 dust/waterproof
- Button function: on/off, set, mm/inch, ABS/INC
- Data output
- LR44 battery, automatic power off
- Ratchet stop
- Carbide measuring faces
- Supplied with setting standards
- Optional accessory: data output cable (code 7315-30, 7302-30)

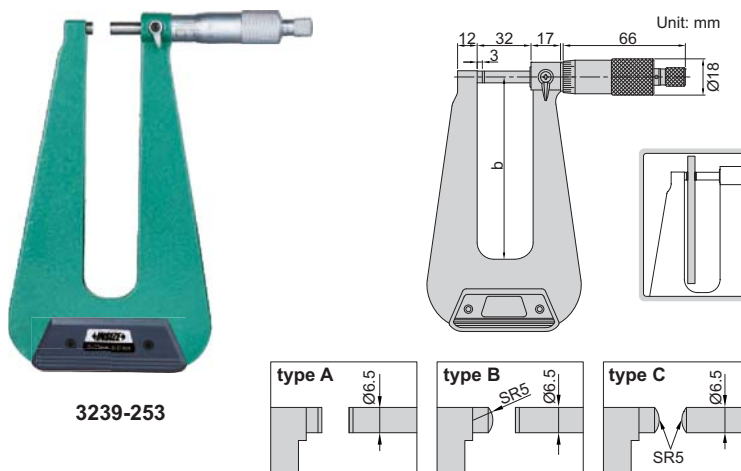


3588-33A

(mm)			
Code	Range	Accuracy	L
3588-33A	7.6-33mm/0.3-1.3"	±5µm	64.5
3588-50A	25-50mm/1-2"	±5µm	82

SHEET METAL MICROMETERS

- Deep frame suitable for sheet metal, paper and plastic
- Graduation 0.01mm
- Ratchet stop
- Carbide measuring faces



3239-253

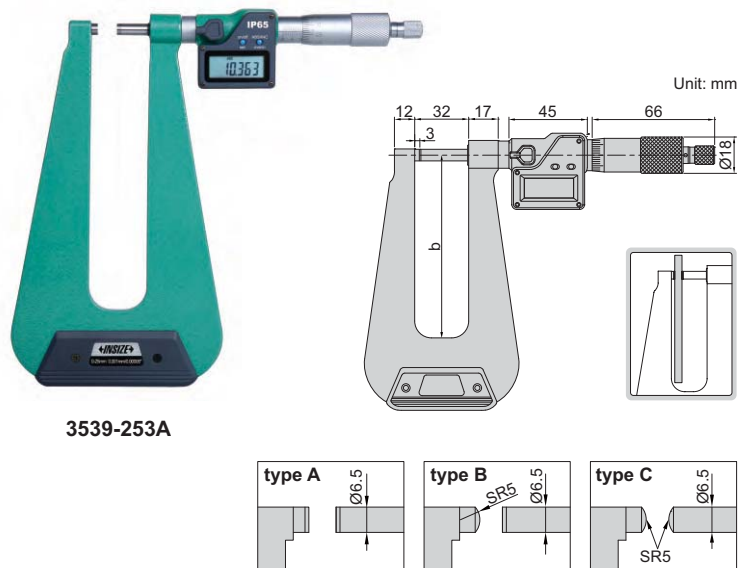
(mm)				
Code	Range	Type	Accuracy	b
3239-253	0-25mm	A	7µm	155
3239-253F	0-25mm	B	7µm	155
3239-254F	0-25mm	B	10µm	310
3239-253S	0-25mm	C	7µm	155

DIGITAL SHEET METAL MICROMETERS

DATA
OUTPUT

IP65
WATERPROOF

- Deep frame suitable for sheet metal, paper and plastic
- Resolution 0.001mm/0.00005"
- IP65 dust/waterproof
- Button function: on/off, set, mm/inch, ABS/INC
- Data output
- LR44 battery, automatic power off
- Ratchet stop
- Carbide measuring faces
- Optional accessory: data output cable (code 7315-30, 7302-30)



3539-253A

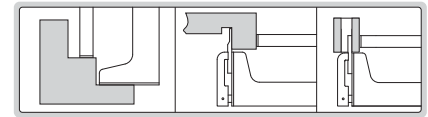
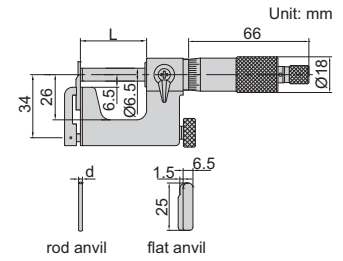
(mm)				
Code	Range	Type	Accuracy	b
3539-253A	0-25mm/0-1"	A	±7µm	155
3539-253FA	0-25mm/0-1"	B	±7µm	155
3539-254FA	0-25mm/0-1"	B	±10µm	310
3539-253SA	0-25mm/0-1"	C	±7µm	155

INTERCHANGEABLE ANVIL MICROMETERS

- Measure tube thickness, shoulder edge distance, rivet head height, etc.
- Supplied with flat anvil and rod anvil
- Graduation 0.01mm
- Ratchet stop
- Carbide spindle tip
- Setting standards are included (except 0-25mm)



3262-25A



5

Code	Range	Accuracy	L	(mm)	
				d	
3262-25A	0-25mm	4µm	28.5	Ø3	
3262-50A	25-50mm	4µm	53.5	Ø5	

DIGITAL INTERCHANGEABLE ANVIL MICROMETERS

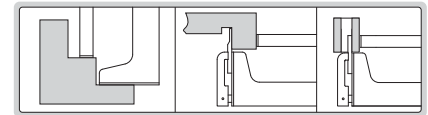
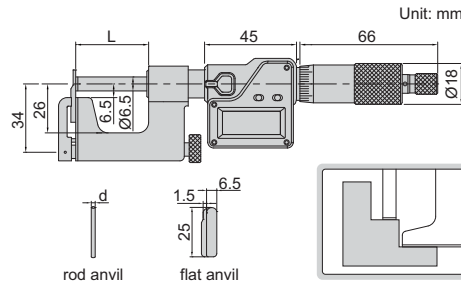
IP65
WATERPROOF

DATA
OUTPUT

- Measure tube thickness, shoulder edge distance, rivet head height, etc.
- Supplied with flat anvil and rod anvil
- Resolution 0.001mm/0.00005"
- IP65 dust/waterproof
- Button function: on/off, set, mm/inch, ABS/INC
- Data output
- LR44 battery, automatic power off
- Ratchet stop
- Carbide spindle tip
- Setting standards are included (except 0-25mm/0-1")
- Optional accessory: data output cable (code 7315-30, 7302-30)



3562-25A



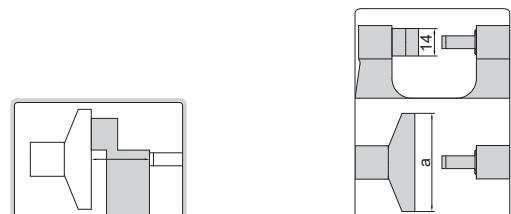
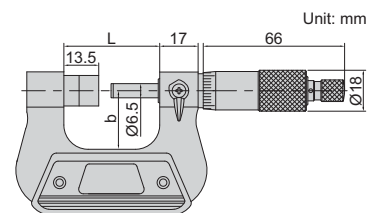
Code	Range	Accuracy	L	(mm)	
				d	
3562-25A	0-25mm/0-1"	±4µm	28.5	Ø3	
3562-50A	25-50mm/1-2"	±4µm	53.5	Ø5	

LARGE ANVIL MICROMETERS

- Graduation 0.01mm
- Ratchet stop
- Supplied with setting standards (except 0-25mm)



3234-25A



Code	Range	Accuracy	L	(mm)		
				a	b	
3234-25A	0-25mm	4µm	42	50	26	
3234-50A	25-50mm	4µm	67	60	38	

DATA
OUTPUT

IP65
WATERPROOF

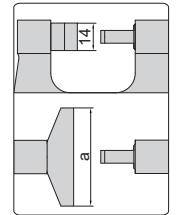
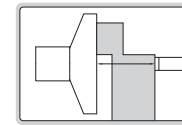
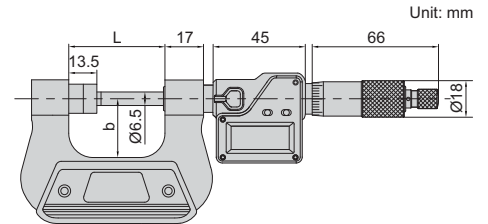
DIGITAL LARGE ANVIL MICROMETERS

5



3534-25A

- Resolution 0.001mm/0.00005"
- IP65 dust/waterproof
- Button function: on/off, set, mm/inch, ABS/INC
- Data output
- LR44 battery, automatic power off
- Ratchet stop
- Supplied with setting standards (except 0-25mm/0-1")
- Optional accessory: data output cable (code 7315-30, 7302-30)



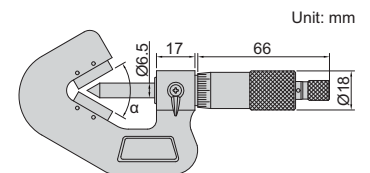
Code	Range	Accuracy	L	a	b
3534-25A	0-25mm/0-1"	±4µm	42mm	50mm	26mm
3534-50A	25-50mm/1-2"	±4µm	67mm	60mm	38mm

V-ANVIL MICROMETERS



3290-153A

- Measure the diameter of parts or cutting tools with odd grooves, such as taps, reamers and end mills
- Graduation 0.01mm
- Ratchet stop
- Carbide measuring faces
- Supplied with setting standards



Code	Range	Flutes	Accuracy	α
3290-153A	1-15mm	3	4µm	60°
3290-203A	5-20mm	3	4µm	60°
3290-353A	20-35mm	3	5µm	60°
3290-503A	35-50mm	3	5µm	60°
3290-653A	50-65mm	3	6µm	60°
3290-803A	65-80mm	3	6µm	60°
3290-953A	80-95mm	3	7µm	60°
3290-255A	5-25mm	5	4µm	108°

Code	Range	Flutes	Accuracy	α
3290-455A	25-45mm	5	5µm	108°
3290-655A	45-65mm	5	6µm	108°
3290-855A	65-85mm	5	7µm	108°
3290-1055A	85-105mm	5	8µm	108°
3290-257A	5-25mm	7	4µm	128°34'17"
3290-457A	25-45mm	7	5µm	128°34'17"
3290-657A	45-65mm	7	6µm	128°34'17"
3290-857A	65-85mm	7	7µm	128°34'17"

DIGITAL V-ANVIL MICROMETERS

IP65
WATERPROOF

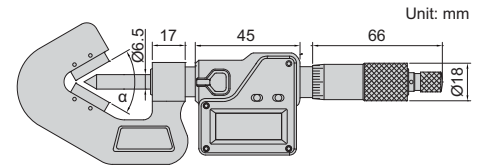
DATA
OUTPUT

5

- Measure the diameter of parts or cutting tools with odd grooves, such as taps, reamers and end mills
- Resolution 0.001mm/0.00005"
- IP65 dust/waterproof
- Button function: on/off, set, mm/inch, ABS/INC
- Data output
- LR44 battery, automatic power off
- Ratchet stop
- Carbide measuring faces
- Supplied with setting standards
- Optional accessory: data output cable (code 7315-30, 7302-30)



3590-153A

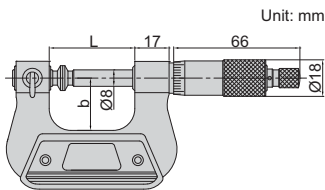


Code	Range	Flutes	Accuracy	α
3590-153A	1-15mm/0.04-0.6"	3	$\pm 4\mu\text{m}$	60°
3590-203A	5-20mm/0.2-0.8"	3	$\pm 4\mu\text{m}$	60°
3590-353A	20-35mm/0.8-1.4"	3	$\pm 5\mu\text{m}$	60°
3590-503A	35-50mm/1.4-2.0"	3	$\pm 5\mu\text{m}$	60°
3590-653A	50-65mm/2.0-2.6"	3	$\pm 6\mu\text{m}$	60°
3590-803A	65-80mm/2.6-3.2"	3	$\pm 6\mu\text{m}$	60°
3590-953A	80-95mm/3.2-3.6"	3	$\pm 6\mu\text{m}$	60°
3590-255A	5-25mm/0.2-1.0"	5	$\pm 4\mu\text{m}$	108°

Code	Range	Flutes	Accuracy	α
3590-455A	25-45mm/1.0-1.8"	5	$\pm 5\mu\text{m}$	108°
3590-655A	45-65mm/1.8-2.6"	5	$\pm 6\mu\text{m}$	108°
3590-855A	65-85mm/2.6-3.4"	5	$\pm 6\mu\text{m}$	108°
3590-1055A	85-105mm/3.4-4.2"	5	$\pm 6\mu\text{m}$	108°
3590-257A	5-25mm/0.2-1.0"	7	$\pm 4\mu\text{m}$	128°34'17"
3590-457A	25-45mm/1.0-1.8"	7	$\pm 4\mu\text{m}$	128°34'17"
3590-657A	45-65mm/1.8-2.6"	7	$\pm 5\mu\text{m}$	128°34'17"
3590-857A	65-85mm/2.6-3.4"	7	$\pm 5\mu\text{m}$	128°34'17"

NON-ROTATING SPINDLE UNIVERSAL MICROMETERS

NON-ROTATING
SPINDLE



3280-25A

- Meet DIN863-3
- Graduation 0.01mm
- Non-rotating spindle
- Ratchet stop
- Supplied with 7 pairs of anvil/spindle tip
- Setting standards are included (except 0-25mm)
- Optional accessory: 55° anvil/spindle tip (code 3280-SP1 and 3280-SP2)

Code	Range	Accuracy	L	b
3280-25A	0-25mm	4 μm	42mm	26mm
3280-50A	25-50mm	4 μm	67mm	38mm
3280-75A	50-75mm	5 μm	92mm	50mm
3280-100A	75-100mm	5 μm	118mm	62mm
3280-125A	100-125mm	6 μm	143mm	70mm
3280-150A	125-150mm	6 μm	168mm	82mm
3280-175A	150-175mm	7 μm	192mm	95mm
3280-200A	175-200mm	7 μm	217mm	107mm

Anvil/spindle tip (included)

Unit: mm

Flat		
Spherical		
Spline		
Disk		
Blade		
Knife-edge		
Point		

55° anvil/spindle tip (optional)

Unit: mm

Code 3280-SP1 Knife-edge		
Code 3280-SP2 Point		

DIGITAL UNIVERSAL MICROMETERS

Anvil/spindle tip (included) Unit: mm

Flat		
Spherical		
Spline		
Disk		
Blade		
Knife-edge		
Point		

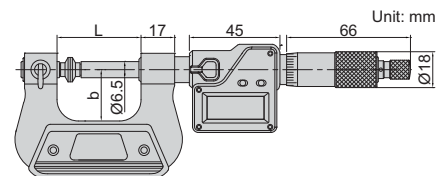
55° anvil/spindle tip (optional) Unit: mm

Code 3280-SP1 Knife-edge		
Code 3280-SP2 Point		

- Resolution 0.001mm/0.00005"
- Non-rotating spindle
- Button function: on/off, set, mm/inch, ABS/INC
- Data output
- LR44 battery
- Automatic power off
- Ratchet stop
- Supplied with 7 pairs of anvil/spindle tip
- Setting standards are included (except 0-25mm/0-1")
- Optional accessory: 55° anvil/spindle tip code 3280-SP1 and 3280-SP2, data output cable (code 7315-30, 7302-30)



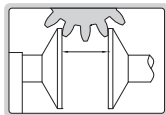
3580-25A



Code	Range	Accuracy	(mm)	
			L	b
3580-25A	0-25mm/0-1"	±4µm	42	26
3580-50A	25-50mm/1-2"	±4µm	67	38
3580-75A	50-75mm/2-3"	±5µm	92	50
3580-100A	75-100mm/3-4"	±5µm	118	62
3580-125A	100-125mm/4-5"	±6µm	143	70
3580-150A	125-150mm/5-6"	±6µm	168	82
3580-175A	150-175mm/6-7"	±7µm	192	95
3580-200A	175-200mm/7-8"	±7µm	217	107

ATTENTION: LOW PARALLELISM OF TWO MEASURING FACES

- Measure root tangent length of gear
- Graduation 0.01mm
- Ratchet stop
- Supplied with setting standards

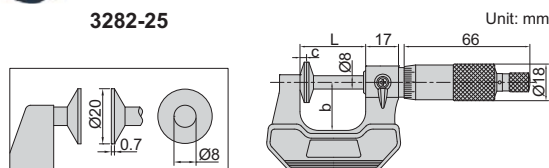


Code	Range	Accuracy	Parallelism	(mm)		
				L	b	c
3282-25	0-25mm	4µm	5µm	34	24	3.3
3282-50	25-50mm	4µm	5µm	59	32	3.3
3282-75	50-75mm	5µm	5µm	85	45	3.3
3282-100	75-100mm	5µm	5µm	110	57	3.3

DISK MICROMETERS (ECONOMIC TYPE)



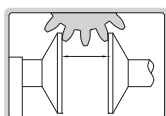
3282-25



ATTENTION: LOW PARALLELISM OF TWO MEASURING FACES

NON-ROTATING SPINDLE

- Measure root tangent length of gear
- Graduation 0.01mm
- Non-rotating spindle
- Ratchet stop
- Supplied with setting standards

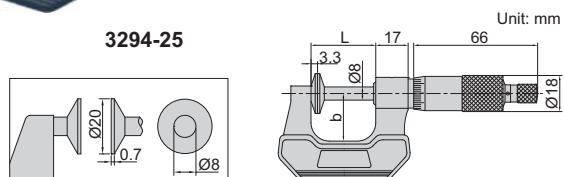


Code	Range	Accuracy	Parallelism	(mm)	
				L	b
3294-25	0-25mm	4µm	5µm	34	24
3294-50	25-50mm	4µm	5µm	59	32
3294-75	50-75mm	5µm	5µm	85	45
3294-100	75-100mm	5µm	5µm	110	57

NON-ROTATING SPINDLE DISK MICROMETERS (ECONOMIC TYPE)



3294-25



DIGITAL NON-ROTATING SPINDLE DISK MICROMETERS (ECONOMIC TYPE)

ATTENTION: LOW PARALLELISM OF TWO MEASURING FACES

DATA OUTPUT

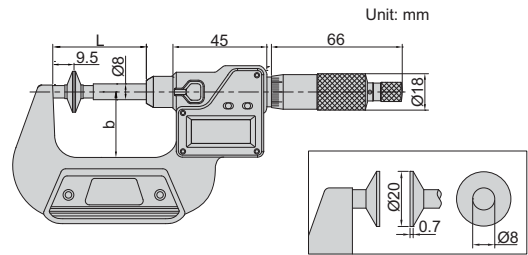
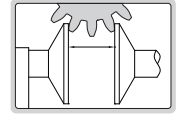
NON-ROTATING SPINDLE

5

- Measure root tangent length of gear
- Resolution 0.001mm/0.00005"
- Non-rotating spindle
- Button function: on/off, set, mm/inch, ABS/INC
- Data output
- LR44 battery, automatic power off
- Ratchet stop
- Supplied with setting standards
- Optional accessory: data output cable (code 7315-30, 7302-30)



3594-25A



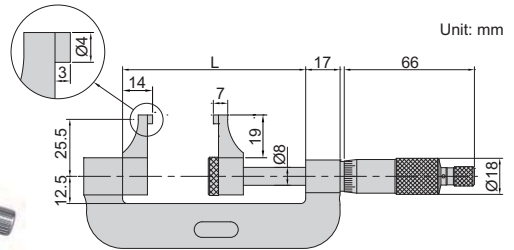
Code	Range	Accuracy	Parallelism	L	b
3594-25A	0-25mm/0-1"	±4μm	5μm	43mm	32mm
3594-50A	25-50mm/1-2"	±4μm	5μm	68mm	44.5mm
3594-75A	50-75mm/2-3"	±5μm	5μm	93mm	57mm
3594-100A	75-100mm/3-4"	±5μm	5μm	118.5mm	70mm

CALIPER TYPE MICROMETERS

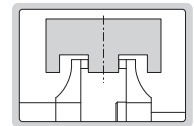
- Graduation 0.01mm
- Non-rotating spindle
- Ratchet stop
- Carbide measuring faces
- Supplied with setting standards (except 0-25mm)



3238-25



Code	Range	Accuracy	L
3238-25	0-25mm	10μm	56mm
3238-50	25-50mm	10μm	81mm
3238-75	50-75mm	11μm	106mm
3238-100	75-100mm	11μm	131mm

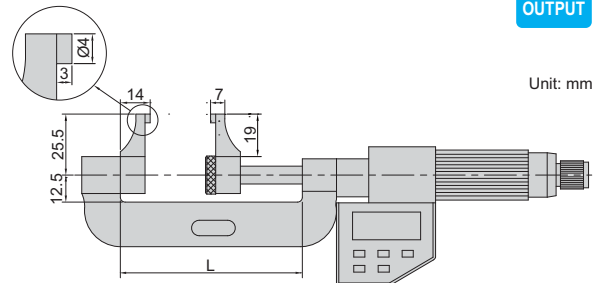


DIGITAL CALIPER TYPE MICROMETERS

DATA OUTPUT

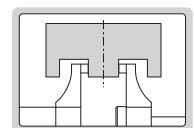


3538-25



Code	Range	Accuracy	L
3538-25	0-25mm/0-1"	±10μm	56mm
3538-50	25-50mm/1-2"	±10μm	81mm
3538-75	50-75mm/2-3"	±11μm	106mm
3538-100	75-100mm/3-4"	±11μm	131mm

- Resolution: 0.001mm/0.00005"
- Non-rotating spindle
- Buttons: on/off, data set, mm/in, ABS/INC
- Data output
- LR44 battery, automatic power off
- Ratchet friction thimble
- Carbide measuring faces
- Supplied with setting standards (except 0-25mm/0-1")
- Optional accessory: data output cable (code 7315-30, 7302-30)



NON-ROTATING SPINDLE

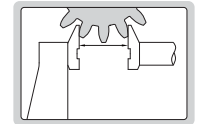
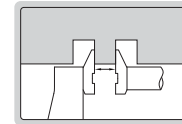
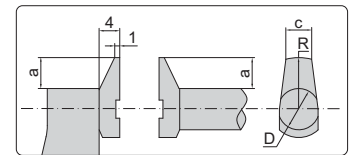
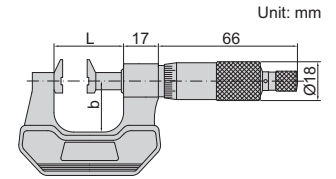
JAW TYPE MICROMETERS



3283-25A

- Graduation 0.01mm
- Non-rotating spindle
- Ratchet stop
- Supplied with setting standards (except 0-25mm)

Code	Range	Accuracy	L	a	b	c	R	D
3283-25A	0-25mm	4μm	34	6	24	5	10	8
3283-50A	25-50mm	4μm	59	6	32	5	10	8
3283-75A	50-75mm	5μm	85	6	45	5	10	8
3283-100A	75-100mm	5μm	110	6	57	5	10	8
3283-125A	100-125mm	6μm	138	9	70	8	15	12
3283-150A	125-150mm	6μm	163	9	82	8	15	12
3283-175A	150-175mm	7μm	188	9	95	8	15	12
3283-200A	175-200mm	7μm	214	9	107	8	15	12



5

DATA OUTPUT

NON-ROTATING SPINDLE

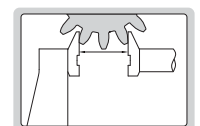
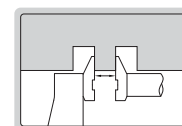
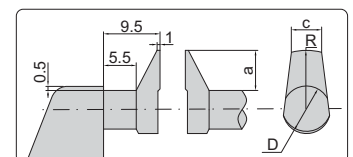
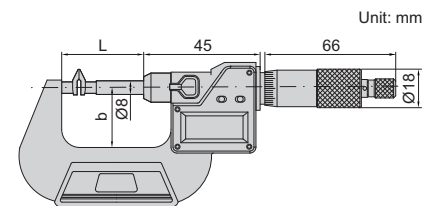
DIGITAL JAW TYPE MICROMETERS



3583-25A

- Resolution 0.001mm/0.00005"
- Non-rotating spindle
- Button function: on/off, set, mm/inch, ABS/INC
- Data output
- LR44 battery, automatic power off
- Ratchet stop
- Supplied with setting standards (except 0-25mm/0-1")
- Optional accessory: data output cable (code 7315-30, 7302-30)

Code	Range	Accuracy	L	a	b	c	R	D
3583-25A	0-25mm/0-1"	±4μm	43	6.5	32	5	10	8
3583-50A	25-50mm/1-2"	±4μm	85	6.5	44.5	5	10	8
3583-75A	50-75mm/2-3"	±5μm	110	6.5	57	5	10	8
3583-100A	75-100mm/3-4"	±5μm	135	6.5	70	5	10	8
3583-125A	100-125mm/4-5"	±6μm	160	11.5	86	8	15	12
3583-150A	125-150mm/5-6"	±6μm	186	11.5	94.5	8	15	12
3583-175A	150-175mm/6-7"	±7μm	211	11.5	107	8	15	12
3583-200A	175-200mm/7-8"	±7μm	236	11.5	120	8	15	12

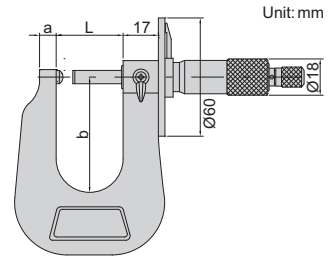
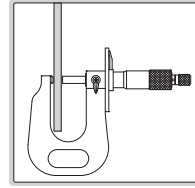


SHEET METAL MICROMETERS

- Meet DIN863-3
- Measure thickness of sheet metal, paper, plastic and rubber parts
- Graduation 0.01mm
- Ratchet stop
- Carbide measuring faces

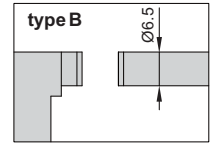
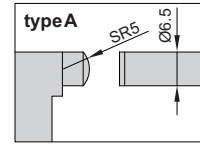


3263-25A



Code	Range	Type	Accuracy	L	a	b
3263-15A	0-15mm	A	4µm	22	8	50
3263-25A	0-25mm	A	4µm	32	8	50
3263-50A	0-50mm	A	5µm	57	12	100
3263-15B	0-15mm	B	4µm	22	8	50
3263-25B	0-25mm	B	4µm	32	8	50
3263-50B	0-50mm	B	5µm	57	12	100

(mm)



MICROMETERS FOR HOT PLATE

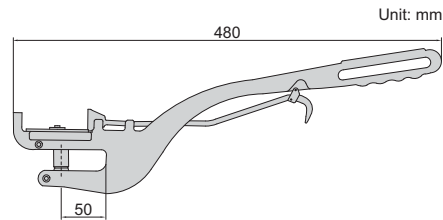
- Measure thickness of hot rolling sheet metal
- Carbide measuring faces
- Supplied with setting standard (except 0-15mm)



3264-15



Code	Range	Graduation	Accuracy
3264-15	0-15mm	0.05mm	0.05mm
3264-30	15-30mm	0.05mm	0.05mm
3264-45	30-45mm	0.05mm	0.05mm
3264-60	45-60mm	0.05mm	0.05mm
3264-75	60-75mm	0.05mm	0.05mm
3264-90	75-90mm	0.05mm	0.05mm
3264-105	90-105mm	0.05mm	0.05mm



HUB MICROMETERS

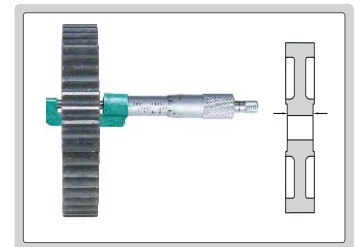
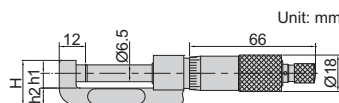
- Meet DIN863-3
- Measure hub thickness and shoulder inside a bore
- Graduation 0.01mm
- Ratchet stop
- Carbide measuring faces
- Supplied with setting standards (except 0-25mm)



3292-25

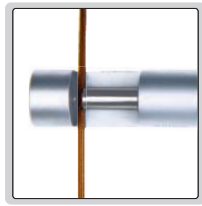
Code	Range	Accuracy	h1	h2	H
3292-25	0-25mm	4µm	6	9	18.7
3292-50	25-50mm	4µm	6.5	11	21.2
3292-75	50-75mm	5µm	6.5	11	21.2
3292-100	75-100mm	5µm	6.5	11	21.2

(mm)

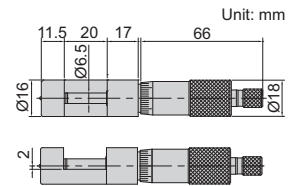


WIRE MICROMETER

- Meet DIN863-3
- Measure diameter of wires and small balls
- Graduation 0.01mm
- Ratchet stop
- Carbide measuring faces



3285-10



Code	Range	Accuracy
3285-10	0-10mm	4µm

CAN SEAM MICROMETERS



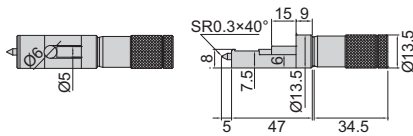
3293-131



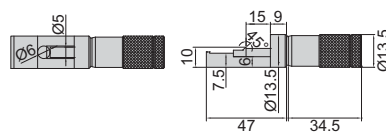
3293-132



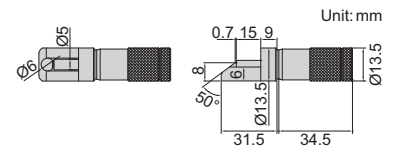
3293-133



3293-131



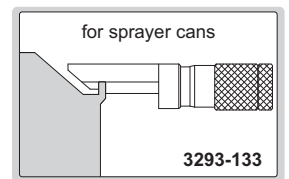
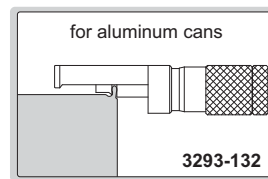
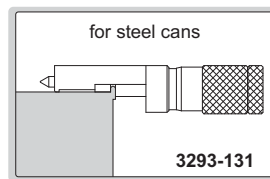
3293-132



3293-133

- Measure the width, height and depth of can seams
- Graduation 0.01mm

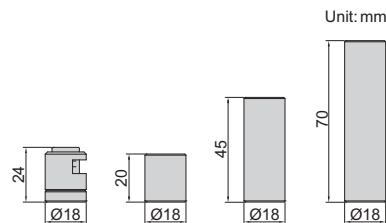
Code	Range	Accuracy
3293-131	0-13mm	4µm
3293-132	0-13mm	4µm
3293-133	0-13mm	4µm



MICROMETER MEASURING FORCE DETECTOR



6315



- For outside micrometers 0-25mm/0-1", 25-50mm/1-2", 50-75mm/2-3" and 75-100mm/3-4"

Code	Measuring force
6315	5-12N

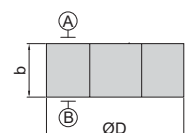
OPTICAL PARALLELS

- Check the flatness and parallelism of measuring faces of micrometer
- Flatness of A and B: 0.1µm
- Parallelism between A and B: 0.6µm



4184-41A

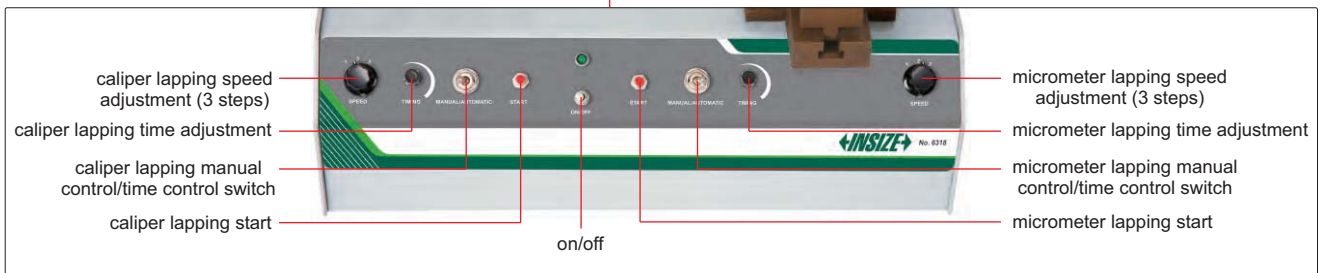
Code	Parallels included (b)	ØD	Applicable micrometer
4184-41A	15.62mm, 15.75mm, 15.87mm, 16.00mm	30mm	0-25mm
4184-42A	40.62mm, 40.75mm, 40.87mm, 41.00mm	30mm	25-50mm
4184-43B	65.62mm, 65.75mm, 65.87mm, 66.00mm	40mm	50-75mm
4184-44B	90.62mm, 90.75mm, 90.87mm, 91.00mm	50mm	75-100mm



CALIPER/MICROMETER LAPPING MACHINE CODE 6318



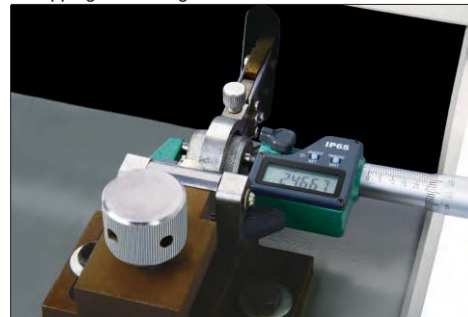
5



lapping measuring surfaces of caliper lower jaws



lapping measuring surfaces of outside micrometer



- For lapping measuring surfaces of caliper lower jaws and outside micrometer
- Suitable for 0-300mm range calipers and 0-100mm range outside micrometers

caliper lapping block (included)



micrometer lapping blocks (code: 6307-1, optional)



SPECIFICATION

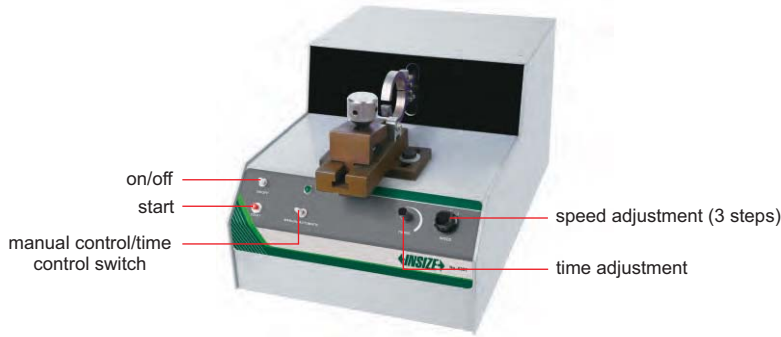
Power supply	220V, 50/60Hz
Dimension (L×W×H)	430×400×210mm
Weight	28kg

MICROMETER LAPPING BLOCKS (optional)

Code	For micrometer	Remark
6307-1	0~25mm	includes 4 lapping blocks
6307-2	25~50mm	includes 4 lapping blocks
6307-3	50~75mm	includes 4 lapping blocks
6307-4	75~100mm	includes 4 lapping blocks



MICROMETER LAPPING MACHINE CODE 6307



lapping blocks (code: 6307-1, optional)



- Used for lapping micrometer measuring surfaces
- Suitable for 0~100mm range micrometers

SPECIFICATION

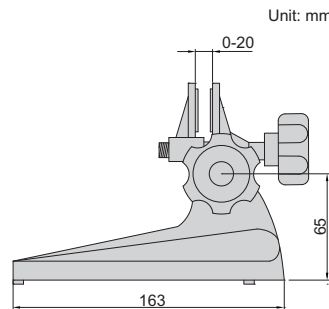
Power supply	220V, 50/60HZ
Dimension (L×W×H)	450×260×220mm
Weight	30kg

LAPPING BLOCKS (optional)

Code	For micrometer	Remark
6307-1	0~25mm	includes 4 lapping blocks
6307-2	25~50mm	includes 4 lapping blocks
6307-3	50~75mm	includes 4 lapping blocks
6307-4	75~100mm	includes 4 lapping blocks

MICROMETER STAND

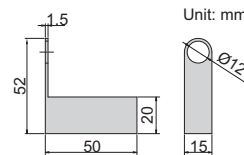
- Suitable for outside micrometers up to 100mm



6301

Code
6301

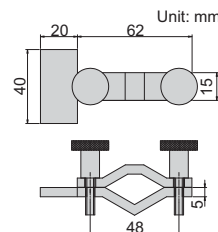
- Suitable for inside micrometers



6301-1

Code	Description	Applicable products
6301-1	clamp for inside micrometers	all sizes of 3220 series

- Suitable for three points internal micrometers



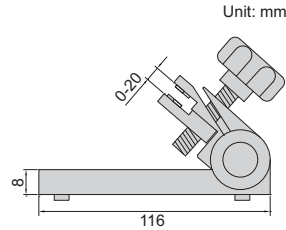
6301-2

Code	Description	Applicable products
6301-2	clamp for three points internal micrometers	up to 100mm of 3127 and 3227 series

MICROMETER STAND

- Suitable for outside micrometers up to 100mm

Code
6300

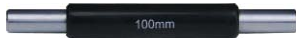


6300



5

MICROMETER SETTING STANDARDS



6310-100



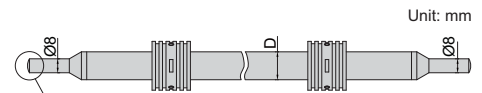
type A



6310-300

Code	Length	Type	Accuracy	D
6310-25	25	A	±1.5µm	Ø7
6310-50	50	A	±2µm	Ø7
6310-75	75	A	±2.5µm	Ø7
6310-100	100	A	±3µm	Ø8
6310-125	125	A	±3.5µm	Ø8
6310-150	150	A	±4µm	Ø8
6310-175	175	A	±4.5µm	Ø8
6310-200	200	A	±5µm	Ø8
6310-225	225	A	±5.5µm	Ø8
6310-250	250	A	±6µm	Ø8
6310-275	275	A	±6.5µm	Ø8
6310-300	300	B	±7µm	Ø16
6310-325	325	B	±7.5µm	Ø16
6310-350	350	B	±8µm	Ø16
6310-375	375	B	±8.5µm	Ø16

Code	Length	Type	Accuracy	D
6310-400	400	B	±9µm	Ø16
6310-425	425	B	±9.5µm	Ø16
6310-450	450	B	±10µm	Ø16
6310-475	475	B	±10.5µm	Ø16
6310-500	500	B	±11µm	Ø16
6310-525	525	B	±11.5µm	Ø16
6310-575	575	B	±12.5µm	Ø16
6310-625	625	B	±13.5µm	Ø16
6310-675	675	B	±14.5µm	Ø16
6310-725	725	B	±15.5µm	Ø16
6310-775	775	B	±16.5µm	Ø16
6310-825	825	B	±17.5µm	Ø16
6310-875	875	B	±18.5µm	Ø16
6310-925	925	B	±19.5µm	Ø16
6310-975	975	B	±20.5µm	Ø16



type B

Code	Length	Type	Accuracy	D
6310-1050	1050	B	±22µm	Ø23
6310-1150	1150	B	±24µm	Ø23
6310-1250	1250	B	±26µm	Ø23
6310-1350	1350	B	±28µm	Ø23
6310-1450	1450	B	±30µm	Ø23
6310-1550	1550	B	±32µm	Ø23
6310-1650	1650	B	±34µm	Ø23
6310-1750	1750	B	±36µm	Ø23
6310-1850	1850	B	±38µm	Ø23
6310-1950	1950	B	±40µm	Ø23

DIGITAL MICROMETER HEADS

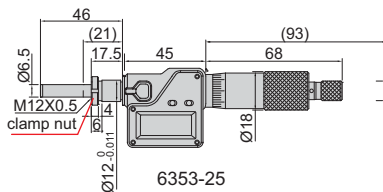
- Resolution 0.001mm/0.00005"
- IP65 dust/waterproof
- Button function: on/off, set, mm/inch, ABS/INC
- Data output
- LR44 battery, automatic power off
- Ratchet stop
- Optional accessory: data output cable (code 7315-30, 7302-30)



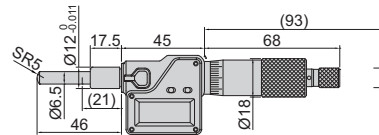
6353-25W

IP65
WATERPROOF

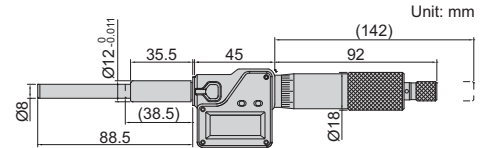
DATA
OUTPUT



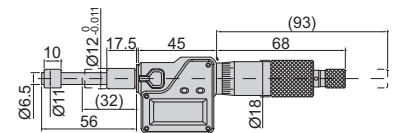
6353-25



6353-25WS



6353-50W



6354-25W

Rotating spindle

Code	Range	Stem	Spindle tip	Accuracy
6353-25	0-25mm/0-1"	with clamp nut	flat (carbide)	±2µm
6353-25W	0-25mm/0-1"	plain	flat (carbide)	±2µm
6353-25S	0-25mm/0-1"	with clamp nut	spherical (SR5)	±2µm
6353-25WS	0-25mm/0-1"	plain	spherical (SR5)	±2µm
6353-50W	0-50mm/0-2"	plain	flat (carbide)	±4µm

Non-rotating spindle

Code	Range	Stem	Spindle tip	Accuracy
6354-25W	0-25mm/0-1"	plain	flat	±2µm

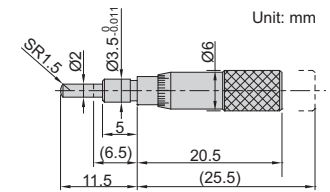
SMALL MICROMETER HEAD

- Graduation 0.02mm

Code	Range	Stem	Spindle tip	Accuracy
6372-5WS	0-5mm	plain	spherical (SR1.5)	5µm



6372-5WS



5

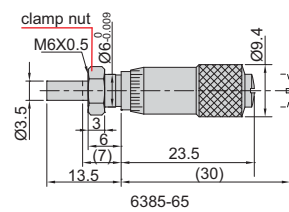
SMALL MICROMETER HEADS

- Range 0-6.5mm
- Graduation 0.01mm
- Accuracy 5µm

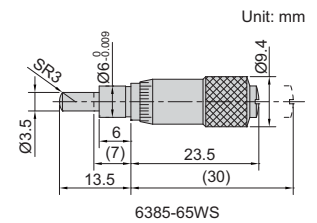


6385-65W

Code	Stem	Spindle tip
6385-65	with clamp nut	flat
6385-65W	plain	flat
6385-65S	with clamp nut	spherical (SR3)
6385-65WS	plain	spherical (SR3)



6385-65

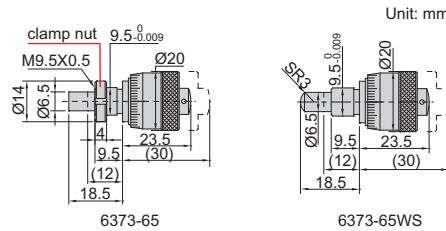


6385-65WS

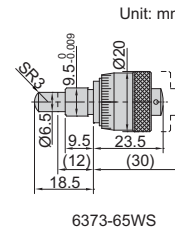
LARGE THIMBLE MICROMETER HEADS

- Meet DIN863-2
- Large thimble diameter for easy reading
- Graduation 0.01mm
- Accuracy 3µm

Code	Range	Stem	Spindle tip
6373-65	0-6.5mm	with clamp nut	flat
6373-65W	0-6.5mm	plain	flat
6373-65S	0-6.5mm	with clamp nut	spherical (SR3)
6373-65WS	0-6.5mm	plain	spherical (SR3)
6373-13	0-13mm	with clamp nut	flat
6373-13W	0-13mm	plain	flat



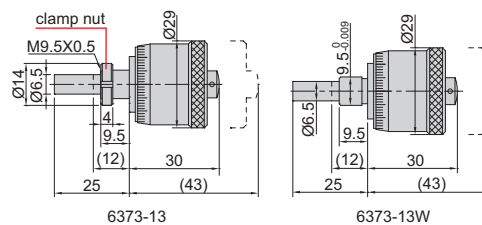
6373-65



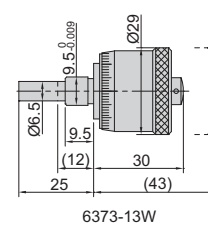
6373-65WS



6373-65



6373-13



6373-13W

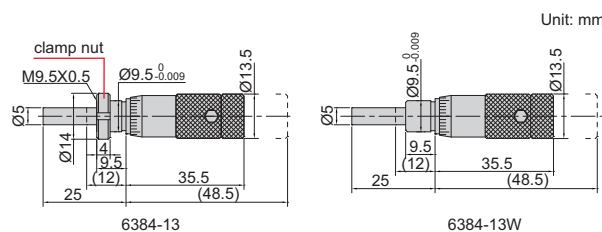


6373-13

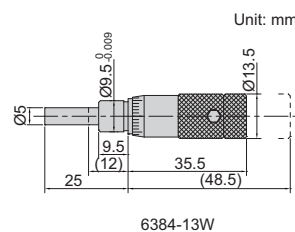
MICROMETER HEADS WITH ZERO ADJUSTABLE THIMBLE

- Meet DIN863-2
- Range 0-13mm
- Graduation 0.01mm
- Accuracy 3µm
- The thimble can be set to zero at any position

Code	Stem	Spindle tip
6384-13	with clamp nut	flat
6384-13W	plain	flat



6384-13



6384-13W

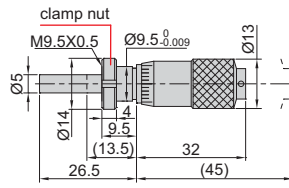


6384-13W

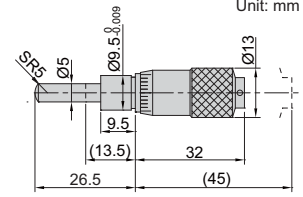
MICROMETER HEADS



6386-13W



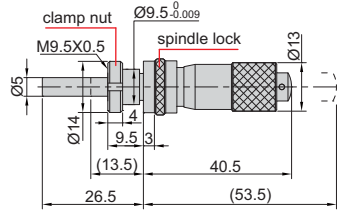
6386-13



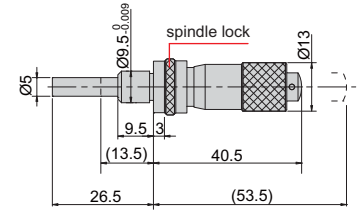
6386-13WS



6386-13P



6386-13P



6386-13WP

Unit: mm

Code	Range	Stem	Spindle tip	Remark	Accuracy
6386-13	0-13mm	with clamp nut	flat		3µm
6386-13W	0-13mm	plain	flat		3µm
6386-13S	0-13mm	with clamp nut	spherical (SR5)		3µm
6386-13WS	0-13mm	plain	spherical (SR5)		3µm
6386-13P	0-13mm	with clamp nut	flat	with spindle lock	3µm
6386-13WP	0-13mm	plain	flat	with spindle lock	3µm

- Meet DIN863-2
- Graduation 0.01mm

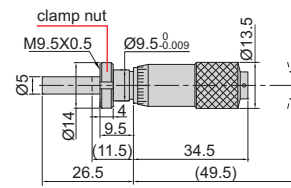
MICROMETER HEADS

- Meet DIN863-2
- Graduation 0.01mm
- Accuracy 3µm

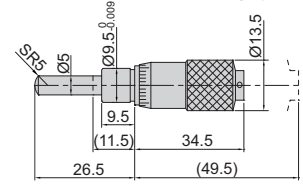


6387-15WS

Code	Range	Stem	Spindle tip
6387-15	0-15mm	with clamp nut	flat
6387-15W	0-15mm	plain	flat
6387-15S	0-15mm	with clamp nut	spherical (SR5)
6387-15WS	0-15mm	plain	spherical (SR5)



6387-15



6387-15WS

Unit: mm

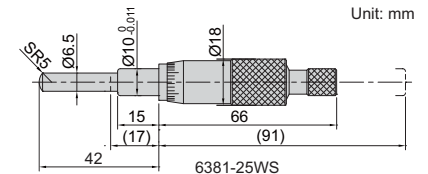
MICROMETER HEADS



6381-25

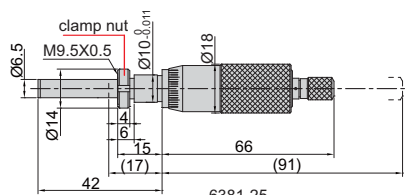


6381-25P

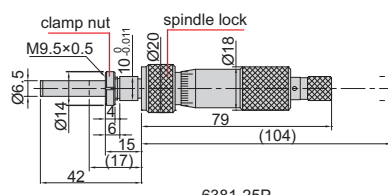


6381-25WS

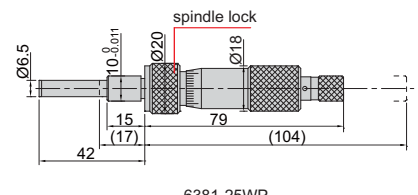
Unit: mm



6381-25



6381-25P



6381-25WP

Code	Range	Stem	Spindle tip	Remark	Accuracy
6381-25	0-25mm	with clamp nut	flat (carbide)		3µm
6381-25W	0-25mm	plain	flat (carbide)		3µm
6381-25S	0-25mm	with clamp nut	spherical (SR5)		3µm
6381-25WS	0-25mm	plain	spherical (SR5)		3µm
6381-25P	0-25mm	with clamp nut	flat (carbide)	with spindle lock	3µm
6381-25WP	0-25mm	plain	flat (carbide)	with spindle lock	3µm

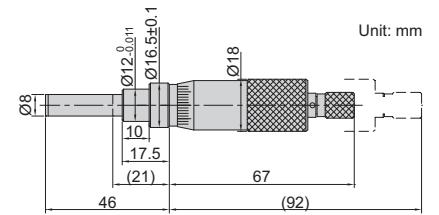
- Meet DIN863-2
- Graduation 0.01mm
- Ratchet stop

NON-ROTATING SPINDLE MICROMETER HEAD

- Meet DIN863-2
- Graduation 0.01mm
- Ratchet stop
- Non-rotating spindle



6377-25W



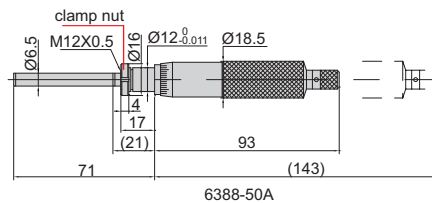
Code	Range	Stem	Spindle tip	Accuracy
6377-25W	0-25mm	plain	flat (carbide)	3µm

LARGE MICROMETER HEADS

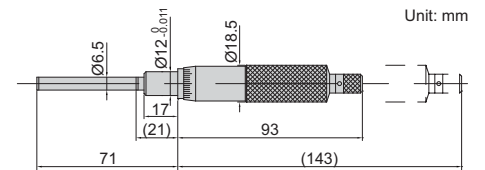
- Graduation 0.01mm
- Ratchet stop



6388-50AW



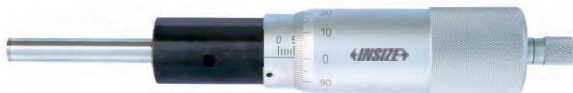
6388-50A



6388-50AW

Code	Range	Stem	Spindle tip	Accuracy
6388-50A	0-50mm	with clamp nut	flat (carbide)	5µm
6388-50AW	0-50mm	plain	flat (carbide)	5µm

QUICK SPINDLE FEEDING MICROMETER HEADS



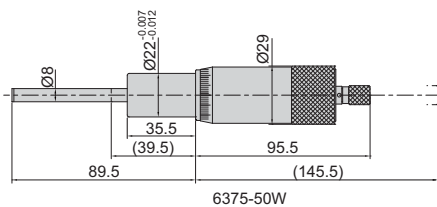
6375-50W



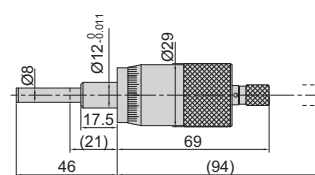
6375-25W



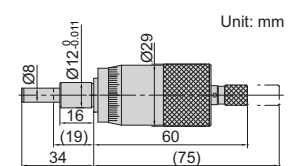
6375-15W



6375-50W



6375-25W



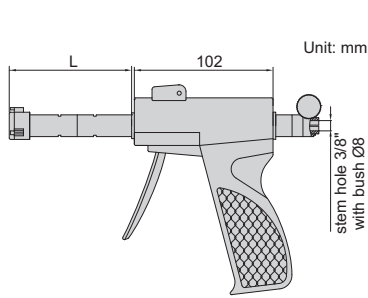
6375-15W

Code	Range	Stem	Spindle tip	Accuracy
6375-15W	0-15mm	plain	flat (carbide)	3µm
6375-25W	0-25mm	plain	flat (carbide)	3µm
6375-50W	0-50mm	plain	flat (carbide)	5µm

- Micrometers up to 25mm meet DIN863-2
- Graduation 0.01mm
- Quick spindle feed of 1mm/rev.
- Ratchet stop

PISTOL GRIP THREE POINTS BORE GAGES

**INSPECTION
CERTIFICATE**



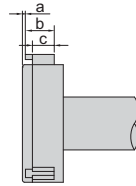
- Optional accessory:
digital indicators (code **2108-101F**, resolution 0.001mm/0.00005"),
setting rings (code **6312**)



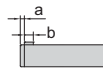
6-100mm: included
100-300mm: **optional**



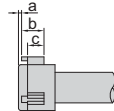
included



Type C
50-300mm, carbide
measuring points



Type A
6-12mm, steel
measuring points



Type B
12-50mm, carbide
measuring points



Individual

Code	Range	Type	Accuracy (without digital indicator)	Setting ring	Extension rod (included)	L	a	b	c
2124-8 *	6-8mm	A	4µm	Ø6mm (included)	100mm	50	1.5	2.5	—
2124-10 *	8-10mm	A	4µm	Ø8mm (included)	100mm	50	1.5	2.5	—
2124-12 *	10-12mm	A	4µm	Ø10mm (included)	100mm	50	1.5	2.5	—
2124-16 *	12-16mm	B	4µm	Ø16mm (included)	150mm	65	0.5	6	4.5
2124-20 *	16-20mm	B	4µm	Ø16mm (included)	150mm	65	0.5	6	4.5
2124-25 *	20-25mm	B	4µm	Ø25mm (included)	150mm	91	0.5	8	6
2124-30 *	25-30mm	B	4µm	Ø25mm (included)	150mm	91	0.5	8	6
2124-40 *	30-40mm	B	4µm	Ø40mm (included)	150mm	97	0.5	14	12
2124-50 *	40-50mm	B	5µm	Ø40mm (included)	150mm	97	0.5	14	12
2124-63 *	50-63mm	C	5µm	Ø62mm (included)	150mm	112	0.5	17.5	14.5
2124-75 *	62-75mm	C	5µm	Ø62mm (included)	150mm	112	0.5	17.5	14.5
2124-88 *	75-88mm	C	5µm	Ø87mm (included)	150mm	112	0.5	17.5	14.5
2124-100 *	87-100mm	C	5µm	Ø87mm (included)	150mm	112	0.5	17.5	14.5
2124-125 *	100-125mm	C	6µm	optional	150mm	140	0.9	29	25
2124-150 *	125-150mm	C	6µm	optional	150mm	140	0.9	29	25
2124-175 *	150-175mm	C	7µm	optional	150mm	140	0.9	29	25
2124-200 *	175-200mm	C	7µm	optional	150mm	140	0.9	29	25
2124-225	200-225mm	C	8µm	optional	150mm	140	0.9	29	25
2124-250	225-250mm	C	8µm	optional	150mm	140	0.9	29	25
2124-275	250-275mm	C	9µm	optional	150mm	140	0.9	29	25
2124-300	275-300mm	C	9µm	optional	150mm	140	0.9	29	25

Set

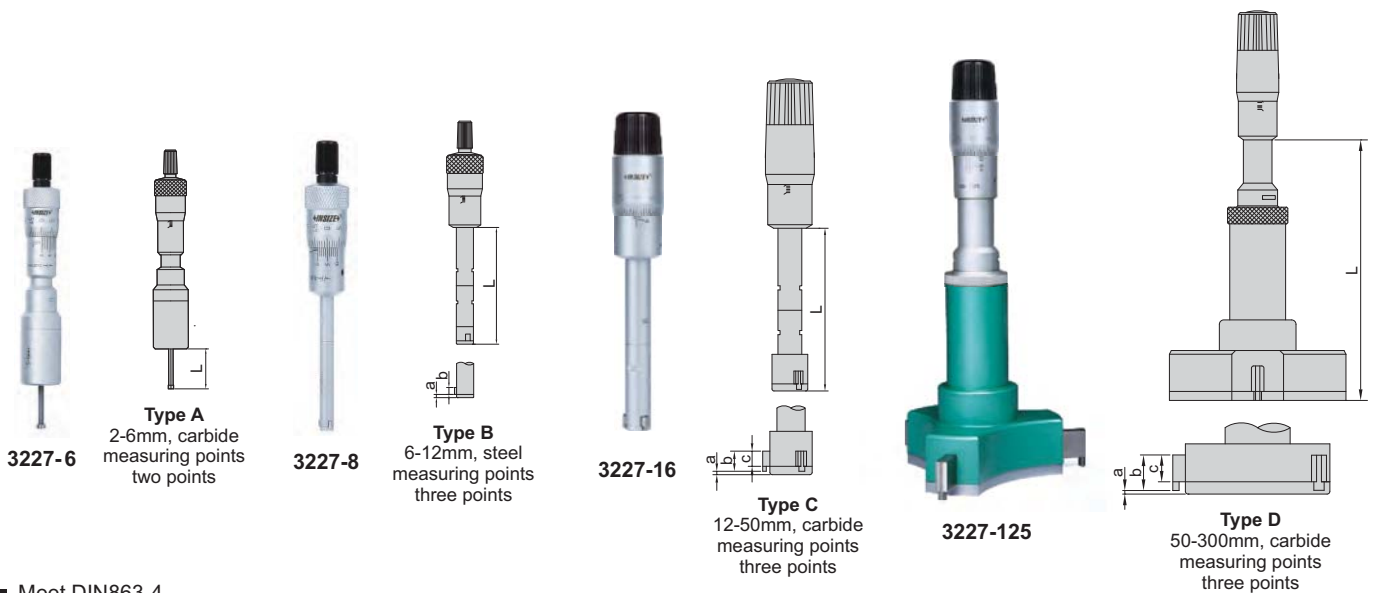
Code	Range	Probes included	Setting ring (included)	Extension rod (included)
2124-S123 *	6-12mm	6-8mm, 8-10mm, 10-12mm	Ø6mm, Ø8mm, Ø10mm	100mm
2124-S202 *	12-20mm	12-16mm, 16-20mm	Ø16mm	150mm
2124-S504 *	20-50mm	20-25mm, 25-30mm, 30-40mm, 40-50mm	Ø25mm, Ø40mm	150mm
2124-S1004 *	50-100mm	50-63mm, 62-75mm, 75-88mm, 87-100mm	Ø62mm, Ø87mm	150mm



2124- S504

* Supplied with manufacturer inspection certificate

TWO POINTS/THREE POINTS INTERNAL MICROMETERS



- Meet DIN863-4
- 2-12mm: graduation 0.001mm
12-300mm: graduation 0.005mm
- Ratchet stop
- Optional accessory: setting rings (code **6312**), micrometer stand and clamp (code **6301** and **6301-2**)

Individual

(mm)

Code	Range	Type	Accuracy	Setting ring	Extension rod (included)	L	a	b	c
3227-2 *	2-2.5mm	A (two points)	6µm	Ø2.5 (included)	—	12	—	—	—
3227-3 *	2.5-3mm	A (two points)	6µm	Ø2.5 (included)	—	12	—	—	—
3227-4 *	3-4mm	A (two points)	6µm	Ø4 (included)	—	22	—	—	—
3227-5 *	4-5mm	A (two points)	6µm	Ø5 (included)	—	22	—	—	—
3227-6 *	5-6mm	A (two points)	6µm	Ø6 (included)	—	22	—	—	—
3227-8 *	6-8mm	B (three points)	4µm	Ø6 (included)	100	54.5	1.5	2.5	—
3227-10 *	8-10mm	B (three points)	4µm	Ø8 (included)	100	54.5	1.5	2.5	—
3227-12 *	10-12mm	B (three points)	4µm	Ø10 (included)	100	54.5	1.5	2.5	—
3227-16 *	12-16mm	C (three points)	4µm	Ø16 (included)	150	80	0.5	6	4.5
3227-20 *	16-20mm	C (three points)	4µm	Ø16 (included)	150	80	0.5	6	4.5
3227-25 *	20-25mm	C (three points)	4µm	Ø25 (included)	150	90	0.5	8	6
3227-30 *	25-30mm	C (three points)	4µm	Ø25 (included)	150	90	0.5	8	6
3227-40 *	30-40mm	C (three points)	4µm	Ø40 (included)	150	97	0.5	14	12
3227-50 *	40-50mm	C (three points)	5µm	Ø40 (included)	150	97	0.5	14	12
3227-63 *	50-63mm	D (three points)	5µm	Ø62 (included)	150	114	0.5	17.5	14.5
3227-75 *	62-75mm	D (three points)	5µm	Ø62 (included)	150	114	0.5	17.5	14.5
3227-88 *	75-88mm	D (three points)	5µm	Ø87 (included)	150	114	0.5	17.5	14.5
3227-100 *	87-100mm	D (three points)	5µm	Ø87 (included)	150	114	0.5	17.5	14.5
3227-125 *	100-125mm	D (three points)	6µm	optional	150	140	0.9	29	25
3227-150 *	125-150mm	D (three points)	6µm	optional	150	140	0.9	29	25
3227-175 *	150-175mm	D (three points)	7µm	optional	150	140	0.9	29	25
3227-200 *	175-200mm	D (three points)	7µm	optional	150	140	0.9	29	25
3227-225	200-225mm	D (three points)	8µm	optional	150	140	0.9	29	25
3227-250	225-250mm	D (three points)	8µm	optional	150	140	0.9	29	25
3227-275	250-275mm	D (three points)	9µm	optional	150	140	0.9	29	25
3227-300	275-300mm	D (three points)	9µm	optional	150	140	0.9	29	25

To be continued

Continued from previous page

micrometer stand with clamp (optional)

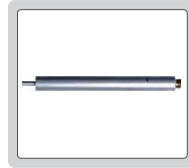


setting ring



2-100mm: included
100-300mm: optional

extension rod



included



3227-504

6

Set

Code	Range	Micrometers included	Setting ring (included)	Extension rod (included)
3227-232 *	2-3mm	2-2.5mm, 2.5-3mm	Ø2.5mm	—
3227-363 *	3-6mm	3-4mm, 4-5mm, 5-6mm	Ø4mm, Ø5mm, Ø6mm	—
3227-123 *	6-12mm	6-8mm, 8-10mm, 10-12mm	Ø6mm, Ø8mm, Ø10mm	100mm
3227-202 *	12-20mm	12-16mm, 16-20mm	Ø16mm	150mm
3227-504 *	20-50mm	20-25mm, 25-30mm, 30-40mm, 40-50mm	Ø25mm, Ø40mm	150mm
3227-1004 *	50-100mm	50-63mm, 62-75mm, 75-88mm, 87-100mm	Ø62mm, Ø87mm	150mm

* Supplied with manufacturer inspection certificate

DIGITAL TWO POINTS/THREE POINTS INTERNAL MICROMETERS



IP65
WATERPROOF

DATA
OUTPUT



3127-5

Type A
2-6mm, carbide measuring points two points



3127-12

Type B
6-12mm, steel measuring points three points



3127-40

Type C
12-50mm, carbide measuring points three points



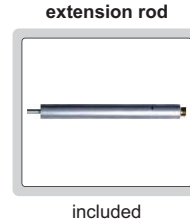
3127-125

Type D
50-300mm, carbide measuring points three points

- Resolution 0.001mm/0.00005" (resolution of 3127-275 and 3127-300 is 0.001mm/0.0001")
- IP65 dust/waterproof
- Buttons: on/off, set, mm/inch, ABS/INC
- Data output
- LR44 battery, automatic power off
- Ratchet stop
- Optional accessory: data output cable (code 7315-30, 7302-30), setting ring (code 6312), micrometer stand and clamp (code 6301 and 6301-2)

To be continued

Continued from previous page



3127-202

Individual

(mm)

Code	Range	Type	Accuracy	Setting ring	Extension rod (included)	L	a	b	c
3127-2 *	2-2.5mm/0.08-0.10"	A (two points)	6µm	Ø2.5 (included)	—	12	—	—	—
3127-3 *	2.5-3mm/0.10-0.12"	A (two points)	6µm	Ø2.5 (included)	—	12	—	—	—
3127-4 *	3-4mm/0.12-0.16"	A (two points)	6µm	Ø4 (included)	—	22	—	—	—
3127-5 *	4-5mm/0.16-0.20"	A (two points)	6µm	Ø5 (included)	—	22	—	—	—
3127-6 *	5-6mm/0.20-0.24"	A (two points)	6µm	Ø6 (included)	—	22	—	—	—
3127-8 *	6-8mm/0.24-0.31"	B (three points)	4µm	Ø6 (included)	100	57	1.5	2.5	—
3127-10 *	8-10mm/0.31-0.39"	B (three points)	4µm	Ø8 (included)	100	57	1.5	2.5	—
3127-12 *	10-12mm/0.39-0.47"	B (three points)	4µm	Ø10 (included)	100	57	1.5	2.5	—
3127-16 *	12-16mm/0.47-0.63"	C (three points)	4µm	Ø16 (included)	150	99	0.5	6	4.5
3127-20 *	16-20mm/0.63-0.79"	C (three points)	4µm	Ø16 (included)	150	99	0.5	6	4.5
3127-25 *	20-25mm/0.79-0.98"	C (three points)	4µm	Ø25 (included)	150	105	0.5	8	6
3127-30 *	25-30mm/0.98-1.18"	C (three points)	4µm	Ø25 (included)	150	105	0.5	8	6
3127-40 *	30-40mm/1.18-1.57"	C (three points)	4µm	Ø40 (included)	150	110	0.5	14	12
3127-50 *	40-50mm/1.57-1.97"	C (three points)	5µm	Ø40 (included)	150	110	0.5	14	12
3127-63 *	50-63mm/1.97-2.48"	D (three points)	5µm	Ø62 (included)	150	127	0.5	17.5	14.5
3127-75 *	62-75mm/2.44-2.95"	D (three points)	5µm	Ø62 (included)	150	127	0.5	17.5	14.5
3127-88 *	75-88mm/2.95-3.46"	D (three points)	5µm	Ø87 (included)	150	127	0.5	17.5	14.5
3127-100 *	87-100mm/3.43-3.94"	D (three points)	5µm	Ø87 (included)	150	127	0.5	17.5	14.5
3127-125 *	100-125mm/3.94-4.92"	D (three points)	6µm	optional	150	175	0.9	29	25
3127-150 *	125-150mm/4.92-5.91"	D (three points)	6µm	optional	150	175	0.9	29	25
3127-175 *	150-175mm/5.91-6.89"	D (three points)	7µm	optional	150	175	0.9	29	25
3127-200 *	175-200mm/6.89-7.87"	D (three points)	7µm	optional	150	175	0.9	29	25
3127-225	200-225mm/7.87-8.86"	D (three points)	8µm	optional	150	175	0.9	29	25
3127-250	225-250mm/8.86-9.84"	D (three points)	8µm	optional	150	175	0.9	29	25
3127-275	250-275mm/9.84-10.83"	D (three points)	9µm	optional	150	175	0.9	29	25
3127-300	275-300mm/10.83-11.81"	D (three points)	9µm	optional	150	175	0.9	29	25

Set

Code	Range	Micrometers included	Setting ring (included)	Extension rod (included)
3127-232 *	2-3mm/0.08-0.12"	2-2.5mm, 2.5-3mm	Ø2.5mm	—
3127-363 *	3-6mm/0.12-0.24"	3-4mm, 4-5mm, 5-6mm	Ø4mm, Ø5mm, Ø6mm	—
3127-123 *	6-12mm/0.24-0.47"	6-8mm, 8-10mm, 10-12mm	Ø6mm, Ø8mm, Ø10mm	100mm
3127-202 *	12-20mm/0.47-0.79"	12-16mm, 16-20mm	Ø16mm	150mm
3127-504 *	20-50mm/0.79-1.97"	20-25mm, 25-30mm, 30-40mm, 40-50mm	Ø25mm, Ø40mm	150mm
3127-1004 *	50-100mm/1.97-3.94"	50-63mm, 62-75mm, 75-88mm, 87-100mm	Ø62mm, Ø87mm	150mm

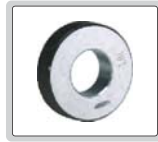
* Supplied with manufacturer inspection certificate

WIDE RANGE THREE POINTS INTERNAL MICROMETERS

- Meet DIN863-4
- Graduation 0.001mm
- Carbide measuring faces
- Ratchet stop
- Setting rings are included (except 200-300mm)



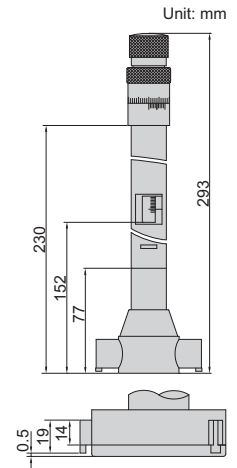
Code	Range	Accuracy	Setting ring
3228-70 *	50-70mm	5µm	Ø50mm (included)
3228-100 *	70-100mm	5µm	Ø70mm (included)
3228-150 *	100-150mm	6µm	Ø100mm (included)
3228-250 *	150-250mm	8µm	Ø150mm (included)
3228-300 *	200-300mm	9µm	Ø200mm (optional)



setting ring



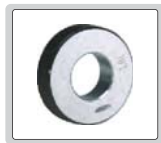
3228-70



*Supplied with manufacturer inspection certificate

DIGITAL WIDE RANGE THREE POINTS INTERNAL MICROMETERS

- Meet DIN863-4
- Resolution 0.001mm/0.00005" (resolution of 3128-300 is 0.001mm/0.0001")
- IP54 dust/waterproof
- Buttons: on/off, set, mm/inch, ABS/INC
- Data output
- LR44 battery, automatic power off
- Carbide measuring faces
- Ratchet stop
- Supplied with extension rods
- Setting rings are included (except 200-300mm)
- Optional accessory: data output cable (code 7315-30, 7302-30)



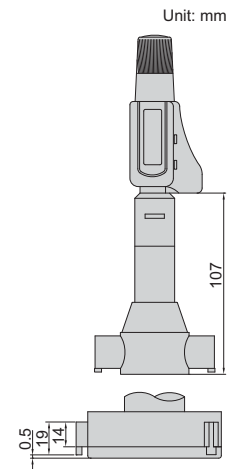
setting ring



extension rod (included)



3128-70



Code	Range	Accuracy	Setting ring	Extension rod (included)
3128-70 *	50-70mm/1.97-2.76"	5µm	Ø50mm (included)	150mm
3128-100 *	70-100mm/2.76-3.94"	5µm	Ø70mm (included)	150mm
3128-150 *	100-150mm/3.94-5.91"	6µm	Ø100mm (included)	150mm
3128-250 *	150-250mm/5.91-9.84"	8µm	Ø150mm (included)	150mm
3128-300 *	200-300mm/7.87-11.81"	9µm	Ø200mm (optional)	150mm

*Supplied with manufacturer inspection certificate

INSIDE MICROMETERS (ECONOMIC TYPE)

ATTENTION: LOW PARALLELISM OF TWO MEASURING FACES

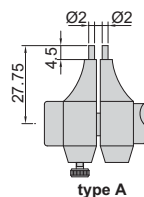
- Graduation 0.01mm
- Ratchet stop
- Carbide measuring faces
- Optional accessory: setting ring (code 6312), micrometer stand and clamp (code 6301 and 6301-1)

micrometer stand with clamp (optional)



Code	Range	Type	Setting ring	Accuracy
3220-30	5-30mm	A	5mm (included)	7µm
3220-50	25-50mm	B	25mm (included)	8µm
3220-75	50-75mm	B	50mm (optional)	9µm
3220-100	75-100mm	C	75mm (optional)	10µm

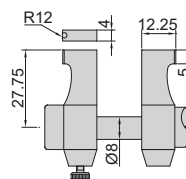
Unit: mm



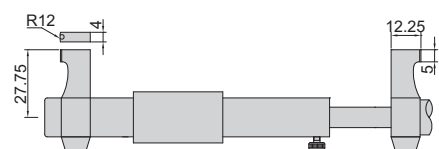
type A



3220-50



type B



type C

DATA OUTPUT

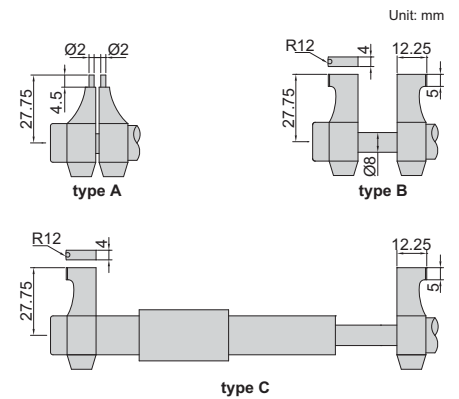
ATTENTION: LOW PARALLELISM OF TWO MEASURING FACES

DIGITAL INSIDE MICROMETERS (ECONOMIC TYPE)

- Resolution 0.001mm/0.00005"
- Button function: on/off, set, mm/inch, ABS/INC
- Data output
- LR44 battery, automatic power off
- Ratchet stop
- Carbide measuring faces
- Optional accessory: data output cable (code **7315-30**, **7302-30**), setting ring (code **6312**)



3520-30



Code	Range	Type	Setting ring	Accuracy
3520-30	5-30mm/0.2-1.2"	A	5mm (included)	±5µm
3520-50	25-50mm/1-2"	B	25mm (included)	±6µm
3520-75	50-75mm/2-3"	B	50mm (optional)	±7µm
3520-100	75-100mm/3-4"	C	75mm (optional)	±8µm

IP65 WATERPROOF

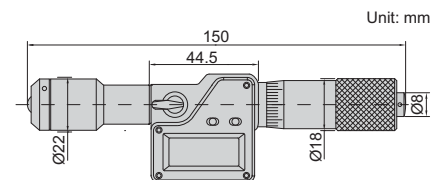
DATA OUTPUT

DIGITAL TUBULAR INSIDE MICROMETERS



3521-1000

- Micrometer head: 150-175mm
- Graduation: 0.001mm/0.00005"
- Accuracy: $(3+n+L/50)\mu\text{m}$
 n = number of rods
 L = maximum measuring length (mm)
- Carbide measuring faces
- The diameter of extension rods is 22mm
- IP65 dust/waterproof
- Button function: on/off, set, mm/inch, ABS/INC
- Data output
- LR44 battery, automatic power off
- Supplied with setting standards
- Optional accessory: data output cable (code **7315-30**, **7302-30**)



Code	Range	Travel of micrometer head	Extension rods
3521-175	150-175mm	25mm	—
3521-1000	150-1000mm	25mm	25mm, 50mm (2 pcs), 100mm, 200mm, 400mm
3521-1500	150-1500mm	25mm	25mm, 50mm (2 pcs), 100mm (2 pcs), 200mm, 400mm (2 pcs)
3521-2000	150-2000mm	25mm	25mm, 50mm (2 pcs), 100mm, 200mm (2 pcs), 400mm (3 pcs)

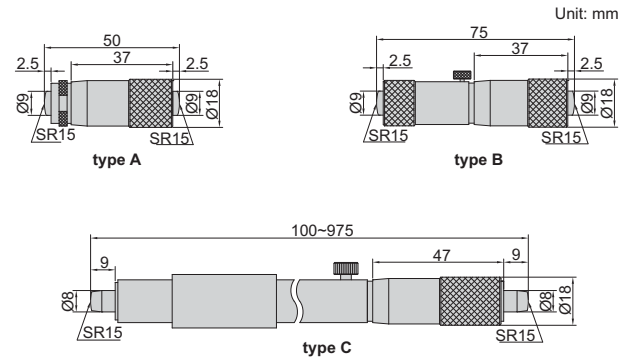
TUBULAR INSIDE MICROMETERS

- Micrometers up to 500mm meet DIN863-4
- Graduation 0.01mm
- Carbide measuring faces
- Optional accessory: gage block accessory (code **6881**), cylinder gage block (code **4001**), caliper/height gage checker (code **6884**)



3229-225

Code	Range	Type	Accuracy
3229-75	50-75mm	A	5µm
3229-100	75-100mm	B	5µm
3229-125	100-125mm	C	6µm
3229-150	125-150mm	C	6µm
3229-175	150-175mm	C	7µm
3229-200	175-200mm	C	7µm
3229-225	200-225mm	C	8µm
3229-250	225-250mm	C	8µm
3229-275	250-275mm	C	9µm
3229-300	275-300mm	C	9µm
3229-325	300-325mm	C	9µm
3229-350	325-350mm	C	9µm
3229-375	350-375mm	C	10µm
3229-400	375-400mm	C	10µm
3229-425	400-425mm	C	10µm
3229-450	425-450mm	C	10µm
3229-475	450-475mm	C	11µm
3229-500	475-500mm	C	11µm
3229-525	500-525mm	C	11µm
3229-550	525-550mm	C	11µm
3229-575	550-575mm	C	11µm
3229-600	575-600mm	C	12µm
3229-625	600-625mm	C	12µm
3229-650	625-650mm	C	12µm
3229-675	650-675mm	C	13µm
3229-700	675-700mm	C	13µm



Code	Range	Type	Accuracy
3229-725	700-725mm	C	13µm
3229-750	725-750mm	C	14µm
3229-775	750-775mm	C	14µm
3229-800	775-800mm	C	14µm
3229-825	800-825mm	C	15µm
3229-850	825-850mm	C	15µm
3229-875	850-875mm	C	15µm
3229-900	875-900mm	C	16µm
3229-925	900-925mm	C	16µm
3229-950	925-950mm	C	16µm
3229-975	950-975mm	C	17µm
3229-1000	975-1000mm	C	17µm

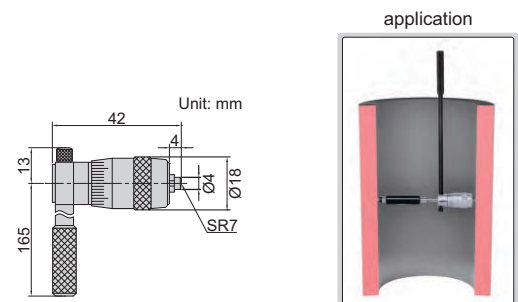
TUBULAR INSIDE MICROMETERS

- Graduation 0.01mm
- Accuracy: $(6+L/50)\mu\text{m}$
L=maximum measuring length (mm)
- Optional accessory: setting ring (code **6312**), gage block accessory (code **6881**), cylinder gage block (code **4001**), caliper/height gage checker (code **6884**)



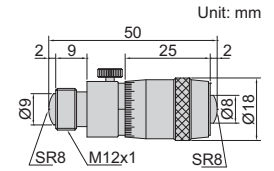
3221-200

Code	Range	Travel of micrometer head	Extension rods
3221-32	25-32mm	7mm	—
3221-50	25-50mm	7mm	2 pcs
3221-63	50-63mm	13mm	—
3221-200	50-200mm	13mm	6 pcs
3221-300	50-300mm	13mm	10 pcs
3221-225	200-225mm	25mm	—
3221-500	200-500mm	25mm	3 pcs
3221-1000	200-1000mm	25mm	8 pcs



TUBULAR INSIDE MICROMETERS

- Micrometer head: 50-63mm
- Graduation 0.01mm
- Accuracy: $(3+n+L/50)\mu\text{m}$
n=number of rods
L=maximum measuring length (mm)
- Supplied with setting standards
- Carbide measuring faces

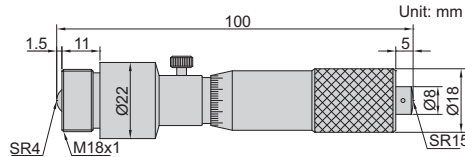


3222-150

Code	Range	Travel of micrometer head	Extension rods
3222-63	50-63mm	13mm	—
3222-150	50-150mm	13mm	13mm, 25mm, 50mm
3222-300	50-300mm	13mm	13mm, 25mm, 50mm (2 pcs), 100mm
3222-500	50-500mm	13mm	13mm, 25mm, 50mm (2 pcs), 100mm, 200mm
3222-600	50-600mm	13mm	13mm, 25mm, 50mm, 100mm, 150mm, 200mm
3222-1000	50-1000mm	13mm	13mm, 25mm, 50mm (2 pcs), 100mm, 200mm (2 pcs), 300mm
3222-1500	50-1500mm	13mm	13mm, 25mm, 50mm (2 pcs), 100mm, 200mm (3 pcs), 300mm (2 pcs)

TUBULAR INSIDE MICROMETERS

- Micrometer head: 100-125mm
- Graduation 0.01mm
- Accuracy: $(3+n+L/50)\mu\text{m}$
n=number of rods
L=maximum measuring length (mm)
- Travel of micrometer head 25mm
- Supplied with setting standards
- Carbide measuring faces



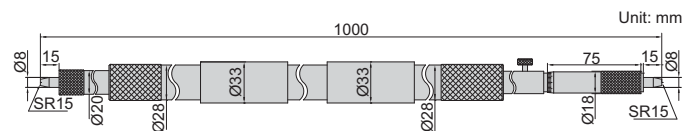
3225-500

Code	Range	Extension rods
3225-125	100-125mm	—
3225-500	100-500mm	25mm, 50mm, 100mm, 200mm
3225-900	100-900mm	25mm, 50mm, 100mm, 200mm, 400mm
3225-1300	100-1300mm	25mm, 50mm, 100mm, 200mm, 400mm (2 pcs)
3225-1700	100-1700mm	25mm, 50mm, 100mm, 200mm, 400mm (3 pcs)
3225-2100	100-2100mm	25mm, 50mm, 100mm, 200mm, 400mm (4 pcs)

TUBULAR INSIDE MICROMETERS



3224-2000



Code	Range	Extension rods
3224-2000	1000-2000mm	50mm, 100mm (2 pcs), 200mm, 500mm
3224-3000	1000-3000mm	50mm, 100mm (2 pcs), 200mm, 500mm, 1000mm
3224-4000	1000-4000mm	50mm, 100mm (2 pcs), 200mm, 500mm, 1000mm (2 pcs)
3224-5000	1000-5000mm	50mm, 100mm (2 pcs), 200mm, 500mm, 1000mm (3 pcs)

- Micrometer head: 1000-1050mm
- Graduation 0.01mm
- Accuracy: $(7+n+L/50)\mu\text{m}$
n=number of rods
L=maximum measuring length (mm)
- Travel of micrometer head 50mm
- Carbide measuring faces

DIGITAL NON-ROTATING SPINDLE TUBULAR INSIDE MICROMETERS

INSIZE PLUS
MADE IN EUROPE

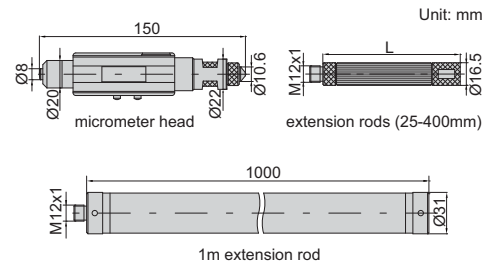
DATA
OUTPUT

SPRING LOADED
MEASURING POINT

NON-ROTATING
SPINDLE



3635-950



- Carbide measuring faces for micrometer head and extension rods
- Points of extension rods are spring loaded
- Data output
- Button function: mm/inch, max./min. value tracking, tolerance measurement, hold, on/off, zero
- CR2032 battery, automatic power off
- Optional accessory: gage block accessory (code **6881**), cylinder gage block (code **4001**), caliper/height gage checker (code **6884**)

Extension rods

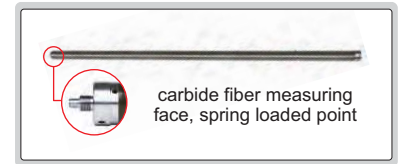
Length (L)	Accuracy	Weight	Material
25mm	±1.25µm	37g	steel
50mm	±1.25µm	65g	steel
100mm	±2µm	113g	steel
200mm	±3.5µm	208g	steel
400mm	±4.5µm	402g	steel
1000mm	±7.5µm	909g	carbon fiber

Micrometer head

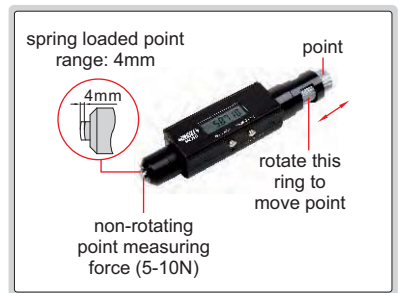
Range	Resolution	Accuracy	Repeatability	Measuring force	Weight
150-175mm	0.001mm/0.00005" 0.01mm/0.0005" (switchable)	±4µm	1µm	5-10N	275g

Code	Range	Extension rods
3635-350	150-350mm	25mm, 50mm, 100mm
3635-550	150-550mm	25mm, 50mm, 100mm, 200mm
3635-950	150-950mm	25mm, 50mm, 100mm, 200mm, 400mm
3635-1550	150-1550mm	25mm, 50mm, 100mm, 200mm (2 pcs), 400mm (2 pcs)
3635-2150	150-2150mm	25mm, 50mm, 100mm, 200mm, 400mm (4 pcs)
3635-3150	150-3150mm	25mm, 50mm, 100mm, 200mm (2 pcs), 400mm, 1000mm (2 pcs)
3635-4150	150-4150mm	25mm, 50mm, 100mm, 200mm (2 pcs), 400mm, 1000mm (3 pcs)
3635-5150	150-5150mm	25mm, 50mm, 100mm, 200mm (2 pcs), 400mm, 1000mm (4 pcs)
3635-6150	150-6150mm	25mm, 50mm, 100mm, 200mm (2 pcs), 400mm, 1000mm (5 pcs)

1m carbon fiber extension rod,
light weight, no deform



non-rotating spindle, spring loaded point
and max./min. value tracking make it
easy to find the right measuring position



TUBULAR INSIDE MICROMETERS

INSIZE PLUS
MADE IN EUROPE

- Carbide measuring faces for micrometer head and extension rods
- Points of extension rods are spring loaded
- Optional accessory:
gage block accessory (code **6881**),
cylinder gage block (code **4001**),
caliper/height gage checker (code **6884**)



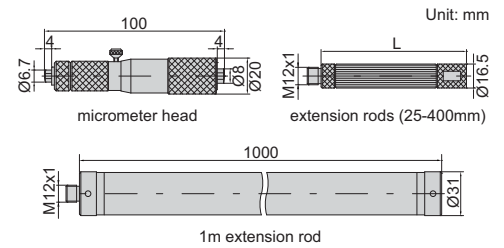
3634-1300

Micrometer head

Range	Graduation	Accuracy	Weight
100-125mm	0.01mm	±4μm	154g

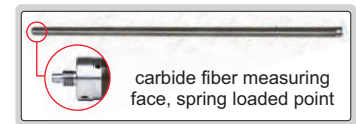
Extension rods

Length (L)	Accuracy	Weight	Material
25mm	±1.25μm	37g	steel
50mm	±1.25μm	65g	steel
100mm	±2μm	113g	steel
200mm	±3.5μm	208g	steel
400mm	±4.5μm	402g	steel
1000mm	±7.5μm	909g	carbon fiber



Code	Range	Extension rods
3634-350	100-350mm	25mm, 200mm
3634-500	100-500mm	25mm, 50mm, 100mm, 200mm
3634-1300	100-1300mm	25mm, 50mm, 100mm, 200mm, 400mm (2 pcs)
3634-1500	100-1500mm	25mm, 50mm, 100mm, 200mm (2 pcs), 400mm (2 pcs)
3634-2100	100-2100mm	25mm, 50mm, 100mm, 200mm, 400mm (4 pcs)
3634-3100	100-3100mm	25mm, 50mm, 100mm, 200mm (2 pcs), 400mm, 1000mm (2 pcs)
3634-4100	100-4100mm	25mm, 50mm, 100mm, 200mm (2 pcs), 400mm, 1000mm (3 pcs)
3634-5100	100-5100mm	25mm, 50mm, 100mm, 200mm (2 pcs), 400mm, 1000mm (4 pcs)
3634-6100	100-6100mm	25mm, 50mm, 100mm, 200mm (2 pcs), 400mm, 1000mm (5 pcs)

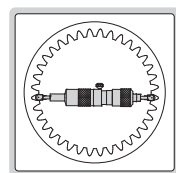
1m carbon fiber extension rod,
light weight, no deform



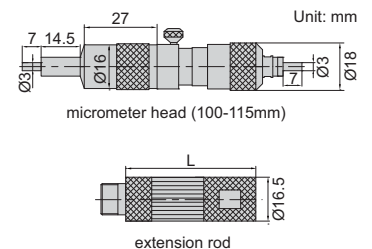
RELATIVE PRODUCT:
GEAR BORE GAGE (CODE 2428)

INTERNAL GEAR TOOTH MICROMETERS

INSIZE PLUS
MADE IN EUROPE



3638-200



- Measure over-pin diameter of gears
- Points of extension rods are spring loaded
- Optional accessory: ball tips (code **7383**)

Micrometer head

Range	Graduation	Accuracy
100-115mm	0.01mm	±4μm
150-175mm	0.01mm	±4μm

Extension rod

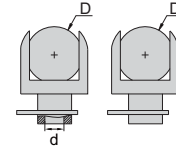
Length (L)	Accuracy
15mm	±1μm
25mm	±1.25μm
30mm	±1.25μm
50mm	±1.25μm
100mm	±2μm
200mm	±3.5μm
400mm	±4.5μm

Code	Range	Micrometer head	Extension rod (L)
3638-200	100-205mm	100-115mm	15mm, 25mm, 50mm
3638-500	100-505mm	100-115mm	15mm, 25mm, 50mm, 100mm, 200mm
3638-900	100-905mm	100-115mm	15mm, 25mm, 50mm, 100mm, 200mm, 400mm
3638-1100	150-1150mm	150-175mm	25mm, 50mm, 100mm, 200mm, 200mm, 400mm

BALL TIPS FOR GEAR TOOTH MICROMETERS

INSIZE PLUS
MADE IN EUROPE

- Supplied in pair
- Made of hardened special steel
- Suitable for 3638 series micrometers



7383-8

6

Code	Ball dia. (D)	Accuracy of D	d
7383-1	SØ1mm	±1µm	Ø3mm
7383-2	SØ2mm	±1µm	Ø3mm
7383-3	SØ3mm	±1µm	Ø3mm
7383-4	SØ4mm	±1µm	Ø3mm
7383-5	SØ5mm	±1µm	Ø3mm
7383-6	SØ6mm	±1µm	Ø3mm
7383-7	SØ7mm	±1µm	Ø3mm
7383-8	SØ8mm	±1µm	Ø3mm

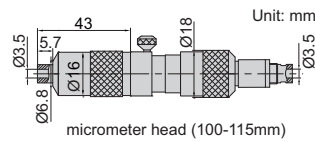
Code	Ball dia. (D)	Accuracy of D	d
7383-9	SØ9mm	±1µm	Ø3mm
7383-10	SØ10mm	±1µm	Ø3mm
7383-11	SØ11mm	±1µm	Ø3mm
7383-12	SØ12mm	±1µm	Ø3mm
7383-13	SØ13mm	±1µm	Ø3mm
7383-14	SØ14mm	±1µm	Ø3mm
7383-15	SØ15mm	±1µm	Ø3mm
7383-16	SØ16mm	±1µm	Ø3mm

INTERNAL SCREW THREAD MICROMETERS

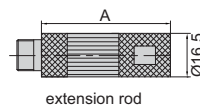
INSIZE PLUS
MADE IN EUROPE



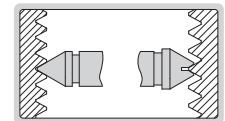
3641-200



micrometer head (100-115mm)



extension rod



tips are optional

tips are optional

- Measure pitch diameter of screw thread
- Points of extension rods are spring loaded
- Optional accessory: measuring tips for internal screw thread micrometer (code 7385, L=13.5mm)

Micrometer head

Range	Graduation	Accuracy
100-115mm	0.01mm	±4µm
150-175mm	0.01mm	±4µm

Extension rod

Length (A)	Accuracy
15mm	±1µm
25mm	±1.25µm
50mm	±1.25µm
100mm	±2µm
200mm	±3.5µm
400mm	±4.5µm

Code	Range	Micrometer head	Extension rod (A)	Applicable tips
3641-200	100-205mm	100-115mm	15mm, 25mm, 50mm	stem length L=13.5mm
3641-500	100-505mm	100-115mm	15mm, 25mm, 50mm, 100mm, 200mm	stem length L=13.5mm
3641-900	100-905mm	100-115mm	15mm, 25mm, 50mm, 100mm, 200mm, 400mm	stem length L=13.5mm
3641-1100	150-1150mm	150-175mm	25mm, 50mm, 100mm, 200mm, 400mm	stem length L=13.5mm

TIPS FOR TRAPEZOIDAL, ACME
THREAD ARE ALSO AVAILABLE

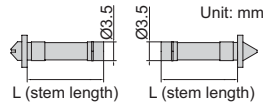
MEASURING TIPS FOR INTERNAL SCREW THREAD MICROMETERS

INSIZE PLUS
MADE IN EUROPE

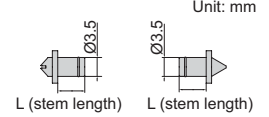
- Supplied in pair
- Made of hardened steel
- Suitable for **3641** series micrometers



7385-T106A



7385-T106B



60° thread angle

Code		Applicable pitch (mm)
L=13.5mm	L=5mm	
7385-T101A	7385-T101B	0.35
7385-T102A	7385-T102B	0.4/0.45
7385-T103A	7385-T103B	0.5/0.6
7385-T104A	7385-T104B	0.7/0.75/0.8
7385-T105A	7385-T105B	1/1.25
7385-T106A	7385-T106B	1.5/1.75
7385-T107A	7385-T107B	2.0/2.5
7385-T108A	7385-T108B	3.0/3.5
7385-T109A	7385-T109B	4.0/4.5/5.0
7385-T110A	7385-T110B	5.5/6.0

55° thread angle

Code		Applicable pitch (TPI)
L=13.5mm	L=5mm	
7385-T201A	7385-T201B	60/48
7385-T202A	7385-T202B	40/32
7385-T203A	7385-T203B	28/26/24/22
7385-T204A	7385-T204B	20/19/18/16
7385-T205A	7385-T205B	14/12/11
7385-T206A	7385-T206B	10/9/8
7385-T207A	7385-T207B	7/6
7385-T208A	7385-T208B	5/4.5/4
7385-T209A	7385-T209B	3.5/3.25/3/2.875/2.75
7385-T210A	7385-T210B	2.625/2.5/2

INTERNAL SCREW THREAD MICROMETERS

- Graduation: 0.01mm
- Optional accessory: measuring tips for internal screw thread micrometer (code 7321)



measuring tips for screw thread (optional)

measuring tips for screw thread (optional)

3226-1001

measuring tips for internal screw thread micrometer (optional)



Code	Range	Code	Range
3226-1001	75-100mm	3226-2251	200-225mm
3226-1251	100-125mm	3226-2501	225-250mm
3226-1501	125-150mm	3226-2751	250-275mm
3226-1751	150-175mm	3226-3001	275-300mm
3226-2001	175-200mm		

MEASURING TIPS FOR INTERNAL SCREW THREAD MICROMETERS

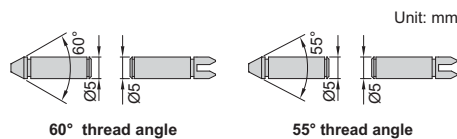
- Supplied in pair
- Suitable for **3226** series micrometers

Metric and unified screw (60° thread angle)

Code	Pitch
7321-T11	0.4-0.5mm/64-48TPI
7321-T12	0.6-0.9mm/44-28TPI
7321-T13	1-1.75mm/24-14TPI
7321-T14	2-3mm/13-9TPI
7321-T15	3.5-5mm/8-5TPI
7321-T16	5.5-7mm/4.5-3.5TPI
7321-T1S	6 pairs/set, including all above tips



7321-T1S



60° thread angle

55° thread angle

Whitworth screw (55° thread angle)

Code	Pitch
7321-T21	60-48TPI
7321-T22	48-40TPI
7321-T23	40-32TPI
7321-T24	32-24TPI
7321-T25	24-18TPI
7321-T26	18-14TPI
7321-T27	14-10TPI
7321-T28	10-7TPI
7321-T29	7-4.5TPI
7321-T210	4.5-3.5TPI
7321-T2S	10 pairs/set, including all above tips

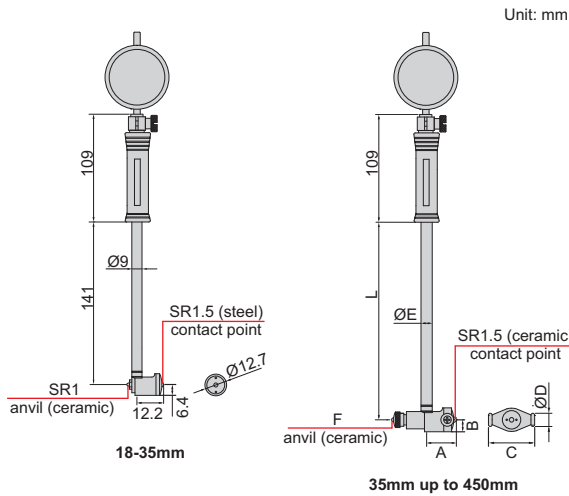
BORE GAGES

ATTENTION: NOT SUITABLE FOR 0.001MM DIAL INDICATORS

DATA OUTPUT



6

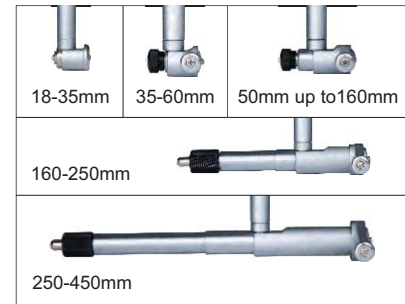


- Optional accessory: setting ring (code **6312**), long handle (code **7351**), bore gage setter

Range	A	B	C	ØD	ØE	F	L
35-60mm	22	9	27	13	12.8	SR2	141
50-100mm	26	9	35	13	12.8	SR2	141
50-160mm	26	9	35	13	12.8	SR2	141
100-160mm	26	9	35	13	12.8	SR2	141
160-250mm	56.5	13	74.5	15	12.8	SR2	241
250-450mm	86.5	15	101.5	15	14.5	SR2.5	241

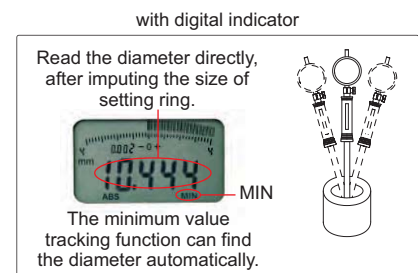
With dial indicator

Code	Range	Indicator	Accuracy	Repeatability
2322-35A	18-35mm	dial indicator, range 10mm, graduation 0.01mm (code 2308-10FA)	±0.015mm	0.003mm
2322-60A	35-60mm		±0.018mm	0.003mm
2322-100A	50-100mm		±0.018mm	0.003mm
2322-160A	50-160mm		±0.018mm	0.003mm
2322-161A	100-160mm		±0.018mm	0.003mm
2322-250A	160-250mm		±0.018mm	0.003mm
2322-450A	250-450mm		±0.018mm	0.003mm



With digital indicator

Code	Range	Indicator	Accuracy	Repeatability
2122-35A	18-35mm	digital indicator, code 2108-10F , range 12.7mm/0.5", resolution 0.002mm/0.0001" (can switch to: 0.01mm/0.0005")	±0.015mm	0.003mm
2122-60A	35-60mm		±0.018mm	0.003mm
2122-100A	50-100mm		±0.018mm	0.003mm
2122-160A	50-160mm		±0.018mm	0.003mm
2122-161A	100-160mm		±0.018mm	0.003mm
2122-250A	160-250mm		±0.018mm	0.003mm
2122-450A	250-450mm		±0.018mm	0.003mm



ATTENTION: NOT SUITABLE FOR 0.001MM DIAL INDICATORS

BORE GAGES FOR SMALL HOLES

with digital indicator

Read the diameter directly, after inputting the size of setting ring.

The minimum value tracking function can find the diameter automatically.

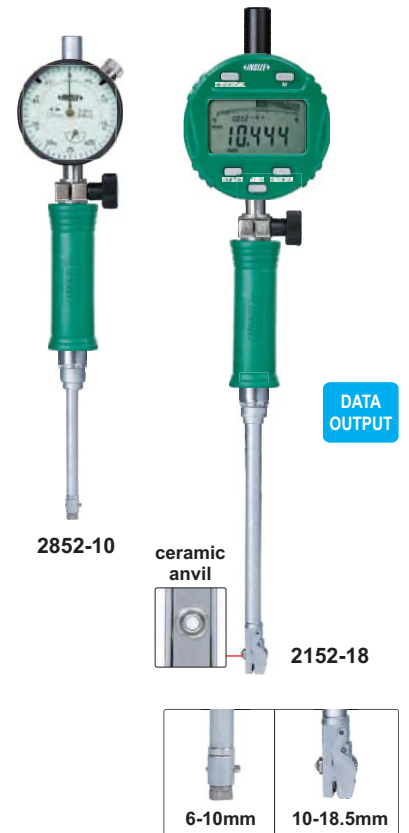
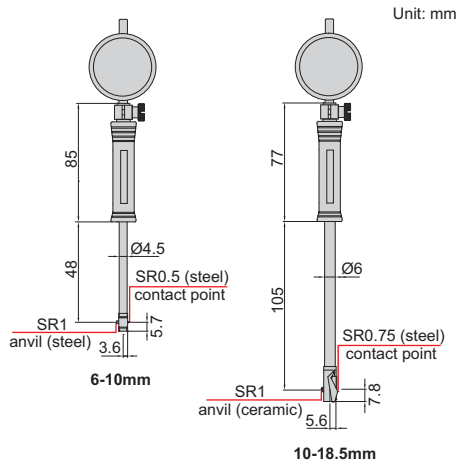
- Optional accessory: setting ring (code **6312**), bore gage setter

With dial indicator

Code	Range	Indicator	Accuracy	Repeatability
2852-10	6-10mm	dial indicator, range 3mm, graduation 0.01mm (code 2311-3F)	±0.012mm	0.003mm
2852-18	10-18.5mm		±0.012mm	0.003mm

With digital indicator

Code	Range	Indicator	Accuracy	Repeatability
2152-10	6-10mm	digital indicator, code 2108-10F , range 12.7mm/0.5", resolution 0.002mm/0.0001" (can switch to: 0.01mm/0.0005")	±0.012mm	0.003mm
2152-18	10-18.5mm		±0.012mm	0.003mm



ATTENTION: NOT SUITABLE FOR 0.001MM DIAL INDICATORS

BORE GAGES

with digital indicator

Read the diameter directly, after inputting the size of setting ring.

The minimum value tracking function can find the diameter automatically.

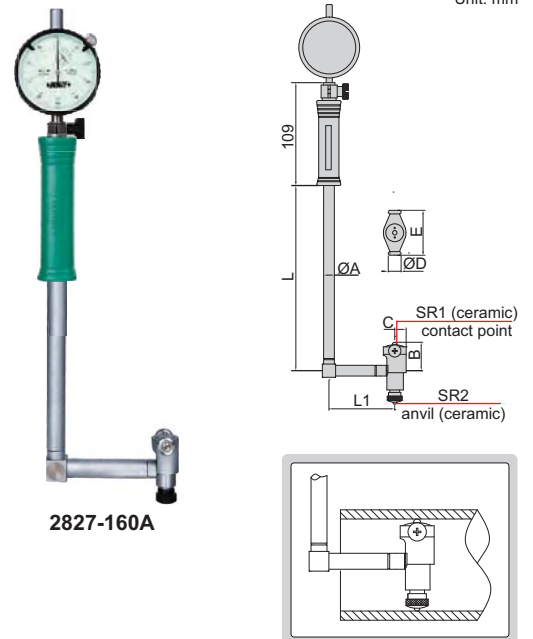
- Optional accessory: setting ring (code **6312**), long handle (code **7351**), bore gage setter

With dial indicator

Code	Range	Indicator	Accuracy	Repeatability
2827-60A	35-60mm	dial indicator code 2308-10FA , range 10mm, graduation 0.01mm	±0.018mm	0.003mm
2827-160A	50-160mm		±0.018mm	0.003mm
2827-250A	160-250mm		±0.018mm	0.003mm
2827-450A	250-450mm		±0.018mm	0.003mm

With digital indicator

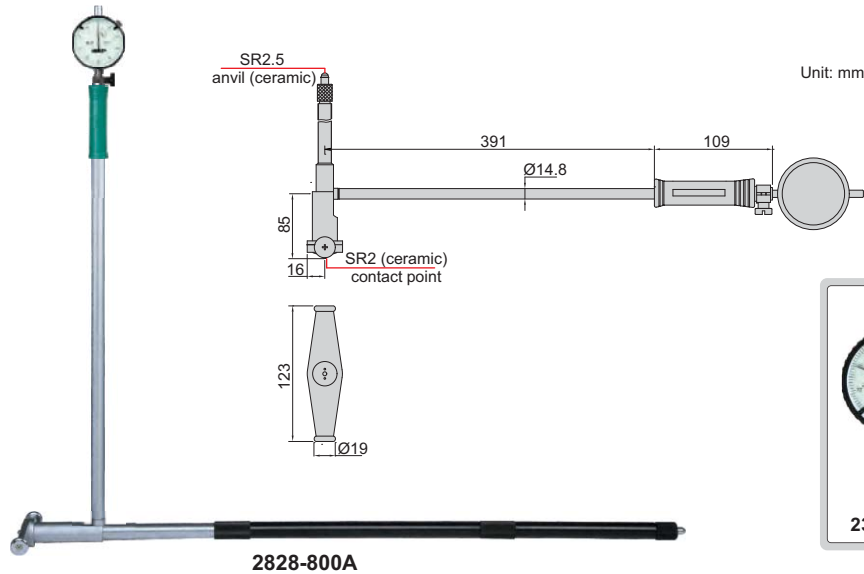
Code	Range	Indicator	Accuracy	Repeatability
2127-60	35-60mm	digital indicator, code 2108-10F , range 12.7mm/0.5", resolution 0.002mm/0.0001" (can switch to: 0.01mm/0.0005")	±0.018mm	0.003mm
2127-160	50-160mm		±0.018mm	0.003mm
2127-250	160-250mm		±0.018mm	0.003mm
2127-450	250-450mm		±0.018mm	0.003mm



Range	ØA	B	C	ØD	E	L	L1
35-60mm	12.8	22	9	13	27	141	75
50-160mm	12.8	28.5	9.2	13	35	141	76.2
160-250mm	14.5	62.0	12.7	15	74.5	391	100
250-450mm	14.5	91.5	15.0	15	101.5	391	100

BORE GAGES

ATTENTION: NOT SUITABLE FOR 0.001MM DIAL INDICATORS



Unit: mm



6

Code	Range	Indicator	Accuracy	Repeatability
2828-800A	400-800mm	dial indicator, code 2308-10FA , range 10mm, graduation 0.01mm	±0.025mm	0.003mm
2128-800A	400-800mm	digital indicator, code 2108-10F , range 12.7mm/0.5", resolution 0.002mm/0.0001" (can switch to: 0.01mm/0.0005")	±0.025mm	0.003mm

BORE GAGE SETS

packaging (code **2824-S3**)



- Optional accessory: setting ring (code **6312**), long handle (code **7351**), bore gage setter



ATTENTION: NOT SUITABLE FOR 0.001MM DIAL INDICATORS

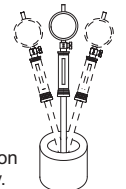


with digital indicator

Read the diameter directly, after inputting the size of setting ring.



The minimum value tracking function can find the diameter automatically.



With dial indicator

Code	Range	Indicator	Bore gages included	Accuracy	Repeatability
2824-S160	35-160mm	dial indicator, code 2308-10FA , range 10mm, graduation 0.01mm	① 35-50mm (dial indicator and handle are not included) ② 50-160mm	35-50mm ±0.018mm 50-160mm ±0.018mm	0.003mm
2824-S3	18-160mm	dial indicator, code 2308-10FA , range 10mm, graduation 0.01mm	① 18-35mm ② 35-60mm (dial indicator is not included) ③ 50-160mm (dial indicator is not included)	18-35mm ±0.015mm 35-60mm ±0.018mm 50-160mm ±0.018mm	0.003mm

With digital indicator

Code	Range	Indicator	Bore gages included	Accuracy	Repeatability
2724-S160	35-160mm	digital indicator, code 2108-10F range 12.7mm/0.5", resolution 0.002mm/0.0001" (can switch to: 0.01mm/0.0005")	① 35-50mm (digital indicator and handle are not included) ② 50-160mm	35-50mm ±0.018mm 50-160mm ±0.018mm	0.003mm
2724-S3	18-160mm	digital indicator, code 2108-10F range 12.7mm/0.5", resolution 0.002mm/0.0001" (can switch to: 0.01mm/0.0005")	① 18-35mm ② 35-60mm (digital indicator is not included) ③ 50-160mm (digital indicator is not included)	18-35mm ±0.015mm 35-60mm ±0.018mm 50-160mm ±0.018mm	0.003mm

ATTENTION: NOT SUITABLE FOR 0.001MM DIAL INDICATORS

MEASURE DIAMETER OF BORES WITH BARRIER INSIDE

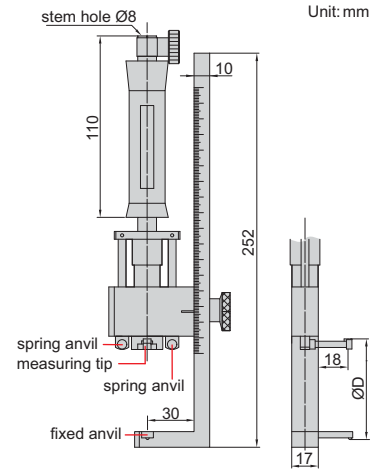


BORE GAGE FOR BARRIER INSIDE BORE

dial indicator is optional



application



2348-210

- Measure diameter of bores with barrier inside
- Optional accessory:
 - 0.01mm graduation dial indicators
 - Setting ring (code 6312)

Code	Range ØD	Diameter of barrier Ød	Travel of measuring tip	Accuracy (without dial indicator)	Measuring force
2348-210*	40-210mm	<D-14 (less than 50mm)*	1.6mm	0.018mm	2N

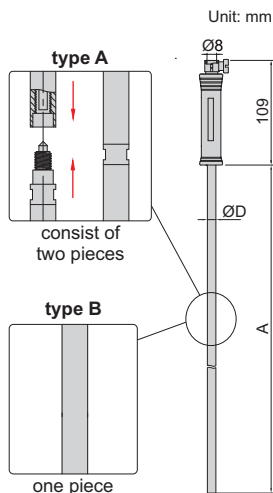
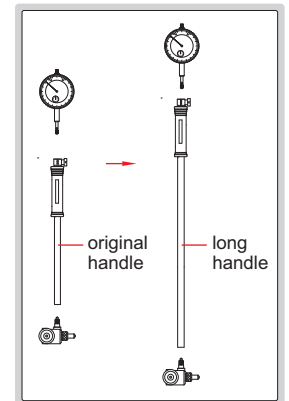
* For example:

When measuring size ØD is 40mm, D-14=26mm, so the diameter of barrier should be less than 26mm.

When measuring size ØD is 70mm, D-14=56mm, however it should be less than 50mm, so the diameter of barrier should be less than 50mm.

LONG HANDLES

method of use (replace the original handle with long handle)



7351-EX11

- To assist deep-hole measurement
- Can be used for bore gages 2122, 2127, 2322, 2724, 2824 and 2827

Code	Applicable bore gages	A	ØD	Type
7351-EX11	35-60mm, 50-100mm, 50-160mm, 100-160mm	475mm	13mm	B
7351-EX12		980mm	13mm	
7351-EX13		1480mm	14.5mm	A
7351-EX14		1980mm	14.5mm	
7351-EX21	160-250mm, 250-450mm	480mm	14.5mm	B
7351-EX22		980mm	14.5mm	
7351-EX23		1480mm	14.5mm	A
7351-EX24		1980mm	14.5mm	

ANVILS FOR BORE GAGES

- For bore gages 2852, 2152, 2322, 2122, 2127, 2724, 2824 and 2827

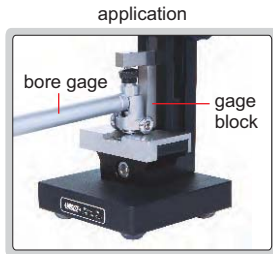


7350-160

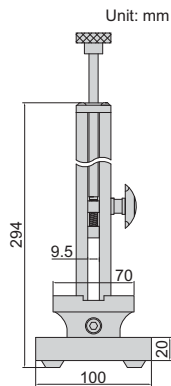
Code	Applicable bore gages	Material of measuring face	Quantity per set	Measuring range of anvil (mm)
7350-10	6-10mm	steel	9 pcs	6, 6.5, 7, 7.5, 8, 8.5, 9, 9.5, 10
7350-18	10-18.5mm	ceramic	9 pcs	10, 11, 12, 13, 14, 15, 16, 17, 18
7350-35	18-35mm	ceramic	9 pcs	18, 20, 22, 24, 26, 28, 30, 32, 34
7350-60	35-60mm	ceramic	6 pcs	35, 40, 45, 50, 55, 60
7350-100	50-100mm	ceramic	11 pcs	50, 55, 60, 65, 70, 75, 80, 85, 90, 95, 100
7350-160	50-160mm	ceramic	12 pcs	50, 55, 60, 65, 70, 75, 80, 85, 90, 95, 100, 105
7350-161	100-160mm	ceramic	12 pcs	50, 55, 60, 65, 70, 75, 80, 85, 90, 95, 100, 105
7350-250	160-250mm	ceramic	5 pcs	160, 170, 180, 190, 200
7350-450	250-450mm	ceramic	5 pcs	250, 260, 270, 280, 290

6

BORE GAGE SETTERS



- Vertical and horizontal use
- To be used with gage blocks



7353-160

horizontal use



gage blocks for 7353-160



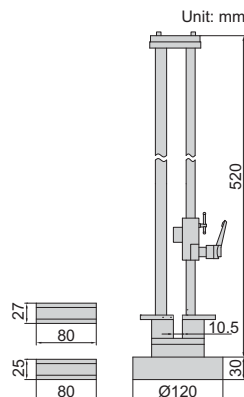
Gage block set for 7353-160

Blocks per set	Size (mm)	Step (mm)	Quantity	Remark
33	1.005		1 pc	grade 2 (ISO3650)
	1.01-1.09	0.01	9 pcs	
	1.1-1.9	0.1	9 pcs	
	1-9	1	9 pcs	
	10-30	10	3 pcs	
	50		1 pc	
	100		1 pc	

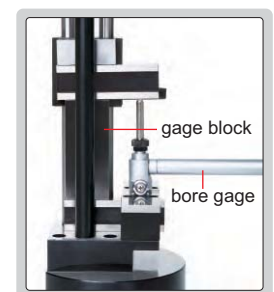
BORE GAGE SETTER



- Used together with gage blocks to set bore gages



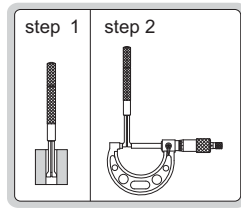
2395-400



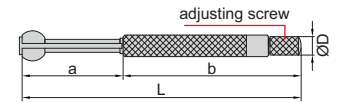
Code	Setting range
2395-400	18-400mm

SMALL HOLE GAGE SET

- 4 gages per set
- For small holes, slots and grooves, etc.
- Satin chrome finish



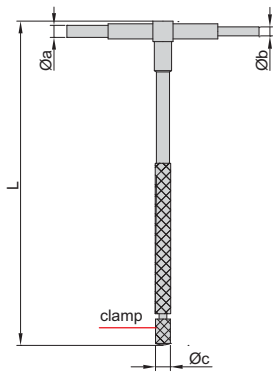
4208-1



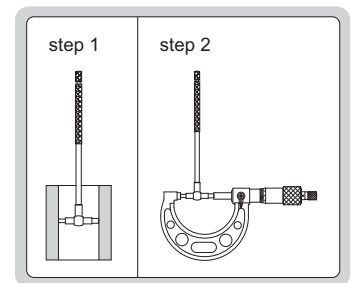
Range	L	a	b	ØD
3-5mm	76	24	52	5
5-7.5mm	79	27	52	5
7.5-10mm	88	30	58	6
10-13mm	91	34	58	6

Code	Total range	Gages included
4208-1	3-13mm	3-5mm, 5-7.5mm, 7.5-10mm, 10-13mm

TELESCOPING GAGE SET



4206-1



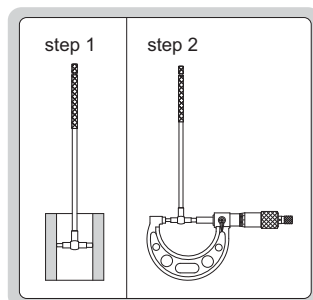
- 6 gages per set
- For quick measurement of inside diameter of holes and width of slots
- Satin chrome finish

Range	L	Øa	Øb	Øc
8-12.7mm	115	3.9	2.9	6.2
12.7-19mm	115	5.3	3.8	6.2
19-32mm	115	5.3	3.8	6.2
32-54mm	137	7.6	6.1	7.2
54-90mm	137	7.6	6.1	7.2
90-150mm	137	7.6	6.1	7.2

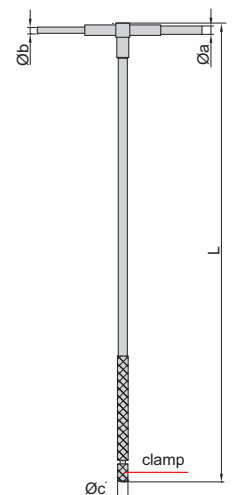
Code	Total range	Gages included
4206-1	8-150mm	8-12.7mm, 12.7-19mm, 19-32mm, 32-54mm, 54-90mm, 90-150mm

LONG HANDLE TELESCOPING GAGES

- For quick measurement of inside diameter of deep holes and width of slots
- Satin chrome finish



4209-6

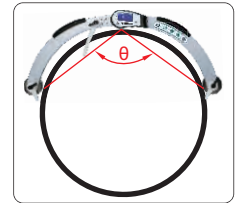


Code	Range	L	Øa	Øb	Øc
4209-1	8-12.7mm	300mm	3.9mm	2.9mm	6.2mm
4209-2	12.7-19mm	300mm	5.3mm	3.8mm	6.2mm
4209-3	19-32mm	300mm	5.3mm	3.8mm	6.2mm
4209-4	32-54mm	300mm	7.6mm	6.1mm	7.2mm
4209-5	54-90mm	300mm	7.6mm	6.1mm	7.2mm
4209-6	90-150mm	300mm	7.6mm	6.1mm	7.2mm

LARGE DIAMETER GAGE CODE ISQ-RA600

INSIZE PLUS
MADE IN EUROPE

DATA
OUTPUT



software CD
(included)

- To measure large external or internal diameters
- Automatic judgment and display external or internal diameter
- Backlight LCD display, can rotate 180° for easy reading
- Memory of 12 readings and average calculation
- With minimum and maximum measurement mode
- Angle can be displayed

SPECIFICATION

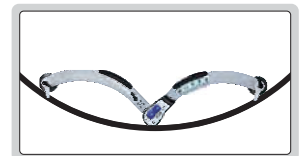
Range	external	Ø500~6000mm/19.69~236.22"
	internal	Ø1100~6000mm/43.31~236.22"
Resolution	0.01mm/0.001"	
Accuracy	±(0.01+D²/30)mm (D is the diameter to be measured, in meter)	
Power supply	rechargeable battery (for 8 hours working)	
Weight	3.8kg	

STANDARD DELIVERY

Main unit	1 pc
AC/DC adapter	1 pc
Software and USB cable	1 pc



external diameter measurement



internal diameter measurement



software (included),
data output, save and print

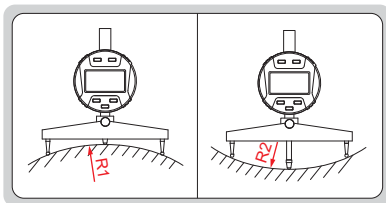
Accuracy sample by diameters

Diameter	Accuracy
500mm	±0.018mm
1000mm	±0.043mm
1500mm	±0.085mm
2000mm	±0.143mm
2500mm	±0.218mm
3000mm	±0.310mm
4000mm	±0.543mm
5000mm	±0.843mm
6000mm	±1.210mm

DIGITAL RADIUS GAGE



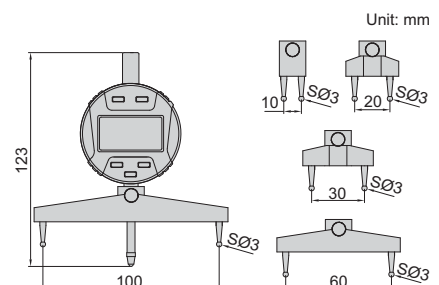
ATTENTION: NO
DATA OUTPUT



2183

- Resolution: 0.005mm/0.0002"
- Buttons: on/off, hold, mm/inch, s (select jaws), zero
- Measure radius of internal or external arcs
- Display can be rotated by 320°
- Supplied with 5 jaws for different sizes of arc
- Battery CR2032, automatic power off

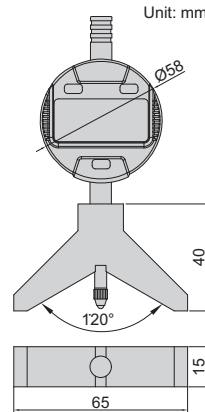
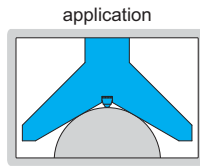
Code	Range of external radius (R1)	Range of internal radius (R2)	Accuracy (mm)
2183	5-910mm/0.2-35.83"	7-910mm/0.3-35.83"	±0.01R*



* R is the radius to be measured. For example, radius is 100mm, the accuracy is ±0.01x100=±1mm

DIGITAL RADIUS GAGE

- Measure radius of external arc, arc angle of measured surface should be larger than 60°
- Display radius value, no need to calculate
- Button function: on/off, zero, data preset, inch/mm
- Keep preset data in memory after restart
- CR2032 battery, automatic power off
- Data output
- Stainless steel base
- Supplied with pin gage for zero setting
- Optional accessory: data output cable (code 7315-50M, 7302-40M)

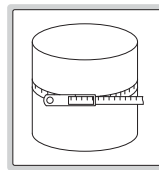


Code	Range (radius)	Resolution	Accuracy
2188-55	4-53mm/0.16-2.09"	0.01mm/0.0005"	±0.02mm

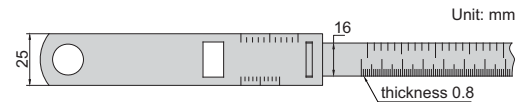
6
7

CIRCUMFERENCE TAPES

- Measure diameter and circumference of soft materials like pipes, trees, tires, etc.
- Graduation: 0.1mm
- Laser engraved scale
- Made of stainless steel



7114-950



Code	Circumference range	Diameter range	Accuracy	
			Circumference	Diameter
7114-950	150-950mm	Ø50-300mm	±3mm	±1mm
7114-2200	940-2200mm	Ø300-700mm	±3mm	±1mm
7114-3460	2190-3460mm	Ø700-1100mm	±3mm	±1mm

ATTENTION: RECHARGEABLE BATTERY, FOR 24 HOURS CONTINUOUS WORKING

ABSOLUTE ENCODER, THE ORIGINAL DATA REMAINS AFTER POWER OFF

HIGH PRECISION DIGITAL INDICATORS

- Linear ball bearings for ten million times use
- Ø28mm stem suitable for reinforced clamping
- Absolute encoder, the original data remains after power off
- Adjustable resolution: 0.0002mm/0.00001"
0.001mm/0.00005"
0.01mm/0.0005"
- Reading in digital and analog
- Button function: data output, tolerance, data preset, data hold, measuring direction change, max./min./TIR, power off time, on/off, mm/inch, adjust resolution
- Power: rechargeable battery, for 24 hours continuous working
- Ruby probe

With data interface

Optional accessory:
wireless transmitter, code 7315-60, wireless receiver, code 7315-2, 7315-3
data output cable (keyboard format), code 7302-60
data output cable (serial port format), code 7305-G60
(cable length 3m, optional cable length maximum 15m; RS232 protocol, optional RS485 protocol)

Code	Range	Accuracy	Hysteresis	Remark
2140-6	0-6mm/0-0.24"	1.6µm	0.8µm	flat back

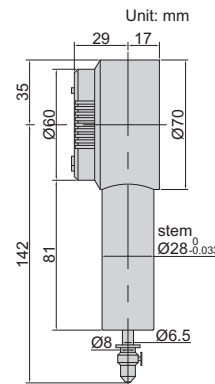
Built-in wireless

Optional accessory:
wireless receiver (keyboard format), code 2134-R1
wireless receiver (serial port format), code 2134-R2

Code	Range	Accuracy	Hysteresis	Remark
2140-6WL	0-6mm/0-0.24"	1.6µm	0.8µm	flat back



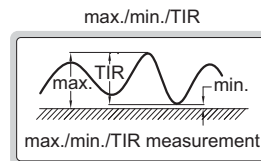
2140-6



LINEAR BALL BEARINGS FOR TEN MILLION TIMES USE

Ø28MM STEM SUITABLE FOR REINFORCED CLAMPING

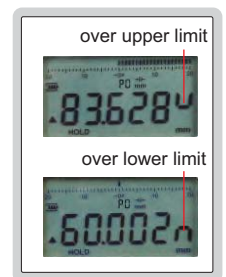
DATA OUTPUT



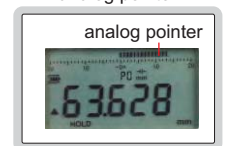
wireless receiver
2134-R1, 2134-R2 (optional)



warning when over tolerance



analog pointer



HIGH PRECISION DIGITAL INDICATORS

LINEAR BALL BEARINGS
FOR TEN MILLION TIMES USE

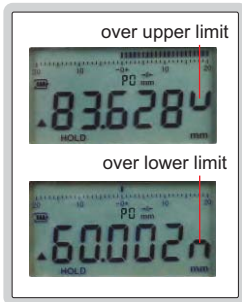
ABSOLUTE ENCODER, THE ORIGINAL
DATA REMAINS AFTER POWER OFF

DATA
OUTPUT

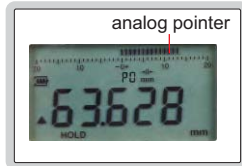
ATTENTION: RECHARGEABLE BATTERY,
FOR 24 HOURS CONTINUOUS WORKING

**INSPECTION
CERTIFICATE**
TRACEABLE TO NIST

warning when
over tolerance



analog pointer



2133-10

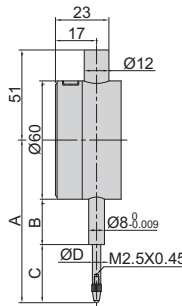


2133-25

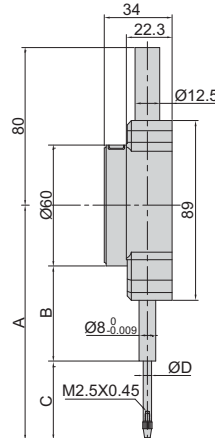


2133-50

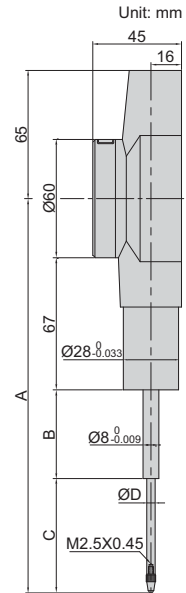
- Linear ball bearings for ten million times use
- Absolute encoder, the original data remains after power off
- Reading in digital and analog
- Data output
- Button function: data output, tolerance, data preset, data hold, measuring direction change, max./min./TIR, power off time, on/off, mm/inch, adjust resolution
- Power: rechargeable battery, for 24 hours continuous working
- Optional accessory: contact points (page 146~148), wireless transmitter, code **7315-60**, data output cable (keyboard format), code **7302-60**, data output cable (serial port format), code **7305-G60**, (cable length 3m, optional cable length maximum 15m; RS232 protocol, optional RS485 protocol)



2133-10
2133-101



2133-25
2133-251



2133-50

Low precision

Carbide probe

Adjustable resolution: 0.0005mm/0.00002"
0.001mm/0.00005"
0.01mm/0.0005"

Code	Range	Accuracy	Hysteresis	A	B	C	ØD	Remark
2133-10*	12.7mm/0.5"	3µm	1.5µm	75.4mm	20.6mm	24.8mm	5mm	flat back
2133-25*	25.4mm/1"	3µm	1.5µm	109.5mm	38.5mm	41mm	5mm	flat back
2133-50*	50.8mm/2"	3µm	1.5µm	201mm	32mm	72mm	4.5mm	flat back

High precision

Ruby probe

Adjustable resolution: 0.0002mm/0.00001"
0.001mm/0.00005"
0.01mm/0.0005"

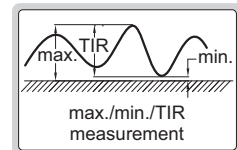
Code	Range	Accuracy	Hysteresis	A	B	C	ØD	Remark
2133-101*	12.7mm/0.5"	1.5µm	1µm	77.4mm	26mm	21.4mm	4mm	flat back
2133-251*	25.4mm/1"	1.8µm	1µm	116.1mm	42.5mm	44mm	4mm	flat back

*Supplied with manufacturer inspection certificate traceable to NIST USA

spindle lift knob is included



max./min./TIR



ATTENTION: RECHARGEABLE BATTERY,
FOR 24 HOURS CONTINUOUS WORKING

LINEAR BALL BEARINGS
FOR TEN MILLION TIMES USE

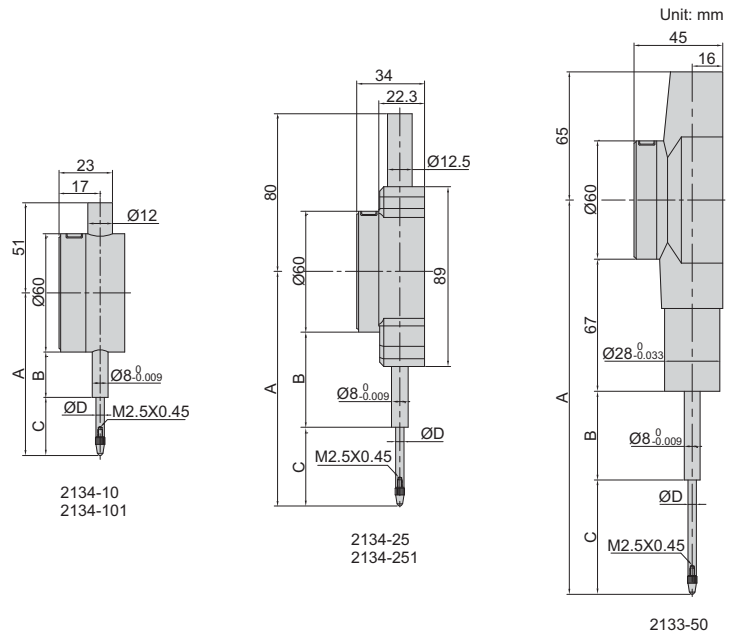
ABSOLUTE ENCODER, THE ORIGINAL
DATA REMAINS AFTER POWER OFF

**INSPECTION
CERTIFICATE**
TRACEABLE TO NIST

WIRELESS HIGH PRECISION DIGITAL INDICATORS



- Built-in wireless transmission, ZigBee signal
- Linear ball bearings for ten million times use
- Absolute encoder, the original data remains after power off
- Reading in digital and analog
- Button function: data output, tolerance, data preset, data hold, measuring direction change, max./min./TIR, power off time, on/off, mm/inch, adjust resolution
- Power: rechargeable battery, for 24 hours continuous working
- Optional accessory: contact points (page 146~148), wireless receiver, code: **2134-R1** (keyboard format), **2134-R2** (serial port format)



Low precision

Carbide probe

Adjustable resolution: 0.0005mm/0.00002"
0.001mm/0.00005"
0.01mm/0.0005"

Code	Range	Accuracy	Hysteresis	A	B	C	ØD	Remark
2134-10*	12.7mm/0.5"	3µm	1.5µm	75.4mm	20.6mm	24.8mm	5mm	flat back
2134-25*	25.4mm/1"	3µm	1.5µm	109.5mm	38.5mm	41mm	5mm	flat back
2134-50*	50.8mm/2"	3µm	1.5µm	201mm	32mm	72mm	4.5mm	flat back

High precision

Ruby probe

Adjustable resolution: 0.0002mm/0.00001"
0.001mm/0.00005"
0.01mm/0.0005"

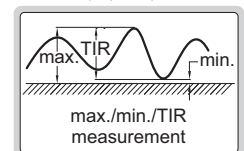
Code	Range	Accuracy	Hysteresis	A	B	C	ØD	Remark
2134-101*	12.7mm/0.5"	1.5µm	1µm	77.4mm	26mm	21.4mm	4mm	flat back
2134-251*	25.4mm/1"	1.8µm	1µm	116.1mm	42.5mm	44mm	4mm	flat back

*Supplied with manufacturer inspection certificate traceable to NIST USA

spindle lift knob is included



max./min./TIR

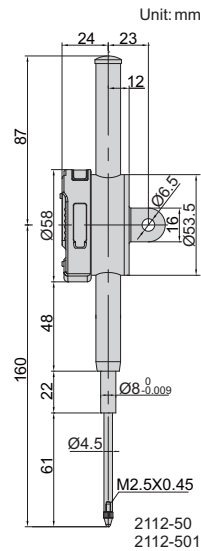
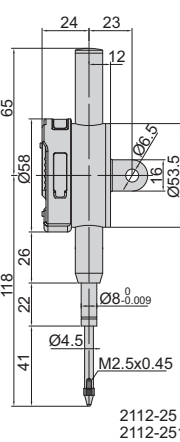
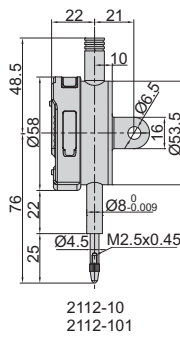


DIGITAL INDICATORS (STANDARD TYPE)

INSPECTION CERTIFICATE
TRACEABLE TO NIST

DATA OUTPUT

spindle lift knob is included



- Button function: on/off, inch/mm, zero, data preset, change measuring direction, absolute/incremental measurement
- Keep preset data in memory after restart
- CR2032 battery, automatic power off
- Data output
- Optional accessory: data output cable (code **7315-50M**, **7302-40M**, **7305-40M**), backs (page 149~150), contact points (page 146~148)

Resolution 0.001mm/0.00005"

Code	Range	Accuracy	Hysteresis	Remark
2112-101F*	12.7mm/0.5"	5µm	2µm	flat back
2112-251F*	25.4mm/1"	5µm	3µm	flat back
2112-501F*	50.8mm/2"	6µm	3µm	flat back
2112-101*	12.7mm/0.5"	5µm	2µm	lug back
2112-251*	25.4mm/1"	5µm	3µm	lug back
2112-501*	50.8mm/2"	6µm	3µm	lug back

Resolution 0.01mm/0.0005"

Code	Range	Accuracy	Hysteresis	Remark
2112-10F*	12.7mm/0.5"	20µm	10µm	flat back
2112-25F*	25.4mm/1"	20µm	10µm	flat back
2112-50F*	50.8mm/2"	30µm	10µm	flat back
2112-10*	12.7mm/0.5"	20µm	10µm	lug back
2112-25*	25.4mm/1"	20µm	10µm	lug back
2112-50*	50.8mm/2"	30µm	10µm	lug back

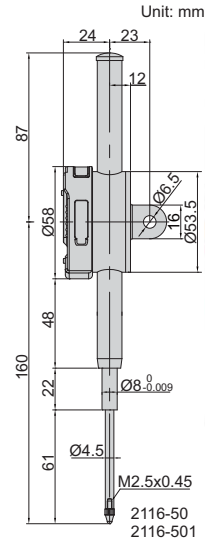
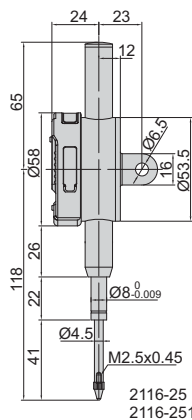
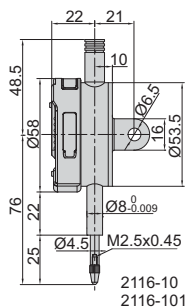
*Supplied with manufacturer inspection certificate traceable to NIST USA

METRIC DIGITAL INDICATORS

INSPECTION CERTIFICATE
TRACEABLE TO NIST

DATA OUTPUT

spindle lift knob is included



- Button function: on/off, zero, change measuring direction, data preset, absolute/incremental measurement
- Keep preset data in memory after restart
- CR2032 battery, automatic power off, data output
- Optional accessory: data output cable (code **7315-50M**, **7302-40M**, **7305-40M**), backs (page 149~150), contact points (page 146~148)

Resolution 0.001mm

Code	Range	Accuracy	Hysteresis	Remark
2116-101F*	12.7mm	5µm	2µm	flat back
2116-251F*	25.4mm	5µm	3µm	flat back
2116-501F*	50.8mm	6µm	3µm	flat back
2116-101*	12.7mm	5µm	2µm	lug back
2116-251*	25.4mm	5µm	3µm	lug back
2116-501*	50.8mm	6µm	3µm	lug back

Resolution 0.01mm

Code	Range	Accuracy	Hysteresis	Remark
2116-10F*	12.7mm	20µm	10µm	flat back
2116-25F*	25.4mm	20µm	10µm	flat back
2116-50F*	50.8mm	30µm	10µm	flat back
2116-10*	12.7mm	20µm	10µm	lug back
2116-25*	25.4mm	20µm	10µm	lug back
2116-50*	50.8mm	30µm	10µm	lug back

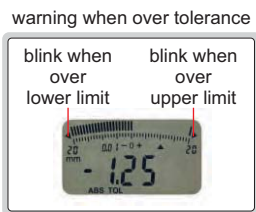
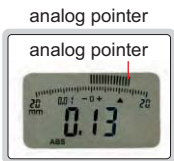
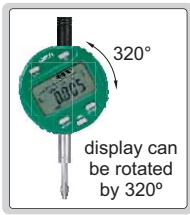
*Supplied with manufacturer inspection certificate traceable to NIST USA

DATA
OUTPUT

**INSPECTION
CERTIFICATE**
TRACEABLE TO NIST

DIGITAL INDICATORS (ADVANCED TYPE)

7



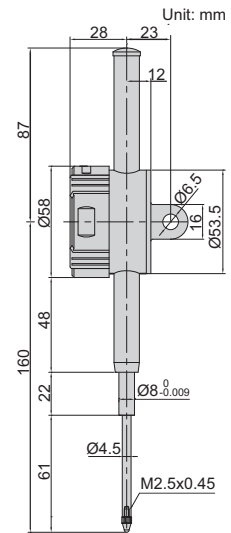
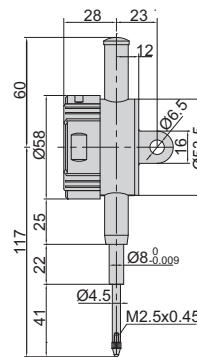
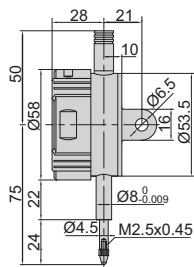
2103-10



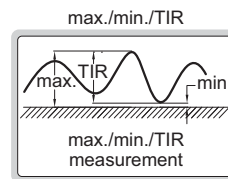
2104-25



2103-50



Unit: mm



- Reading in digital and analog
- Display can be rotated by 320°
- Button function: tolerance Go and No-Go display, data preset, measuring direction change, max./min./TIR measurement, inch/metric conversion, absolute/incremental measurement
- Keep preset data and tolerance data in memory after restart
- CR2032 battery, automatic power off, data output
- Optional accessory: data output cable (code 7315-50M, 7302-40M, 7305-40M), backs (page 149-150), contact points (page 146-148)

Resolution 0.001mm/0.0005"

Code	Range	Accuracy	Hysteresis	Remark
2103-10F *	12.7mm/0.5"	5µm	2µm	flat back
2103-25F *	25.4mm/1"	5µm	3µm	flat back
2103-50F *	50.8mm/2"	6µm	3µm	flat back
2103-10 *	12.7mm/0.5"	5µm	2µm	lug back
2103-25 *	25.4mm/1"	5µm	3µm	lug back
2103-50 *	50.8mm/2"	6µm	3µm	lug back

Resolution 0.01mm/0.0005"

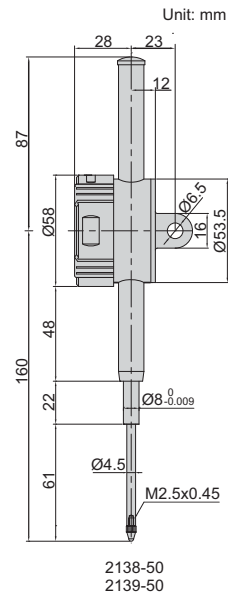
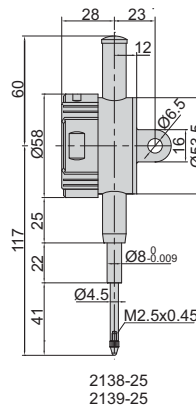
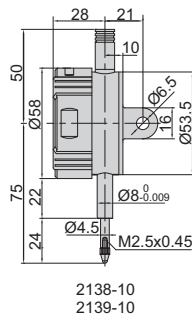
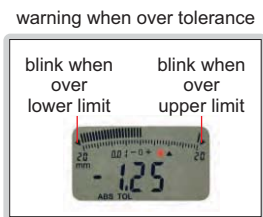
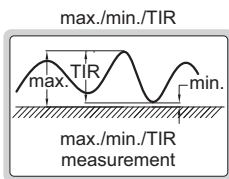
Code	Range	Accuracy	Hysteresis	Remark
2104-10F *	12.7mm/0.5"	20µm	10µm	flat back
2104-25F *	25.4mm/1"	20µm	10µm	flat back
2104-50F *	50.8mm/2"	30µm	10µm	flat back
2104-10 *	12.7mm/0.5"	20µm	10µm	lug back
2104-25 *	25.4mm/1"	20µm	10µm	lug back
2104-50 *	50.8mm/2"	30µm	10µm	lug back

* Supplied with manufacturer inspection certificate traceable to NIST USA

DIGITAL INDICATORS (WITH TRANSMIT BUTTON AND LIGHT)

**INSPECTION
CERTIFICATE**
TRACEABLE TO NIST

DATA
OUTPUT



- Reading in digital and analog
- Display can be rotated by 320°
- Button function: on/off, zero, tolerance Go and No-Go display, data preset, measuring direction change, max./min./TIR measurement, inch/metric conversion, absolute/incremental measurement, data output
- Keep preset data and tolerance data in memory after restart
- CR2032 battery, automatic power off
- Data output
- Optional accessory: data output cable, backs (page 149~150), contact points (page 146~148)

spindle lift knob is included



Resolution 0.001mm/0.00005"

Code	Range	Accuracy	Hysteresis	Remark
2138-10F*	12.7mm/0.5"	5µm	2µm	flat back
2138-25F*	25.4mm/1"	5µm	3µm	flat back
2138-50F*	50.8mm/2"	6µm	3µm	flat back
2138-10*	12.7mm/0.5"	5µm	2µm	lug back
2138-25*	25.4mm/1"	5µm	3µm	lug back
2138-50*	50.8mm/2"	6µm	3µm	lug back

Resolution 0.01mm/0.0005"

Code	Range	Accuracy	Hysteresis	Remark
2139-10F*	12.7mm/0.5"	20µm	10µm	flat back
2139-25F*	25.4mm/1"	20µm	10µm	flat back
2139-50F*	50.8mm/2"	30µm	10µm	flat back
2139-10*	12.7mm/0.5"	20µm	10µm	lug back
2139-25*	25.4mm/1"	20µm	10µm	lug back
2139-50*	50.8mm/2"	30µm	10µm	lug back

*Supplied with manufacturer inspection certificate traceable to NIST USA

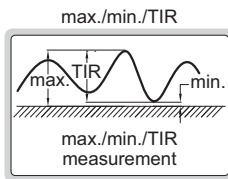
**INSPECTION
CERTIFICATE**
TRACEABLE TO NIST

WATERPROOF

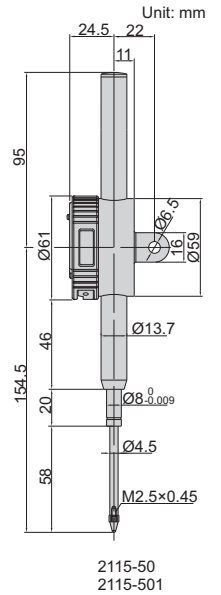
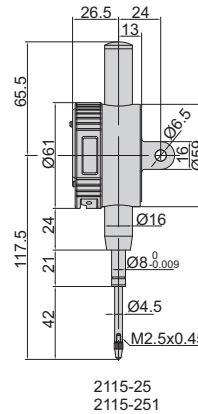
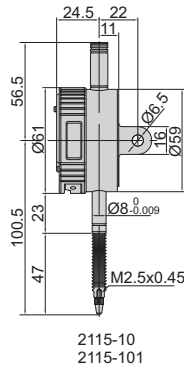
**DATA
OUTPUT**

WATERPROOF DIGITAL INDICATORS

7



- Dust/waterproof
- Button function: on/off, zero, mm/inch, data preset, tolerance, change measuring direction, max./min./TIR measurement, absolute/incremental measurement
- Keep preset data and tolerance data in memory after restart
- CR2032 battery, automatic power off
- Data output
- Optional accessory: data output cable (code 7315-50, 7302-SPC3A, 7305-C01), backs (page 149~150), contact points (page 146~148)



Resolution 0.001mm/0.00005"

Code	Range	Dust/waterproof	Accuracy	Hysteresis	Remark
2115-101 *	12.7mm/0.5"	IP65	5μm	2μm	lug back
2115-251 *	25.4mm/1"	IP54	5μm	3μm	lug back
2115-501 *	50.8mm/2"	IP54	6μm	3μm	lug back
2115-101F *	12.7mm/0.5"	IP65	5μm	2μm	flat back
2115-251F *	25.4mm/1"	IP54	5μm	3μm	flat back
2115-501F *	50.8mm/2"	IP54	6μm	3μm	flat back

Resolution 0.01mm/0.0005"

Code	Range	Dust/waterproof	Accuracy	Hysteresis	Remark
2115-10 *	12.7mm/0.5"	IP65	20μm	10μm	lug back
2115-25 *	25.4mm/1"	IP54	20μm	10μm	lug back
2115-50 *	50.8mm/2"	IP54	30μm	10μm	lug back
2115-10F *	12.7mm/0.5"	IP65	20μm	10μm	flat back
2115-25F *	25.4mm/1"	IP54	20μm	10μm	flat back
2115-50F *	50.8mm/2"	IP54	30μm	10μm	flat back

* Supplied with manufacturer inspection certificate traceable to NIST USA

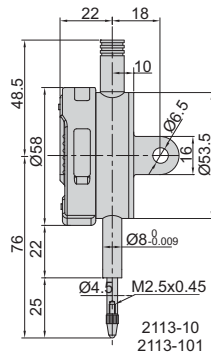
NO AUTO POWER OFF DIGITAL INDICATORS

ONE BATTERY FOR 4000 WORKING HOURS

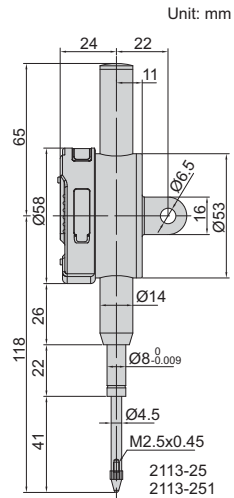
DATA OUTPUT

INSPECTION CERTIFICATE
TRACEABLE TO NIST

spindle lift knob is included



2113-10



Unit: mm



2113-251

- No auto power off, tracking the deformation of mould and steel structure for a long time
- Low power consumption
- Button function: on/off, zero, inch/mm, data preset, change measuring direction, absolute/incremental measurement
- Keep preset data in memory after restart
- CR2032 battery
- Data output
- Optional accessory: data output cable (code **7315-50M, 7302-40M, 7305-40M**), backs (page 149~150), contact points (page 146~148)

Resolution 0.001mm/0.00005"

Code	Range	Accuracy	Hysteresis	Remark
2113-101F*	12.7mm/0.5"	5µm	2µm	flat back
2113-251F*	25.4mm/1"	5µm	3µm	flat back
2113-101*	12.7mm/0.5"	5µm	2µm	lug back
2113-251*	25.4mm/1"	5µm	3µm	lug back

Resolution 0.01mm/0.0005"

Code	Range	Accuracy	Hysteresis	Remark
2113-10F*	12.7mm/0.5"	20µm	10µm	flat back
2113-25F*	25.4mm/1"	20µm	10µm	flat back
2113-10*	12.7mm/0.5"	20µm	10µm	lug back
2113-25*	25.4mm/1"	20µm	10µm	lug back

*Supplied with manufacturer inspection certificate traceable to NIST USA

DIGITAL INDICATORS (FOR HIGH SPEED MOVING OF SPINDLE)

DATA OUTPUT

INSPECTION CERTIFICATE
TRACEABLE TO NIST

ATTENTION: LARGE POWER CONSUMPTION, A BATTERY CAN BE USED FOR ABOUT HALF A YEAR

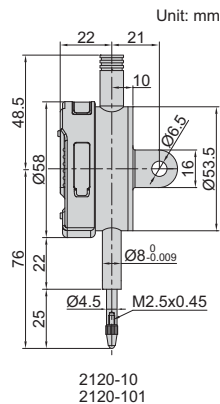
spindle lift knob is included



- For high speed moving of spindle
- Large power consumption, a battery can be used for about half a year
- Button function: on/off, inch/mm, zero, data preset, change measuring direction, absolute/incremental measurement
- Keep preset data in memory after restart
- CR2032 battery, automatic power off
- Data output
- Optional accessory: data output cable (code **7315-50M, 7302-40M, 7305-40M**), backs (page 149~150), contact points (page 146~148)

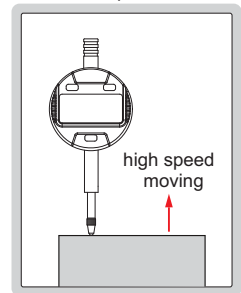


2120-10



Unit: mm

for high speed moving of spindle



Resolution 0.001mm/0.00005"

Code	Range	Accuracy	Hysteresis	Remark
2120-101F*	12.7mm/0.5"	5µm	2µm	flat back
2120-101*	12.7mm/0.5"	5µm	2µm	lug back

Resolution 0.01mm/0.0005"

Code	Range	Accuracy	Hysteresis	Remark
2120-10F*	12.7mm/0.5"	20µm	10µm	flat back
2120-10*	12.7mm/0.5"	20µm	10µm	lug back

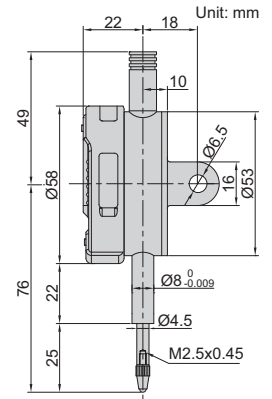
*Supplied with manufacturer inspection certificate traceable to NIST USA

ADJUSTABLE COEFFICIENT DIGITAL INDICATORS

- DISPLAY READING = COEFFICIENT X SPINDLE MOVEMENT.
The coefficient can be adjusted from 0 to 9.9999. For example, coefficient is 4.5562, spindle moves 3.60mm, display reading is $4.5562 \times 3.60 = 16.40\text{mm}$
- Button function: on/off, zero, data preset, inch/mm, coefficient set, measuring direction change
- Keep preset data in memory after restart
- CR2032 battery, automatic power off
- Data output
- Optional accessory: data output cable (code 7315-50M, 7302-40M, 7305-40M), backs (page 149-150), contact points (page 146-148)



2501-10



Code	Range	Resolution	Accuracy	Hysteresis	Remark
2501-10 *	12.7mm/0.5"	0.01mm/0.0005"	20µm	10µm	lug back
2501-10F *	12.7mm/0.5"	0.01mm/0.0005"	20µm	10µm	flat back

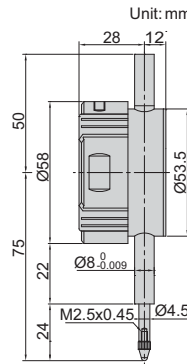
* Supplied with manufacturer inspection certificate traceable to NIST USA

- Specially designed for bore gages
- The minimum value tracking function can find the diameter automatically
- Read the diameter directly, after inputting the size of setting ring
- Reading in digital and analog
- Display can be rotated by 320°
- Button function: minimum value tracking, calibration, data preset, inch/metric conversion, absolute/incremental measurement
- Data remains after power off, no need to recalibrate after power on
- CR2032 battery, automatic power off
- Data output
- Optional accessory: data output cable (code 7315-50M, 7302-40M, 7305-40M), backs (page 149-150), contact points (page 146-148), spindle lift knob (code 7332)



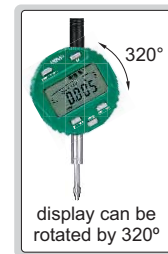
2108-10F

DIGITAL INDICATORS FOR BORE GAGES



THE ORIGINAL DATA REMAINS AFTER POWER OFF

DATA OUTPUT



INSPECTION CERTIFICATE
TRACEABLE TO NIST

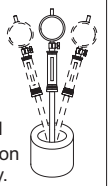
analog pointer



Read the diameter directly, after inputting the size of setting ring.



The minimum value tracking function can find the diameter automatically.

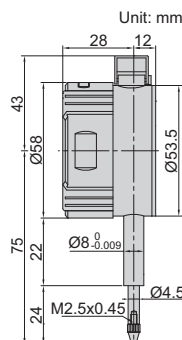


Code	Range	Resolution	Accuracy	Hysteresis	Remark
2108-10F *	12.7mm/0.5"	0.002mm/0.0001" (can switch to: 0.01mm/0.0005")	20µm	10µm	flat back
2108-101F *	12.7mm/0.5"	0.001mm/0.00005"	5µm	2µm	flat back

* Supplied with manufacturer inspection certificate traceable to NIST USA

DIGITAL INDICATORS WITH LIFTING LEVER

- Reading in digital and analog
- Display can be rotated by 320°
- Button function: tolerance Go and No-Go display, data preset, measuring direction change, max./min./TIR measurement, inch/metric conversion, absolute/incremental measurement
- Keep preset data and tolerance data in memory after restart
- CR2032 battery, automatic power off
- Data output
- Optional accessory: data output cable (code 7315-50M, 7302-40M, 7305-40M), backs (page 149-150), contact points (page 146-148)



2109-10

INSPECTION CERTIFICATE
TRACEABLE TO NIST

analog pointer



warning when over tolerance



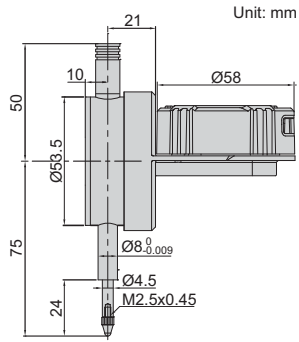
Code	Range	Resolution	Accuracy	Hysteresis	Remark
2109-10 *	10mm/0.4"	0.01mm/0.0005"	20µm	10µm	flat back
2109-101 *	10mm/0.4"	0.001mm/0.00005"	5µm	2µm	flat back

* Supplied with manufacturer inspection certificate traceable to NIST USA

BACK PLUNGER TYPE DIGITAL INDICATORS

DATA OUTPUT

INSPECTION CERTIFICATE
TRACEABLE TO NIST

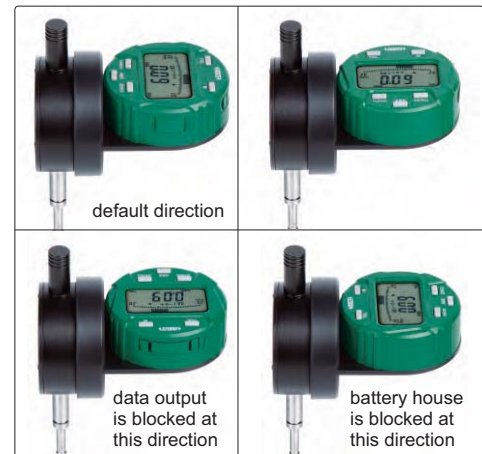


2118-10

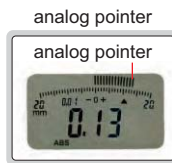
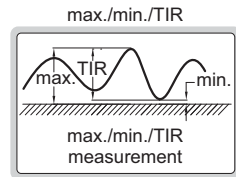
display can rotate 320°



display direction is changeable



Remark: To change above direction, 4 fixing screws on the back of display need to be removed first.



- Display can rotate 320°, and display direction is changeable
- Reading in digital and analog
- Button function: tolerance Go and No-Go display, data preset, measuring direction change, max./min./TIR measurement, inch/metric conversion, absolute/incremental measurement
- Keep preset data and tolerance data in memory after restart
- CR2032 battery, automatic power off
- Data output
- Optional accessory: data output cable (code 7315-50M, 7302-40M, 7305-40M), backs (page 149~150), contact points (page 146~148)

Code	Range	Resolution	Accuracy	Hysteresis	Remark
2118-10 *	12.7mm/0.5"	0.01mm/0.0005"	20µm	10µm	flat back
2118-101 *	12.7mm/0.5"	0.001mm/0.00005"	5µm	2µm	flat back

* Supplied with manufacturer inspection certificate traceable to NIST USA

COMPACT DIGITAL INDICATORS

DATA OUTPUT

INSPECTION CERTIFICATE
TRACEABLE TO NIST

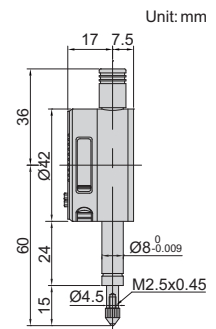
- Button function:
 - in/mm: short press for inch/metric conversion
 - long press to change measuring direction
 - ABS: short press for absolute/incremental measurement
 - long press to preset data
 - 0/ON: short press to turn on when power is off
 - short press to set zero when power is on
 - long press to turn off
- Keep preset data in memory after restart
- CR1632 battery, automatic power off
- Data output
- Optional accessory: data output cable (code 7315-50, 7302-SPC3A, 7305-C01), contact points (page 146~148)

Code	Range	Resolution	Accuracy	Hysteresis	Remark
2114-5F *	5mm/0.2"	0.01mm/0.0005"	20µm	10µm	flat back
2114-51F *	5mm/0.2"	0.001mm/0.00005"	5µm	2µm	flat back

* Supplied with manufacturer inspection certificate traceable to NIST USA



2114-51F



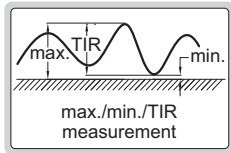
DATA OUTPUT

LARGE STROKE DIGITAL INDICATORS

spindle lift knob is included



max./min./TIR



warning when over tolerance



- Button function: on/off, zero, mm/inch, data preset, tolerance, change measuring direction, max./min./TIR measurement, absolute/incremental measurement
- Keep preset data and tolerance data in memory after restart
- CR2032 battery, automatic power off
- Data output
- Optional accessory: data output cable (code 7315-50, 7302-SPC3A, 7305-C01), backs (page 149~150), contact points (page 146~148)

Resolution 0.01mm/0.0005"

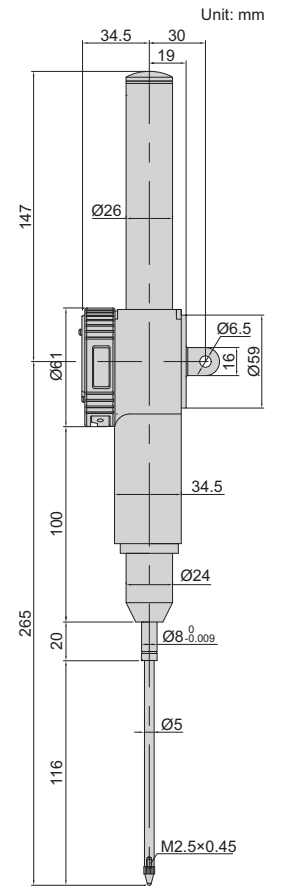
Code	Range	Accuracy	Hysteresis	Remark
2117-100	100mm/4"	30µm	10µm	lug back

Resolution 0.001mm/0.00005"

Code	Range	Accuracy	Hysteresis	Remark
2117-1001	100mm/4"	9µm	3µm	lug back



2117-100



ZEROING FOOT SWITCHES

- For zeroing of digital indicators



7360-1

application



Code	Description	Interface of digital indicators	Applicable products
7360-1	zeroing foot switch with cable (length 2.5m)		for digital indicators
7360-1M			

LINEAR GAGES AND DISPLAY UNIT

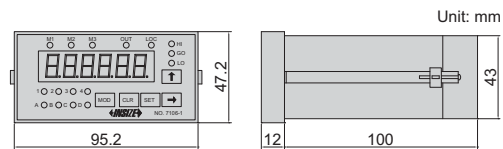
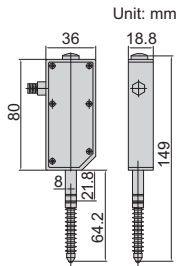
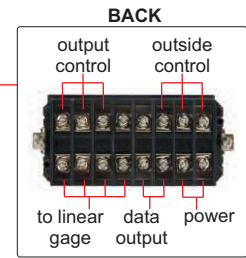
LINEAR GAGE
IP65
WATERPROOF



linear gage



display unit
7106-1



application



- Linear gage: shock-proof, water proof, dust proof, suitable for high speed movement, long working life
- Display unit: set tolerance and make judgment (out of upper tolerance, within tolerance, out of lower tolerance), output the judgment to control outside devices, set zero and hold reading from outside

LINEAR GAGE SPECIFICATION

Code	7106-11	7106-12
Measuring range	12mm/0.47"	12mm/0.47"
Resolution	0.01mm/0.0004"	0.001mm/0.00004"
Accuracy	20μm	5μm
Hysteresis	10μm	2μm
Measuring principle	capacity system	
Voltage	5V	
Sampling frequency	100 times/sec.	
Working life	ten million times	
Dust/waterproof	IP65	
Measuring force	1.5N	
Cable length	2m	
Data output	four-core wire	

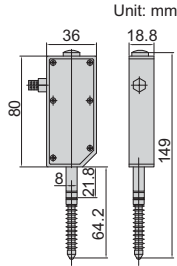
DISPLAY UNIT SPECIFICATION

Code	7106-1
Display	6 digits
Quantity of linear gages to be connected	1 pc
Tolerance	set tolerance and make judgment with alarm and lights (out of upper tolerance, within tolerance, out of lower tolerance)
Output control	output the tolerance judgment (out of upper tolerance, within tolerance, out of lower tolerance) to control outside devices
Outside control	control the display units from outside (set zero, hold reading)
Data output	connect to PC
Power supply	DC 9~24V

LINEAR GAGE
IP65
WATERPROOF



linear gage



software CD
(included)

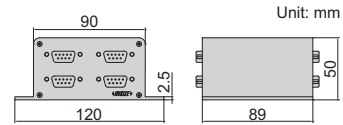
application

collect data

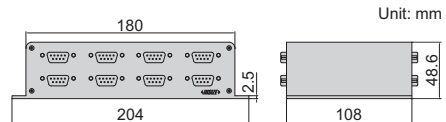
MULTI LINEAR GAGE SYSTEM



4-channel interface box
7107-1



8-channel interface box
7107-2



- Interface boxes are supplied with software. In the software, it is possible to set tolerance of each channel and show judgment (red when out of tolerance, green when within tolerance), set zero, collect data manually or automatically (time is adjustable), output data to Excel, print report.
- Connection box (code: 7107-3) is needed to connect interface boxes, when two or more interface boxes are used. Maximum 4 interface boxes can be connected.

LINEAR GAGE SPECIFICATION

Code	7107-11	7107-12
Measuring range	12mm/0.47"	12mm/0.47"
Resolution	0.01mm/0.0004"	0.001mm/0.00004"
Accuracy	20µm	5µm
Hysteresis	10µm	2µm
Measuring principle	capacity system	
Voltage	5V	
Sampling frequency	100 times/sec.	
Working life	ten million times	
Dust/waterproof	IP65	
Measuring force	1.5N	
Cable length	2m	
Data output	RS232	

INTERFACE BOX SPECIFICATION

Code	7107-1	7107-2
Quantity of linear gages to be connected	4 pcs	8 pcs
Data output	RS232 and RS485	
Power supply	DC 9~24V	

CONNECTION BOX (OPTIONAL) SPECIFICATION

Code	7107-3
Quantity of interface boxes to be connected	4 pcs (maximum 4 interface boxes can be connected)
Data output	RS232 and RS485
Power supply	DC 9~24V

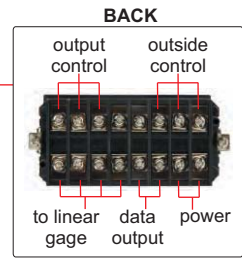
CABLE FOR DIGITAL INDICATORS AND DISPLAY UNIT



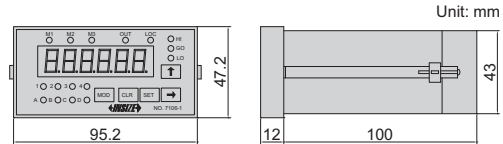
**cable of digital indicators
7309-B01M**



**display unit
7106-1**



application



- Display unit: set tolerance and make judgment (out of upper tolerance, within tolerance, out of lower tolerance), output the judgment to control outside devices, set zero and hold reading from outside, data preset, measuring direction change

CABLE SPECIFICATION

Code	Description	Plug to product	Socket on product	Applicable product
7309-B01M	cable of digital indicator (length 2.5m)			 digital indicators

DISPLAY UNIT SPECIFICATION

Code	7106-1
Display	6 digits
Quantity of digital indicator to be connected	1 pc
Tolerance	set tolerance and make judgment with alarm and lights (out of upper tolerance, within tolerance, out of lower tolerance)
Output control	output the tolerance judgment (out of upper tolerance, within tolerance, out of lower tolerance) to control outside devices
Outside control	control the display units from outside (set zero, hold reading)
Data output	connect to PC
Power supply	DC 9~24V



CABLE FOR DIGITAL INDICATORS AND MULTI CHANNEL INTERFACE BOX

application



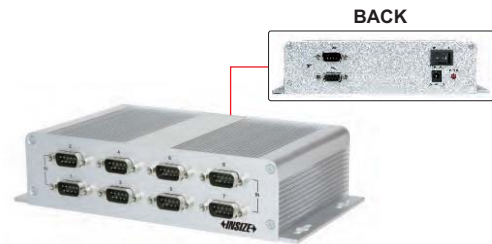
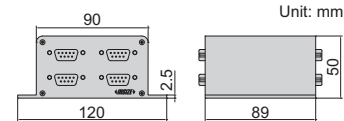
software CD (included)



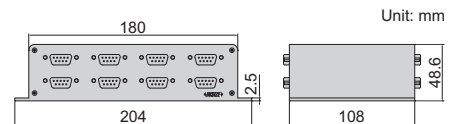
cable of digital indicators
7309-C01M



4-channel interface box
7107-1



8-channel interface box
7107-2



- Interface boxes are supplied with software. In the software, it is possible to set tolerance of each channel and show judgment (red when out of tolerance, green when within tolerance), set zero, collect data manually or automatically (time is adjustable), output data to Excel, print report.
- Connection box (code: 7107-3) is needed to connect interface boxes, when two or more interface boxes are used. Maximum 4 interface boxes can be connected.

CABLE SPECIFICATION

Code	Description	Plug to product	Socket on product	Applicable product
7309-C01M	cable of digital indicator (length 2 m)			 digital indicators

INTERFACE BOX SPECIFICATION

Code	7107-1	7107-2
Quantity of digital indicators to be connected	4 pcs	8 pcs
Data output	RS232 and RS485	
Power supply	DC 9~24V	

CONNECTION BOX (OPTIONAL) SPECIFICATION

Code	7107-3
Quantity of interface boxes to be connected	4 pcs (maximum 4 interface boxes can be connected)
Data output	RS232 and RS485
Power supply	DC 9~24V

PRECISION DIAL INDICATORS

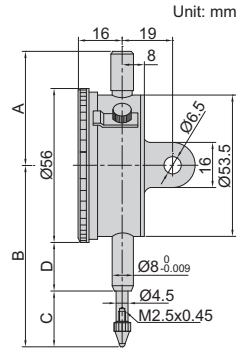
- Graduation: 0.001mm
- Jeweled bearing
- Supplied with limit pointers and bezel clamp
- Optional accessory: backs (page 149~150), contact points (page 146~148)



2313-1A

JEWELLED BEARING

INSPECTION CERTIFICATE TRACEABLE TO NIST



Code	Range	Accuracy	Hysteresis	Range/rev	Dial reading	Remark	A	B	C	D
2313-1FA *	1mm	5µm	2µm	0.2mm	0-100-0	flat back	45	62.5	19.5	15
2313-2FA *	2mm	6µm	2.5µm	0.2mm	0-100-0	flat back	45	62.5	19.5	15
2313-1A *	1mm	5µm	2µm	0.2mm	0-100-0	lug back	45	62.5	19.5	15
2313-2A *	2mm	6µm	2.5µm	0.2mm	0-100-0	lug back	45	62.5	19.5	15

*Supplied with manufacturer inspection certificate traceable to NIST USA

COMPACT DIAL INDICATORS

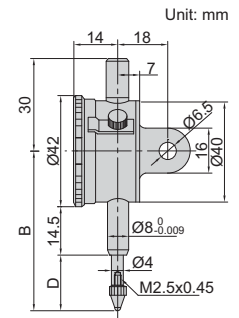
- Meet DIN878
- Jeweled bearing
- Supplied with limit pointers and bezel clamp
- Optional accessory: backs (page 149~150), contact points (page 146~148)



2311-5

JEWELLED BEARING

INSPECTION CERTIFICATE TRACEABLE TO NIST



Code	Range	Graduation	Accuracy	Hysteresis	Range/rev	Dial reading	Remark	B	D
2311-3F *	3mm	0.01mm	12µm	3µm	0.5mm	0-50	flat back	46	10.5
2311-5F *	5mm	0.01mm	14µm	3µm	0.5mm	0-50	flat back	48	12.5
2311-3 *	3mm	0.01mm	12µm	3µm	0.5mm	0-50	lug back	46	10.5
2311-5 *	5mm	0.01mm	14µm	3µm	0.5mm	0-50	lug back	48	12.5

*Supplied with manufacturer inspection certificate traceable to NIST USA

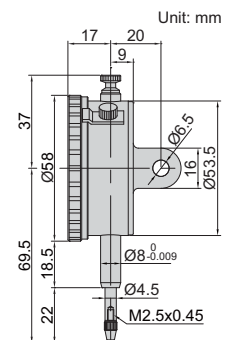
DIAL INDICATORS (BASIC TYPE)

- Meet DIN878
- Jeweled bearing
- Supplied with limit hands and bezel clamp
- Packed in carton box
- Optional accessory: backs (page 149~150), contact points (page 146~148)



2301-10

INSPECTION CERTIFICATE TRACEABLE TO NIST



Code	Range	Graduation	Accuracy	Hysteresis	Range/rev	Dial reading	Remark
2301-10F *	10mm	0.01mm	17µm	3µm	1mm	0-100	flat back
2301-10 *	10mm	0.01mm	17µm	3µm	1mm	0-100	lug back with spare flat back

*Supplied with manufacturer inspection certificate traceable to NIST USA



JEWELLED BEARING

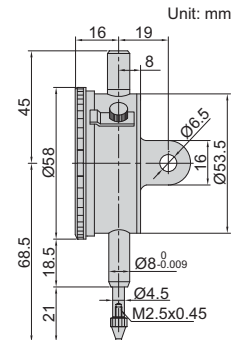
DIAL INDICATORS (STANDARD TYPE)

- Meet DIN878
- Jeweled bearing
- Supplied with limit pointers and bezel clamp
- Optional accessory: backs (page 149~150), contact points (page 146~148)



2308-10A

Code	Range	Graduation	Accuracy	Hysteresis	Range/rev	Dial reading	Remark
2308-3FA *	3mm	0.01mm	12μm	3μm	1mm	0-100	flat back
2308-5FA *	5mm	0.01mm	14μm	3μm	1mm	0-100	flat back
2308-10FA *	10mm	0.01mm	17μm	3μm	1mm	0-100	flat back
2308-3A *	3mm	0.01mm	12μm	3μm	1mm	0-100	lug back
2308-5A *	5mm	0.01mm	14μm	3μm	1mm	0-100	lug back
2308-10A *	10mm	0.01mm	17μm	3μm	1mm	0-100	lug back



*Supplied with manufacturer inspection certificate traceable to NIST USA



JEWELLED BEARING

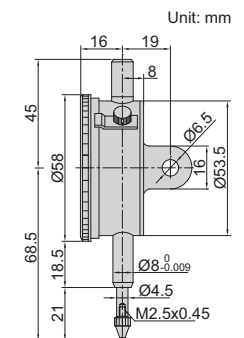
REVERSE READING DIAL INDICATORS

- Meet DIN878
- Suitable for depth and step measurements
- Jeweled bearing
- Supplied with limit pointers and bezel clamp
- Optional accessory: backs (page 149~150), contact points (page 146~148)



2801-10

Code	Range	Graduation	Accuracy	Hysteresis	Range/rev	Dial reading	Remark
2801-10F *	10mm	0.01mm	17μm	3μm	1mm	100-0	flat back
2801-10 *	10mm	0.01mm	17μm	3μm	1mm	100-0	lug back



*Supplied with manufacturer inspection certificate traceable to NIST USA



SHOCK PROOF

JEWELLED BEARING

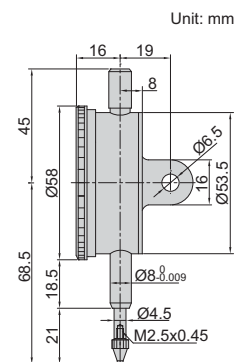
SHOCKPROOF DIAL INDICATORS

- Meet DIN878
- Shockproof
- Jeweled bearing
- Supplied with limit pointers and bezel clamp
- Optional accessory: backs (page 149~150), contact points (page 146~148)



2314-10A

Code	Range	Graduation	Accuracy	Hysteresis	Range/rev	Dial reading	Remark
2314-3FA *	3mm	0.01mm	12μm	3μm	1mm	0-100	flat back
2314-5FA *	5mm	0.01mm	14μm	3μm	1mm	0-100	flat back
2314-10FA *	10mm	0.01mm	17μm	3μm	1mm	0-100	flat back
2314-3A *	3mm	0.01mm	12μm	3μm	1mm	0-100	lug back
2314-5A *	5mm	0.01mm	14μm	3μm	1mm	0-100	lug back
2314-10A *	10mm	0.01mm	17μm	3μm	1mm	0-100	lug back



*Supplied with manufacturer inspection certificate traceable to NIST USA

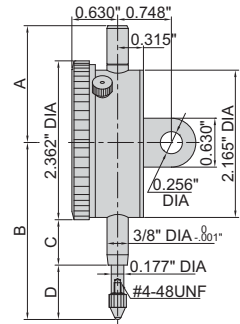
INCH DIAL INDICATORS

- Meet ASME B89.1.10M-2001
- With lug back
- Supplied with limit pointers and bezel clamp



2307-1

**INSPECTION
CERTIFICATE**
TRACEABLE TO NIST



Range	A	B	C	D
0.25"	1.811"	2.953"	0.787"	0.984"
0.5"	1.811"	2.953"	0.787"	0.984"
1"	1.811"	3.346"	0.787"	1.378"
2"	4.370"	5.472"	1.969"	2.323"

* Supplied with manufacturer inspection certificate traceable to NIST

7

WATERPROOF DIAL INDICATORS

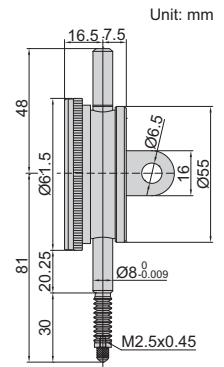
- Meet DIN878
- IP54 dust/waterproof
- With limit pointers
- Optional accessory: backs (page 149~150), contact points (page 146~148)



2324-10A

**IP54
WATERPROOF**

**INSPECTION
CERTIFICATE**
TRACEABLE TO NIST



Code	Range	Graduation	Accuracy	Hysteresis	Range/rev	Dial reading	Remark
2324-10FA *	10mm	0.01mm	17µm	3µm	1mm	0-100	flat back
2324-10A *	10mm	0.01mm	17µm	3µm	1mm	0-100	lug back

* Supplied with manufacturer inspection certificate traceable to NIST USA

DOUBLE FACE DIAL INDICATOR

- Meet DIN878
- Read from both sides
- Jeweled bearing
- Supplied with limit pointers
- Optional accessory: contact points (page 146~148)

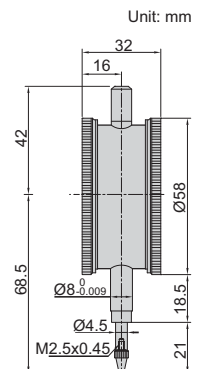


front

2328-10

back

**INSPECTION
CERTIFICATE**
TRACEABLE TO NIST



Code	Range	Graduation	Accuracy	Hysteresis	Range/rev	Dial reading
2328-10*	10mm	0.01mm	17µm	3µm	1mm	0-100

* Supplied with manufacturer inspection certificate traceable to NIST USA

DIAL INDICATORS (LONG STROKE)

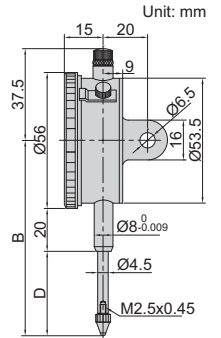


2310-30A

- Supplied with limit pointers and bezel clamp
- Optional accessory: backs (page 149~150), contact points (page 146~148)

Code	Range	Graduation	Accuracy	Hysteresis	Range/rev	Dial reading	Remark	B	D
2310-20FA *	20mm	0.01mm	25µm	5µm	1mm	0-100	flat back	83	35
2310-30FA *	30mm	0.01mm	35µm	7µm	1mm	0-100	flat back	88	40
2310-20A *	20mm	0.01mm	25µm	5µm	1mm	0-100	lug back	83	35
2310-30A *	30mm	0.01mm	35µm	7µm	1mm	0-100	lug back	88	40

*Supplied with manufacturer inspection certificate traceable to NIST USA



DIAL INDICATORS (LONG STROKE, BASIC TYPE)



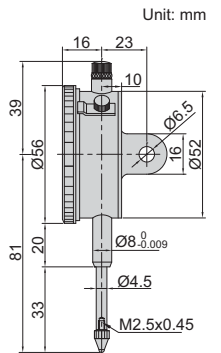
2302-25

- Supplied with limit pointers and bezel clamp
- Packed in carton box
- Optional accessory: backs (page 149~150), contact points (page 146~148)



Code	Range	Graduation	Accuracy	Hysteresis	Range/rev	Dial reading	Remark
2302-25F *	25mm	0.01mm	35µm	7µm	1mm	0-100	flat back
2302-25 *	25mm	0.01mm	35µm	7µm	1mm	0-100	lug back with spare flat back

*Supplied with manufacturer inspection certificate traceable to NIST USA



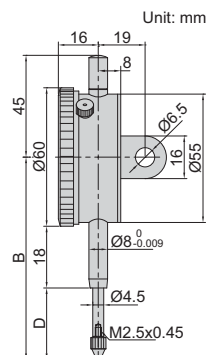
DIAL INDICATORS (GRADUATION 0.1mm)



2318-30

- Supplied with limit pointers and bezel clamp
- Optional accessory: backs (page 149~150), contact points (page 146~148)

Code	Range	Graduation	Accuracy	Hysteresis	Range/rev	Dial reading	Remark	B	D
2318-10F	10mm	0.1mm	40µm	20µm	10mm	0-10	flat back	70	20
2318-20F	20mm	0.1mm	50µm	20µm	10mm	0-10	flat back	85	35
2318-25F	25mm	0.1mm	60µm	20µm	10mm	0-10	flat back	85	35
2318-30F	30mm	0.1mm	60µm	20µm	10mm	0-10	flat back	90	40
2318-10	10mm	0.1mm	40µm	20µm	10mm	0-10	lug back	70	20
2318-20	20mm	0.1mm	50µm	20µm	10mm	0-10	lug back	85	35
2318-25	25mm	0.1mm	60µm	20µm	10mm	0-10	lug back	85	35
2318-30	30mm	0.1mm	60µm	20µm	10mm	0-10	lug back	90	40



ONE REVOLUTION DIAL INDICATORS

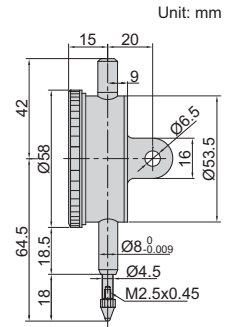
SHOCK PROOF

INSPECTION CERTIFICATE
TRACEABLE TO NIST

- Meet DIN878
- Eliminate the possibility of reading errors due to miscounting
- Shockproof
- Supplied with limit pointers
- Optional accessory: backs (page 149~150), contact points (page 146~148)



2316-05



Code	Range	Dial indicator stroke	Graduation	Accuracy	Hysteresis	Dial reading	Remark
2316-05F *	0.5mm	5mm	0.01mm	9µm	3µm	25-0-25	flat back
2316-1F *	1mm	5mm	0.01mm	9µm	3µm	50-0-50	flat back
2316-05 *	0.5mm	5mm	0.01mm	9µm	3µm	25-0-25	lug back
2316-1 *	1mm	5mm	0.01mm	9µm	3µm	50-0-50	lug back

*Supplied with manufacturer inspection certificate traceable to NIST USA

DIAL INDICATORS (LONG STROKE)

JEWELLED BEARING

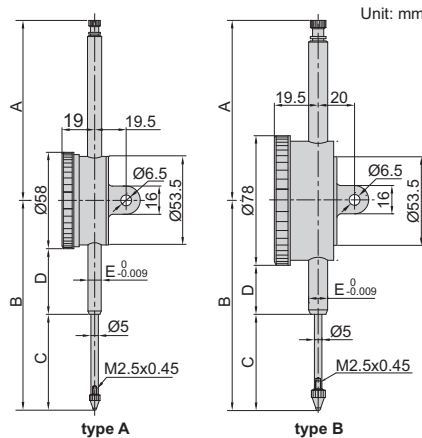
SHOCK PROOF

INSPECTION CERTIFICATE
TRACEABLE TO NIST

- Shockproof
- Jeweled bearing
- Supplied with limit pointers
- Optional accessory: backs (page 149~150), contact points (page 146~148)



2309-50



stem clamp Ø10mm for 2309-100D



back of type B



Code	Type	A	B	C	D	E
2309-30F	A	37.5	89.5	40.9	19.5	Ø8
2309-30	A	37.5	89.5	40.9	19.5	Ø8
2309-50	A	108.3	126.2	57.7	39.5	Ø8
2309-50D	B	108.3	126.2	57.7	29.5	Ø8
2309-80	A	138.4	168.4	88	51.3	Ø8
2309-80D	B	138.4	168.4	88	41.3	Ø8
2309-100D	B	167.6	207.8	108	60.8	Ø10

Code	Range	Graduation	Type	Accuracy	Hysteresis	Range/rev	Dial reading	Remark
2309-30F *	30mm	0.01mm	A	35µm	7µm	1mm	0-100	flat back
2309-30 *	30mm	0.01mm	A	35µm	7µm	1mm	0-100	lug back
2309-50 *	50mm	0.01mm	A	40µm	8µm	1mm	0-100	flat back with spare lug back
2309-50D *	50mm	0.01mm	B	40µm	8µm	1mm	0-100	flat back with spare lug back
2309-80	80mm	0.01mm	A	50µm	9µm	1mm	0-100	flat back with spare lug back
2309-80D	80mm	0.01mm	B	50µm	9µm	1mm	0-100	flat back with spare lug back
2309-100D	100mm	0.01mm	B	50µm	9µm	1mm	0-100	flat back with spare lug back

Note: 1) 2309-80, 2309-80D and 2309-100D can only be used vertically
 2) 2309-100D is supplied with stem clamp Ø10mm for magnetic stands (code 6200-60, 6201-60, 6202-80, 6202-100)
 3) 2309-30 and 2309-30F can not accept optional backs (page 149~150)

*Supplied with manufacturer inspection certificate traceable to NIST USA

INCH LONG STROKE DIAL INDICATORS



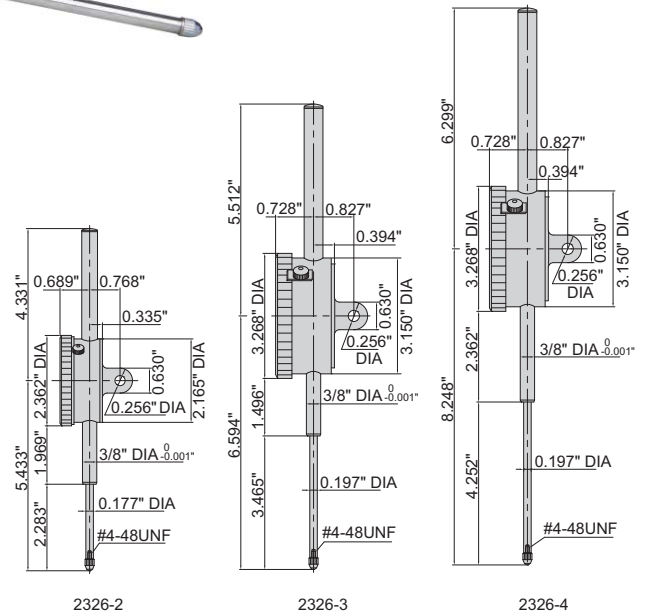
2326-2

- Graduation 0.001"
- With lug back
- Supplied with limit pointers and bezel clamp

Code	Range	Accuracy		Range/rev	Dial reading
		First 2.5 rev	Overall		
2326-2 *	2"	±0.001"	±0.004"	0.1"	0-100
2326-3 **	3"	±0.001"	±0.005"	0.1"	0-100
2326-4 **	4"	±0.001"	±0.005"	0.1"	0-100

* Supplied with manufacturer inspection certificate traceable to NIST

** 2326-3 and 2326-4 can only be used vertically



Code	Material of measuring face	L (mm)
6282-0101	carbide	7.3
6282-0103	ceramic	7.3
6282-0104	carbide	8.3
6282-0106	carbide	12.1
6282-0107	carbide	14
6282-0108	carbide	15
6282-0109	ceramic	15
6282-0110	carbide	17

Code	Material of measuring face	L (mm)
6282-0111	carbide	19.3
6282-0112	carbide	20
6282-0113	ceramic	20
6282-0114	carbide	22
6282-0115	carbide	25
6282-0116	ceramic	25
6282-0117	carbide	30
6282-0118	ceramic	30

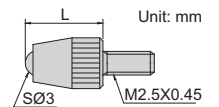
Code	Material of measuring face	SØD (mm)
6282-0301	steel	1
6282-0302	carbide	1.5
6282-0303	carbide	1.8

Code	Material of measuring face	SØD (mm)
6282-0304	carbide	2.5
6282-0305	carbide	4

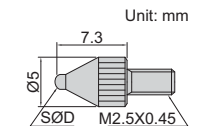
BALL POINTS



6282-0101



6282-0301



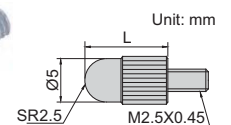
Code	Material of measuring face	L (mm)
6282-0202	steel	5
6282-0203	steel	10
6282-0205	steel	15

Code	Material of measuring face	L (mm)
6282-0207	steel	20
6282-0208	steel	25
6282-0210	steel	30

SHELL TYPE POINTS



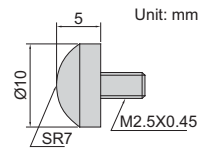
6282-0202



SPHERICAL POINT



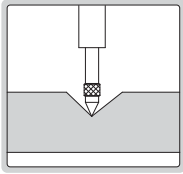
6282-0401



Code	Material of measuring face
6282-0401	steel

CONICAL POINTS

7



6282-0601



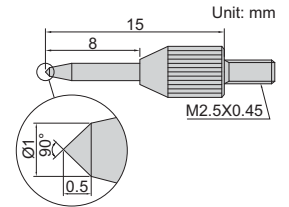
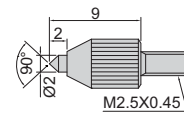
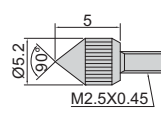
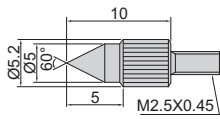
6282-0701



6282-0801



6282-0901

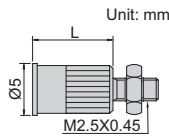


Code	Material of measuring face
6282-0601	steel
6282-0701	steel
6282-0801	steel
6282-0901	steel

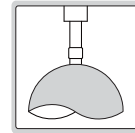
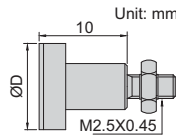
FLAT POINTS



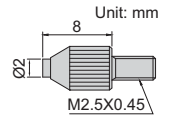
6282-1101



6282-1201



6282-1301

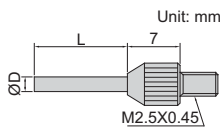


Code	Material of measuring face	L (mm)
6282-1101	steel	8
6282-1102	steel	10

Code	Material of measuring face	ØD (mm)
6282-1201	steel	10
6282-1202	steel	15
6282-1203	steel	20
6282-1204	steel	25
6282-1205	steel	30

Code	Material of measuring face
6282-1301	carbide

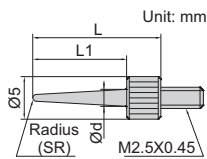
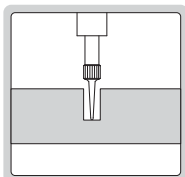
NEEDLE POINTS



6282-1711

Code	Material of measuring face	ØD (mm)	L (mm)
6282-1701	steel	0.45	3
6282-1702	steel	0.45	5
6282-1703	carbide	1	3
6282-1704	carbide	1	5
6282-1705	carbide	1	8
6282-1706	carbide	1	10
6282-1707	carbide	1	20
6282-1708	carbide	1	40
6282-1709	carbide	1.5	5

Code	Material of measuring face	ØD (mm)	L (mm)
6282-1710	carbide	1.5	10
6282-1711	carbide	1.5	13
6282-1712	carbide	1.5	20
6282-1713	carbide	1.5	40
6282-1714	carbide	2	8
6282-1715	carbide	2	18
6282-1716	carbide	2	28
6282-1717	carbide	2	40

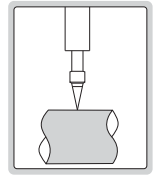
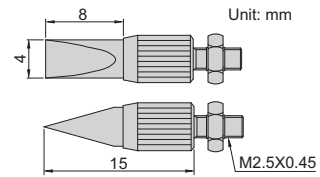


6282-1601

Code	Material of measuring face	L1 (mm)	L (mm)	SR (mm)	Ød (mm)
6282-1601	steel	11	15	0.4	2
6282-1602	steel	13	17	0.2	2
6282-1603	steel	21	25	0.4	3
6282-1604	steel	31	35	0.4	3

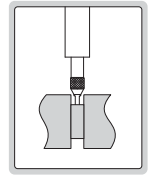
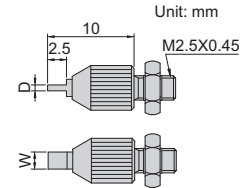
KNIFE EDGE POINT

Code	Material of measuring face
6282-1001	steel



BLADE POINTS

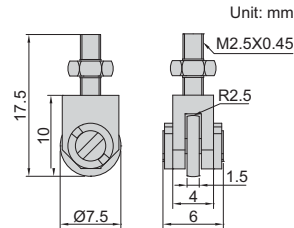
Code	Material of measuring face	D	W
6282-1801	steel	0.4mm	2mm
6282-1802	steel	0.6mm	2mm
6282-1803	steel	1mm	4mm



7

ROLLER POINT

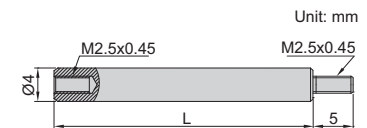
Code	Material of measuring face
6282-1901	steel



EXTENSION RODS

Code	Material	L (mm)
6282-2001	steel	10
6282-2002	steel	15
6282-2003	steel	20
6282-2004	steel	25
6282-2005	steel	30
6282-2006	steel	35
6282-2007	steel	40
6282-2008	steel	45
6282-2009	steel	50

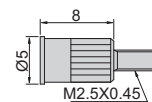
Code	Material	L (mm)
6282-2010	steel	55
6282-2011	steel	60
6282-2012	steel	65
6282-2013	steel	70
6282-2014	steel	75
6282-2015	steel	80
6282-2016	steel	90
6282-2017	steel	100



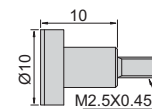
6282-S6

Code	Material of measuring face
6282-S6	steel

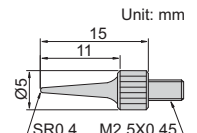
POINT SET



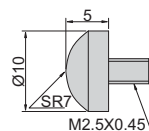
Flat Point



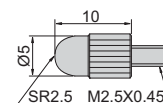
Flat Point



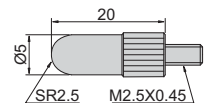
Needle Point



Spherical Point



Shell Type Point



Shell Type Point

SPINDLE LIFT KNOB

- For dial/digital indicators with spindle diameter $\varnothing 4.5\text{mm}$ or $\varnothing 5\text{mm}$

Code
7332



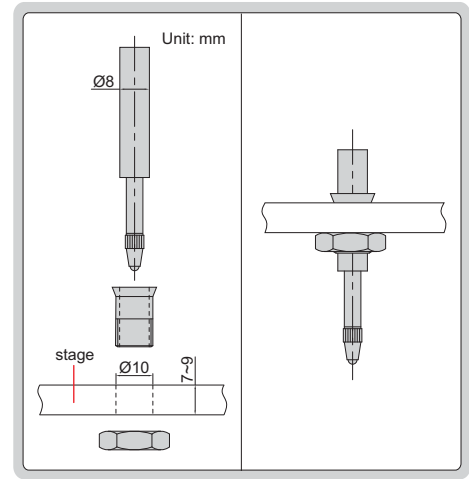
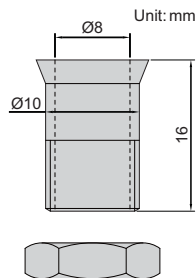
7332

SHAFT SLEEVE

7



7333



- For dial indicators and probes with shaft diameter $\varnothing 8\text{mm}$

Code
7333

MAGNETIC BACKS

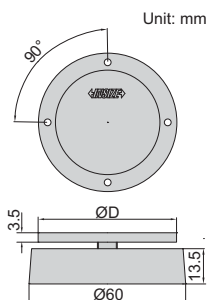


front



back

7331-M2



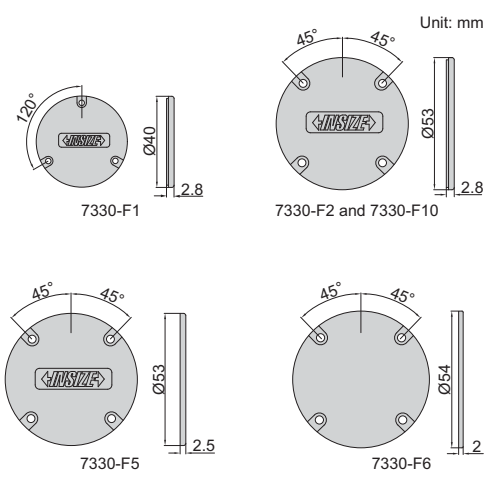
Code	ØD	For digital/dial indicators
7331-M1	51.5mm	2103
		2104
		2108
		2109
		2112
		2113
		2115
		2116
		2117
		2118
		2120
		2501
		2301
		2302
		2308
		2309 (except 2309-30, 2309-30F)
		2313
2314		
2316		
2324		
2801		
7331-M2	54mm	2318



FLAT BACKS



7330-F2



Code	For digital/dial indicators
7330-F1	2311
	2301
	2302
	2308
	2309 (except 2309-30, 2309-30F)
	2801
7330-F2	2313
	2314
	2316
	2324
	2801

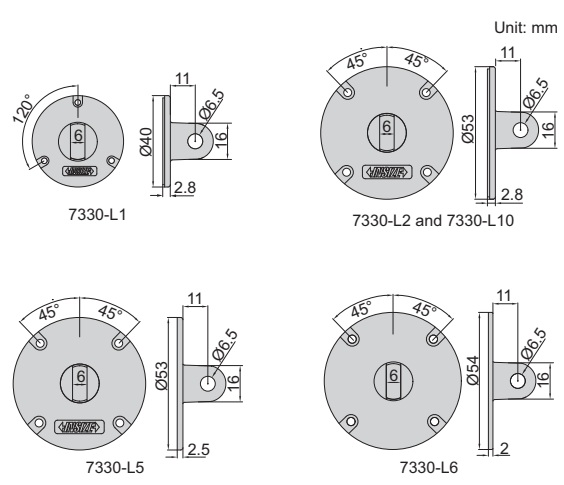
Code	For digital/dial indicators
7330-F5	2103
	2104
	2108
	2109
	2112
	2113
	2115
	2116
	2117
	2118
	2120
2501	
7330-F6	2318
7330-F10	2310

7

LUG BACKS



7330-L2

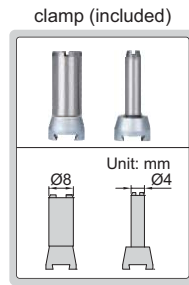


Code	For digital/dial indicators
7330-L1	2311
	2301
	2302
	2308
	2309 (except 2309-30, 2309-30F)
	2801
7330-L2	2313
	2314
	2316
	2324
	2801

Code	For digital/dial indicators
7330-L5	2103
	2104
	2108
	2109
	2112
	2113
	2115
	2116
	2117
	2118
	2120
2501	
7330-L6	2318
7330-L10	2310

DIAL TEST INDICATORS

- Meet DIN2270 (except 2380-02, 2381-02)
- Jeweled bearing
- Carbide contact point
- Two measuring directions
- Anti magnetic body
- Supplied with two clamps: diameter Ø4mm and Ø8mm
- Optional accessory: styli (page 153)



2380-08

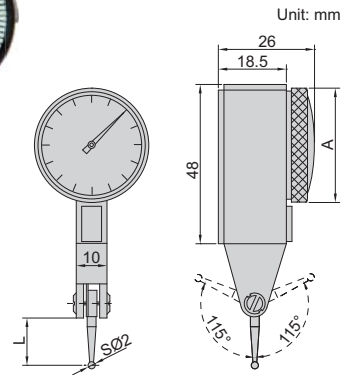
(mm)

Code	Range	Graduation	Accuracy	Hysteresis	Dial reading	A	L
2380-08*	0.8mm	0.01mm	13µm	3µm	0-40-0	Ø30	13.5
2381-08*	0.8mm	0.01mm	13µm	3µm	0-40-0	Ø37	13.5
2380-02*	0.2mm	0.002mm	6µm	2µm	0-100-0	Ø30	12.5
2381-02*	0.2mm	0.002mm	6µm	2µm	0-100-0	Ø37	12.5

*Supplied with manufacturer inspection certificate traceable to NIST USA

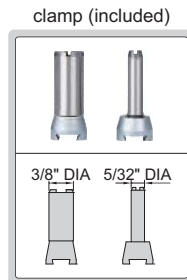
JEWELLED BEARING

INSPECTION CERTIFICATE TRACEABLE TO NIST



INCH DIAL TEST INDICATORS

- Jeweled bearing
- Carbide contact point
- Two measuring directions
- Anti magnetic body
- Supplied with two clamps: 5/32" DIA and 3/8" DIA



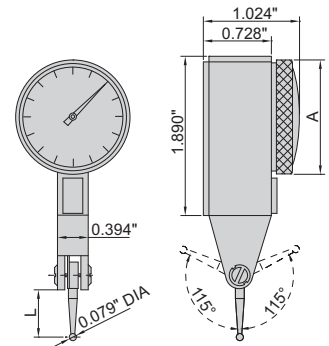
2380-31

Code	Range	Graduation	Accuracy	Dial reading	A	L
2380-31*	0.03"	0.001"	±0.001"	0-15-0	1.181" DIA	0.50"
2380-35*	0.03"	0.0005"	±0.0005"	0-15-0	1.181" DIA	0.50"
2380-301*	0.008"	0.0001"	±0.0001"	0-40-0	1.181" DIA	0.563"
2381-31*	0.03"	0.001"	±0.001"	0-15-0	1.457" DIA	0.50"
2381-35*	0.03"	0.0005"	±0.0005"	0-15-0	1.457" DIA	0.50"
2381-301*	0.008"	0.0001"	±0.0001"	0-40-0	1.457" DIA	0.563"

*Supplied with manufacturer inspection certificate traceable to NIST

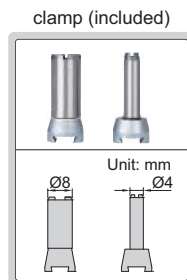
JEWELLED BEARING

INSPECTION CERTIFICATE TRACEABLE TO NIST



VERTICAL TYPE DIAL TEST INDICATOR

- Meet DIN2270
- Jeweled bearing
- Carbide contact point
- Two measuring directions
- Anti magnetic body
- Supplied with two clamps: diameter Ø4mm and Ø8mm
- Optional accessory: styli (page 153)



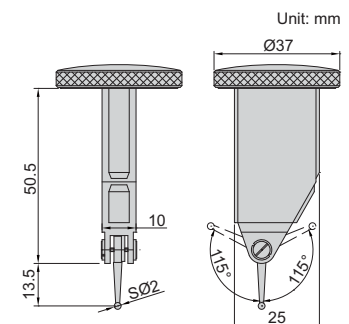
2398-08

Code	Range	Graduation	Accuracy	Hysteresis	Dial reading
2398-08*	0.8mm	0.01mm	13µm	3µm	0-40-0

*Supplied with manufacturer inspection certificate traceable to NIST USA

JEWELLED BEARING

INSPECTION CERTIFICATE TRACEABLE TO NIST



**INSPECTION
CERTIFICATE**
TRACEABLE TO NIST

JEWELLED
BEARING

TILTED FACE TYPE DIAL TEST INDICATOR

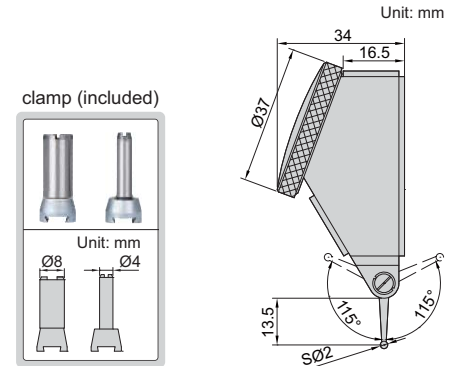
- Meet DIN2270
- Jeweled bearing
- Carbide contact point
- Two measuring directions
- Anti magnetic body
- Supplied with two clamps:
diameter Ø4mm and Ø8mm
- Optional accessory: styli (page 153)



2399-08

Code	Range	Graduation	Accuracy	Hysteresis	Dial reading
2399-08*	0.8mm	0.01mm	13µm	3µm	0-40-0

*Supplied with manufacturer inspection certificate traceable to NIST USA



**INSPECTION
CERTIFICATE**
TRACEABLE TO NIST

JEWELLED
BEARING

LONG STYLUS DIAL TEST INDICATOR

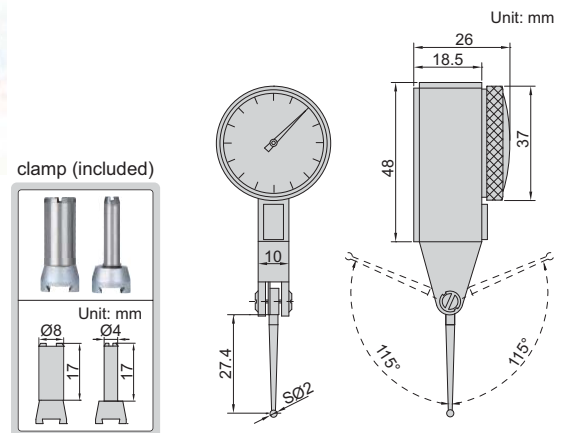
- Meet DIN2270
- Jeweled bearing
- Carbide contact point
- Two measuring directions
- Anti magnetic body
- Supplied with two clamps:
diameter Ø4mm and Ø8mm
- Optional accessory: styli (page 153)



2383-08A

Code	Range	Graduation	Accuracy	Hysteresis	Dial reading
2383-08A*	0.8mm	0.01mm	13µm	3µm	0-40-0

*Supplied with manufacturer inspection certificate traceable to NIST USA



**INSPECTION
CERTIFICATE**
TRACEABLE TO NIST

JEWELLED
BEARING

LARGE RANGE DIAL TEST INDICATOR

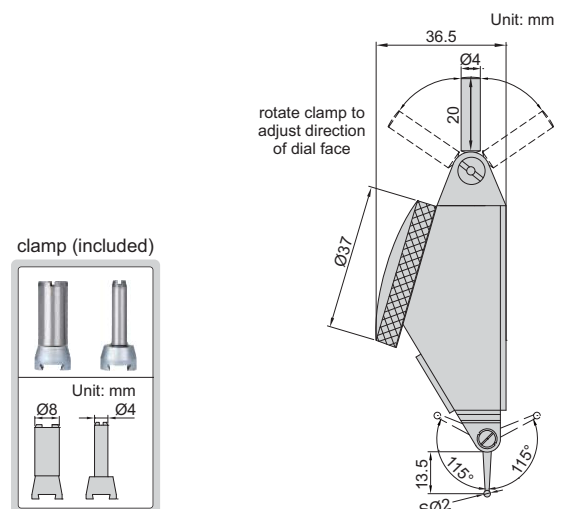
- Dial reading: 0-40-0
- Jeweled bearing
- Carbide contact point
- Two measuring directions
- Anti magnetic body
- Supplied with two clamps:
diameter Ø4mm and Ø8mm
- Optional accessory: styli (page 153)



2386-16A

Code	Range	Graduation	Accuracy	Hysteresis
2386-16A*	1.6mm	0.01mm	25µm	8µm

*Supplied with manufacturer inspection certificate traceable to NIST USA

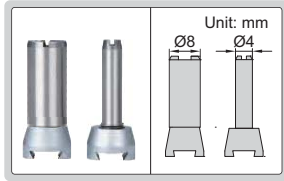


LARGE RANGE VERTICAL TYPE DIAL TEST INDICATOR

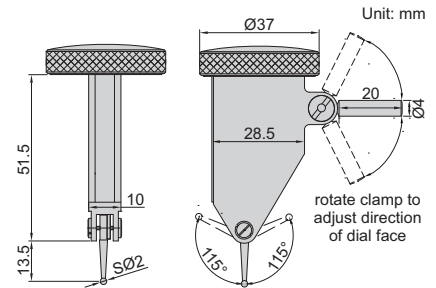
JEWELLED BEARING

INSPECTION CERTIFICATE
TRACEABLE TO NIST

clamp (included)



2480-16



- Dial Reading: 0-40-0
- Jeweled bearing
- Carbide contact point
- Two measuring directions
- Anti magnetic body
- Supplied with two clamps: diameter Ø4mm and Ø8mm
- Optional accessory: styli (page 153)

Code	Range	Graduation	Accuracy	Hysteresis
2480-16*	1.6mm	0.01mm	18µm	3µm

* Supplied with manufacturer inspection certificate traceable to NIST USA

CLAMPS FOR DIAL TEST INDICATORS



6298-1



6298-2

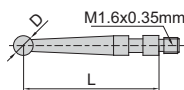


Code	ØD
6298-1	Ø4mm
6298-2	Ø8mm

STYLI FOR DIAL TEST INDICATORS



6284-3



Code	For dial test indicator	Material of contact point	L	D
6284-1	2380-08	steel	13.5mm	SØ1mm
6284-3	2398-08	carbide	13.5mm	SØ2mm
6284-4	2381-08	ruby	13.5mm	SØ2mm
6284-8	2399-08	carbide	13.5mm	SØ3mm
6284-21		steel	12.5mm	SØ1mm
6284-22	2380-02	carbide	12.5mm	SØ2mm
6284-24	2381-02	ruby	12.5mm	SØ2mm
6284-23		carbide	12.5mm	SØ3mm
6284-61		steel	13.5mm	SØ1mm
6284-62	2386-16A	carbide	13.5mm	SØ2mm
6284-63	2480-16	ruby	13.5mm	SØ2mm
6284-64		carbide	13.5mm	SØ3mm
6284-81		steel	27.4mm	SØ1mm
6284-82	2383-08A	carbide	27.4mm	SØ2mm
6284-83		ruby	27.4mm	SØ2mm
6284-84		carbide	27.4mm	SØ3mm

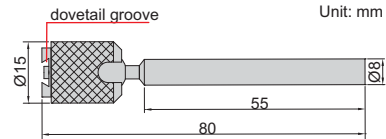
DIAL TEST INDICATOR UNIVERSAL HOLDER



6297-1

- Set the indicators at the desired attitude to the workpiece

Code
6297-1



7

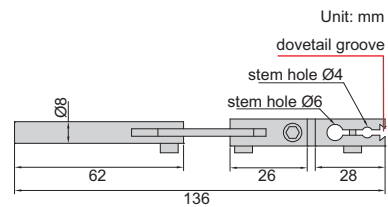
DIAL TEST INDICATOR HOLDER



6296-1

- Supplied with hex key

Code
6296-1



DIAL TEST INDICATOR HOLDERS

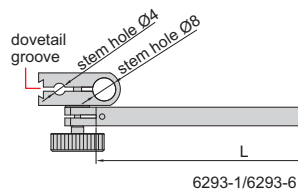


6293-1

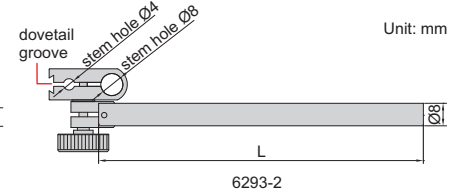


6293-2

Code	Stem section	Stem length (L)
6293-1	9x9mm	100mm
6293-6	9x9mm	50mm
6293-2	Ø8mm	115mm



6293-1/6293-6



6293-2

Unit: mm

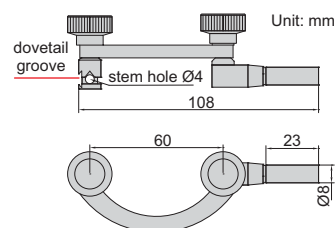
DIAL TEST INDICATOR CENTERING HOLDER



6291-1

- Center cylinders or holes on machine tools

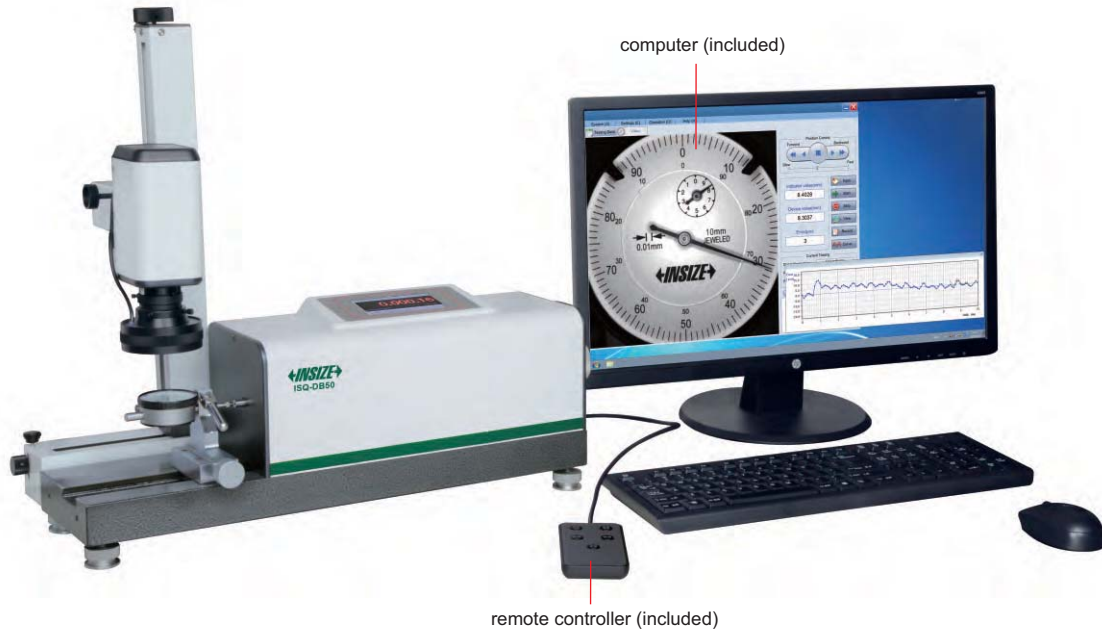
Code
6291-1



Unit: mm



AUTOMATIC DIAL INDICATOR TESTER CODE ISQ-DB50



- Automatic measurement
- Semi-automatic measurement is possible, operate by hand and find graduation lines by eyes, for indicators with stains on dial faces
- Automatic zero setting
- Detection accuracy of graduation lines:
1/15 graduation for 0.001mm dial indicators or dial test indicators,
1/30 graduation for 0.01mm dial indicators or dial test indicators
- Suitable for dial indicators or dial test indicators with plain and convex crystals

SPECIFICATION

Applicable products	dial indicators, digital indicators, dial test indicators and bore gages
Standard	DIN878, DIN2270, ASME B89.1.10M, BS907, BS2795, JIS B7503, JIS B7533 and so on. customized standard: customers can set the range, interval, accuracy and hysteresis
Measuring range	0-50mm
Resolution	0.1μm
Repeatability	0.1μm
Speed	average 0.6s/point (adjustable) It takes 3 minutes to calibrate a 10mm dial indicator (100 points forward and 100 points backward)
Accuracy	any 1mm: 0.8μm
	any 2mm: 1.0μm
	any 10mm: 1.3μm
	any 30mm: 1.5μm
	50mm: 2.0μm
Hysteresis	0.5μm
Output	RS232
Power supply	220V, 50Hz
Operation temperature	20±5°C
Operation humidity	(50~70)%RH
Dimension (L×W×H)	640×240×530mm
Weight	35kg

STANDARD DELIVERY

Main unit	1 pc
Holder for dial indicators and digital indicators (Ø8mm, 3/8")	1 pc
Holder for dial test indicators (Ø4mm, Ø6mm, Ø8mm)	3 pcs
Holder for bore gages (Ø4-28mm)	1 pc
Computer	1 pc
Remote controller	1 pc
Software	1 pc

OPTIONAL ACCESSORY

Holder for split type bore gages	ISQ-DB501
Cable for INSIZE digital indicators	ISQ-DB502

To be continued

Continued from previous page



Ø8mm and 3/8" holder for dial indicators or digital indicators (included)



Ø4-28mm holder for bore gages (included)



holder for split type bore gages (optional)



Ø4mm, Ø6mm and Ø8mm holder for dial test indicators (included)



cable for INSIZE digital indicators (optional)



check dial indicators



check dial test indicators



check digital indicators (detect digits on screen)



check INSIZE digital indicators (connection with cable)



check bore gages

report

Dial Indicator Calibration Data Sheet

Measuring Range (Ø/mm)	Resolution (Ø/mm)	Inspection Date	Measuring Date
0-10	0.01	2020-08-27	2020-08-27
0-25	0.01	2020-08-26	2020-08-26
0-50	0.01	2020-08-26	2020-08-26
0-75	0.01	2020-08-26	2020-08-26
0-100	0.01	2020-08-26	2020-08-26

Dial Indicator Calibration Certificate

table form

graph form

Calibration certificate

Serial No.: 1001 Inspection Date: 2020-08-27 Measuring Date: 2020-08-27

Measuring Range: 0-100mm Resolution: 0.01mm

Inspection Result: Pass

certificate form

customized standard

Verification Setting

Work Range

Work Range 1: 0 - 3 mm Inspection Interval 1: 0.1 mm

Work Range 2: - - mm Inspection Interval 2: - mm

Work Range 3: - - mm Inspection Interval 3: - mm

Forward Distance from the last test point: 0.1 mm

Error Item

- Any 0.1mm error Tolerance: 5 µm
- Any 1mm error Tolerance: 10 µm
- The measuring range Tolerance: 14 µm
- Hysteresis Error Tolerance: 3 µm
- Repeatability Tolerance: 3 µm
- / Tolerance: µm
- / Tolerance: µm

Repeatability

Position Number: 3

Testing times: 5

Testing position: 0.0 0.5 1.0 Range proportion

Movement distance: -10 Div

Additional test

Maximum Error Point Additional test range: ± 0.1 mm

Inspection Interval: 0.01 mm

OK Cancel

DIAL INDICATOR TESTER CODE 2396-25A

- To calibrate dial indicators, test indicators and dial bore gages
- Dimension: 270x210x205mm
- Weight: 11kg

Micrometer head

Range	Sampling interval	Accuracy	Hysteresis
0-25mm	0.1mm	4µm (0-25mm), 3µm (0-10mm), 2µm (0-1mm)	1µm

Force gage

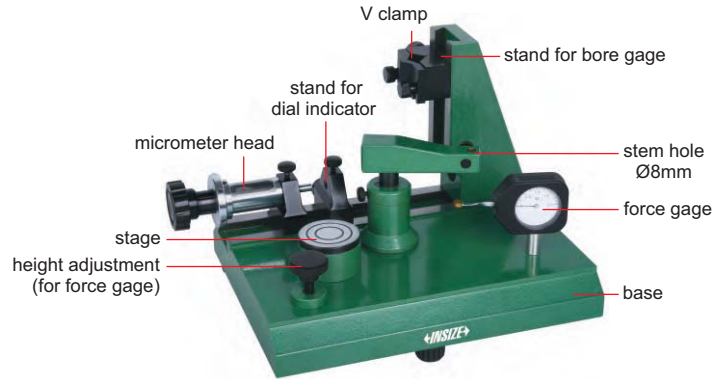
Range	Graduation	Accuracy
0-1.6N	0.05N	±5% (of load capacity)

Stage

Diameter	Flatness	Roughness
50mm	1µm	0.05µm



ATTENTION: NOT SUITABLE FOR DIAL INDICATORS WITH GRADUATION 0.001MM



2396-25A

7



Half round gage block (optional)

Code	Parallelism
2396-block	1µm



UNIVERSAL MAGNETIC STAND (ECONOMIC TYPE)

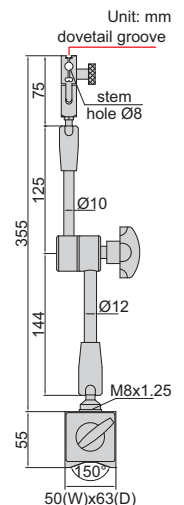
ATTENTION: LOW LOCKING FORCE

- For digital/dial indicators and dial test indicators

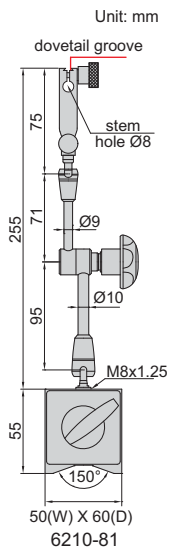
Code	Magnetic force	Applicable holding stem	Remark
6208-80A	80kgf	Ø8mm	with fine adjustment and dovetail groove



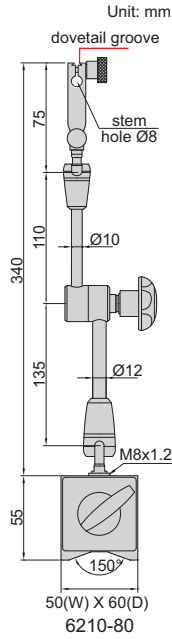
6208-80A



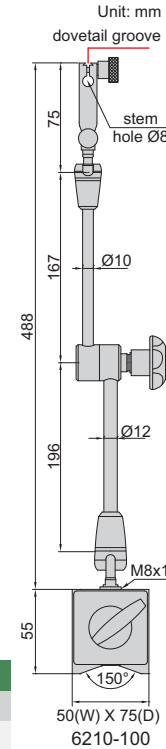
UNIVERSAL MAGNETIC STANDS



6210-81



6210-80



6210-100

■ For digital/dial indicators and dial test indicators

Code	Magnetic force	Applicable holding stem	Remark
6210-81	80kgf	Ø8mm	with fine adjustment and dovetail groove
6210-80	80kgf	Ø8mm	with fine adjustment and dovetail groove
6210-100	100kgf	Ø8mm	with fine adjustment and dovetail groove

MAGNETIC STANDS



6200-60



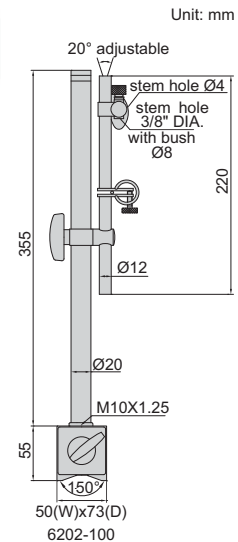
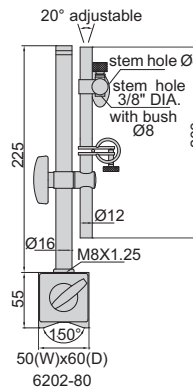
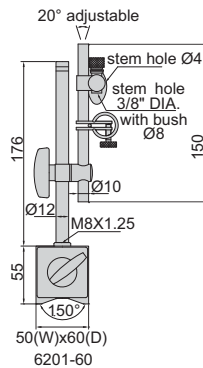
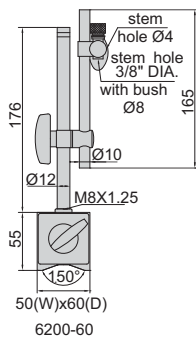
6201-60



6202-80



6202-100



■ For digital/dial indicators and dial test indicators

Code	Magnetic force	Applicable holding stem	Remark
6200-60	60kgf	Ø8mm, Ø4mm, 3/8" DIA.	without fine adjustment
6201-60	60kgf	Ø8mm, Ø4mm, 3/8" DIA.	with fine adjustment
6202-80	80kgf	Ø8mm, Ø4mm, 3/8" DIA.	with fine adjustment
6202-100	100kgf	Ø8mm, Ø4mm, 3/8" DIA.	with fine adjustment

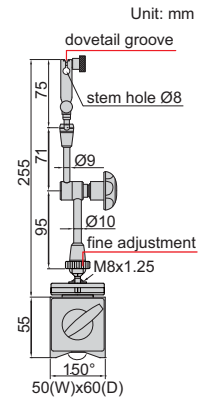
MAGNETIC STAND WITH TWO FINE ADJUSTMENTS

- With two fine adjustments on the head and on the base
- For digital/dial indicators and dial test indicators

Code	Magnetic force	Applicable holding stem	Remark
6272-80	80kgf	Ø8mm	with two fine adjustments and dovetail groove



6272-80



7

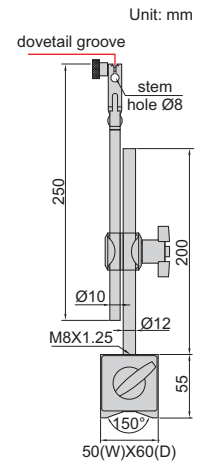
MAGNETIC STAND

- For digital/dial indicators and dial test indicators

Code	Magnetic force	Applicable holding stem	Remark
6216-80	80kgf	Ø8mm	with fine adjustment and dovetail groove

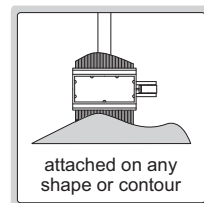


6216-80

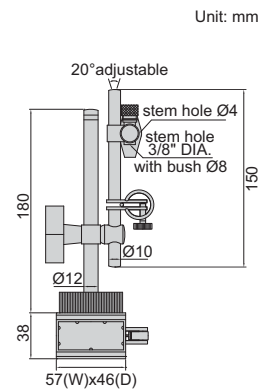


MAGNETIC STAND FOR UNEVEN SURFACE

- For digital/dial indicators and dial test indicators
- With fine adjustment



6215-60



Code	Magnetic force	Applicable holding stem
6215-60	60kgf	Ø8mm, Ø4mm, 3/8" DIA.

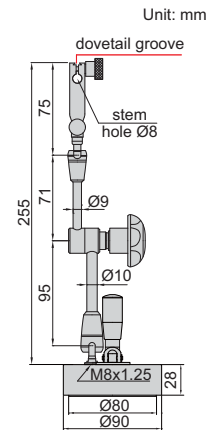
VACUUM STAND

- Suitable for granite surface plates or cast iron surface plates
- For digital/dial indicators and dial test indicators

Code	Diameter of vacuum disc	Vacuum force	Applicable holding stem	Remark
6217-B	Ø80mm	80kgf	Ø8mm	with fine adjustment and dovetail groove



6217-B



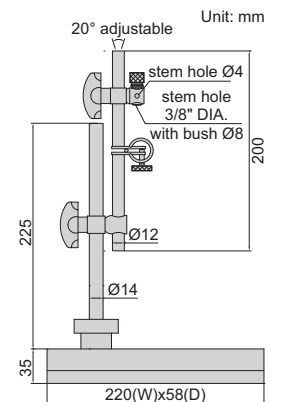
UNIVERSAL STAND

- For digital/dial indicators and dial test indicators
- With fine adjustment

Code	Applicable holding stem
6214-A	Ø8mm, Ø4mm, 3/8" DIA.



6214-A



ATTENTION: FOR DIAL TEST INDICATORS ONLY

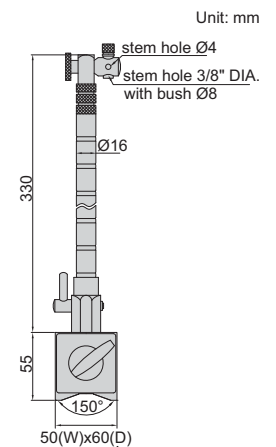
FLEX ARM MAGNETIC STAND

- For dial test indicators

Code	Magnetic force	Applicable holding stem
6207-80A	80kgf	Ø8mm, Ø4mm, 3/8" DIA.



6207-80A



MINI MAGNETIC STAND

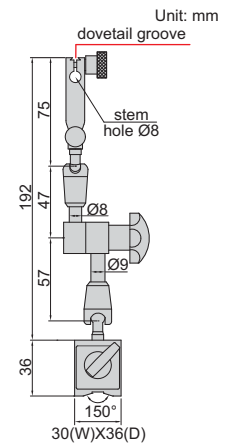
ATTENTION: FOR DIAL TEST INDICATORS ONLY

- For dial test indicators
- With fine adjustment and dovetail groove

Code	Magnetic force	Applicable holding stem
6224-40	40kgf	Ø8mm



6224-40



MINI MAGNETIC STAND

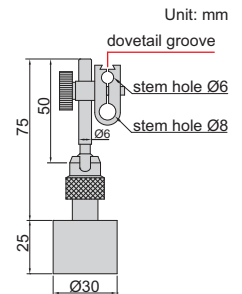
ATTENTION: FOR DIAL TEST INDICATORS ONLY

- For dial test indicators
- With dovetail groove

Code	Magnetic force	Applicable holding stem
6211-10	10kgf	Ø6mm, Ø8mm



6211-10

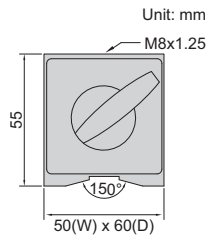


MAGNETIC BASES

Code	Magnetic force
6212-80	80kgf
6212-100	100kgf



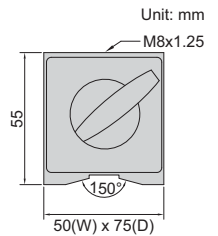
6212-80



6212-80



6212-100



6212-100

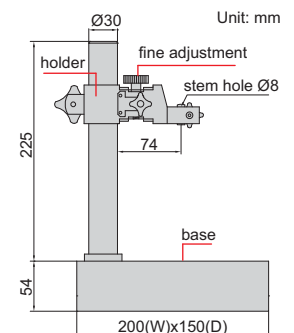
GRANITE DIAL INDICATOR STAND

- Vertical travel of holder: 150mm
- Fine adjustment range: 2mm
- Supplied with dust cover

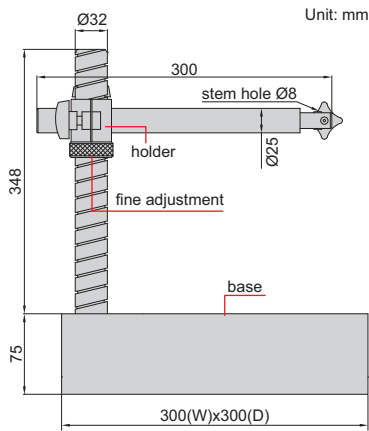
Code	Applicable holding stem	Base
6866-150	Ø8mm	flatness 2.5µm



6866-150



GRANITE DIAL INDICATOR STAND



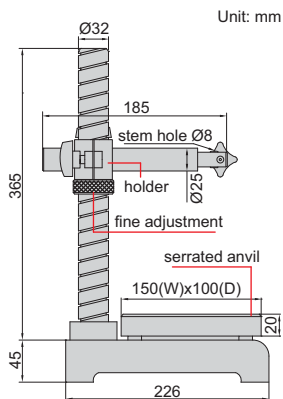
- Vertical travel of holder: 250mm
- Fine adjustment range: entire stroke
- Supplied with dust cover



6867-250

Code	Applicable holding stem	Base
6867-250	Ø8mm	flatness 2.8µm

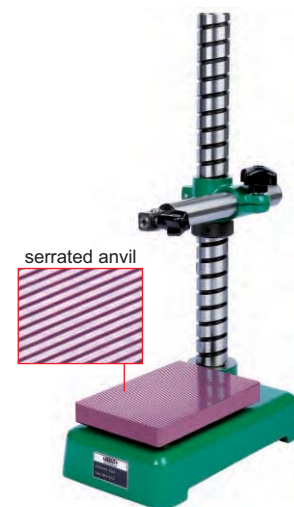
DIAL INDICATOR STANDS



- Vertical travel of holder: 250mm
- Fine adjustment range: entire stroke
- Supplied with dust cover



6864-250



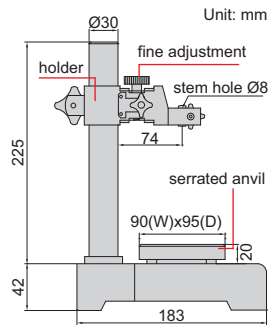
6864-250T

Code	Applicable holding stem	Anvil
6864-250	Ø8mm	steel (hardness HRC60±2), serrated, flatness 1.5µm
6864-250T	Ø8mm	ceramic, serrated, flatness 1.5µm

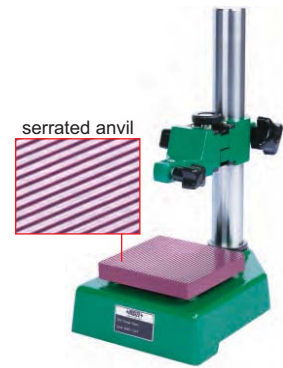
DIAL INDICATOR STANDS

7

- Vertical travel of holder: 150mm
- Fine adjustment range: 2mm
- Supplied with dust cover



6863-150



6863-150T

Code	Applicable holding stem	Anvil
6863-150	Ø8mm	steel (hardness HRC60±2), serrated, flatness 1.5µm
6863-150T	Ø8mm	ceramic, serrated, flatness 1.5µm

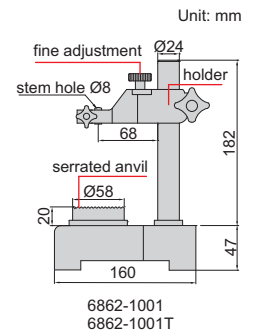
DIAL INDICATOR STANDS



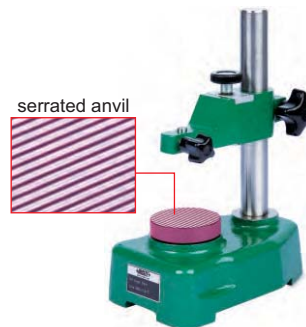
6862-1001



6862-1002



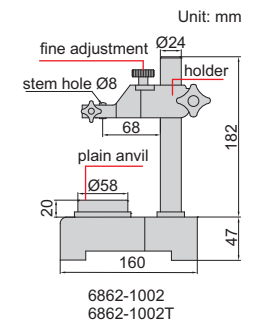
6862-1001
6862-1001T



6862-1001T



6862-1002T



6862-1002
6862-1002T

- Vertical travel of holder: 100mm
- Fine adjustment range: 2mm
- Supplied with dust cover

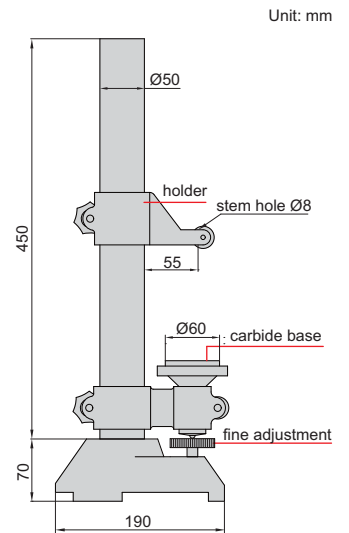
Code	Applicable holding stem	Anvil
6862-1001	Ø8mm	steel (hardness HRC60±2), serrated, flatness 1.5µm
6862-1002	Ø8mm	steel (hardness HRC60±2), plain, flatness 1.5µm
6862-1001T	Ø8mm	ceramic, serrated, flatness 1.5µm
6862-1002T	Ø8mm	ceramic, plain, flatness 1.5µm

HEAVY DUTY DIAL INDICATOR STAND

- Vertical travel of holder: 300mm
- Fine adjustment range: 5mm
- Carbide base
- Supplied with dust cover
- Optional accessory:
holder with stem hole $\varnothing 28$ (code **6869-D28**)



6869-300



7

Code	Applicable holding stem	Base
6869-300	$\varnothing 8$ mm	plain, flatness $1\mu\text{m}$, carbide

TRANSFER STANDS

Application



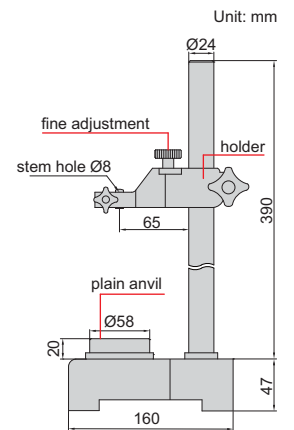
Rigid construction, designed to make comparison height measurement (set zero with gage block then measure height of workpiece) with dial indicators or digital indicators (variation of measuring force is high)



6865-300



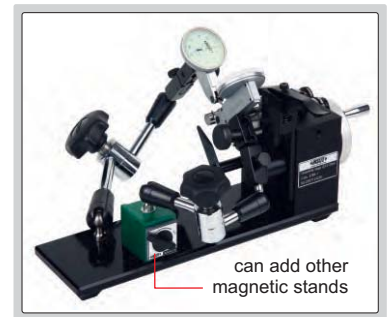
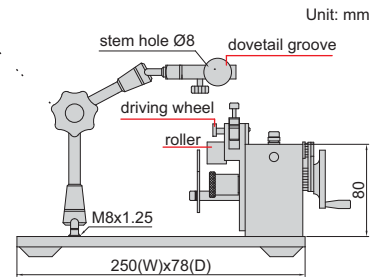
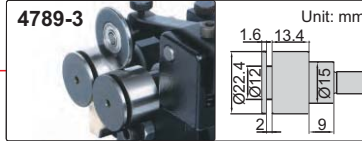
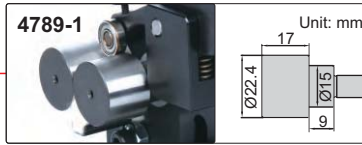
6865-300T



- Vertical travel of holder: 335mm
- Fine adjustment range: 2mm
- Supplied with dust cover

Code	Applicable holding stem	Anvil
6865-300	$\varnothing 8$ mm	steel (hardness HRC60 ± 2), plain, flatness $1.5\mu\text{m}$
6865-300T	$\varnothing 8$ mm	ceramic, plain, flatness $1.5\mu\text{m}$

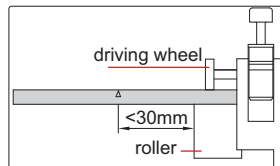
CONCENTRICITY GAGES



- Accuracy 2µm
- Optional accessory: dial test indicator, mini magnetic stand (code 6224-40)

Code	Applicable diameter
4789-1	Ø3.5mm-25mm
4789-2	Ø1mm-25mm
4789-3	Ø1mm-25mm

to ensure the accuracy 2µm, the distance between measuring point and roller should be <30mm



CONCENTRICITY GAGES

HIGH STABILITY,
LONG WORKING LIFE

dial test indicator is optional



4725-45

dial test indicator is optional



4725-60

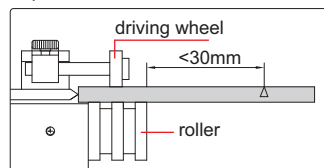
dial test indicator is optional



4725-80

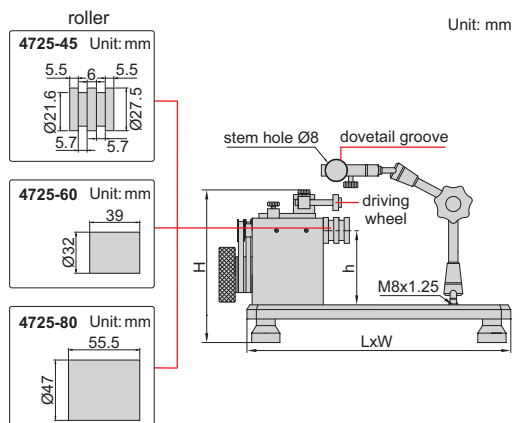


to ensure the accuracy 2µm, the distance between measuring point and roller should be <30mm

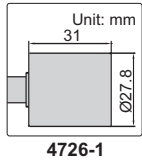


- With ball bearing, high stability, long working life
- Accuracy 2µm
- Optional accessory: dial test indicator

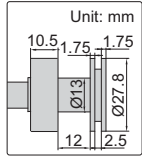
Code	Diameter range	Center height (h)	LxHxW	Weight
4725-45	3-45mm	80mm	280x130x170mm	6kg
4725-60	5-60mm	90mm	350x160x190mm	15.6kg
4725-80	8-80mm	130mm	400x200x250mm	25kg



QUICK-POSITIONING, SUITABLE FOR MASS MEASUREMENT

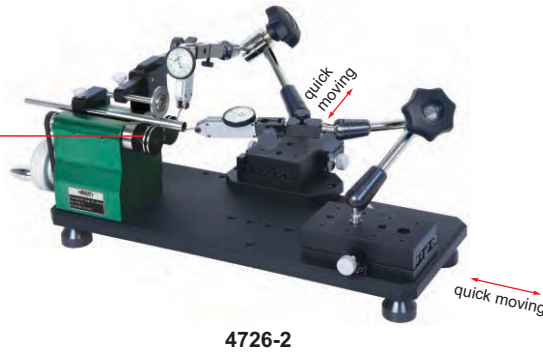


4726-1



4726-2

dial test indicator is optional

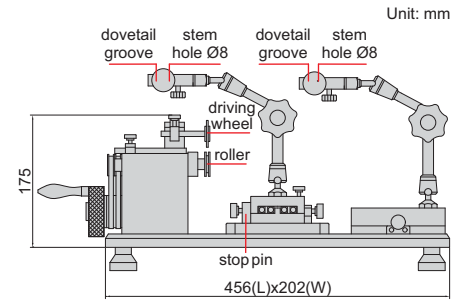


4726-2

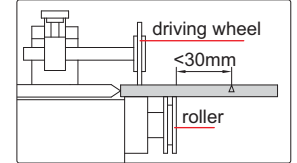
- With ball bearing, high stability, long working life
- Accuracy: 2µm
- Optional accessory: dial test indicator

Code	Applicable diameter
4726-1	Ø3-40mm
4726-2	Ø2-40mm

CONCENTRICITY GAGES



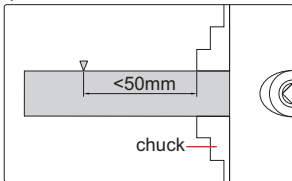
to ensure the accuracy 2µm, the distance between measuring point and roller should be <30mm



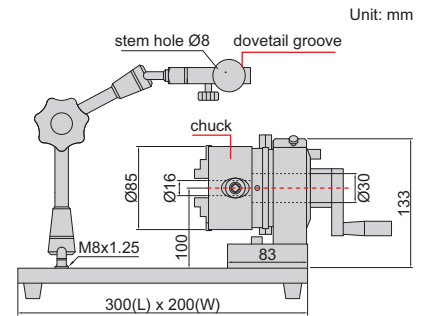
7

CONCENTRICITY GAGE

to ensure the accuracy 8µm, the distance between measuring point and roller should be <50mm



4786-1



for cylinder



for tube



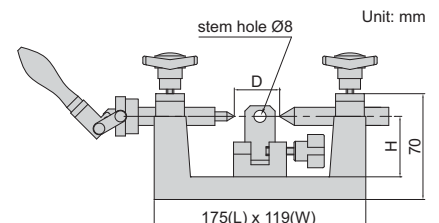
- Accuracy: 8µm
- Optional accessory: dial test indicator

Code	Applicable inside diameter	Applicable outside diameter
4786-1	Ø24-64mm	Ø2-70mm

MINI BENCH CENTER

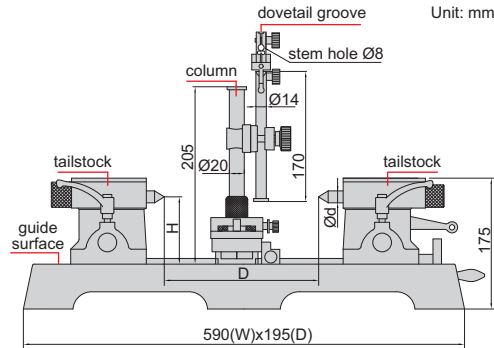
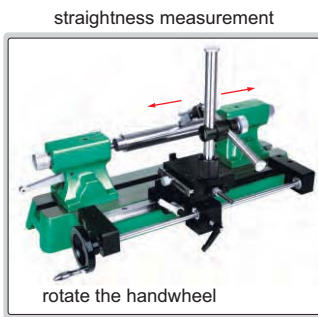


4721-75A



Code	Runout accuracy	Center height (H)	Distance between two centers (D)	Diameter of center (Ød)	Taper of center	Weight	Load
4721-75A	2µm	40mm	35-100mm	6mm	MT1	4.5kg	4kg

BENCH CENTER WITH STRAIGHTNESS MEASUREMENT



4723-300

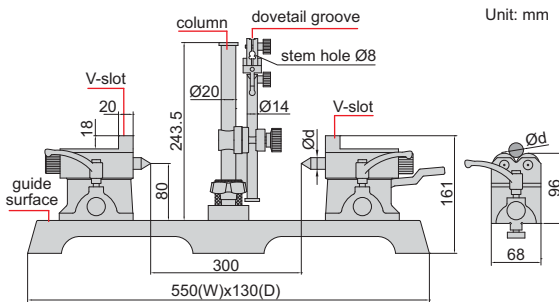
7

- Hardened cast-iron guide surface

Code	Parallelism*	Runout accuracy	Accuracy of straightness measurement	Center height (H)	Distance between two centers (D)	Diameter of center (Ød)	Taper of center	Weight	Load
4723-300	4µm	2µm	0.02mm	90mm	300mm	18mm	MT2	38kg	25kg

*Parallelism of two centers to the guide surface

BENCH CENTER WITH ROLLER TAILSTOCKS



roller tailstocks (included)



- Hardened cast-iron guide surface
- Supplied with V-slot/center tailstocks and roller tailstocks
- V-slot for cylinder Ø4~22mm
- Roller for cylinder Ø5~100mm

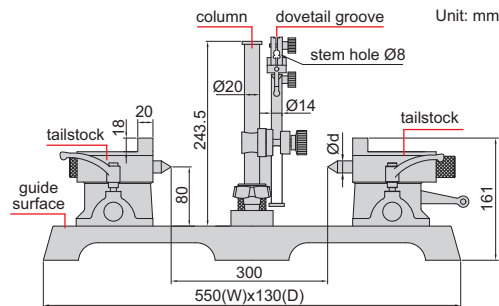
4720-300

Code	Parallelism*	Runout accuracy	Center height	Distance between two centers	Diameter of center (Ød)	Taper of center	Load
4720-300	0.01mm	2µm	80mm	300mm	16mm	MT1	25kg (40kg for roller tailstocks)

*Parallelism of two centers to the guide surface

BENCH CENTER

- Hardened cast-iron guide surface
- Movable column
- V-slot for cylinder Ø4~Ø22mm



4782-300

Code	Parallelism*	Runout accuracy	Center height	Distance between two centers	Taper of center	Diameter of center (Ød)	Load
4782-300	0.01mm	2µm	80mm	300mm	MT1	Ø16mm	25kg

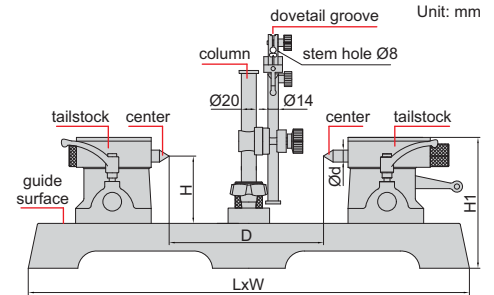
*Parallelism of two centers to the guide surface

BENCH CENTERS

- Movable column
- Optional accessory: umbrella centers, rotary centers



4788-300



High accuracy

(mm)

Code	Parallelism*	Runout accuracy	Center height (H)	Distance between two centers(D)	L	W	H1	Diameter of center (Ød)	Taper of center	Weight	Load
4788-300	0.010mm	2µm	90	300	590	192	175	18.0	MT2	34kg	25kg
4788-400	0.010mm	2µm	130	400	770	206	241	24.1	MT3	66kg	60kg
4788-600	0.010mm	2µm	130	600	930	220	250	24.1	MT3	90kg	60kg
4788-600H2	0.010mm	2µm	200	600	930	220	325	24.1	MT3	105kg	60kg
4788-1000	0.010mm	3µm	130	1000	1330	220	262	24.1	MT3	112kg	60kg
4788-1000H2	0.010mm	3µm	200	1000	1330	220	337	24.1	MT3	125kg	85kg
4788-1000H3	0.010mm	3µm	300	1000	1330	220	442	31.6	MT4	165kg	85kg

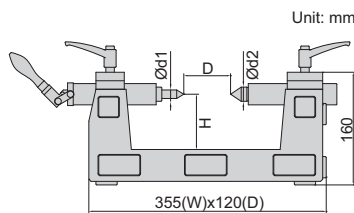
Low accuracy

(mm)

Code	Parallelism*	Runout accuracy	Center height (H)	Distance between two centers(D)	L	W	H1	Diameter of center (Ød)	Taper of center	Weight	Load
4788-D2	0.010mm	3µm	90	200	490	180	175	20.0	MT2	27kg	25kg
4788-D3	0.010mm	3µm	90	300	590	195	175	20.0	MT2	36kg	25kg
4788-D4	0.012mm	3µm	130	400	730	205	241	28.0	MT3	68kg	60kg
4788-D6	0.015mm	3µm	130	600	930	220	250	28.0	MT3	91kg	60kg
4788-D8	0.015mm	3µm	130	800	1130	220	250	28.0	MT3	99kg	60kg
4788-D10	0.015mm	3µm	130	1000	1330	220	262	28.0	MT3	116kg	60kg

*Parallelism of two centers to the guide surface

VERTICAL AND HORIZONTAL BENCH CENTER



- For vertical, side and horizontal use



horizontal use



side use

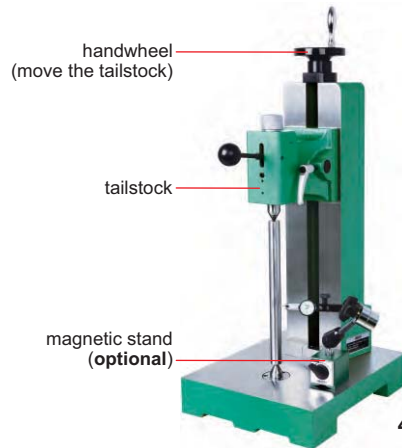


vertical use

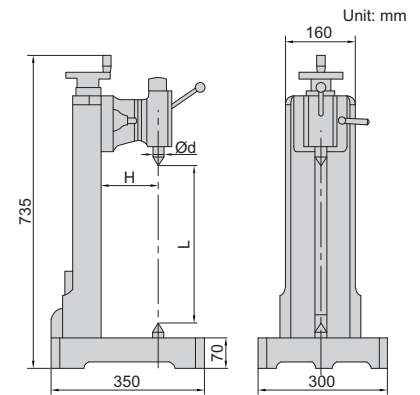
Code	Runout accuracy	Center height (H)	Distance between two centers (D)	Diameter of center (Ød1/Ød2)	Taper of center	Weight	Load
4722-200	2µm	80mm	200mm	12mm/20.2mm	MT1/MT3	22kg	25kg

VERTICAL BENCH CENTER

- Distance between two centers (L): 360mm
- Hardened cast-iron guide surface
- Use handwheel to move the tailstock
- Optional accessory: magnetic stands, dial test indicators



4728-360

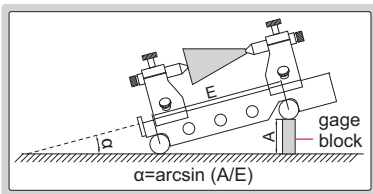


Code	Parallelism*	Runout accuracy	Center height (H)	Diameter of center (Ød)	Taper of center	Weight	Load
4728-360	0.01mm	2µm	130mm	24.1mm	MT3	85kg	80kg

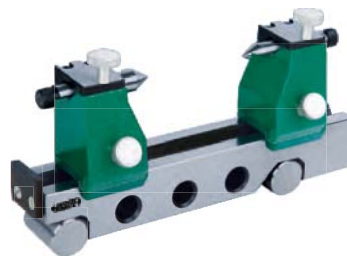
*Parallelism of two centers to the guide surface

TAPER INSPECTION INSTRUMENT

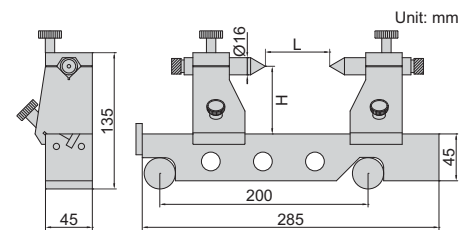
CAN BE CUSTOMIZED



- Check the taper angle of taper bar/ taper plug gages/Morse taper/ISO taper etc. The run out can be checked as well
- Sine bar accuracy (when $\alpha=30^\circ$): ± 5 seconds



4157-200



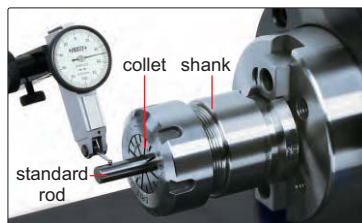
Code	Center height (H)	Center distance (L)
4157-200	65mm	200mm

SHANK RUNOUT TESTERS

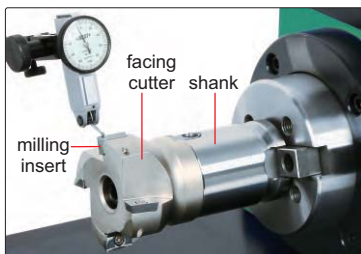
measure radial runout of shank



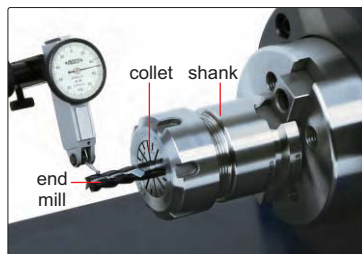
measure radial runout of collet



measure radial runout of cutter



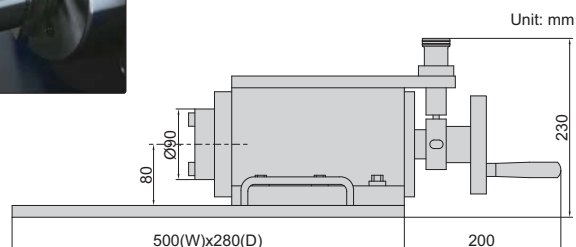
measure radial runout of end mill



4771-30

- Accuracy: 1µm
- Measure the radial runout of shanks, collets and cutting tools
- Optional accessory: dial test indicators, magnetic stands

Code	Taper
4771-30	BT30
4771-40	BT40
4771-50	BT50

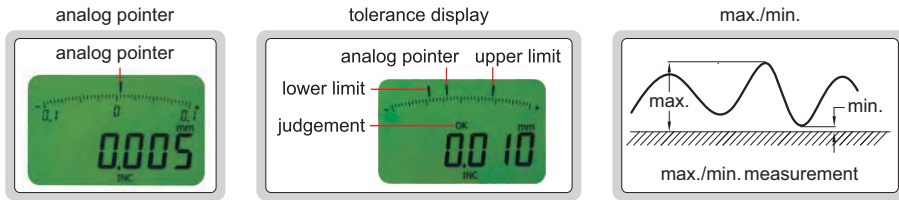


standard shank (included)

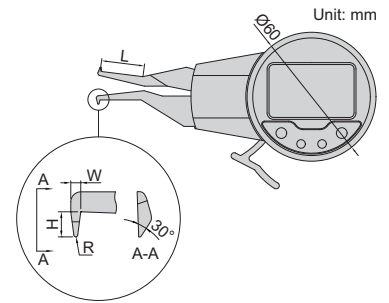


DIGITAL INTERNAL CALIPER GAGES

- Resolution: 0.005mm/0.0002"
- Reading in digit and analog
- Display can be rotated by 170°
- Button function: tolerance Go and No-Go display, data preset, max./min. measurement, data holding, inch/metric conversion, absolute/incremental measurement
- CR2032 battery, automatic power off
- Data output



2121-15



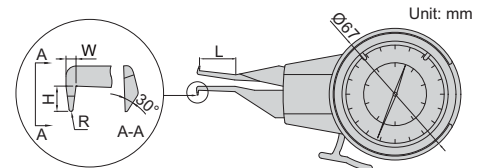
Code	Range	Accuracy	Repeatability	L	H	W	R
2121-15	5-15mm/0.2-0.6"	±0.03mm	0.01mm	20	2	1.5	R0.3
2121-25	5-25mm/0.2-1.0"	±0.03mm	0.01mm	35	1.5	1.0	R0.3
2121-31	10-30mm/0.4-1.2"	±0.03mm	0.01mm	55	5.5	2.5	R0.5
2121-41	20-40mm/0.8-1.6"	±0.03mm	0.01mm	80	6.0	3.0	R0.5
2121-51	30-50mm/1.2-2.0"	±0.03mm	0.01mm	80	8.0	3.0	R0.5
2121-61	40-60mm/1.6-2.4"	±0.03mm	0.01mm	80	8.0	3.0	R0.5

INTERNAL DIAL CALIPER GAGES

Code	Range	Graduation	Accuracy	L	H	W	R
2222-15	5-15mm	0.01mm	±0.03mm	20	2	1.5	R0.3
2222-25	5-25mm	0.01mm	±0.03mm	35	1.5	1.0	R0.3
2222-301	10-30mm	0.01mm	±0.03mm	55	5.5	2.5	R0.5
2222-401	20-40mm	0.01mm	±0.03mm	80	6.0	3.0	R0.5
2222-501	30-50mm	0.01mm	±0.03mm	80	8.0	3.0	R0.5
2222-60	40-60mm	0.01mm	±0.03mm	80	8.0	3.0	R0.5

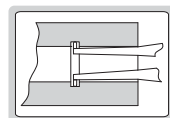


2222-15



INTERNAL DIAL CALIPER GAGES

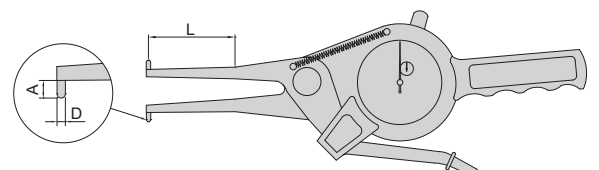
- Carbide measuring tips



Code	Range	Graduation	Accuracy	L	A	D
2321-35	15-35mm	0.01mm	±0.04mm	50	3	Ø3
2321-AL35	15-35mm	0.01mm	±0.04mm	200	3	Ø3
2321-55	35-55mm	0.01mm	±0.04mm	80	6	Ø3
2321-AL55	35-55mm	0.01mm	±0.04mm	250	8	Ø3
2321-75	55-75mm	0.01mm	±0.04mm	90	8	Ø3
2321-AL75	55-75mm	0.01mm	±0.04mm	250	8	Ø3
2321-95	75-95mm	0.01mm	±0.04mm	100	8	Ø3
2321-115	95-115mm	0.01mm	±0.04mm	120	10	Ø3.2
2321-135	115-135mm	0.01mm	±0.04mm	120	10	Ø3.2



2321-35



DIGITAL INTERNAL CALIPER GAGES

DATA OUTPUT

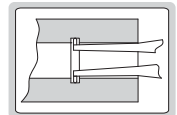
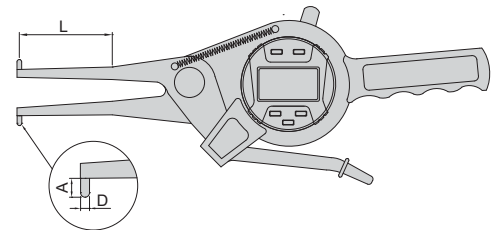
- Carbide measuring tips
- Reading in digit and analog
- Display can be rotated by 320°
- Button function: tolerance Go and No-Go display, data preset, measuring direction change, max./min./TIR measurement, inch/metric conversion, absolute/incremental measurement
- CR2032 battery, automatic power off
- Data output
- Optional accessory: data output cable (code 7315-50M, 7302-50M)



2151-35

Code	Range	Resolution	Accuracy	L	A	D
2151-35	15-35mm/0.6-1.4"	0.01mm/0.0005"	±0.04mm	50	3	∅3
2151-AL35	15-35mm/0.6-1.4"	0.01mm/0.0005"	±0.04mm	200	3	∅3
2151-55	35-55mm/1.4-2.2"	0.01mm/0.0005"	±0.04mm	80	6	∅3
2151-AL55	35-55mm/1.4-2.2"	0.01mm/0.0005"	±0.04mm	250	8	∅3
2151-75	55-75mm/2.2-3"	0.01mm/0.0005"	±0.04mm	90	8	∅3
2151-AL75	55-75mm/2.2-3"	0.01mm/0.0005"	±0.04mm	250	8	∅3
2151-95	75-95mm/3-3.8"	0.01mm/0.0005"	±0.04mm	100	8	∅3.2
2151-115	95-115mm/3.8-4.6"	0.01mm/0.0005"	±0.04mm	120	10	∅3.2
2151-135	115-135mm/4.6-5.4"	0.01mm/0.0005"	±0.04mm	120	10	∅3.2

(mm)



8

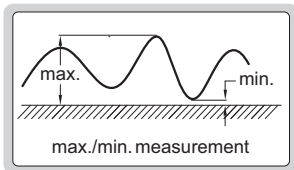
DIGITAL EXTERNAL CALIPER GAGES

- Resolution: 0.005mm/0.0002"
- Reading in digit and analog
- Display can be rotated by 170°
- Button function: tolerance Go and No-Go display, data preset, max./min. measurement, data holding, inch/metric conversion, absolute/incremental measurement
- CR2032 battery, automatic power off
- Data output

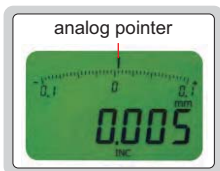


2131-21

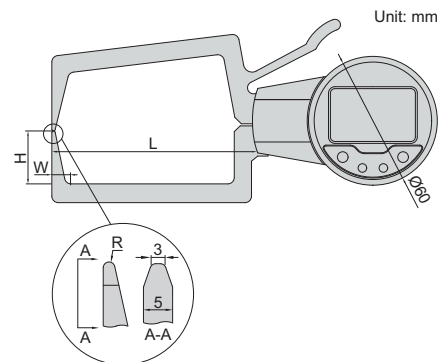
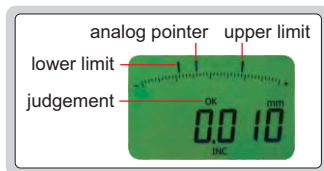
max./min.



analog pointer

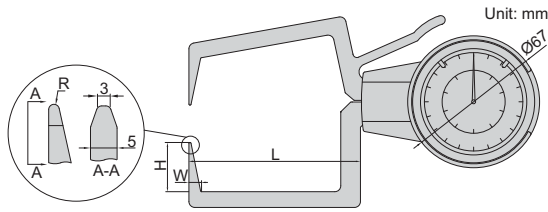


tolerance display



Code	Range	Accuracy	Repeatability	L	H	W	R
2131-21	0-20mm/0-0.8"	±0.03mm	0.01mm	80mm	25mm	6.5mm	R0.5mm
2131-31	10-30mm/0.4-1.2"	±0.03mm	0.01mm	80mm	25mm	6.5mm	R0.5mm
2131-41	20-40mm/0.8-1.6"	±0.03mm	0.01mm	80mm	25mm	6.5mm	R0.5mm
2131-51	30-50mm/1.2-2.0"	±0.03mm	0.01mm	80mm	25mm	6.5mm	R0.5mm
2131-61	40-60mm/1.6-2.4"	±0.03mm	0.01mm	80mm	25mm	6.5mm	R0.5mm

EXTERNAL DIAL CALIPER GAGES



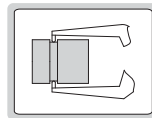
2333-201

Code	Range	Graduation	Accuracy	L	H	W	R
2333-201	0-20mm	0.01mm	±0.03mm	80	25	6.5	R0.5
2333-301	10-30mm	0.01mm	±0.03mm	80	25	6.5	R0.5
2333-401	20-40mm	0.01mm	±0.03mm	80	25	6.5	R0.5
2333-501	30-50mm	0.01mm	±0.03mm	80	25	6.5	R0.5
2333-601	40-60mm	0.01mm	±0.03mm	80	25	6.5	R0.5

(mm)

EXTERNAL DIAL CALIPER GAGES

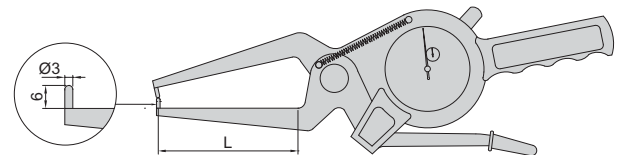
- Carbide measuring tips



2332-20

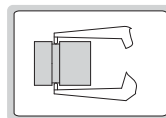
Unit: mm

Code	Range	Graduation	Accuracy	L (mm)
2332-20	0-20mm	0.01mm	±0.04mm	60
2332-40	20-40mm	0.01mm	±0.04mm	60
2332-60	40-60mm	0.01mm	±0.04mm	55
2332-80	60-80mm	0.01mm	±0.04mm	55
2332-100	80-100mm	0.01mm	±0.04mm	55



DATA OUTPUT

- Carbide measuring tips
- Reading in digit and analog
- Display can be rotated by 320°
- Button function: tolerance Go and No-Go display, data preset, measuring direction change, max./min./TIR measurement, inch/metric conversion, absolute/incremental measurement
- CR2032 battery, automatic power off
- Data output
- Optional accessory: data output cable (code 7315-50M, 7302-50M)



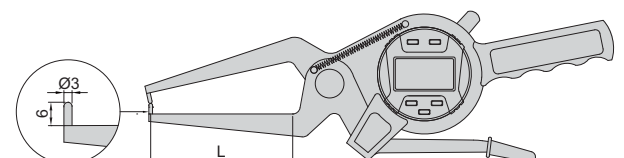
DIGITAL EXTERNAL CALIPER GAGES



2132-20

Unit: mm

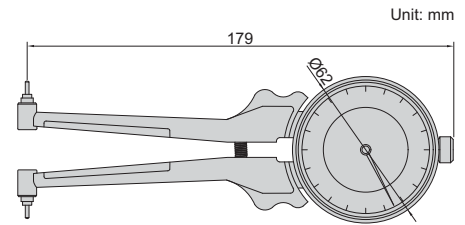
Code	Range	Resolution	Accuracy	L (mm)
2132-20	0-20mm/0-0.8"	0.01mm/0.0005"	±0.04mm	60
2132-40	20-40mm/0.8-1.6"	0.01mm/0.0005"	±0.04mm	60
2132-60	40-60mm/1.6-2.4"	0.01mm/0.0005"	±0.04mm	55
2132-80	60-80mm/2.4-3.2"	0.01mm/0.0005"	±0.04mm	55
2132-100	80-100mm/3.2-4"	0.01mm/0.0005"	±0.04mm	55



INTERNAL DIAL CALIPER GAGE WITH INTERCHANGEABLE POINTS



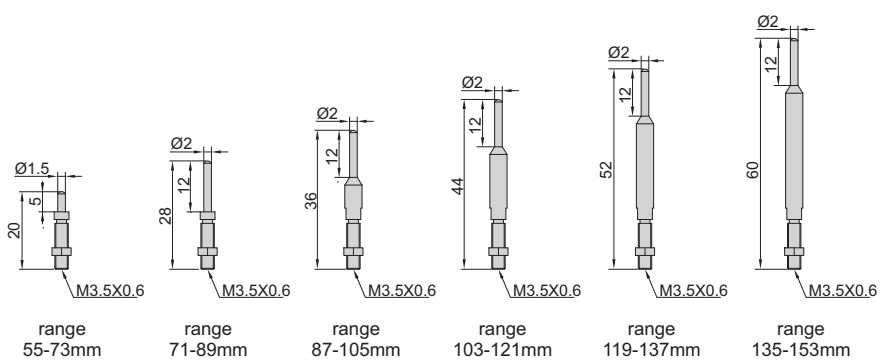
2223-153



Unit: mm

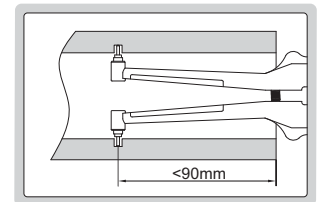
8

6 pair of points (included)



Unit: mm

- Supplied with 6 pairs of points



Code	Range	Dial indicator range	Graduation	Accuracy
2223-153	55-153mm	2mm	0.01mm	±0.02mm

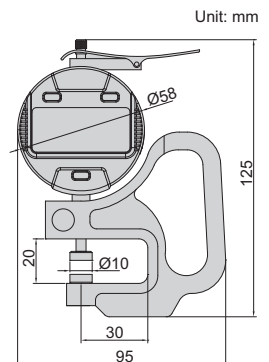
DIGITAL THICKNESS GAGES

DATA OUTPUT

- Ceramic spindle tip and anvil
- Buttons: on/off, zero, mm/inch
- Battery CR2032, automatic power off
- Data output
- Optional accessory: data output cable (code 7315-50M, 7302-50M)



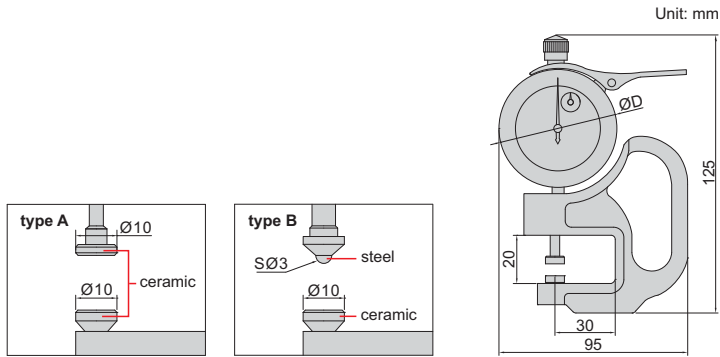
2871-101



Unit: mm

Code	Range	Resolution	Accuracy
2871-10	0-10mm/0-0.4"	0.01mm/0.0005"	±0.02mm
2871-101	0-10mm/0-0.4"	0.001mm/0.00005"	±0.005mm

THICKNESS GAGES



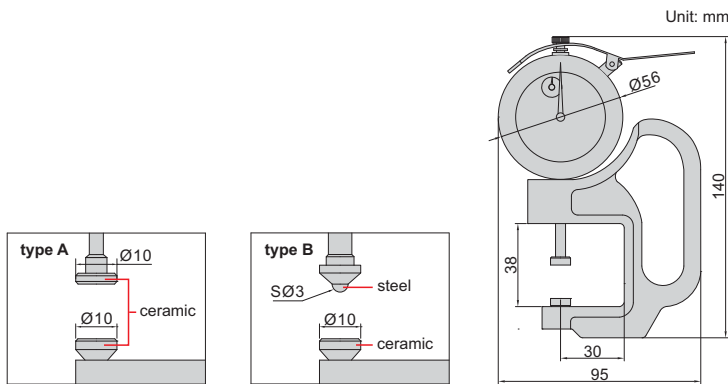
Code	Range	Graduation	Accuracy	Type	ØD
2364-10	0-10mm	0.01mm	±0.02mm	A	58mm
2364-10B	0-10mm	0.01mm	±0.02mm	B	58mm
2364-1	0-1mm	0.001mm	±0.005mm	A	56mm



2364-10

2364-1

THICKNESS GAGES



Code	Range	Graduation	Accuracy	Type
2366-30	0-30mm	0.01mm	±0.035mm	A
2366-30B	0-30mm	0.01mm	±0.035mm	B

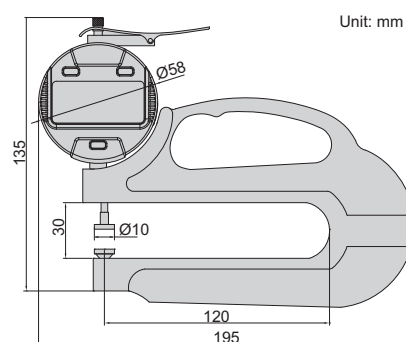


2366-30

DATA OUTPUT

DIGITAL THICKNESS GAGE

measuring tips and anvils can be custom-made

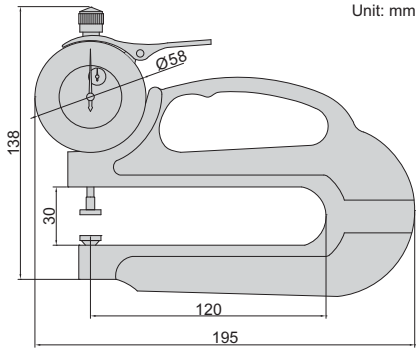
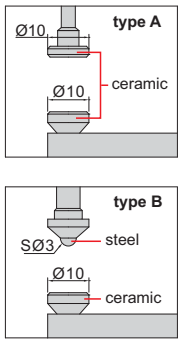


2872-10

- Ceramic spindle tip and anvil
- Buttons: on/off, zero, mm/inch
- Battery CR2032, automatic power off
- Data output
- Optional accessory: data output cable (code 7315-50M, 7302-50M)

Code	Range	Resolution	Accuracy
2872-10	0-10mm/0-0.4"	0.01mm/0.0005"	±0.02mm

THICKNESS GAGES



2365-10

measuring tips
and anvils can
be custom-made



8

Code	Range	Graduation	Accuracy	Type
2365-10	0-10mm	0.01mm	±0.02mm	A
2365-20	0-20mm	0.01mm	±0.03mm	A
2365-10B	0-10mm	0.01mm	±0.02mm	B
2365-20B	0-20mm	0.01mm	±0.03mm	B

DIGITAL ROLLER THICKNESS GAGE

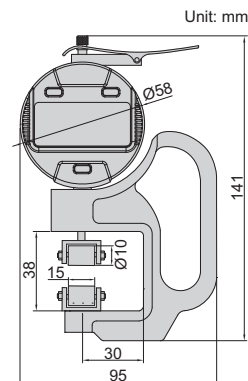
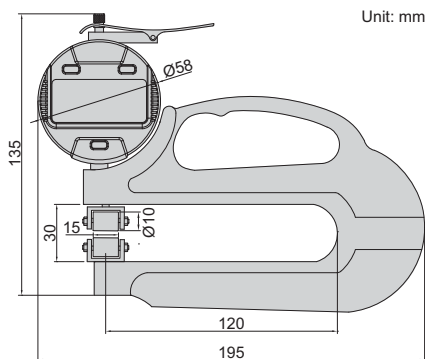
DATA
OUTPUT



2877-4



2877-10



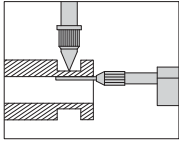
Code	Range	Resolution	Accuracy
2877-4	0-4.5mm/0-0.18"	0.01mm/0.0005"	±0.02mm
2877-10	0-10mm/0-0.4"	0.01mm/0.0005"	±0.02mm

- Buttons: on/off, zero, mm/inch
- Battery CR2032, automatic power off
- Data output
- Optional accessory: data output cable (code 7315-50M, 7302-50M)

DATA OUTPUT

DIGITAL TUBE THICKNESS GAGE

measure wall thickness of grooves

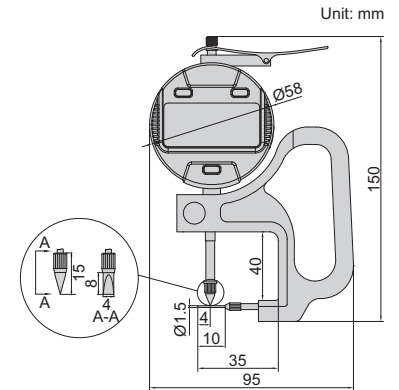


- Buttons: on/off, zero, mm/inch
- Battery CR2032, automatic power off
- Data output
- Optional accessory: data output cable (code 7315-50M, 7302-50M)

Code	Range	Resolution	Accuracy
2873-10	0-10mm/0-0.4"	0.01mm/0.0005"	±0.02mm

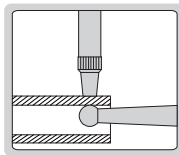


2873-10



DATA OUTPUT

DIGITAL TUBE THICKNESS GAGE

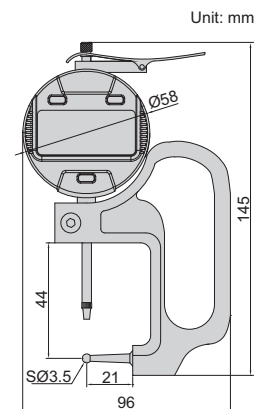


- Buttons: on/off, zero, mm/inch
- Battery CR2032, automatic power off
- Data output
- Optional accessory: data output cable (code 7315-50M, 7302-50M)

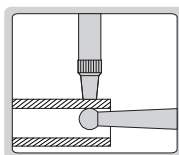
Code	Range	Resolution	Accuracy
2876-10	0-10mm/0-0.4"	0.01mm/0.0005"	±0.02mm



2876-10



TUBE THICKNESS GAGE

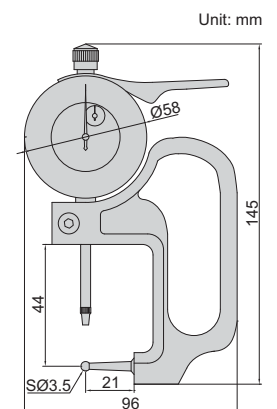


- Measure tube wall thickness

Code	Range	Graduation	Accuracy
2367-10A	0-10mm	0.01mm	±0.02mm

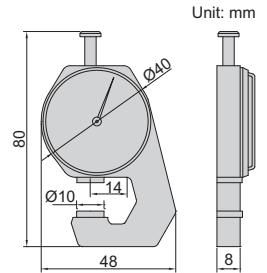
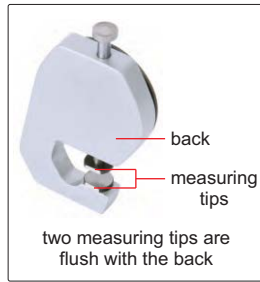
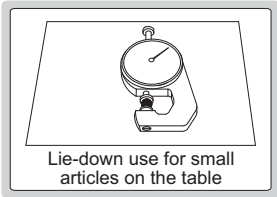


2367-10A



THICKNESS GAGE

SUITABLE FOR JEWELLERY



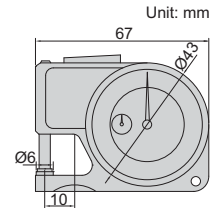
2361-10

Code	Range	Graduation	Accuracy
2361-10	0-10mm	0.1mm	±0.05mm

8

THICKNESS GAGE

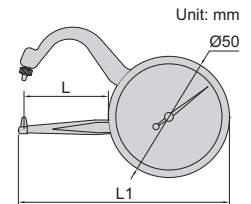
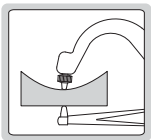
- Stainless steel spindle tip and anvil



2363-10

Code	Range	Graduation	Accuracy
2363-10	0-10mm	0.01mm	±0.03mm

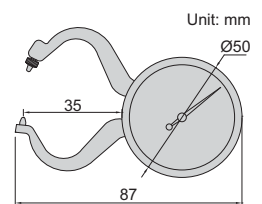
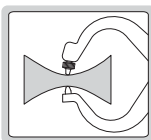
THICKNESS GAGES



2862-101

Code	Range	Graduation	Accuracy	L	L1
2862-101	0-10mm	0.05mm	±0.1mm	35mm	85mm
2862-102	0-10mm	0.05mm	±0.1mm	60mm	110mm

THICKNESS GAGE

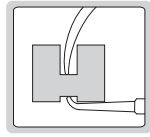


2863-10

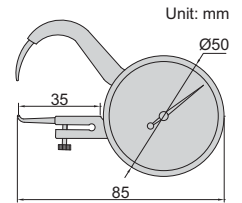
Code	Range	Graduation	Accuracy
2863-10	0-10mm	0.05mm	±0.1mm

THICKNESS GAGE WITH POINTED TIPS

- Pointed tips fit into small grooves and recesses



2866-10



Code	Range	Graduation	Accuracy
2866-10	0-10mm	0.05mm	±0.1mm

IP54
WATERPROOF

DIAL SNAP GAGES

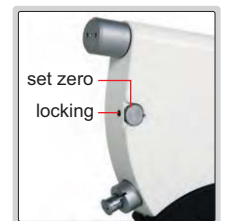
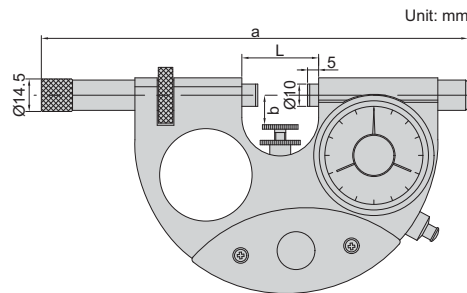
INSIZE PLUS
MADE IN EUROPE

8

- Quick Go/No-Go measurement for mass production
- Anvil retracting stroke: 2.5mm
- Dial indicator: measuring range ±0.07mm, graduation 1µm, accuracy ±1µm
- Constant measuring force over the whole range: 8.5N
- Carbide measuring faces
- IP54 dust/waterproof
- Zero position of dial indicator is adjustable and can be locked (supplied with locking wrench)
- Adjustable platform height



3335-25



Code	Range	L	a	b
3335-25	0-25mm	35mm	191mm	<15mm
3335-50	25-50mm	60mm	215mm	<25mm
3335-75	50-75mm	84mm	239mm	<37.5mm
3335-100	75-100mm	110mm	265mm	<50mm

ATTENTION: NOT SUITABLE FOR 0.001MM DIAL INDICATORS

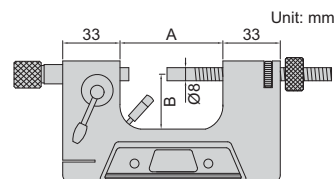
DIAL SNAP GAGES

- Quick measurement for mass production
- Anvil retracting stroke: 3mm
- Measuring force: 6-9N
- Carbide measuring faces
- Optional accessory: dial indicators (graduation 0.01mm), digital indicators (resolution 0.01mm/0.0005")



dial indicator is optional

2184-50W



Code	Range	A	B
2184-25W	0-25mm	34mm	18mm
2184-50W	0-50mm	62mm	32mm
2184-100W	50-100mm	112mm	62mm
2184-150W	100-150mm	162mm	85mm
2184-200W	150-200mm	212mm	110mm

DIAL SNAP GAGES

QUICK AND ACCURATE MEASUREMENT OF CYLINDRICAL WORKPIECES

INSPECTION CERTIFICATE
TRACEABLE TO DKD



- Left anvil retracting stroke: 2mm
- Measuring force: 6-8N
- Flatness of anvil: 1.5µm
- Repeatability: 1µm
- Carbide measuring faces for anvils
- Front edges of anvils are chamfered for easy workpiece insertion
- Optional accessory: dial indicators and digital indicators (reading 0.001mm or 0.01mm)



dial indicator is optional

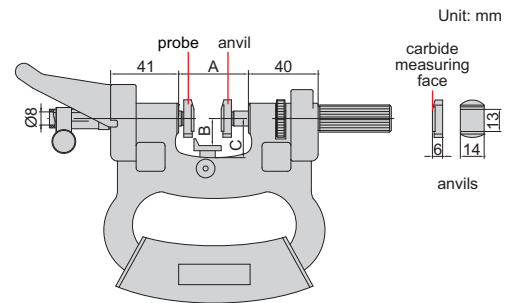
2186-25



application

8

Code	Range	Parallelism of measuring faces	(mm)		
			A	B	C
2186-25 *	0-25mm	4µm	42	11-18	20
2186-50 *	25-50mm	4µm	69	11-32	41
2186-75 *	50-75mm	5µm	94	17-41	51
2186-100 *	75-100mm	6µm	119	31-55	65
2186-125 *	100-125mm	6µm	144	42-70	75
2186-150 *	125-150mm	8µm	169	55-82	90
2186-175 *	150-175mm	8µm	194	68-95	100
2186-200 *	175-200mm	10µm	219	85-110	115
2186-225 *	200-225mm	10µm	244	95-120	130
2186-250 *	225-250mm	10µm	269	110-135	145
2186-275 *	250-275mm	12µm	294	120-150	160
2186-300 *	275-300mm	12µm	319	128-160	170



*Supplied with manufacturer inspection certificate traceable to DKD Germany

DIAL SNAP GAGES (ECONOMIC TYPE)

ATTENTION: SETTING STANDARDS ARE NOT INCLUDED

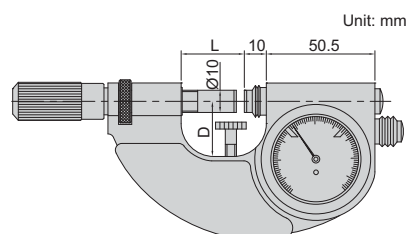
IP54
WATERPROOF

- Quick measurement for mass production
- Dial indicator: range ±0.04mm, graduation 0.001mm, accuracy 0.001mm
- IP54 dust/waterproof
- Measuring force: 5-10N
- Carbide measuring faces
- Optional accessory: gage blocks grade 0 (4101-A series), for zero setting



3334-25

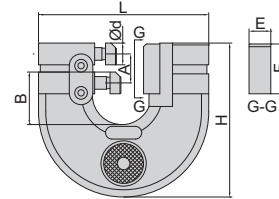
Code	Range	L	D
3334-25	0-25mm	28.5mm	25mm
3334-50	25-50mm	53.5mm	35mm
3334-75	50-75mm	78.5mm	47.5mm
3334-100	75-100mm	103.5mm	60mm



FAST AND ACCURATE MEASUREMENT FOR CYLINDERS

ADJUSTABLE SNAP GAGES

- Used as Go/No-Go gage by setting upper and lower limits
- Flatness of anvil: 1.5µm
- Parallelism of measuring faces:
 - range 0-32mm: 3µm
 - range 32-89mm: 4µm
 - range 89-300mm: 5µm

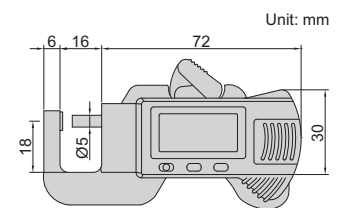


2187-19

(mm)									(mm)								
Code	Range	L	A	B	E	F	H	Ød	Code	Range	L	A	B	E	F	H	Ød
2187-6	0-6mm	74	15	17.5	12.2	27.2	71.5	7	2187-120	114-120mm	210	24	86	15.2	39.2	179	15.3
2187-13	6-13mm	85	15	26	12.2	27.2	79.5	12.3	2187-127	120-127mm	217	24	89.5	15.2	39.2	186	15.3
2187-19	13-19mm	93	15	27	12.2	27.2	83	12.3	2187-133	127-133mm	223	24	92.5	15.2	39.2	192	15.3
2187-25	19-25mm	100	15	33.5	12.2	27.2	89.5	12.3	2187-139	133-139mm	229	24	95.5	15.2	39.2	197	15.3
2187-32	25-32mm	111	18	38.5	15.2	35.2	104	15.3	2187-146	139-146mm	235	24	98.5	15.2	39.2	201	15.3
2187-38	32-38mm	117	18	41.5	15.2	35.2	105	15.3	2187-152	146-152mm	242	24	102	15.2	39.2	205	15.3
2187-44	38-44mm	123	18	44.5	15.2	35.2	109	15.3	2187-163	152-163mm	273	21.4	106.7	18.2	39.2	211	18.3
2187-51	44-51mm	130	18	48	15.2	35.2	117	15.3	2187-175	163-175mm	273	21.4	106.7	18.2	39.2	211	18.3
2187-57	51-57mm	136	18	45	15.2	35.2	119	15.3	2187-188	175-188mm	298.5	21.4	119.7	18.2	39.2	227	18.3
2187-63	57-63mm	143	18	50	15.2	35.2	122	15.3	2187-200	188-200mm	298.5	21.4	119.7	18.2	39.2	227	18.3
2187-70	63-70mm	156	20	58	15.2	35.2	132	15.3	2187-213	200-213mm	324	21.4	131.7	18.2	39.2	242	18.3
2187-76	70-76mm	163	20	60.5	15.2	35.2	137	15.3	2187-225	213-225mm	324	21.4	131.7	18.2	39.2	242	18.3
2187-82	76-82mm	169	20	64.5	15.2	35.2	140	15.3	2187-238	225-238mm	349.5	21.4	144.7	18.2	39.2	250	18.3
2187-89	82-89mm	175	20	66.5	15.2	35.2	146	15.3	2187-250	238-250mm	349.5	21.4	149	18.2	39.2	250	18.3
2187-95	89-95mm	181	20	69.5	15.2	35.2	149	15.3	2187-263	250-263mm	375.5	21.4	157.7	18.2	39.2	278	18.3
2187-101	95-101mm	188	20	70	15.2	35.2	154	15.3	2187-275	263-275mm	375.5	21.4	157.7	18.2	39.2	278	18.3
2187-108	101-108mm	198	24	79	15.2	39.2	166	15.3	2187-288	275-288mm	400	21.4	170.7	18.2	39.2	291	18.3
2187-114	108-114mm	204	24	81	15.2	39.2	172	15.3	2187-300	288-300mm	400	21.4	170.7	18.2	39.2	291	18.3

ATTENTION: NO DATA OUTPUT

DIGITAL SNAP GAGE

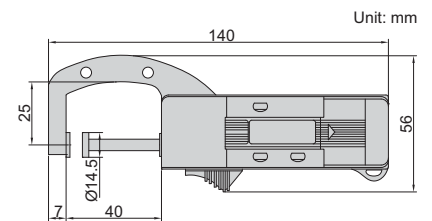


2166-12

Code	Range	Resolution	Accuracy
2166-12	0-12mm/0-0.5"	0.01mm/0.0005"	±0.03mm

ATTENTION: NO DATA OUTPUT

DIGITAL SNAP GAGE



2167-25

Code	Range	Resolution	Accuracy
2167-25	0-25mm/0-1"	0.01mm/0.0005"	±0.03mm

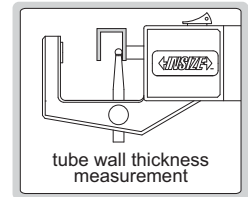
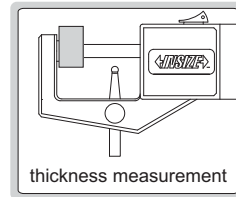
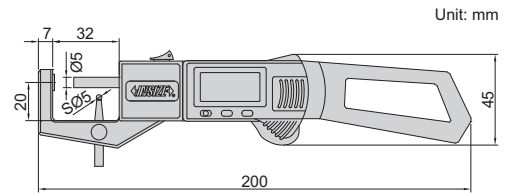
DIGITAL SNAP GAGE

ATTENTION: NO DATA OUTPUT



2163-25

- Resolution: 0.01mm/0.0005"
- Accuracy: ± 0.04 mm
- For thickness and tube wall thickness measurement



Code	Thickness range	Tube wall thickness range
2163-25	0-25mm/0-1"	0-2mm/0.08"

8

DIGITAL SNAP GAGES

DATA OUTPUT

- Buttons: on/off, zero, mm/inch
- Automatic power off, move the digital unit to turn on power
- Battery CR2032
- Made of stainless steel



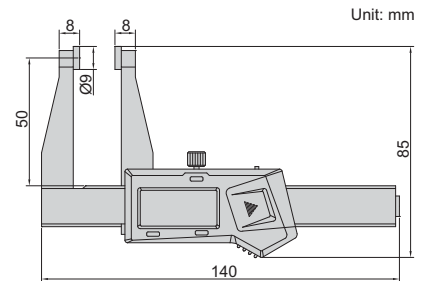
1163-50A

With data interface (data output cable code 7315-21, 7302-21, optional)

Code	Range	Resolution	Accuracy
1163-50A	0-50mm/0-2"	0.01mm/0.0005"	± 0.03 mm

Built-in wireless

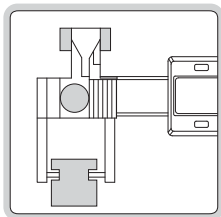
Code	Range	Resolution	Accuracy
1163-50AWL	0-50mm/0-2"	0.01mm/0.0005"	± 0.03 mm



DIGITAL 3-PURPOSE SNAP GAGE

ATTENTION: NO DATA OUTPUT

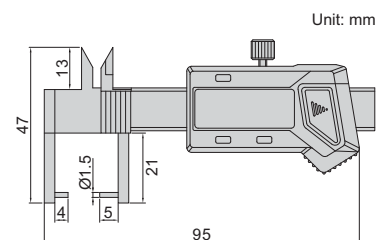
SUITABLE FOR JEWELLERY



2164-25A

- Buttons: zero, mm/inch, on/off
- Battery LR44
- Made of stainless steel

Code	Range	Resolution	Accuracy
2164-25A	0-25mm/0-1"	0.01mm/0.0005"	± 0.03 mm



DATA
OUTPUT

STEP AND GAP GAGES

- Measure step height and gap width
- Resolution: 0.01mm/0.0005"
- Buttons: on/off, set, mm/inch, preset (+, -)
- Automatic power off, move the digital unit to turn on power
- Battery CR2032
- Made of stainless steel
- Supplied with zero setting block



zero setting block
(included)

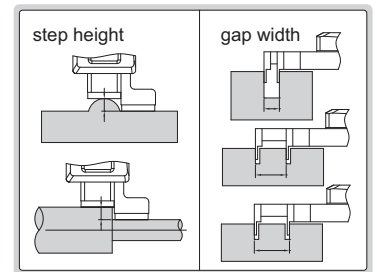
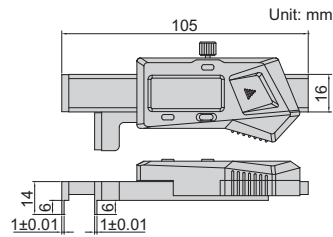


With data interface (data output cable
code 7315-21, 7302-21, optional)

Code	Range	Accuracy
2168-12	0-12.7mm/0-0.5"	±0.03mm

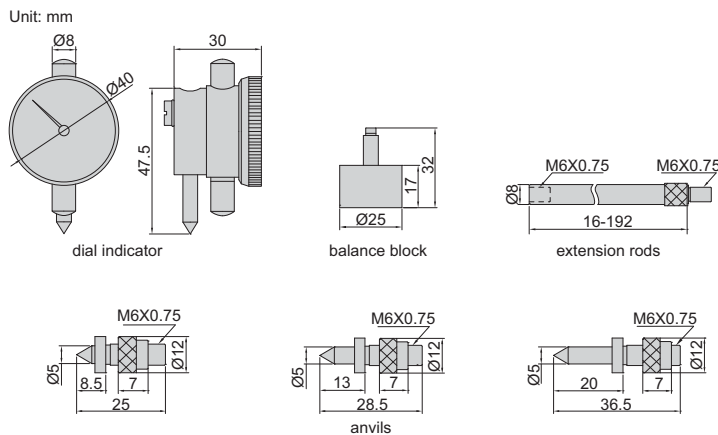
Built-in wireless

Code	Range	Accuracy
2168-12WL	0-12.7mm/0-0.5"	±0.03mm



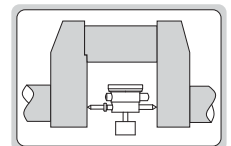
8

CRANKSHAFT TESTERS



2841-500

- To test crankshaft deflection
- The balance block is mounted on the back of dial indicator to keep the dial indicator facing up



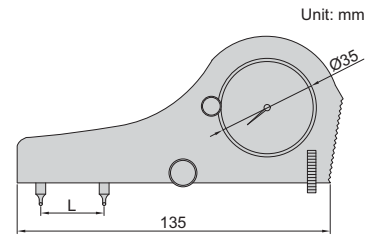
Code	Range	Dial indicator range	Graduation	Extension rods	Accuracy
2841-300	60-300mm	3mm	0.01mm	16mm, 32mm, 64mm, 128mm	±0.016mm
2841-500	60-500mm	3mm	0.01mm	16mm, 32mm, 64mm, 96mm, 128mm, 192mm	±0.016mm

INTERNAL THREAD PITCH MEASURING INSTRUMENTS

MEET INTERNATIONAL STANDARD API5B



2235-4E



application

step 1: set zero on standard block

step 2: measurement



- Measure the pitch of internal thread with nominal diameter larger than 1 1/2" (38.1mm) and less than 5 1/2" (139.7mm)
- Optional accessory: ball points (code 6252 series), standard pitch blocks (code 6251 series)

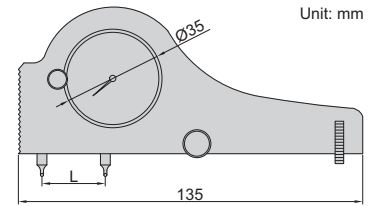
Code	Range (L)	Dial indicator stroke	Dial indicator graduation	Accuracy
2235-4	0.5-4"/12.7-101.6mm	0.5mm	0.01mm	0.02mm
2235-4E	0.5-4"/12.7-101.6mm	0.03"	0.0005"	0.0008"

8

THREAD PITCH MEASURING INSTRUMENTS

MEET INTERNATIONAL STANDARD API5B

2234-4E



application

step 1: set zero on standard block

step 2: measurement



- Measure the pitch of external thread and internal thread with nominal diameter larger than 5 1/2" (139.7mm)
- Optional accessory: ball points (code 6252 series), standard pitch blocks (code 6251 series)

Code	Range (L)	Dial indicator stroke	Dial indicator graduation	Accuracy
2234-4	0.5-4"/12.7-101.6mm	0.5mm	0.01mm	0.02mm
2234-4E	0.5-4"/12.7-101.6mm	0.03"	0.0005"	0.0008"

STANDARD PITCH BLOCKS

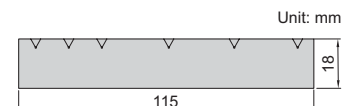
CAN BE CUSTOMIZED ACCORDING TO WORKPIECES

- Set zero of internal and external pitch measuring instruments (code 2234, 2235)

Code	Taper	Threads per inch
6251-S8	1:16	8, 10
6251-S5	1:16	5
6251-S4	1:6	4



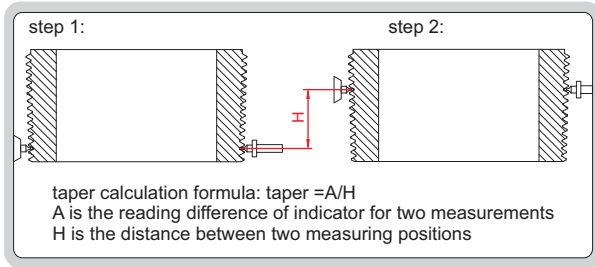
6251-S8



MEET INTERNATIONAL
STANDARD API5B

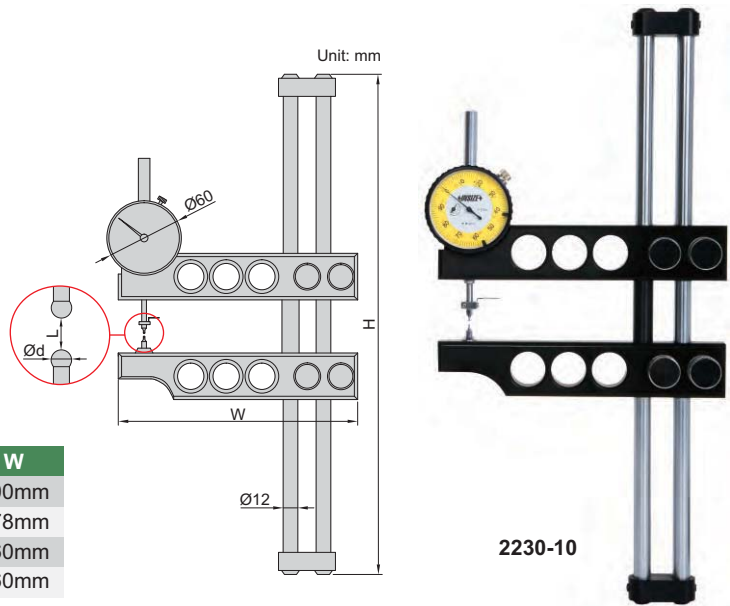
EXTERNAL THREAD TAPER MEASURING INSTRUMENTS

principle of measurement



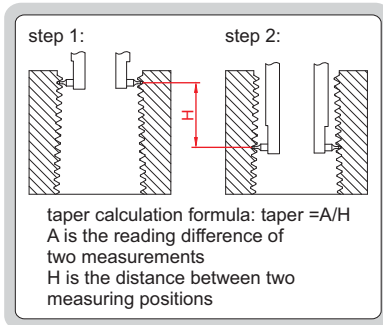
- Measure the taper of external thread
- Dial indicator stroke: 0.5"
- Dial indicator graduation: 0.001"
- Optional accessory: ball points (code 6252 series)

Code	Range (L)	Accuracy	H	W
2230-10	0-10"/0-254mm	0.0015"	400mm	200mm
2230-45	1-4 1/2"/25.4-114.3mm	0.0015"	278mm	178mm
2230-16	8-16"/203.2-406.4mm	0.0015"	600mm	260mm
2230-20	8-20"/203.2-508mm	0.0015"	680mm	260mm



8

principle of measurement

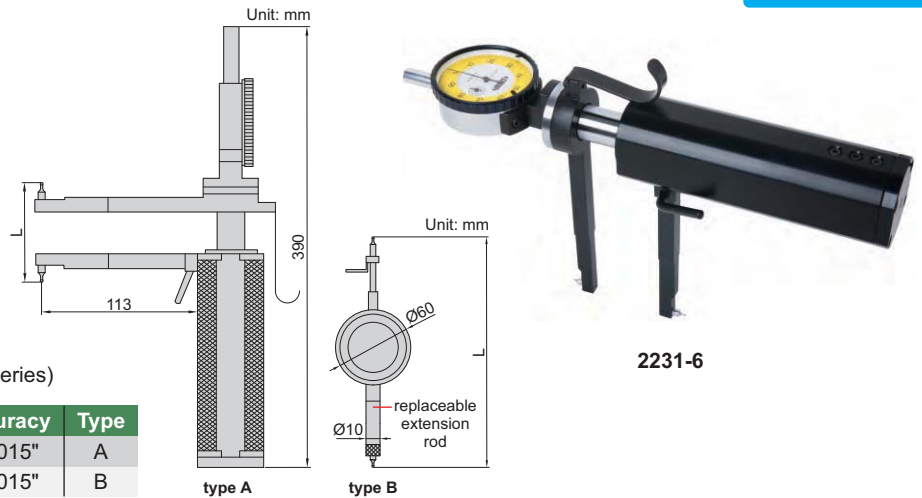


- Measure the taper of internal thread
- Dial indicator stroke: 1"
- Dial indicator graduation: 0.001"
- Optional accessory: ball points (code 6252 series)

Code	Range (L)	Accuracy	Type
2231-6	1-6"/25.4-152.4mm	0.0015"	A
2231-16	5 1/2"-16"/139.7-406.4mm	0.0015"	B

INTERNAL THREAD TAPER MEASURING INSTRUMENTS

MEET INTERNATIONAL
STANDARD API5B



Code	Thread type	Threads per inch	Ball dia. (Ød)	
			Taper	Pitch
6252-B8	round thread, line pipe	8	1.829mm	1.829mm
6252-B10	round thread, line pipe	10	1.448mm	1.448mm
6252-B115	line pipe	11.5	1.27mm	1.27mm
6252-B14	line pipe	14	1.041mm	1.041mm
6252-B18	line pipe	18	0.813mm	0.813mm
6252-B27	line pipe	27	0.533mm	0.533mm
6252-B5	butress thread	5	2.286mm	—
6252-B51	butress thread	5	—	1.575mm
6252-B52	extreme line thread	5,6	1.524mm	—
6252-B53	extreme line thread	5	—	2.667mm*
6252-B6	extreme line thread	6	—	2.210mm*

*0.58mm off the top of ball

BALL POINTS

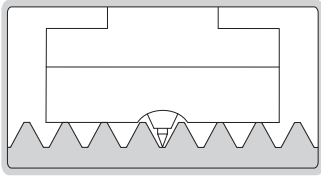


- Supplied in pair
- For taper measuring instruments (code 2230, 2231) and pitch measuring instruments (code 2234, 2235)

THREAD HEIGHT MEASURING INSTRUMENTS

MEET INTERNATIONAL STANDARD API5B

application

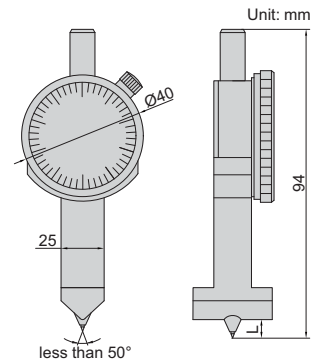


- Measure the height of external thread and internal thread with nominal diameter larger than 5 1/2" (139.7mm)
- Optional accessory: thread height standard blocks (code 6250)

Code	Range (L)	Dial indicator graduation	Accuracy
2232-35	0-3.5mm	0.01mm	0.02mm
2232-35E	0-1/4"	0.0005"	0.0008"



2232-35E

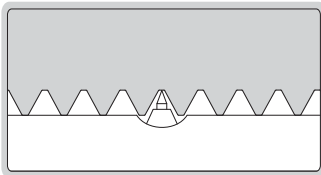


8

INTERNAL THREAD HEIGHT MEASURING INSTRUMENTS

MEET INTERNATIONAL STANDARD API5B

application

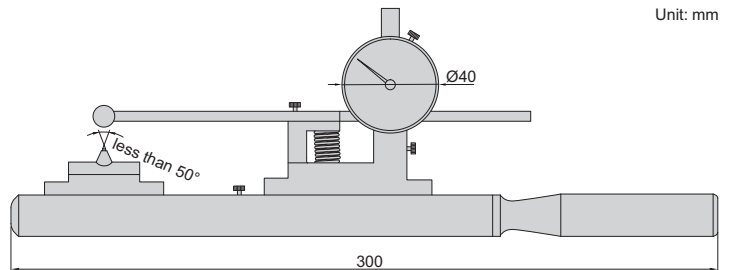


- Measure the height of internal thread with nominal diameter less than 5 1/2" (139.7mm)
- Optional accessory: thread height standard blocks (code 6250)

Code	Range	Dial indicator graduation	Accuracy
2233-35	0-3.5mm	0.01mm	0.02mm
2233-35E	0-1/4"	0.0005"	0.0008"



2233-35E



THREAD HEIGHT STANDARD BLOCKS

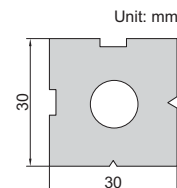
CAN BE CUSTOMIZED ACCORDING TO WORKPIECES

- Set zero of internal and external thread height measuring instruments (code 2232, 2233)

Code	Taper	Number of thread per inch
6250-4	1:4	4
6250-5	1:4	5
6250-8	1:16	8, 10
6250-51	1:16	5

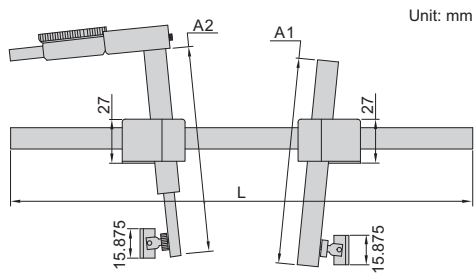


6250-8



MEET INTERNATIONAL
STANDARD API5B

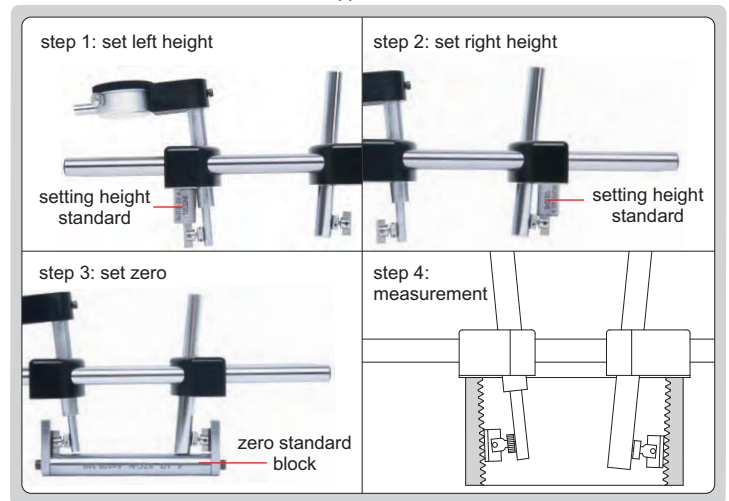
INTERNAL THREAD CREST DIAMETER MEASURING INSTRUMENTS



2237-5E

- Measure the crest diameter of internal thread with nominal diameter larger than 2 3/8" (60.325mm) and less than 20" (508mm)
- Optional accessory: height standard and zero standard block

application



Code	Range	Dial indicator stroke	Dial indicator graduation	Accuracy	L	A1	A2
2237-5	2 3/8-5 1/2"/60.325-139.7mm	5mm	0.01mm	0.02mm	260mm	112mm	91mm
2237-5E	2 3/8-5 1/2"/60.325-139.7mm	0.25"	0.0005"	0.0008"	260mm	112mm	91mm
2237-20	4 1/2"-20"/114.3-508mm	0.50"	0.0005"	0.002"	12", 18" or 24" *	177mm	182mm

* Select suitable length of arm according to workpieces



HEIGHT STANDARD AND ZERO STANDARD BLOCK (optional)

Code	Remark
2237-G□□□*	including height standard and zero standard block A (without taper)
2237-K□□□*	including height standard and zero standard block B (with taper)

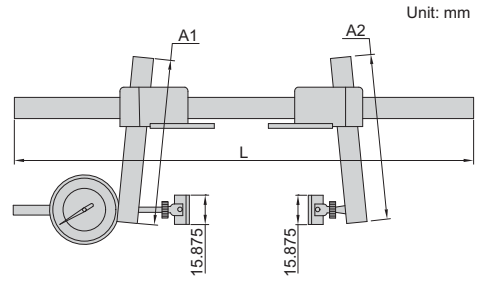
* Can be customized according to workpieces

EXTERNAL THREAD CREST DIAMETER MEASURING INSTRUMENTS

MEET INTERNATIONAL STANDARD API5B

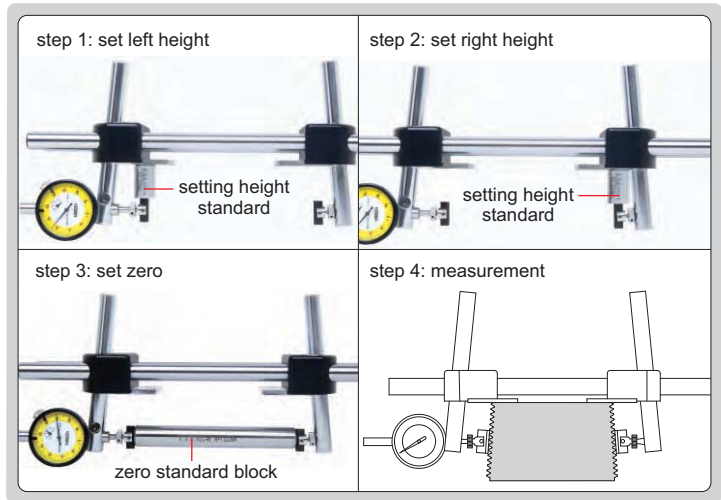


2236-5E



8

application



- Measure the crest diameter of external thread with nominal diameter larger than 2 3/8" (60.325mm) and less than 20" (508mm)
- Optional accessory: height standard and zero standard block

Code	Range	Dial indicator stroke	Dial indicator graduation	Accuracy	L	A1	A2
2236-5	2 3/8-5 1/2"/60.325-139.7mm	5mm	0.01mm	0.02mm	260mm	110mm	110mm
2236-5E	2 3/8-5 1/2"/60.325-139.7mm	0.25"	0.0005"	0.0008"	260mm	110mm	110mm
2236-20	2 3/8"-20"/60.325-508mm	0.50"	0.0005"	0.002"	12", 18" or 24"*	177mm	160mm

* Select suitable length of arm according to workpieces



HEIGHT STANDARD AND ZERO STANDARD BLOCK (optional)

Code	Remark
2236-G □□□ *	including height standard and zero standard block A (without taper)
2236-K □□□ *	including height standard and zero standard block B (with taper)

* Can be customized according to workpieces

GAGE BLOCKS

Accuracy according to ISO3650

Nominal length (mm)	Grade 0		Grade 1		Grade 2	
	Limit deviation of length	Tolerance for the variation in length	Limit deviation of length	Tolerance for the variation in length	Limit deviation of length	Tolerance for the variation in length
over 0.5 to 10	±0.12µm	0.10µm	±0.20µm	0.16µm	±0.45µm	0.30µm
over 10 to 25	±0.14µm	0.10µm	±0.30µm	0.16µm	±0.60µm	0.30µm
over 25 to 50	±0.20µm	0.10µm	±0.40µm	0.18µm	±0.80µm	0.30µm
over 50 to 75	±0.25µm	0.12µm	±0.50µm	0.18µm	±1.00µm	0.35µm
over 75 to 100	±0.30µm	0.12µm	±0.60µm	0.20µm	±1.20µm	0.35µm
over 100 to 150	±0.40µm	0.14µm	±0.80µm	0.20µm	±1.60µm	0.40µm
over 150 to 200	±0.50µm	0.16µm	±1.00µm	0.25µm	±2.00µm	0.40µm
over 200 to 250	±0.60µm	0.16µm	±1.20µm	0.25µm	±2.40µm	0.45µm
over 250 to 300	±0.70µm	0.18µm	±1.40µm	0.25µm	±2.80µm	0.50µm
over 300 to 400	±0.90µm	0.20µm	±1.80µm	0.30µm	±3.60µm	0.50µm
over 400 to 500	±1.10µm	0.25µm	±2.20µm	0.35µm	±4.40µm	0.60µm
over 500 to 600	±1.30µm	0.25µm	±2.60µm	0.40µm	±5.00µm	0.70µm
over 600 to 700	±1.50µm	0.30µm	±3.00µm	0.45µm	±6.00µm	0.70µm
over 700 to 800	±1.70µm	0.30µm	±3.40µm	0.50µm	±6.50µm	0.80µm
over 800 to 900	±1.90µm	0.35µm	±3.80µm	0.50µm	±7.50µm	0.90µm
over 900 to 1000	±2.00µm	0.40µm	±4.20µm	0.60µm	±8.00µm	1.00µm

Grade and application

Grade	Application
0	To be used as basic standards in calibration laboratories by skilled inspection staff, to calibrate or set high accuracy measuring instruments, to calibrate gage blocks of grade 1 and 2.
1	To be used in inspection rooms, to check gages, inspect high accuracy parts and set measuring instruments.
2	To be used in workshops, to check production gages, set measuring instruments and mount tools.



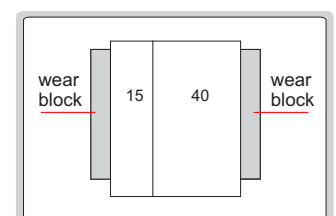
WEAR BLOCK SETS

- Protect the measuring surfaces of gage blocks from excessive wear
- Meet ISO3650
- Supplied with manufacturer inspection certificate

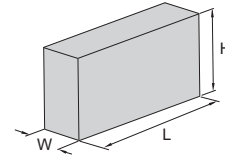


4111-2

Blocks per set	Size	Material	Code	
			Grade 0	Grade 1
2	1.0mm	ceramic	4111-1	4111-11
2	1.0mm	alloy steel	4111-1A	4111-11A
2	2.0mm	ceramic	4111-2	4111-12
2	2.0mm	alloy steel	4111-2A	4111-12A



CERAMIC GAGE BLOCK SETS



Dimension:

Size (L)	W	H
0.5 ≤ L ≤ 10mm	9mm	30mm
L > 10mm	9mm	35mm

4105-87

- Made of ceramic, extremely wear resistance and corrosion resistance, excellent dimension stability
- Meet ISO3650
- Supplied with manufacturer inspection certificate

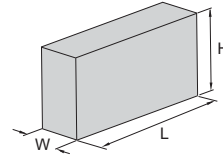
Blocks per set	Gage blocks included in set			Code	
	Size (mm)	Step (mm)	Quantity	Grade 0	Grade 1
112	1.0005		1	4105-112	4105-1112
	1.001-1.009	0.001	9		
	1.01-1.49	0.01	49		
	0.5-24.5	0.5	49		
	25-100	25	4		
103	1.005		1	4105-103	4105-1103
	1.01-1.49	0.01	49		
	0.5-24.5	0.5	49		
	25-100	25	4		
88	1.0005		1	4105-88	4105-188
	1.001-1.009	0.001	9		
	1.01-1.49	0.01	49		
	0.5-9.5	0.5	19		
	10-100	10	10		
87	1.001-1.009	0.001	9	4105-87	4105-187
	1.01-1.49	0.01	49		
	0.5-9.5	0.5	19		
	10-100	10	10		
76	1.005		1	4105-76	4105-176
	1.01-1.49	0.01	49		
	0.5-9.5	0.5	19		
	10-40	10	4		
	50-100	25	3		
56	0.5		1	4105-56	4105-156
	1.001-1.009	0.001	9		
	1.01-1.09	0.01	9		
	1.1-1.9	0.1	9		
	1-24	1	24		
	25-100	25	4		

Blocks per set	Gage blocks included in set			Code	
	Size (mm)	Step (mm)	Quantity	Grade 0	Grade 1
47	1.005		1	4105-47A	4105-147A
	1.01-1.09	0.01	9		
	1.1-1.9	0.1	9		
	1-24	1	24		
	25-100	25	4		
47	1.005		1	4105-47	4105-147
	1.01-1.19	0.01	19		
	1.2-1.9	0.1	8		
	1-9	1	9		
	10-100	10	10		
46	1.001-1.009	0.001	9	4105-46	4105-146
	1.01-1.09	0.01	9		
	1.1-1.9	0.1	9		
	1-9	1	9		
	10-100	10	10		
34	1.0005		1	4105-34	4105-134
	1.001-1.009	0.001	9		
	1.01-1.09	0.01	9		
	1.1-1.9	0.1	9		
	1-5	1	5		
32	10		1	4105-32	4105-132
	1.005		1		
	1.01-1.09	0.01	9		
	1.1-1.9	0.1	9		
	1-9	1	9		
	10-30	10	3		
50		1			

INDIVIDUAL CERAMIC GAGE BLOCKS



4106-A80



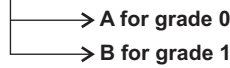
Dimension:

Size (L)	W	H
0.5 ≤ L ≤ 10mm	9mm	30mm
L > 10mm	9mm	35mm

- Grade 0 and 1 gage blocks are available
- Made of ceramic, extremely wear resistance and corrosion resistance
- Meet ISO3650
- Supplied with manufacturer inspection certificate

Code explanation:

4106-X□□□□



Code examples:

Size (L)	Grade	Code
0.5mm	0	4106-AD5
10mm	1	4106-B10

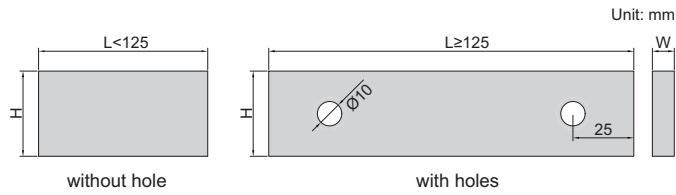
Size	Code
0.5mm	4106-XD5
1mm	4106-X1
1.0005mm	4106-X1D0005
1.001mm	4106-X1D001
1.002mm	4106-X1D002
1.003mm	4106-X1D003
1.004mm	4106-X1D004
1.005mm	4106-X1D005
1.006mm	4106-X1D006
1.007mm	4106-X1D007
1.008mm	4106-X1D008
1.009mm	4106-X1D009
1.01mm	4106-X1D01
1.02mm	4106-X1D02
1.03mm	4106-X1D03
1.04mm	4106-X1D04
1.05mm	4106-X1D05
1.06mm	4106-X1D06
1.07mm	4106-X1D07
1.08mm	4106-X1D08
1.09mm	4106-X1D09
1.1mm	4106-X1D1
1.11mm	4106-X1D11
1.12mm	4106-X1D12
1.13mm	4106-X1D13
1.14mm	4106-X1D14
1.15mm	4106-X1D15
1.16mm	4106-X1D16
1.17mm	4106-X1D17
1.18mm	4106-X1D18
1.19mm	4106-X1D19
1.2mm	4106-X1D2
1.21mm	4106-X1D21
1.22mm	4106-X1D22

Size	Code
1.23mm	4106-X1D23
1.24mm	4106-X1D24
1.25mm	4106-X1D25
1.26mm	4106-X1D26
1.27mm	4106-X1D27
1.28mm	4106-X1D28
1.29mm	4106-X1D29
1.3mm	4106-X1D3
1.31mm	4106-X1D31
1.32mm	4106-X1D32
1.33mm	4106-X1D33
1.34mm	4106-X1D34
1.35mm	4106-X1D35
1.36mm	4106-X1D36
1.37mm	4106-X1D37
1.38mm	4106-X1D38
1.39mm	4106-X1D39
1.4mm	4106-X1D4
1.41mm	4106-X1D41
1.42mm	4106-X1D42
1.43mm	4106-X1D43
1.44mm	4106-X1D44
1.45mm	4106-X1D45
1.46mm	4106-X1D46
1.47mm	4106-X1D47
1.48mm	4106-X1D48
1.49mm	4106-X1D49
1.5mm	4106-X1D5
1.6mm	4106-X1D6
1.7mm	4106-X1D7
1.8mm	4106-X1D8
1.9mm	4106-X1D9
2mm	4106-X2
2.5mm	4106-X2D5

Size	Code
3mm	4106-X3
3.5mm	4106-X3D5
4mm	4106-X4
4.5mm	4106-X4D5
5mm	4106-X5
5.1mm	4106-X5D1
5.5mm	4106-X5D5
6mm	4106-X6
6.5mm	4106-X6D5
7mm	4106-X7
7.5mm	4106-X7D5
7.7mm	4106-X7D7
8mm	4106-X8
8.5mm	4106-X8D5
9mm	4106-X9
9.5mm	4106-X9D5
10mm	4106-X10
10.3mm	4106-X10D3
10.5mm	4106-X10D5
11mm	4106-X11
11.5mm	4106-X11D5
12mm	4106-X12
12.5mm	4106-X12D5
12.9mm	4106-X12D9
13mm	4106-X13
13.5mm	4106-X13D5
14mm	4106-X14
14.5mm	4106-X14D5
15mm	4106-X15
15.5mm	4106-X15D5
16mm	4106-X16
16.5mm	4106-X16D5
17mm	4106-X17
17.5mm	4106-X17D5

Size	Code
17.6mm	4106-X17D6
18mm	4106-X18
18.5mm	4106-X18D5
19mm	4106-X19
19.5mm	4106-X19D5
20mm	4106-X20
20.2mm	4106-X20D2
20.5mm	4106-X20D5
21mm	4106-X21
21.5mm	4106-X21D5
22mm	4106-X22
22.5mm	4106-X22D5
22.8mm	4106-X22D8
23mm	4106-X23
23.5mm	4106-X23D5
24mm	4106-X24
24.5mm	4106-X24D5
25mm	4106-X25
30mm	4106-X30
40mm	4106-X40
41.3mm	4106-X41D3
50mm	4106-X50
60mm	4106-X60
70mm	4106-X70
75mm	4106-X75
80mm	4106-X80
90mm	4106-X90
100mm	4106-X100
125mm	4106-X125
131.4mm	4106-X131D4
150mm	4106-X150

STEEL GAGE BLOCK SETS



Dimension:

Size (L)	W	H
0.5 ≤ L ≤ 10mm	9mm	30mm
L > 10mm	9mm	35mm

Code example:
"-122" stands for "4100-122"



4100-87

- Made of alloy steel
- Meet ISO3650
- Gage blocks ≥ 125mm have clamping holes
- Supplied with manufacturer inspection certificate

9

Blocks per set	Gage blocks included in set			Code (4100)		
	Size (mm)	Step (mm)	Quantity	Grade 0	Grade 1	Grade 2
122	1.0005		1			
	1.001-1.009	0.001	9			
	1.01-1.49	0.01	49			
	1.6-1.9	0.1	4	-122	-1122	-2122
	0.5-24.5	0.5	49			
	30-100	10	8			
	25-75	50	2			
112	1.0005		1			
	1.001-1.009	0.001	9			
	1.01-1.49	0.01	49	-112	-1112	-2112
	0.5-24.5	0.5	49			
	25-100	25	4			
103	1.005		1			
	1.01-1.49	0.01	49	-103	-1103	-2103
	0.5-24.5	0.5	49			
	25-100	25	4			
88	1.0005		1			
	1.001-1.009	0.001	9			
	1.01-1.49	0.01	49	-88	-188	-288
	0.5-9.5	0.5	19			
	10-100	10	10			
87	1.001-1.009	0.001	9			
	1.01-1.49	0.01	49	-87	-187	-287
	0.5-9.5	0.5	19			
	10-100	10	10			
83	0.5		1			
	1		1			
	1.005		1			
	1.01-1.49	0.01	49	-83	-183	-283
	1.5-1.9	0.1	5			
	2-9.5	0.5	16			
10-100	10	10				
76	1.005		1			
	1.01-1.49	0.01	49			
	0.5-9.5	0.5	19	-76	-176	-276
	10-40	10	4			
	50-100	25	3			

Blocks per set	Gage blocks included in set			Code (4100)		
	Size (mm)	Step (mm)	Quantity	Grade 0	Grade 1	Grade 2
56	0.5		1			
	1.001-1.009	0.001	9			
	1.01-1.09	0.01	9	-56	-156	-256
	1.1-1.9	0.1	9			
	1-24	1	24			
	25-100	25	4			
47	1.005		1			
	1.01-1.09	0.01	9			
	1.1-1.9	0.1	9	-47A	-147A	-247A
	1-24	1	24			
47	1.005		1			
	1.01-1.19	0.01	19			
	1.2-1.9	0.1	8	-47	-147	-247
	1-9	1	9			
	10-100	10	10			
46	1.001-1.009	0.001	9			
	1.01-1.09	0.01	9			
	1.1-1.9	0.1	9	-46	-146	-246
	1-9	1	9			
	10-100	10	10			
34	1.0005		1			
	1.001-1.009	0.001	9			
	1.01-1.09	0.01	9	-34	-134	-234
	1.1-1.9	0.1	9			
	1-5	1	5			
	10		1			
32	1.005		1			
	1.01-1.09	0.01	9			
	1.1-1.9	0.1	9			
	1-9	1	9	-32	-132	-232
	10-30	10	3			
	50		1			
9	1.001-1.009	0.001	9	-9	-19	-29
9	0.991-0.999	0.001	9	-9A	-19A	-29A
8	125-175	25	3			
	200-250	50	2	-8	-18	-28
	300-500	100	3			

CUSTOM-MADE
CAN SUPPLY ANY SIZES FROM
0.5 TO 1000MM, SUCH AS 72.672MM



INDIVIDUAL STEEL GAGE BLOCKS

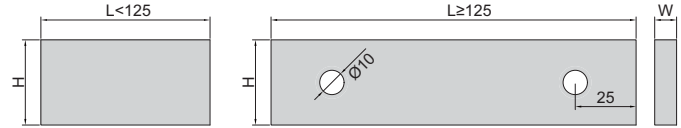


4101-A70



4101-A200

Unit: mm



without hole

with holes

- Grade 0, 1 and 2 gage blocks are available
- Made of alloy steel
- Meet ISO3650
- Gage blocks ≥ 125mm have clamping holes
- Supplied with manufacturer inspection certificate

Code explanation:

4101-X□□□□□

- A for grade 0
- B for grade 1
- C for grade 2

Code examples:

Size (L)	Grade	Code
0.5mm	0	4101-AD5
1mm	1	4101-B1
10.5mm	2	4101-C10D5

Dimension:

Size (L)	W	H
0.5 ≤ L ≤ 10mm	9mm	30mm
L > 10mm	9mm	35mm

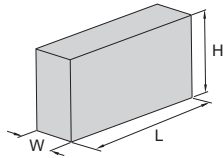
Size	Code
0.5mm	4101-XD5
0.991mm	4101-XD991
0.992mm	4101-XD992
0.993mm	4101-XD993
0.994mm	4101-XD994
0.995mm	4101-XD995
0.996mm	4101-XD996
0.997mm	4101-XD997
0.998mm	4101-XD998
0.999mm	4101-XD999
1mm	4101-X1
1.0005mm	4101-X1D0005
1.001mm	4101-X1D001
1.002mm	4101-X1D002
1.003mm	4101-X1D003
1.004mm	4101-X1D004
1.005mm	4101-X1D005
1.006mm	4101-X1D006
1.007mm	4101-X1D007
1.008mm	4101-X1D008
1.009mm	4101-X1D009
1.01mm	4101-X1D01
1.02mm	4101-X1D02
1.03mm	4101-X1D03
1.04mm	4101-X1D04
1.05mm	4101-X1D05
1.06mm	4101-X1D06
1.07mm	4101-X1D07
1.08mm	4101-X1D08
1.09mm	4101-X1D09
1.1mm	4101-X1D1
1.11mm	4101-X1D11
1.12mm	4101-X1D12
1.13mm	4101-X1D13
1.14mm	4101-X1D14
1.15mm	4101-X1D15
1.16mm	4101-X1D16
1.17mm	4101-X1D17
1.18mm	4101-X1D18

Size	Code
1.19mm	4101-X1D19
1.2mm	4101-X1D2
1.21mm	4101-X1D21
1.22mm	4101-X1D22
1.23mm	4101-X1D23
1.24mm	4101-X1D24
1.25mm	4101-X1D25
1.26mm	4101-X1D26
1.27mm	4101-X1D27
1.28mm	4101-X1D28
1.29mm	4101-X1D29
1.3mm	4101-X1D3
1.31mm	4101-X1D31
1.32mm	4101-X1D32
1.33mm	4101-X1D33
1.34mm	4101-X1D34
1.35mm	4101-X1D35
1.36mm	4101-X1D36
1.37mm	4101-X1D37
1.38mm	4101-X1D38
1.39mm	4101-X1D39
1.4mm	4101-X1D4
1.41mm	4101-X1D41
1.42mm	4101-X1D42
1.43mm	4101-X1D43
1.44mm	4101-X1D44
1.45mm	4101-X1D45
1.46mm	4101-X1D46
1.47mm	4101-X1D47
1.48mm	4101-X1D48
1.49mm	4101-X1D49
1.5mm	4101-X1D5
1.6mm	4101-X1D6
1.7mm	4101-X1D7
1.8mm	4101-X1D8
1.9mm	4101-X1D9
2mm	4101-X2
2.5mm	4101-X2D5
3mm	4101-X3

Size	Code
3.5mm	4101-X3D5
4mm	4101-X4
4.5mm	4101-X4D5
5mm	4101-X5
5.1mm	4101-X5D1
5.5mm	4101-X5D5
6mm	4101-X6
6.5mm	4101-X6D5
7mm	4101-X7
7.5mm	4101-X7D5
7.7mm	4101-X7D7
8mm	4101-X8
8.5mm	4101-X8D5
9mm	4101-X9
9.5mm	4101-X9D5
10mm	4101-X10
10.3mm	4101-X10D3
10.5mm	4101-X10D5
11mm	4101-X11
11.5mm	4101-X11D5
12mm	4101-X12
12.5mm	4101-X12D5
12.9mm	4101-X12D9
13mm	4101-X13
13.5mm	4101-X13D5
14mm	4101-X14
14.5mm	4101-X14D5
15mm	4101-X15
15.5mm	4101-X15D5
16mm	4101-X16
16.5mm	4101-X16D5
17mm	4101-X17
17.5mm	4101-X17D5
17.6mm	4101-X17D6
18mm	4101-X18
18.5mm	4101-X18D5
19mm	4101-X19
19.5mm	4101-X19D5
20mm	4101-X20

Size	Code
20.2mm	4101-X20D2
20.5mm	4101-X20D5
21mm	4101-X21
21.5mm	4101-X21D5
22mm	4101-X22
22.5mm	4101-X22D5
22.8mm	4101-X22D8
23mm	4101-X23
23.5mm	4101-X23D5
24mm	4101-X24
24.5mm	4101-X24D5
25mm	4101-X25
30mm	4101-X30
35mm	4101-X35
40mm	4101-X40
41.3mm	4101-X41D3
45mm	4101-X45
50mm	4101-X50
60mm	4101-X60
70mm	4101-X70
75mm	4101-X75
80mm	4101-X80
90mm	4101-X90
100mm	4101-X100
125mm	4101-X125
131.4mm	4101-X131D4
150mm	4101-X150
175mm	4101-X175
200mm	4101-X200
250mm	4101-X250
300mm	4101-X300
400mm	4101-X400
500mm	4101-X500
600mm	4101-X600
700mm	4101-X700
750mm	4101-X750
800mm	4101-X800
900mm	4101-X900
1000mm	4101-X1000

CARBIDE GAGE BLOCK SETS



Dimension:

Size (L)	W	H
0.5 ≤ L ≤ 10mm	9mm	30mm
L > 10mm	9mm	35mm



4164-32

- Made of carbide, extremely wear resistance and corrosion resistance, excellent dimension stability
- Meet ISO3650
- Supplied with manufacturer inspection certificate

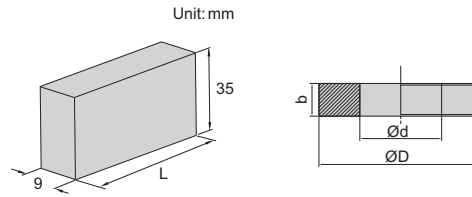
Blocks per set	Gage blocks included in set			Code	
	Size (mm)	Step (mm)	Quantity	Grade 0	Grade 1
122	1.0005		1	4164-122	4164-1122
	1.001-1.009	0.001	9		
	1.01-1.49	0.01	49		
	1.6-1.9	0.1	4		
	0.5-24.5	0.5	49		
	30-100	10	8		
	25-75	50	2		
112	1.0005		1	4164-112	4164-1112
	1.001-1.009	0.001	9		
	1.01-1.49	0.01	49		
	0.5-24.5	0.5	49		
	25-100	25	4		
103	1.005		1	4164-103	4164-1103
	1.01-1.49	0.01	49		
	0.5-24.5	0.5	49		
	25-100	25	4		
87	1.001-1.009	0.001	9	4164-87	4164-187
	1.01-1.49	0.01	49		
	0.5-9.5	0.5	19		
	10-100	10	10		
83	0.5		1	4164-83	4164-183
	1		1		
	1.005		1		
	1.01-1.49	0.01	49		
	1.5-1.9	0.1	5		
	2-9.5	0.5	16		
	10-100	10	10		

Blocks per set	Gage blocks included in set			Code	
	Size (mm)	Step (mm)	Quantity	Grade 0	Grade 1
76	1.005		1	4164-76	4164-176
	1.01-1.49	0.01	49		
	0.5-9.5	0.5	19		
	10-40	10	4		
	50-100	25	3		
47	1.005		1	4164-47A	4164-147A
	1.01-1.09	0.01	9		
	1.1-1.9	0.1	9		
	1-24	1	24		
47	25-100	25	4	4164-47	4164-147
	1.005		1		
	1.01-1.19	0.01	19		
	1.2-1.9	0.1	8		
	1-9	1	9		
46	10-100	10	10	4164-46	4164-146
	1.001-1.009	0.001	9		
	1.01-1.09	0.01	9		
	1.1-1.9	0.1	9		
	1-9	1	9		
32	10-100	10	10	4164-32	4164-132
	1.005		1		
	1.01-1.09	0.01	9		
	1.1-1.9	0.1	9		
	1-9	1	9		
	10-30	10	3		
	50		1		

CALIPER INSPECTION GAGE BLOCK AND RING GAGE SET



4176-30



Ring gage sizes:

diameter (Ød)*	b	ØD
Ø4mm	5mm	22mm
Ø25mm	14mm	53mm

* The size of the ring gage when supplied may have deviation. For example, the size Ø25mm may be 24.996mm

- Gage blocks meet ISO3650/grade 2
- Ring gages meet DIN2250-1:2008
- Supplied with manufacturer inspection certificate

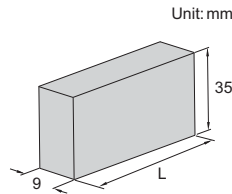
(mm)

Code	Material	Gage blocks included in set (L)	Ring gages included in set (Ød)	Applicable calipers
4176-30	alloy steel	30, 41.3, 131.4	4, 25	0-150

CALIPER INSPECTION GAGE BLOCK SET



4108-3005



- Meet ISO3650/grade 2
- Supplied with manufacturer inspection certificate

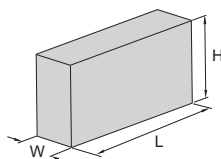
(mm)

Code	Material	Gage blocks included in set (L)	Applicable calipers
4108-3005	alloy steel	30, 41.3, 131.4, 243.5, 281.2	0-150, 0-200, 0-300

MICROMETER INSPECTION GAGE BLOCK SETS



4107-10



Dimension:

Size (L)	W	H
0.5 ≤ L ≤ 10mm	9mm	30mm
L > 10mm	9mm	35mm

- One piece of optical flat is included in 4107-10 and 4107-101
- Meet ISO3650/grade 0
- Supplied with manufacturer inspection certificate



Code	Material	Gage blocks included in set	Applicable micrometer	Optical flat
4107-10	ceramic	2.5mm, 5.1mm, 7.7mm, 10.3mm, 12.9mm, 15mm, 17.6mm, 20.2mm, 22.8mm, 25mm, optical flat	0-25mm	included
4107-101	alloy steel	2.5mm, 5.1mm, 7.7mm, 10.3mm, 12.9mm, 15mm, 17.6mm, 20.2mm, 22.8mm, 25mm, optical flat	0-25mm	included
4107-112	alloy steel	25mm, 27.5mm, 30.1mm, 32.7mm, 35.3mm, 37.9mm, 40mm, 42.6mm, 45.2mm, 47.8mm, 50mm	25-50mm	not included
4107-113	alloy steel	50mm, 52.5mm, 55.1mm, 57.7mm, 60.3mm, 62.9mm, 65mm, 67.6mm, 70.2mm, 72.8mm, 75mm	50-75mm	not included
4107-114	alloy steel	75mm, 77.5mm, 80.1mm, 82.7mm, 85.3mm, 87.9mm, 90mm, 92.6mm, 95.2mm, 97.8mm, 100mm	75-100mm	not included
4107-115	alloy steel	5.12mm, 10.24mm, 15.36mm, 21.5mm, 25mm, 30.12mm, 35.24mm, 40.36mm, 46.5mm, 50mm, 55.12mm, 60.24mm, 65.36mm, 71.5mm, 75mm, 80.12mm, 85.24mm, 90.36mm, 96.5mm, 100mm	0-100mm	not included

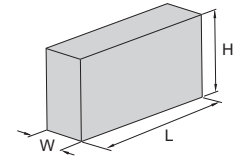
MICROMETER INSPECTION GAGE BLOCK SET



application



4160-10



Dimension:

Size (L)	W	H
$0.5 \leq L \leq 10\text{mm}$	9mm	30mm
$L > 10\text{mm}$	9mm	35mm

- Meet ISO3650/grade 0
- One piece of optical flat is included (size $\varnothing 30 \times 12\text{mm}$)
- Supplied with manufacturer inspection certificate

optical flat (included)



Code	Material	Gage blocks included in set	Applicable micrometer
4160-10	alloy steel	2.5mm, 5.1mm, 7.7mm, 10.3mm, 12.9mm, 15mm, 17.6mm, 20.2mm, 22.8mm, 25mm	0-25mm

9

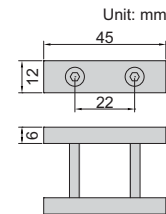
GAGE BLOCK HOLDERS

- Made of aluminum
- To be used with individual steel gage blocks (code 4101) as Go and No-Go gage

Code	Applicable gage block size
6883-1	1.5-5mm
6883-2	5-10mm
6883-3	10-15mm
6883-4	15-20mm
6883-5	20-25mm



6883-4



To be used as Go and No-Go gage



GAGE BLOCK HOLDER

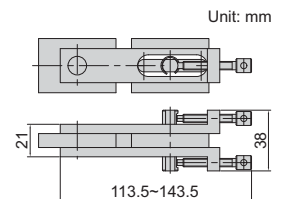


- For gage blocks over 100mm with clamping holes
- Optional accessory: gage block holder accessory, gage block accessory (code 6881)

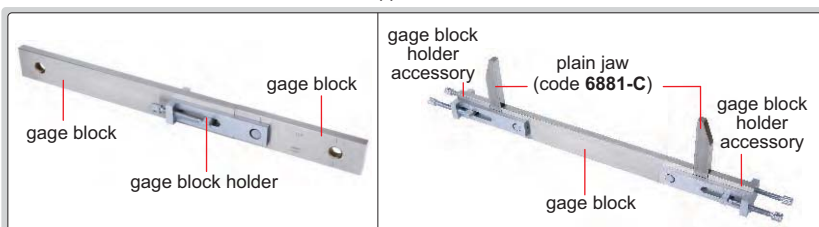
Code
6886-1



6886-1



application

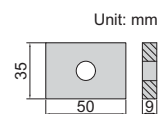


GAGE BLOCK HOLDER ACCESSORY

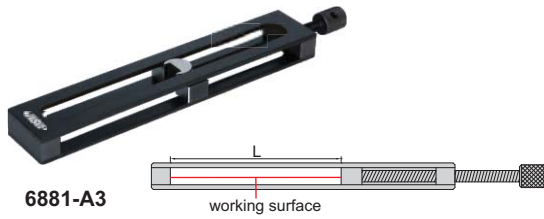
Code
6886-A



6886-A



GAGE BLOCK ACCESSORIES



6881-A3

Code	Name	Clamping range* (L)
6881-A1	holder	0-25mm
6881-A2	holder	25-50mm
6881-A3	holder	50-100mm
6881-A4	holder	100-200mm
6881-A5	holder	200-300mm
6881-A6**	holder	300-500mm

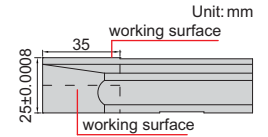
* The actual clamping range should deduct the width of jaws
 ** Not suitable for base 6881-B



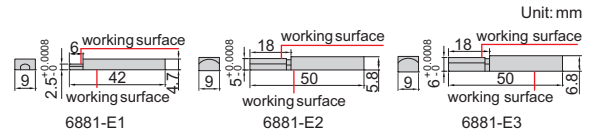
Code	Name
6881-B	base



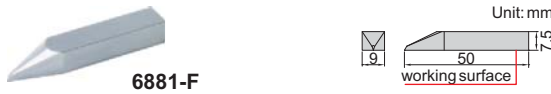
6881-B



6881-E2



Code	Name	Size	Remark
6881-E1	half round jaw	2.5mm	made of carbide, supplied in pair
6881-E2	half round jaw	5.0mm	made of carbide, supplied in pair
6881-E3	half round jaw	6.0mm	made of carbide, supplied in pair

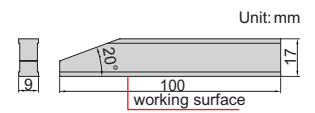


6881-F

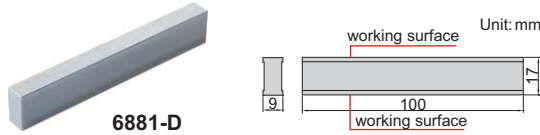
Code	Name	Remark
6881-F	scraper	made of carbide



6881-C



Code	Name	Remark
6881-C	plain jaw	made of carbide, supplied in pair

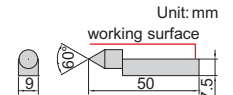


6881-D

Code	Name	Remark
6881-D	parallel jaw	made of carbide



6881-G



Code	Name	Remark
6881-G	centre point	the tip is made of carbide



6881-S17

GAGE BLOCK ACCESSORY SET

Code	Remark
6881-S17	17 pcs (including below items)

holder, 0-25mm (code 6881-A1)	1 pc
holder, 25-50mm (code 6881-A2)	1 pc
holder, 50-100mm (code 6881-A3)	1 pc
holder, 100-200mm (code 6881-A4)	1 pc
holder, 200-300mm (code 6881-A5)	1 pc
base (code 6881-B)	1 pc
plain jaw (code 6881-C)	1 pair
parallel jaw (code 6881-D)	1 pc
half round jaw, 2.5mm (code 6881-E1)	1 pair
half round jaw, 5.0mm (code 6881-E2)	1 pair
half round jaw, 6.0mm (code 6881-E3)	1 pair
scraper (code 6881-F)	1 pc
centre point (code 6881-G)	1 pc

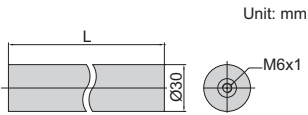
application

<p>(plain jaw+holder) set zero for bore gage and inside micrometers</p>	<p>(base+holder+scraper) measure height or scribe</p>	<p>(half round jaw+holder) measure inside diameter</p>
<p>(scraper+centre point+holder) scribe circle</p>	<p>(plain jaw+parallel jaw+holder) Go and No Go inspection</p>	

CYLINDER GAGE BLOCKS

CUSTOM-MADE
CAN SUPPLY ANY LENGTH, SUCH AS 80.672MM

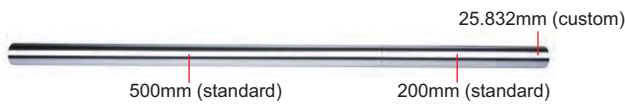
**INSPECTION
CERTIFICATE**



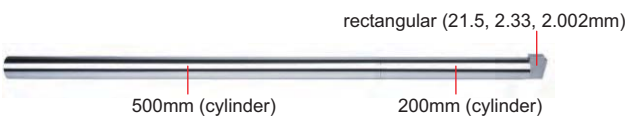
- Made of special alloy steel, hardness HRC64, high stability, wear resistance and easy combination
- Meet ISO3650 grade 1
- Can be connected with M6x1 screw and combined to any sizes up to 4m

can be combined to any sizes up to 4m

Combination 1: combined by several standard size cylinder gage blocks and one custom size cylinder gage block
For example: 500 (standard) + 200 (standard) + 25.832 (custom)=725.832mm
Note: in order to reduce cost, custom size should be within 100mm



Combination 2: combined by standard size cylinder gage blocks and rectangular gage blocks
For example: 500 (cylinder) + 200 (cylinder) + 21.5 (rectangular) + 2.33 (rectangular) + 2.002 (rectangular)=725.832mm



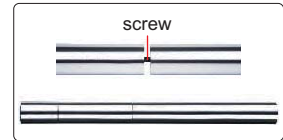
Code	Length (L)
4001-25 *	25mm
4001-50 *	50mm
4001-75 *	75mm
4001-100 *	100mm
4001-200 *	200mm
4001-300 *	300mm
4001-400 *	400mm
4001-500 *	500mm

*Supplied with manufacturer inspection certificate

high stability in vertical position,
suitable for checking height gages



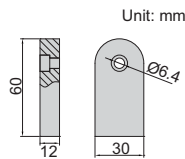
connected with M6x1mm screw



INTERNAL BLOCKS



4001-A



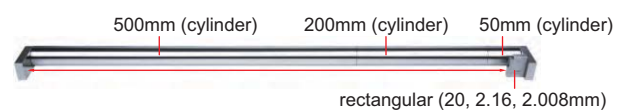
- Can be attached to cylinder and rectangular gage blocks
- Made of special alloy steel, hardness HRC64, high stability, wear resistance and easy combination
- Supplied in a matched pair

Code	Size	Flatness
4001-A	12mm	0.2µm

Combination 1: combined by several standard size cylinder gage blocks and one custom size cylinder gage block
For example: 500 (standard) + 200 (standard) + 25.832 (custom)=725.832mm
Note: in order to reduce cost, custom size should be within 100mm



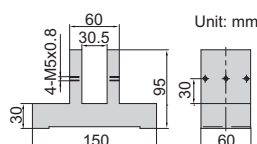
Combination 2: combined by standard size cylinder gage blocks and rectangular gage blocks
For example: 500 (cylinder) + 200 (cylinder) + 50 (rectangular) - 20 (rectangular) - 2.16 (rectangular) - 2.008 (rectangular)=725.832mm



BASE

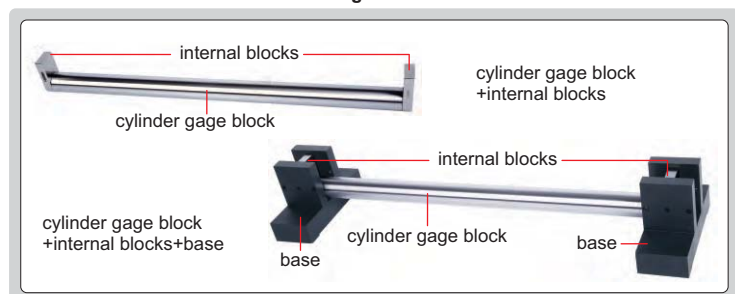


4001-B

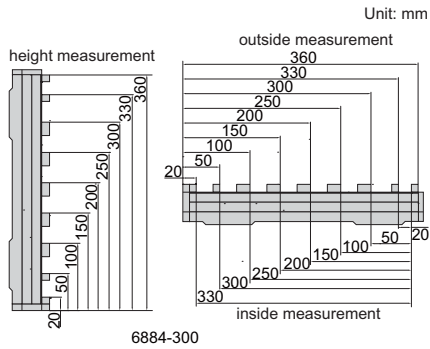


Code	Remark
4001-B	supplied in pair

working with base



CALIPER/HEIGHT GAGE CHECKERS



6884-300

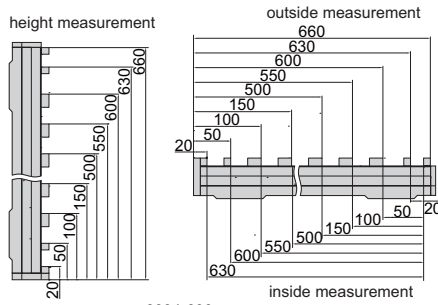


horizontal use



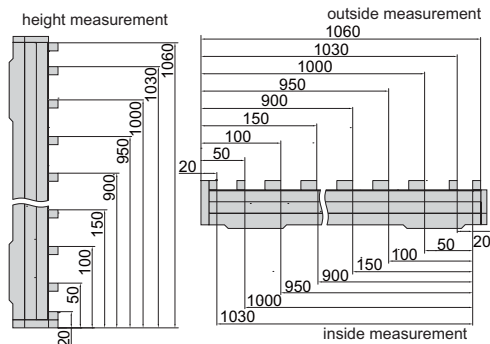
vertical use

6884-300



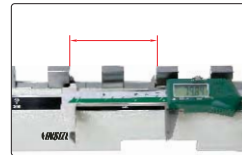
6884-600

- To check calipers and height gages
- Constructed with steel gage blocks

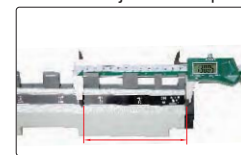


6884-1000

check upper jaws of calipers



check lower jaws of calipers



check height gages



(mm)

Code	Size	Range of inside measurement	Range of outside measurement	Range of height measurement	Accuracy
6884-300*	0-300mm	20, 50, 100, 150, 200, 250, 300, 330	20, 50, 100, 150, 200, 250, 300, 330, 360	20, 50, 100, 150, 200, 250, 300, 330, 360	±3µm
6884-600*	0-600mm	20, 50, 100, 150, 200, 250, 300, 350, 400, 450, 500, 550, 600, 630	20, 50, 100, 150, 200, 250, 300, 350, 400, 450, 500, 550, 600, 630, 660	20, 50, 100, 150, 200, 250, 300, 350, 400, 450, 500, 550, 600, 630, 660	±5µm
6884-1000*	0-1000mm	20, 50, 100, 150, 200, 250, 300, 350, 400, 450, 500, 550, 600, 650, 700, 750, 800, 850, 900, 950, 1000, 1030	20, 50, 100, 150, 200, 250, 300, 350, 400, 450, 500, 550, 600, 650, 700, 750, 800, 850, 900, 950, 1000, 1030, 1060	20, 50, 100, 150, 200, 250, 300, 350, 400, 450, 500, 550, 600, 650, 700, 750, 800, 850, 900, 950, 1000, 1030, 1060	±7µm

* Supplied with manufacturer inspection certificate

INSIDE MICROMETER ACCESSORIES

- Supplied with a pair of 5mm carbide gage blocks

Code	Applicable caliper/height gage checker
6884-A3*	0-300mm/0-600mm
6884-A10*	0-1000mm

* Supplied with manufacturer inspection certificate



6884-A3

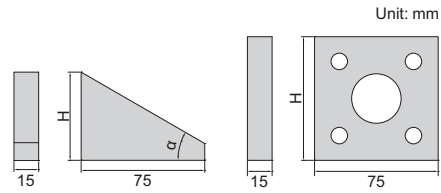
set inside micrometers



ANGLE GAGE BLOCKS



4002-15



inspect angle



set angle of plate

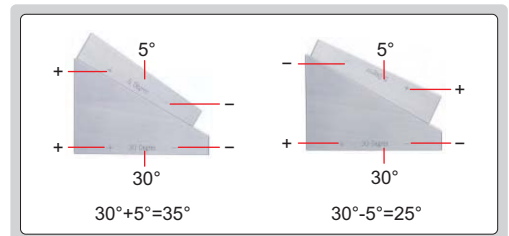


- Accuracy: $\pm 2''$
- To inspect protractor, taper gage, index plate, index head and goniometer, can also be used to set angle
- Made of special alloy steel, hardness HRC64, high stability, wear resistance and easy combination
- Can be combined to any angle with interval 6 seconds after combination (6", 12", 18", ... , 360°)

Individual

Code	Angle (α)	H (mm)
4002-A1 *	1°	11.5
4002-A3 *	3°	14.0
4002-A5 *	5°	16.5
4002-A9 *	9°	22.0
4002-A15 *	15°	30.5
4002-A27 *	27°	48.0
4002-A30 *	30°	53.5
4002-A41 *	41°	75.0
4002-A45 *	45°	84.0
4002-B1 *	1'	10.0
4002-B3 *	3'	10.0
4002-B5 *	5'	10.0
4002-B9 *	9'	10.0
4002-B20 *	20'	10.0
4002-B27 *	27'	10.0
4002-B30 *	30'	10.0
4002-C6 *	6"	10.0
4002-C12 *	12"	10.0
4002-C18 *	18"	10.0
4002-C30 *	30"	10.0
4002-D *	90°/90°/90°/90°	75.0

combination



Set

Code	Angle (α)	Total quantity
4002-13 *	1°, 3°, 9°, 27°, 41°, 1', 3', 9', 27', 6", 18", 30", 90°/90°/90°/90°	13
4002-15 *	1°, 3°, 5°, 15°, 30°, 45°, 1', 3', 5', 20', 30', 6", 12", 30", 90°/90°/90°/90°	15

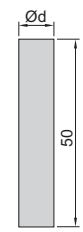
* Supplied with manufacturer inspection certificate

PIN GAGE SETS

- Meet DIN2269, grade 1
- Made of alloy steel
- Hardness HRC62-65
- Diameter accuracy: $\pm 1\mu\text{m}$



Unit: mm



4166-6D

Code	Diameter Ød (mm)	Step	Pin gages per set
4166-2S	1.00, 1.01, 1.02, ..., 2.00	0.01mm	101
4166-3S	2.00, 2.01, 2.02, ..., 3.00	0.01mm	101
4166-4S	3.00, 3.01, 3.02, ..., 4.00	0.01mm	101
4166-5S	4.00, 4.01, 4.02, ..., 5.00	0.01mm	101
4166-6S	5.00, 5.01, 5.02, ..., 6.00	0.01mm	101
4166-7S	6.00, 6.01, 6.02, ..., 7.00	0.01mm	101
4166-8S	7.00, 7.01, 7.02, ..., 8.00	0.01mm	101
4166-9S	8.00, 8.01, 8.02, ..., 9.00	0.01mm	101
4166-10S	9.00, 9.01, 9.02, ..., 10.00	0.01mm	101

Code	Diameter Ød (mm)	Step	Pin gages per set
4166-411	1.0, 1.1, 1.2, ..., 5.0	0.1mm	41
4166-511	5.0, 5.1, 5.2, ..., 10.0	0.1mm	51
4166-512	10.0, 10.1, 10.2, ..., 15.0	0.1mm	51
4166-513	15.0, 15.1, 15.2, ..., 20.0	0.1mm	51

Code	Diameter Ød (mm)	Step	Pin gages per set
4166-0D	0.20, 0.21, 0.22, ..., 0.50	0.01mm	31
4166-1	0.50, 0.51, 0.52, ..., 1.00	0.01mm	51
4166-1D	1.00, 1.01, 1.02, ..., 1.50	0.01mm	51
4166-2	1.50, 1.51, 1.52, ..., 2.00	0.01mm	51
4166-2D	2.00, 2.01, 2.02, ..., 2.50	0.01mm	51
4166-3	2.50, 2.51, 2.52, ..., 3.00	0.01mm	51
4166-3D	3.00, 3.01, 3.02, ..., 3.50	0.01mm	51
4166-4	3.50, 3.51, 3.52, ..., 4.00	0.01mm	51
4166-4D	4.00, 4.01, 4.02, ..., 4.50	0.01mm	51
4166-5	4.50, 4.51, 4.52, ..., 5.00	0.01mm	51
4166-5D	5.00, 5.01, 5.02, ..., 5.50	0.01mm	51
4166-6	5.50, 5.51, 5.52, ..., 6.00	0.01mm	51
4166-6D	6.00, 6.01, 6.02, ..., 6.50	0.01mm	51
4166-7	6.50, 6.51, 6.52, ..., 7.00	0.01mm	51
4166-7D	7.00, 7.01, 7.02, ..., 7.50	0.01mm	51
4166-8	7.50, 7.51, 7.52, ..., 8.00	0.01mm	51
4166-8D	8.00, 8.01, 8.02, ..., 8.50	0.01mm	51
4166-9	8.50, 8.51, 8.52, ..., 9.00	0.01mm	51
4166-9D	9.00, 9.01, 9.02, ..., 9.50	0.01mm	51
4166-10	9.50, 9.51, 9.52, ..., 10.00	0.01mm	51

Code	Diameter Ød (mm)	Step	Pin gages per set
4166-10D	10.00, 10.01, 10.02, ..., 10.50	0.01mm	51
4166-11	10.50, 10.51, 10.52, ..., 11.00	0.01mm	51
4166-11D	11.00, 11.01, 11.02, ..., 11.50	0.01mm	51
4166-12	11.50, 11.51, 11.52, ..., 12.00	0.01mm	51
4166-12D	12.00, 12.01, 12.02, ..., 12.50	0.01mm	51
4166-13	12.50, 12.51, 12.52, ..., 13.00	0.01mm	51
4166-13D	13.00, 13.01, 13.02, ..., 13.50	0.01mm	51
4166-14	13.50, 13.51, 13.52, ..., 14.00	0.01mm	51
4166-14D	14.00, 14.01, 14.02, ..., 14.50	0.01mm	51
4166-15	14.50, 14.51, 14.52, ..., 15.00	0.01mm	51
4166-15D	15.00, 15.01, 15.02, ..., 15.50	0.01mm	51
4166-16	15.50, 15.51, 15.52, ..., 16.00	0.01mm	51
4166-16D	16.00, 16.01, 16.02, ..., 16.50	0.01mm	51
4166-17	16.50, 16.51, 16.52, ..., 17.00	0.01mm	51
4166-17D	17.00, 17.01, 17.02, ..., 17.50	0.01mm	51
4166-18	17.50, 17.51, 17.52, ..., 18.00	0.01mm	51
4166-18D	18.00, 18.01, 18.02, ..., 18.50	0.01mm	51
4166-19	18.50, 18.51, 18.52, ..., 19.00	0.01mm	51
4166-19D	19.00, 19.01, 19.02, ..., 19.50	0.01mm	51
4166-20	19.50, 19.51, 19.52, ..., 20.00	0.01mm	51

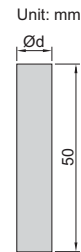
INDIVIDUAL PIN GAGES WITH TWO DECIMAL PLACES (0.01MM STEP)

- Meet DIN2269, grade 1
- Diameter range: $\varnothing 0.20\sim\varnothing 20.00\text{mm}$
- Diameter accuracy: $\pm 1\mu\text{m}$
- Made of alloy steel
- Hardness HRC62-65
- Optional accessory: wooden box

Diameter $\varnothing d$ (mm)	Diameter $\varnothing d$ (mm)
0.20, 0.21, 0.22, 0.23, ... 1.00	10.01, 10.02, 10.03, 10.04, ... 11.00
1.01, 1.02, 1.03, 1.04, ... 2.00	11.01, 11.02, 11.03, 11.04, ... 12.00
2.01, 2.02, 2.03, 2.04, ... 3.00	12.01, 12.02, 12.03, 12.04, ... 13.00
3.01, 3.02, 3.03, 3.04, ... 4.00	13.01, 13.02, 13.03, 13.04, ... 14.00
4.01, 4.02, 4.03, 4.04, ... 5.00	14.01, 14.02, 14.03, 14.04, ... 15.00
5.01, 5.02, 5.03, 5.04, ... 6.00	15.01, 15.02, 15.03, 15.04, ... 16.00
6.01, 6.02, 6.03, 6.04, ... 7.00	16.01, 16.02, 16.03, 16.04, ... 17.00
7.01, 7.02, 7.03, 7.04, ... 8.00	17.01, 17.02, 17.03, 17.04, ... 18.00
8.01, 8.02, 8.03, 8.04, ... 9.00	18.01, 18.02, 18.03, 18.04, ... 19.00
9.01, 9.02, 9.03, 9.04, ... 10.00	19.01, 19.02, 19.03, 19.04, ... 20.00



4110-9D98



Code
4110-□□□□

Ordering examples:

Diameter	Code
0.21mm	4110-0D21
5.56mm	4110-5D56
16.00mm	4110-16D00

Note : "D" stands for "."

INDIVIDUAL PIN GAGES WITH THREE DECIMAL PLACES (0.001MM STEP)



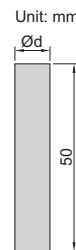
- Meet DIN2269, grade 1
- Diameter range: $\varnothing 0.200\sim\varnothing 30.000\text{mm}$ with three decimal, for example 0.211mm, 5.562mm, 16.298mm
- Diameter accuracy: $\pm 1\mu\text{m}$
- Made of alloy steel
- Hardness HRC62-65
- Optional accessory: wooden box

Code	Diameter range $\varnothing d$ (mm)
4118-□□□□*	0.200~30.000

*Supplied with manufacturer inspection certificate



4118-8D015



Ordering examples:

Diameter	Code
0.211mm	4118-0D211
5.562mm	4118-5D562
16.298mm	4118-16D298

Note : "D" stands for "."

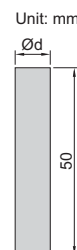
INDIVIDUAL CERAMIC PIN GAGES WITH TWO DECIMAL PLACES (0.01MM STEP)

- Meet DIN2269, grade 1
- Diameter range: $\varnothing 0.50\sim\varnothing 10.00\text{mm}$
- Diameter accuracy: $\pm 1\mu\text{m}$
- Made of ceramic, extremely wear resistance, corrosion resistance and dimensional stability
- Optional accessory: wooden box (code 7340)

Diameter $\varnothing d$ (mm)
0.50, 0.51, 0.52, 0.53, ... 1.00
1.01, 1.02, 1.03, 1.04, ... 2.00
2.01, 2.02, 2.03, 2.04, ... 3.00
3.01, 3.02, 3.03, 3.04, ... 4.00
4.01, 4.02, 4.03, 4.04, ... 5.00
5.01, 5.02, 5.03, 5.04, ... 6.00
6.01, 6.02, 6.03, 6.04, ... 7.00
7.01, 7.02, 7.03, 7.04, ... 8.00
8.01, 8.02, 8.03, 8.04, ... 9.00
9.01, 9.02, 9.03, 9.04, ... 10.00



4113-3D00



Code
4113-□□□□

Ordering examples:

Diameter	Code
0.21mm	4113-0D21
5.56mm	4113-5D56
10.00mm	4113-10D00

Note : "D" stands for "."

BOXES FOR PIN GAGES

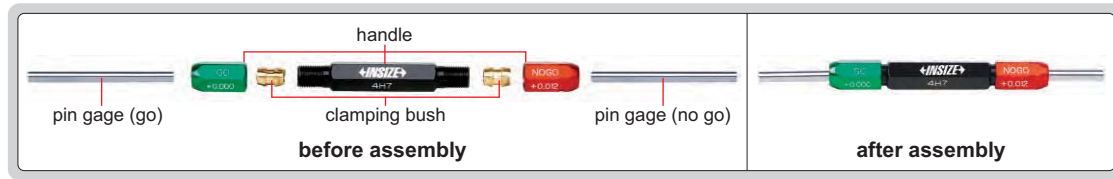
- For individual pin gages (4110, 4113 and 4118 series)

Code	Applicable pin gage diameter Ød	Quantity of pin gages
7340	0.20-10.00mm	51 pcs
7340-101	0.20-10.00mm	101 pcs
7340-201	10.00-15.00mm	51 pcs
7340-202	15.00-20.00mm	51 pcs



7340

PIN GAGE HANDLES



- Wrench is needed to install pins
- Clamping bushes (0.2~7.14mm) are made of brass, clamping bushes (7.14~25.65mm) are made of aluminum



Handle



brass clamping bush (0.2~7.14mm)



aluminum clamping bush (7.14~25.65mm)

Code	Applicable pin gage diameter	Including	
		Handle	Clamping bush (mm)
7341-0S	0.2-1.02mm	1 pc	6 pairs (the clamping range are 0.2-0.38, 0.38-0.51, 0.51-0.64, 0.64-0.76, 0.76-0.89, 0.89-1.02)
7341-1S	1.02-1.91mm	1 pc	7 pairs (the clamping range are 1.02-1.14, 1.14-1.27, 1.27-1.40, 1.40-1.52, 1.52-1.65, 1.65-1.78, 1.78-1.91)
7341-2S	1.91-3.33mm	1 pc	8 pairs (the clamping range are 1.91-2.08, 2.08-2.26, 2.26-2.44, 2.44-2.62, 2.62-2.79, 2.79-2.97, 2.97-3.15, 3.15-3.33)
7341-3S	3.33-4.57mm	1 pc	7 pairs (the clamping range are 3.33-3.51, 3.51-3.68, 3.68-3.86, 3.86-4.04, 4.04-4.22, 4.22-4.39, 4.39-4.57)
7341-4S	4.57-5.79mm	1 pc	6 pairs (the clamping range are 4.57-4.78, 4.78-4.98, 4.98-5.18, 5.18-5.38, 5.38-5.59, 5.59-5.79)
7341-5S	5.79-7.14mm	1 pc	6 pairs (the clamping range are 5.79-5.99, 5.99-6.20, 6.20-6.40, 6.40-6.63, 6.63-6.88, 6.88-7.14)

Code	Applicable pin gage diameter	Including	
		Handle	Clamping bush (mm)
7341-6S	7.14-8.66mm	1 pc	6 pairs (the clamping range are 7.14-7.39, 7.39-7.65, 7.65-7.90, 7.90-8.15, 8.15-8.41, 8.41-8.66)
7341-7S	8.66-10.31mm	1 pc	6 pairs (the clamping range are 8.66-8.92, 8.9 -9.17, 9.17-9.42, 9.42-9.70, 9.70-10.01, 10.01-10.31)
7341-8S	10.31-11.81mm	1 pc	4 pairs (the clamping range are 10.31-10.67, 10.67-11.05, 11.05-11.43, 11.43-11.81)
7341-9S	11.81-12.95mm	1 pc	3 pairs (the clamping range are 11.81-12.19, 12.19-12.57, 12.57-12.95)
7341-10S	12.95-14.71mm	1 pc	4 pairs (the clamping range are 12.95-13.51, 13.51-13.89, 13.89-14.30, 14.30-14.71)
7341-11S	14.71-16.13mm	1 pc	4 pairs (the clamping range are 14.71-15.09, 15.09-15.49, 15.49-15.88, 15.88-16.13)
7341-12S	16.13-17.88mm	1 pc	4 pairs (the clamping range are 16.13-16.66, 16.66-17.07, 17.07-17.48, 17.48-17.88)
7341-13S	17.88-19.30mm	1 pc	4 pairs (the clamping range are 17.88-18.26, 18.26-18.67, 18.67-19.05, 19.05-19.30)
7341-15S	19.30-25.65mm	1 pc	8 pairs (the clamping range are 19.30-19.84, 19.84-20.62, 20.62-21.41, 21.41-22.23, 22.23-23.03, 23.03-23.80, 23.80-24.59, 24.59-25.65)

SETTING RINGS

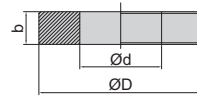
CAN SUPPLY CUSTOM SETTING RINGS FROM Ø1.500MM TO Ø315.000MM, FOR EXAMPLE, Ø17.085MM



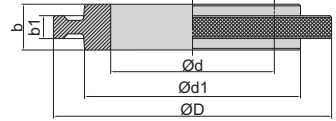
- For zero setting of inside micrometers, three points internal micrometers and bore gages
- Deviation (difference between the ordered size and the size marked on the setting ring when supplied): For example, the ordered size is Ø10.125mm, the size marked on the setting ring when supplied may be Ø10.127mm
- Meet DIN2250-1:2008



6312-20



Ø1.5mm-100mm



Ø100mm-315mm

(mm)				
Diameter d**	b	D	Deviation	Roundness and cylindricity
Ø1.5-2.5	4	22	±10.0µm	0.3µm
Ø2.5-3	5	22	±10.0µm	0.3µm
Ø3-5	5	22	±10.0µm	0.4µm
Ø5-10	8	32	±10.0µm	0.4µm
Ø10-15	10	38	±10.0µm	0.5µm
Ø15-18	12	45	±10.0µm	0.5µm
Ø18-20	12	45	±10.0µm	0.6µm
Ø20-25	14	53	±10.0µm	0.6µm
Ø25-30	16	63	±10.0µm	0.6µm
Ø30-32	16	63	±10.0µm	0.7µm
Ø32-40	18	71	±10.0µm	0.7µm
Ø40-50	20	85	±10.0µm	0.7µm
Ø50-60	20	100	±10.0µm	0.8µm
Ø60-70	24	112	±10.0µm	0.8µm
Ø70-80	24	125	±10.0µm	0.8µm
Ø80-90	24	140	±10.0µm	1.0µm
Ø90-100	24	160	±10.0µm	1.0µm

(mm)						
Diameter d**	b	b1	d1	D	Deviation	Roundness and cylindricity
Ø100-110	28	14	132	170	±10.0µm	1.0µm
Ø110-120	28	16	140	180	±10.0µm	1.0µm
Ø120-130	28	16	150	190	±10.0µm	1.2µm
Ø130-140	28	18	160	200	±10.0µm	1.2µm
Ø140-150	28	18	170	212	±10.0µm	1.2µm
Ø150-160	28	20	180	224	±10.0µm	1.2µm
Ø160-170	32	20	190	236	±10.0µm	1.2µm
Ø170-180	32	20	200	250	±10.0µm	1.2µm
Ø180-190	32	22	212	265	±10.0µm	1.4µm
Ø190-200	32	22	224	280	±10.0µm	1.4µm
Ø200-212	32	22	236	300	±10.0µm	1.4µm
Ø212-224	32	25	250	315	±10.0µm	1.4µm
Ø224-236	36	25	265	335	±10.0µm	1.4µm
Ø236-250	36	28	280	355	±10.0µm	1.4µm
Ø250-265	36	28	300	375	±10.0µm	1.6µm
Ø265-280	36	28	315	400	±10.0µm	1.6µm
Ø280-300	36	32	335	425	±10.0µm	1.6µm
Ø300-315	36	32	355	450	±10.0µm	1.6µm

** For example Ø3-5mm means Ø3mm<diameter d≤Ø5mm

(mm)	
Code	Size
6312-1D5*	Ø1.5
6312-2*	Ø2
6312-2D5*	Ø2.5
6312-3*	Ø3
6312-3D5*	Ø3.5
6312-4*	Ø4
6312-4D5*	Ø4.5
6312-5*	Ø5
6312-5D5*	Ø5.5
6312-6*	Ø6
6312-6D5*	Ø6.5
6312-7*	Ø7
6312-7D5*	Ø7.5
6312-8*	Ø8
6312-8D5*	Ø8.5
6312-9*	Ø9
6312-9D5*	Ø9.5
6312-10*	Ø10
6312-10D5*	Ø10.5
6312-11*	Ø11
6312-11D5*	Ø11.5
6312-12*	Ø12

(mm)	
Code	Size
6312-12D5*	Ø12.5
6312-13*	Ø13
6312-13D5*	Ø13.5
6312-14*	Ø14
6312-14D5*	Ø14.5
6312-15*	Ø15
6312-15D5*	Ø15.5
6312-16*	Ø16
6312-16D5*	Ø16.5
6312-17*	Ø17
6312-17D5*	Ø17.5
6312-18*	Ø18
6312-18D5*	Ø18.5
6312-19*	Ø19
6312-19D5*	Ø19.5
6312-20*	Ø20
6312-20D5*	Ø20.5
6312-21*	Ø21
6312-21D5*	Ø21.5
6312-22*	Ø22
6312-22D5*	Ø22.5
6312-23*	Ø23

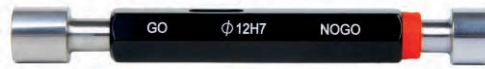
(mm)	
Code	Size
6312-23D5*	Ø23.5
6312-24*	Ø24
6312-24D5*	Ø24.5
6312-25*	Ø25
6312-25D5*	Ø25.5
6312-26*	Ø26
6312-26D5*	Ø26.5
6312-27*	Ø27
6312-27D5*	Ø27.5
6312-28*	Ø28
6312-28D5*	Ø28.5
6312-29*	Ø29
6312-29D5*	Ø29.5
6312-30*	Ø30
6312-31*	Ø31
6312-32*	Ø32
6312-33*	Ø33
6312-34*	Ø34
6312-35*	Ø35
6312-36*	Ø36
6312-37*	Ø37
6312-38*	Ø38

(mm)	
Code	Size
6312-39*	Ø39
6312-40*	Ø40
6312-41*	Ø41
6312-42*	Ø42
6312-43*	Ø43
6312-44*	Ø44
6312-45*	Ø45
6312-46*	Ø46
6312-47*	Ø47
6312-48*	Ø48
6312-49*	Ø49
6312-50*	Ø50
6312-55*	Ø55
6312-60*	Ø60
6312-62*	Ø62
6312-65*	Ø65
6312-70*	Ø70
6312-75*	Ø75
6312-80*	Ø80
6312-85*	Ø85
6312-87*	Ø87
6312-90*	Ø90

(mm)	
Code	Size
6312-95*	Ø95
6312-100*	Ø100
6312-112D5*	Ø112.5
6312-125*	Ø125
6312-137D5*	Ø137.5
6312-150*	Ø150
6312-162D5*	Ø162.5
6312-175*	Ø175
6312-187D5*	Ø187.5
6312-200*	Ø200
6312-212D5*	Ø212.5
6312-225*	Ø225
6312-237D5*	Ø237.5
6312-250*	Ø250
6312-262D5*	Ø262.5
6312-275*	Ø275
6312-287D5*	Ø287.5
6312-300*	Ø300

* Supplied with manufacturer inspection certificate

- Supplied with Go and No-Go gages together
- Class H7
- Hardness HRC 60±2
- Standard DIN7150-2



4124-12

PLAIN PLUG GAGES

CUSTOM-MADE

OTHER CLASSES ARE AVAILABLE, SUCH AS H8, H9
OTHER DIAMETERS ARE AVAILABLE, SUCH AS 19.003mm
OTHER LENGTHS ARE AVAILABLE, SUCH AS 70mm

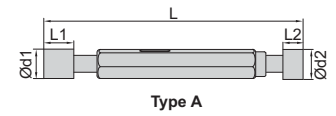
Size tolerance of H7

(mm)

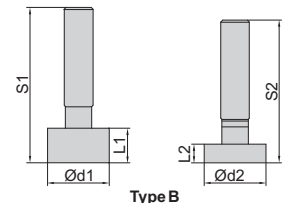
Diameter Ød	Type	Size tolerance of Go gage (µm)	Size tolerance of No-Go gage (µm)	L1	L2	L	S1, S2
≥2, ≤3	A	+0.5 / +2.5	+9 / +11	6.5	4.5	62	-
>3, ≤6	A	+0.75 / +3.25	+10.75 / +13.25	8	6	74	-
>6, ≤10	A	+0.75 / +3.25	+13.75 / +16.25	10	7	87	-
>10, ≤14	A	+1 / +4	+16.5 / +19.5	12	8	99	-
>14, ≤18	A	+1 / +4	+16.5 / +19.5	14	10	114	-
>18, ≤24	A	+1 / +5	+19 / +23	16	12	132	-
>24, ≤30	A	+1 / +5	+19 / +23	18	14	136	-
>30, ≤40	A	+1.5 / +5.5	+23 / +27	20	15	155	-
>40, ≤50	A	+1.5 / +5.5	+23 / +27	25	18	169	-
>50, ≤65	B	+1.5 / +6.5	+27.5 / +32.5	30	18	-	164, 152
>65, ≤80	B	+1.5 / +6.5	+27.5 / +32.5	35	25	-	169, 159
>80, ≤100	B	+2 / +8	+32 / +38	35	25	-	169, 159



Type A



Type B



Code	Diameter	Type	Code	Diameter	Type	Code	Diameter	Type	Code	Diameter	Type
4124-2	2mm	A	4124-17	17mm	A	4124-32	32mm	A	4124-47	47mm	A
4124-3	3mm	A	4124-18	18mm	A	4124-33	33mm	A	4124-48	48mm	A
4124-4	4mm	A	4124-19	19mm	A	4124-34	34mm	A	4124-49	49mm	A
4124-5	5mm	A	4124-20	20mm	A	4124-35	35mm	A	4124-50	50mm	A
4124-6	6mm	A	4124-21	21mm	A	4124-36	36mm	A	4124-52	52mm	B
4124-7	7mm	A	4124-22	22mm	A	4124-37	37mm	A	4124-55	55mm	B
4124-8	8mm	A	4124-23	23mm	A	4124-38	38mm	A	4124-60	60mm	B
4124-9	9mm	A	4124-24	24mm	A	4124-39	39mm	A	4124-65	65mm	B
4124-10	10mm	A	4124-25	25mm	A	4124-40	40mm	A	4124-70	70mm	B
4124-11	11mm	A	4124-26	26mm	A	4124-41	41mm	A	4124-75	75mm	B
4124-12	12mm	A	4124-27	27mm	A	4124-42	42mm	A	4124-80	80mm	B
4124-13	13mm	A	4124-28	28mm	A	4124-43	43mm	A	4124-85	85mm	B
4124-14	14mm	A	4124-29	29mm	A	4124-44	44mm	A	4124-90	90mm	B
4124-15	15mm	A	4124-30	30mm	A	4124-45	45mm	A	4124-95	95mm	B
4124-16	16mm	A	4124-31	31mm	A	4124-46	46mm	A	4124-100	100mm	B



- Supplied with Go and No-Go gages together
- Standard ISO1502
- Supplied with manufacturer inspection certificate



4130-10

METRIC THREAD PLUG GAGES

ATTENTION:
LIFE TIME IS LIMITED

Size (mm)		Code (4130)		
Nominal diameter	Pitch	Class 6H	Class 6G	Class 4H
M0.8	0.2	-D8	-D8G	-D8H
M0.9	0.225	-D9	-D9G	-D9H
M1	0.25	-1	-1G	-1H
M1.1	0.25	-1D1	-1D1G	-1D1H
M1.2	0.25	-1D2	-1D2G	-1D2H
M1.4	0.3	-1D4	-1D4G	-1D4H
M1.6	0.35	-1D6	-1D6G	-1D6H
M1.7	0.35	-1D7	-1D7G	-1D7H
M1.8	0.35	-1D8	-1D8G	-1D8H
M2	0.4	-2	-2G	-2H
M2.2	0.45	-2D2	-2D2G	-2D2H
M2.3	0.4	-2D3	-2D3G	-2D3H
M2.5	0.45	-2D5	-2D5G	-2D5H
M2.6	0.45	-2D6	-2D6G	-2D6H
M3	0.5	-3	-3G	-3H

Size (mm)		Code (4130)		
Nominal diameter	Pitch	Class 6H	Class 6G	Class 4H
M3.5	0.6	-3D5	-3D5G	5H
M4	0.7	-4	-4G	-4H
M4.5	0.75	-4D5	-4D5G	-4D5H
M5	0.8	-5	-5G	-5H
M6	1	-6	-6G	-6H
M7	1	-7	-7G	-7H
M8	1.25	-8	-8G	-8H
M9	1.25	-9	-9G	-9H
M10	1.5	-10	-10G	-10H
M11	1.5	-11	-11G	-11H
M12	1.75	-12	-12G	-12H
M14	2	-14	-14G	-14H
M16	2	-16	-16G	-16H
M18	2.5	-18	-18G	-18H
M20	2.5	-20	-20G	-20H

Code example:
"-D8" stands for "4130-D8"

Size (mm)		Code (4130)		
Nominal diameter	Pitch	Class 6H	Class 6G	Class 4H
M22	2.5	-22	-22G	-22H
M24	3	-24	-24G	-24H
M27	3	-27	-27G	-27H
M30	3.5	-30	-30G	-30H
M33	3.5	-33	-33G	-33H
M36	4	-36	-36G	-36H
M39	4	-39	-39G	-39H
M42	4.5	-42	-42G	-42H
M45	4.5	-45	-45G	-45H
M48	5	-48	-48G	-48H
M52	5	-52	-52G	-52H
M56	5.5	-56	-56G	-56H
M60	5.5	-60	-60G	-60H

METRIC FINE THREAD PLUG GAGES



ATTENTION:
LIFE TIME IS LIMITED



4139-20G

- Supplied with Go and No-Go gages together
- Standard ISO1502
- Supplied with manufacturer inspection certificate

Code example:
"-1A" stands for "4139-1A"

9

Size (mm)		Code (4139)		
Nominal diameter	Pitch	Class 6H	Class 6G	Class 4H
M1	0.2	-1A	-1AG	-1AH
M1.2	0.2	-1D2A	-1D2AG	-1D2AH
M1.4	0.2	-1D4A	-1D4AG	-1D4AH
M1.6	0.2	-1D6A	-1D6AG	-1D6AH
M1.8	0.2	-1D8A	-1D8AG	-1D8AH
M2	0.2	-2A	-2AG	-2AH
	0.25	-2B	-2BG	-2BH
M2.5	0.2	-2D5A	-2D5AG	-2D5AH
	0.25	-2D5B	-2D5BG	-2D5BH
	0.35	-2D5D	-2D5DG	-2D5DH
M3	0.25	-3B	-3BG	-3BH
	0.35	-3D	-3DG	-3DH
M3.5	0.25	-3D5B	-3D5BG	-3D5BH
	0.35	-3D5D	-3D5DG	-3D5DH
	0.5	-3D5G	-3D5GG	-3D5GH
M4	0.25	-4B	-4BG	-4BH
	0.35	-4D	-4DG	-4DH
	0.5	-4G	-4GG	-4GH
M4.5	0.35	-4D5D	-4D5DG	-4D5DH
	0.5	-4D5G	-4D5GG	-4D5GH
M5	0.25	-5B	-5BG	-5BH
	0.35	-5D	-5DG	-5DH
	0.5	-5G	-5GG	-5GH
M5.5	0.5	-5D5G	-5D5GG	-5D5GH
M6	0.25	-6B	-6BG	-6BH
	0.35	-6D	-6DG	-6DH
	0.5	-6G	-6GG	-6GH
M6.5	0.5	-6D5G	-6D5GG	-6D5GH
M7	0.35	-7D	-7DG	-7DH
	0.5	-7G	-7GG	-7GH
M7.5	0.5	-7D5G	-7D5GG	-7D5GH
M8	0.35	-8D	-8DG	-8DH
	0.5	-8G	-8GG	-8GH
	1	-8P	-8PG	-8PH
M8.5	0.5	-8D5G	-8D5GG	-8D5GH
M9	0.35	-9D	-9DG	-9DH
	0.5	-9G	-9GG	-9GH
	0.75	-9L	-9LG	-9LH
	1	-9P	-9PG	-9PH
M10	0.35	-10D	-10DG	-10DH
	0.5	-10G	-10GG	-10GH
	1	-10P	-10PG	-10PH
	1.25	-10Q	-10QG	-10QH
M11	0.5	-11G	-11GG	-11GH
	1	-11P	-11PG	-11PH

Size (mm)		Code (4139)		
Nominal diameter	Pitch	Class 6H	Class 6G	Class 4H
M12	0.5	-12G	-12GG	-12GH
	1	-12P	-12PG	-12PH
	1.25	-12Q	-12QG	-12QH
	1.5	-12R	-12RG	-12RH
M13	0.5	-13G	-13GG	-13GH
	1	-13P	-13PG	-13PH
	1.5	-13R	-13RG	-13RH
M14	0.5	-14G	-14GG	-14GH
	1	-14P	-14PG	-14PH
	1.25	-14Q	-14QG	-14QH
	1.5	-14R	-14RG	-14RH
M15	0.5	-15G	-15GG	-15GH
	1	-15P	-15PG	-15PH
	1.5	-15R	-15RG	-15RH
M16	0.5	-16G	-16GG	-16GH
	1	-16P	-16PG	-16PH
	1.25	-16Q	-16QG	-16QH
	1.5	-16R	-16RG	-16RH
M17	0.5	-17G	-17GG	-17GH
	1	-17P	-17PG	-17PH
	1.5	-17R	-17RG	-17RH
M18	0.5	-18G	-18GG	-18GH
	1	-18P	-18PG	-18PH
	1.25	-18Q	-18QG	-18QH
	1.5	-18R	-18RG	-18RH
	2	-18T	-18TG	-18TH
M19	0.5	-19G	-19GG	-19GH
	1	-19P	-19PG	-19PH
	1.5	-19R	-19RG	-19RH
M20	0.5	-20G	-20GG	-20GH
	1	-20P	-20PG	-20PH
	1.25	-20Q	-20QG	-20QH
	1.5	-20R	-20RG	-20RH
	2	-20T	-20TG	-20TH
M21	0.5	-21G	-21GG	-21GH
	1	-21P	-21PG	-21PH
	1.5	-21R	-21RG	-21RH
	0.5	-22G	-22GG	-22GH
M22	1	-22P	-22PG	-22PH
	1.25	-22Q	-22QG	-22QH
	1.5	-22R	-22RG	-22RH
	2	-22T	-22TG	-22TH
M23	0.5	-23G	-23GG	-23GH
	1	-23P	-23PG	-23PH

To be continued

Continued from previous page

Size (mm)		Code (4139)		
Nominal diameter	Pitch	Class 6H	Class 6G	Class 4H
M24	0.5	-24G	-24GG	-24GH
	1	-24P	-24PG	-24PH
	1.25	-24Q	-24QG	-24QH
	1.5	-24R	-24RG	-24RH
	2	-24T	-24TG	-24TH
M25	0.5	-25G	-25GG	-25GH
	1	-25P	-25PG	-25PH
	1.5	-25R	-25RG	-25RH
	2	-25T	-25TG	-25TH
M26	0.5	-26G	-26GG	-26GH
	1	-26P	-26PG	-26PH
	1.5	-26R	-26RG	-26RH
	2	-26T	-26TG	-26TH
M27	0.5	-27G	-27GG	-27GH
	1	-27P	-27PG	-27PH
	1.5	-27R	-27RG	-27RH
	2	-27T	-27TG	-27TH
M28	0.5	-28G	-28GG	-28GH
	1	-28P	-28PG	-28PH
	1.5	-28R	-28RG	-28RH
M29	0.5	-29G	-29GG	-29GH
	0.75	-29L	-29LG	-29LH
	1	-29P	-29PG	-29PH
M30	0.5	-30G	-30GG	-30GH
	0.75	-30L	-30LG	-30LH
	1	-30P	-30PG	-30PH
	1.5	-30R	-30RG	-30RH
	2	-30T	-30TG	-30TH
M31	0.5	-31G	-31GG	-31GH
	0.75	-31L	-31LG	-31LH
	0.5	-32G	-32GG	-32GH
M32	0.75	-32L	-32LG	-32LH
	1	-32P	-32PG	-32PH
	1.5	-32R	-32RG	-32RH
	2	-32T	-32TG	-32TH
	M33	0.5	-33G	-33GG
0.75		-33L	-33LG	-33LH
1		-33P	-33PG	-33PH
1.5		-33R	-33RG	-33RH
2		-33T	-33TG	-33TH
3		-33V	-33VG	-33VH
M34	0.75	-34L	-34LG	-34LH
	1	-34P	-34PG	-34PH
	1.5	-34R	-34RG	-34RH
	2	-34T	-34TG	-34TH
M35	0.75	-35L	-35LG	-35LH
	1	-35P	-35PG	-35PH
	1.5	-35R	-35RG	-35RH
	2	-35T	-35TG	-35TH
M36	0.75	-36L	-36LG	-36LH
	1	-36P	-36PG	-36PH
	1.5	-36R	-36RG	-36RH
	2	-36T	-36TG	-36TH
	3	-36V	-36VG	-36VH
M37	0.75	-37L	-37LG	-37LH

Size (mm)		Code (4139)		
Nominal diameter	Pitch	Class 6H	Class 6G	Class 4H
M38	0.75	-38L	-38LG	-38LH
	1	-38P	-38PG	-38PH
	1.5	-38R	-38RG	-38RH
	2	-38T	-38TG	-38TH
M39	0.75	-39L	-39LG	-39LH
	1	-39P	-39PG	-39PH
	1.5	-39R	-39RG	-39RH
	2	-39T	-39TG	-39TH
M40	3	-39V	-39VG	-39VH
	0.75	-40L	-40LG	-40LH
	1	-40P	-40PG	-40PH
M42	1.5	-40R	-40RG	-40RH
	2	-40T	-40TG	-40TH
	3	-40V	-40VG	-40VH
M45	1	-42P	-42PG	-42PH
	1.5	-42R	-42RG	-42RH
	2	-42T	-42TG	-42TH
M48	3	-42V	-42VG	-42VH
	1	-45P	-45PG	-45PH
	1.5	-45R	-45RG	-45RH
M50	2	-45T	-45TG	-45TH
	3	-45V	-45VG	-45VH
	1	-48P	-48PG	-48PH
M52	1.5	-48R	-48RG	-48RH
	2	-48T	-48TG	-48TH
	3	-48V	-48VG	-48VH
M55	1	-50P	-50PG	-50PH
	1.5	-50R	-50RG	-50RH
	2	-50T	-50TG	-50TH
	3	-50V	-50VG	-50VH
M56	1	-52P	-52PG	-52PH
	1.5	-52R	-52RG	-52RH
	2	-52T	-52TG	-52TH
	3	-52V	-52VG	-52VH
M58	4	-52X	-52XG	-52XH
	1	-55P	-55PG	-55PH
	1.5	-55R	-55RG	-55RH
	2	-55T	-55TG	-55TH
M60	3	-55V	-55VG	-55VH
	4	-55X	-55XG	-55XH
	1	-56P	-56PG	-56PH
	1.5	-56R	-56RG	-56RH
M60	2	-56T	-56TG	-56TH
	3	-56V	-56VG	-56VH
	4	-56X	-56XG	-56XH
	1	-58P	-58PG	-58PH
M60	1.5	-58R	-58RG	-58RH
	2	-58T	-58TG	-58TH
	3	-58V	-58VG	-58VH
	4	-58X	-58XG	-58XH
M60	1	-60P	-60PG	-60PH
	1.5	-60R	-60RG	-60RH
	2	-60T	-60TG	-60TH
	3	-60V	-60VG	-60VH
M60	4	-60X	-60XG	-60XH

METRIC THREAD RING GAGES



ATTENTION:
LIFE TIME IS LIMITED



4120-16



4120-16N

- Standard ISO1502
- Supplied with manufacturer inspection certificate

Code example:
"-2" stands for "4120-2"

9

Size (mm)		Code (4120)					
Nominal diameter	Pitch	Class 6g		Class 6e		Class 6h	
		GO	NOGO	GO	NOGO	GO	NOGO
M2	0.4	-2	-2N	-2E	-2EN	-2H	-2HN
M2.2	0.45	-2D2	-2D2N	-2D2E	-2D2EN	-2D2H	-2D2HN
M2.3	0.4	-2D3	-2D3N	-2D3E	-2D3EN	-2D3H	-2D3HN
M2.5	0.45	-2D5	-2D5N	-2D5E	-2D5EN	-2D5H	-2D5HN
M2.6	0.45	-2D6	-2D6N	-2D6E	-2D6EN	-2D6H	-2D6HN
M3	0.5	-3	-3N	-3E	-3EN	-3H	-3HN
M3.5	0.6	-3D5	-3D5N	-3D5E	-3D5EN	-3D5H	-3D5HN
M4	0.7	-4	-4N	-4E	-4EN	-4H	-4HN
M4.5	0.75	-4D5	-4D5N	-4D5E	-4D5EN	-4D5H	-4D5HN
M5	0.8	-5	-5N	-5E	-5EN	-5H	-5HN
M6	1	-6	-6N	-6E	-6EN	-6H	-6HN
M7	1	-7	-7N	-7E	-7EN	-7H	-7HN
M8	1.25	-8	-8N	-8E	-8EN	-8H	-8HN
M9	1.25	-9	-9N	-9E	-9EN	-9H	-9HN
M10	1.5	-10	-10N	-10E	-10EN	-10H	-10HN
M11	1.5	-11	-11N	-11E	-11EN	-11H	-11HN
M12	1.75	-12	-12N	-12E	-12EN	-12H	-12HN
M14	2	-14	-14N	-14E	-14EN	-14H	-14HN
M16	2	-16	-16N	-16E	-16EN	-16H	-16HN
M18	2.5	-18	-18N	-18E	-18EN	-18H	-18HN
M20	2.5	-20	-20N	-20E	-20EN	-20H	-20HN
M22	2.5	-22	-22N	-22E	-22EN	-22H	-22HN
M24	3	-24	-24N	-24E	-24EN	-24H	-24HN
M27	3	-27	-27N	-27E	-27EN	-27H	-27HN
M30	3.5	-30	-30N	-30E	-30EN	-30H	-30HN
M33	3.5	-33	-33N	-33E	-33EN	-33H	-33HN
M36	4	-36	-36N	-36E	-36EN	-36H	-36HN
M39	4	-39	-39N	-39E	-39EN	-39H	-39HN
M42	4.5	-42	-42N	-42E	-42EN	-42H	-42HN
M45	4.5	-45	-45N	-45E	-45EN	-45H	-45HN
M48	5	-48	-48N	-48E	-48EN	-48H	-48HN
M52	5	-52	-52N	-52E	-52EN	-52H	-52HN
M56	5.5	-56	-56N	-56E	-56EN	-56H	-56HN
M60	5.5	-60	-60N	-60E	-60EN	-60H	-60HN

ATTENTION:
LIFE TIME IS LIMITED



METRIC FINE THREAD RING GAGES



4129-10P

4129-10PN

- Standard ISO1502
- Supplied with manufacturer inspection certificate

Code example:
“-2D5D” stands for “4129-2D5D”

Size (mm)		Code (4129)					
		Class 6g		Class 6e		Class 6h	
Nominal diameter	Pitch	GO	NOGO	GO	NOGO	GO	NOGO
M2.5	0.35	-2D5D	-2D5DN	-2D5DE	-2D5DEN	-2D5DH	-2D5DHN
M3	0.35	-3D	-3DN	-3DE	-3DEN	-3DH	-3DHN
M3.5	0.35	-3D5D	-3D5DN	-3D5DE	-3D5DEN	-3D5DH	-3D5DHN
	0.5	-3D5G	-3D5GN	-3D5GE	-3D5GEN	-3D5GH	-3D5GHN
M4	0.35	-4D	-4DN	-4DE	-4DEN	-4DH	-4DHN
	0.5	-4G	-4GN	-4GE	-4GEN	-4GH	-4GHN
M4.5	0.35	-4D5D	-4D5DN	-4D5DE	-4D5DEN	-4D5DH	-4D5DHN
	0.5	-4D5G	-4D5GN	-4D5GE	-4D5GEN	-4D5GH	-4D5GHN
M5	0.35	-5D	-5DN	-5DE	-5DEN	-5DH	-5DHN
	0.5	-5G	-5GN	-5GE	-5GEN	-5GH	-5GHN
M5.5	0.5	-5D5G	-5D5GN	-5D5GE	-5D5GEN	-5D5GH	-5D5GHN
	0.35	-6D	-6DN	-6DE	-6DEN	-6DH	-6DHN
M6	0.5	-6G	-6GN	-6GE	-6GEN	-6GH	-6GHN
	0.75	-6L	-6LN	-6LE	-6LEN	-6LH	-6LHN
M6.5	0.5	-6D5G	-6D5GN	-6D5GE	-6D5GEN	-6D5GH	-6D5GHN
	0.35	-7D	-7DN	-7DE	-7DEN	-7DH	-7DHN
M7	0.5	-7G	-7GN	-7GE	-7GEN	-7GH	-7GHN
	0.75	-7L	-7LN	-7LE	-7LEN	-7LH	-7LHN
M7.5	0.5	-7D5G	-7D5GN	-7D5GE	-7D5GEN	-7D5GH	-7D5GHN
	0.35	-8D	-8DN	-8DE	-8DEN	-8DH	-8DHN
M8	0.5	-8G	-8GN	-8GE	-8GEN	-8GH	-8GHN
	0.75	-8L	-8LN	-8LE	-8LEN	-8LH	-8LHN
	1	-8P	-8PN	-8PE	-8PEN	-8PH	-8PHN
M8.5	0.5	-8D5G	-8D5GN	-8D5GE	-8D5GEN	-8D5GH	-8D5GHN
	0.35	-9D	-9DN	-9DE	-9DEN	-9DH	-9DHN
M9	0.5	-9G	-9GN	-9GE	-9GEN	-9GH	-9GHN
	0.75	-9L	-9LN	-9LE	-9LEN	-9LH	-9LHN
	1	-9P	-9PN	-9PE	-9PEN	-9PH	-9PHN
M10	0.35	-10D	-10DN	-10DE	-10DEN	-10DH	-10DHN
	0.5	-10G	-10GN	-10GE	-10GEN	-10GH	-10GHN
	0.75	-10L	-10LN	-10LE	-10LEN	-10LH	-10LHN
	1	-10P	-10PN	-10PE	-10PEN	-10PH	-10PHN
M11	1.25	-10Q	-10QN	-10QE	-10QEN	-10QH	-10QHN
	0.5	-11G	-11GN	-11GE	-11GEN	-11GH	-11GHN
	0.75	-11L	-11LN	-11LE	-11LEN	-11LH	-11LHN
	1	-11P	-11PN	-11PE	-11PEN	-11PH	-11PHN
M12	1.25	-11Q	-11QN	-11QE	-11QEN	-11QH	-11QHN
	0.5	-12G	-12GN	-12GE	-12GEN	-12GH	-12GHN
	0.75	-12L	-12LN	-12LE	-12LEN	-12LH	-12LHN
	1	-12P	-12PN	-12PE	-12PEN	-12PH	-12PHN
M13	1.25	-12Q	-12QN	-12QE	-12QEN	-12QH	-12QHN
	1.5	-12R	-12RN	-12RE	-12REN	-12RH	-12RHN
	0.5	-13G	-13GN	-13GE	-13GEN	-13GH	-13GHN
M13	0.75	-13L	-13LN	-13LE	-13LEN	-13LH	-13LHN
	1	-13P	-13PN	-13PE	-13PEN	-13PH	-13PHN
	1.5	-13R	-13RN	-13RE	-13REN	-13RH	-13RHN

To be continued

Continued from previous page

Size (mm)		Code (4129)					
Nominal diameter	Pitch	Class 6g		Class 6e		Class 6h	
		GO	NOGO	GO	NOGO	GO	NOGO
M14	0.5	-14G	-14GN	-14GE	-14GEN	-14GH	-14GHN
	0.75	-14L	-14LN	-14LE	-14LEN	-14LH	-14LHN
	1	-14P	-14PN	-14PE	-14PEN	-14PH	-14PHN
	1.25	-14Q	-14QN	-14QE	-14QEN	-14QH	-14QHN
	1.5	-14R	-14RN	-14RE	-14REN	-14RH	-14RHN
M15	0.5	-15G	-15GN	-15GE	-15GEN	-15GH	-15GHN
	0.75	-15L	-15LN	-15LE	-15LEN	-15LH	-15LHN
	1	-15P	-15PN	-15PE	-15PEN	-15PH	-15PHN
	1.5	-15R	-15RN	-15RE	-15REN	-15RH	-15RHN
M16	0.5	-16G	-16GN	-16GE	-16GEN	-16GH	-16GHN
	0.75	-16L	-16LN	-16LE	-16LEN	-16LH	-16LHN
	1	-16P	-16PN	-16PE	-16PEN	-16PH	-16PHN
	1.25	-16Q	-16QN	-16QE	-16QEN	-16QH	-16QHN
	1.5	-16R	-16RN	-16RE	-16REN	-16RH	-16RHN
M17	0.5	-17G	-17GN	-17GE	-17GEN	-17GH	-17GHN
	0.75	-17L	-17LN	-17LE	-17LEN	-17LH	-17LHN
	1	-17P	-17PN	-17PE	-17PEN	-17PH	-17PHN
	1.5	-17R	-17RN	-17RE	-17REN	-17RH	-17RHN
M18	0.5	-18G	-18GN	-18GE	-18GEN	-18GH	-18GHN
	0.75	-18L	-18LN	-18LE	-18LEN	-18LH	-18LHN
	1	-18P	-18PN	-18PE	-18PEN	-18PH	-18PHN
	1.25	-18Q	-18QN	-18QE	-18QEN	-18QH	-18QHN
	1.5	-18R	-18RN	-18RE	-18REN	-18RH	-18RHN
	2	-18T	-18TN	-18TE	-18TEN	-18TH	-18THN
M19	0.5	-19G	-19GN	-19GE	-19GEN	-19GH	-19GHN
	0.75	-19L	-19LN	-19LE	-19LEN	-19LH	-19LHN
	1	-19P	-19PN	-19PE	-19PEN	-19PH	-19PHN
	1.5	-19R	-19RN	-19RE	-19REN	-19RH	-19RHN
M20	0.5	-20G	-20GN	-20GE	-20GEN	-20GH	-20GHN
	0.75	-20L	-20LN	-20LE	-20LEN	-20LH	-20LHN
	1	-20P	-20PN	-20PE	-20PEN	-20PH	-20PHN
	1.25	-20Q	-20QN	-20QE	-20QEN	-20QH	-20QHN
	1.5	-20R	-20RN	-20RE	-20REN	-20RH	-20RHN
M21	0.75	-20T	-20TN	-20TE	-20TEN	-20TH	-20THN
	0.75	-21L	-21LN	-21LE	-21LEN	-21LH	-21LHN
	1	-21P	-21PN	-21PE	-21PEN	-21PH	-21PHN
	1.5	-21R	-21RN	-21RE	-21REN	-21RH	-21RHN
M22	0.75	-22L	-22LN	-22LE	-22LEN	-22LH	-22LHN
	1	-22P	-22PN	-22PE	-22PEN	-22PH	-22PHN
	1.25	-22Q	-22QN	-22QE	-22QEN	-22QH	-22QHN
	1.5	-22R	-22RN	-22RE	-22REN	-22RH	-22RHN
	2	-22T	-22TN	-22TE	-22TEN	-22TH	-22THN
M23	0.75	-23L	-23LN	-23LE	-23LEN	-23LH	-23LHN
	1	-23P	-23PN	-23PE	-23PEN	-23PH	-23PHN
M24	0.75	-24L	-24LN	-24LE	-24LEN	-24LH	-24LHN
	1	-24P	-24PN	-24PE	-24PEN	-24PH	-24PHN
	1.25	-24Q	-24QN	-24QE	-24QEN	-24QH	-24QHN
	1.5	-24R	-24RN	-24RE	-24REN	-24RH	-24RHN
M25	2	-24T	-24TN	-24TE	-24TEN	-24TH	-24THN
	0.75	-25L	-25LN	-25LE	-25LEN	-25LH	-25LHN
	1	-25P	-25PN	-25PE	-25PEN	-25PH	-25PHN
	1.5	-25R	-25RN	-25RE	-25REN	-25RH	-25RHN
M26	2	-25T	-25TN	-25TE	-25TEN	-25TH	-25THN
	0.75	-26L	-26LN	-26LE	-26LEN	-26LH	-26LHN
	1	-26P	-26PN	-26PE	-26PEN	-26PH	-26PHN
M26	1.5	-26R	-26RN	-26RE	-26REN	-26RH	-26RHN
	2	-26T	-26TN	-26TE	-26TEN	-26TH	-26THN

To be continued

Continued from previous page

Size (mm)		Code (4129)					
Nominal diameter	Pitch	Class 6g		Class 6e		Class 6h	
		GO	NOGO	GO	NOGO	GO	NOGO
M27	0.75	-27L	-27LN	-27LE	-27LEN	-27LH	-27LHN
	1	-27P	-27PN	-27PE	-27PEN	-27PH	-27PHN
	1.5	-27R	-27RN	-27RE	-27REN	-27RH	-27RHN
	2	-27T	-27TN	-27TE	-27TEN	-27TH	-27THN
M28	0.75	-28L	-28LN	-28LE	-28LEN	-28LH	-28LHN
	1	-28P	-28PN	-28PE	-28PEN	-28PH	-28PHN
	1.5	-28R	-28RN	-28RE	-28REN	-28RH	-28RHN
	2	-28T	-28TN	-28TE	-28TEN	-28TH	-28THN
M29	0.75	-29L	-29LN	-29LE	-29LEN	-29LH	-29LHN
	1	-29P	-29PN	-29PE	-29PEN	-29PH	-29PHN
M30	0.75	-30L	-30LN	-30LE	-30LEN	-30LH	-30LHN
	1	-30P	-30PN	-30PE	-30PEN	-30PH	-30PHN
	1.5	-30R	-30RN	-30RE	-30REN	-30RH	-30RHN
	2	-30T	-30TN	-30TE	-30TEN	-30TH	-30THN
M31	3	-30V	-30VN	-30VE	-30VEN	-30VH	-30VHN
	0.75	-31L	-31LN	-31LE	-31LEN	-31LH	-31LHN
M32	0.75	-32L	-32LN	-32LE	-32LEN	-32LH	-32LHN
	1	-32P	-32PN	-32PE	-32PEN	-32PH	-32PHN
	1.5	-32R	-32RN	-32RE	-32REN	-32RH	-32RHN
	2	-32T	-32TN	-32TE	-32TEN	-32TH	-32THN
M33	0.75	-33L	-33LN	-33LE	-33LEN	-33LH	-33LHN
	1	-33P	-33PN	-33PE	-33PEN	-33PH	-33PHN
	1.5	-33R	-33RN	-33RE	-33REN	-33RH	-33RHN
	2	-33T	-33TN	-33TE	-33TEN	-33TH	-33THN
	3	-33V	-33VN	-33VE	-33VEN	-33VH	-33VHN
M34	1	-34P	-34PN	-34PE	-34PEN	-34PH	-34PHN
	1.5	-34R	-34RN	-34RE	-34REN	-34RH	-34RHN
	2	-34T	-34TN	-34TE	-34TEN	-34TH	-34THN
M35	1	-35P	-35PN	-35PE	-35PEN	-35PH	-35PHN
	1.5	-35R	-35RN	-35RE	-35REN	-35RH	-35RHN
	2	-35T	-35TN	-35TE	-35TEN	-35TH	-35THN
M36	1	-36P	-36PN	-36PE	-36PEN	-36PH	-36PHN
	1.5	-36R	-36RN	-36RE	-36REN	-36RH	-36RHN
	2	-36T	-36TN	-36TE	-36TEN	-36TH	-36THN
	3	-36V	-36VN	-36VE	-36VEN	-36VH	-36VHN
M38	1	-38P	-38PN	-38PE	-38PEN	-38PH	-38PHN
	1.5	-38R	-38RN	-38RE	-38REN	-38RH	-38RHN
	2	-38T	-38TN	-38TE	-38TEN	-38TH	-38THN
M39	1	-39P	-39PN	-39PE	-39PEN	-39PH	-39PHN
	1.5	-39R	-39RN	-39RE	-39REN	-39RH	-39RHN
	2	-39T	-39TN	-39TE	-39TEN	-39TH	-39THN
	3	-39V	-39VN	-39VE	-39VEN	-39VH	-39VHN
M40	1.5	-40R	-40RN	-40RE	-40REN	-40RH	-40RHN
	2	-40T	-40TN	-40TE	-40TEN	-40TH	-40THN
	3	-40V	-40VN	-40VE	-40VEN	-40VH	-40VHN
M42	1.5	-42R	-42RN	-42RE	-42REN	-42RH	-42RHN
	2	-42T	-42TN	-42TE	-42TEN	-42TH	-42THN
	3	-42V	-42VN	-42VE	-42VEN	-42VH	-42VHN
M45	1.5	-45R	-45RN	-45RE	-45REN	-45RH	-45RHN
	2	-45T	-45TN	-45TE	-45TEN	-45TH	-45THN
	3	-45V	-45VN	-45VE	-45VEN	-45VH	-45VHN
M48	1.5	-48R	-48RN	-48RE	-48REN	-48RH	-48RHN
	2	-48T	-48TN	-48TE	-48TEN	-48TH	-48THN
	3	-48V	-48VN	-48VE	-48VEN	-48VH	-48VHN
M50	1.5	-50R	-50RN	-50RE	-50REN	-50RH	-50RHN
	2	-50T	-50TN	-50TE	-50TEN	-50TH	-50THN
	3	-50V	-50VN	-50VE	-50VEN	-50VH	-50VHN

To be continued

Continued from previous page

Size (mm)		Code (4129)					
Nominal diameter	Pitch	Class 6g		Class 6e		Class 6h	
		GO	NOGO	GO	NOGO	GO	NOGO
M52	1.5	-52R	-52RN	-52RE	-52REN	-52RH	-52RHN
	2	-52T	-52TN	-52TE	-52TEN	-52TH	-52THN
	3	-52V	-52VN	-52VE	-52VEN	-52VH	-52VHN
	4	-52X	-52XN	-52XE	-52XEN	-52XH	-52XHN
M55	1.5	-55R	-55RN	-55RE	-55REN	-55RH	-55RHN
	2	-55T	-55TN	-55TE	-55TEN	-55TH	-55THN
	3	-55V	-55VN	-55VE	-55VEN	-55VH	-55VHN
	4	-55X	-55XN	-55XE	-55XEN	-55XH	-55XHN
M56	1.5	-56R	-56RN	-56RE	-56REN	-56RH	-56RHN
	2	-56T	-56TN	-56TE	-56TEN	-56TH	-56THN
	3	-56V	-56VN	-56VE	-56VEN	-56VH	-56VHN
	4	-56X	-56XN	-56XE	-56XEN	-56XH	-56XHN
M58	1.5	-58R	-58RN	-58RE	-58REN	-58RH	-58RHN
	2	-58T	-58TN	-58TE	-58TEN	-58TH	-58THN
	3	-58V	-58VN	-58VE	-58VEN	-58VH	-58VHN
	4	-58X	-58XN	-58XE	-58XEN	-58XH	-58XHN
M60	1.5	-60R	-60RN	-60RE	-60REN	-60RH	-60RHN
	2	-60T	-60TN	-60TE	-60TEN	-60TH	-60THN
	3	-60V	-60VN	-60VE	-60VEN	-60VH	-60VHN
	4	-60X	-60XN	-60XE	-60XEN	-60XH	-60XHN

AMERICAN STANDARD THREAD PLUG GAGES

ATTENTION:
LIFE TIME IS LIMITED

- Supplied with Go and No-Go gages together
- Standard ANSI/ASME B1.2
- Supplied with manufacturer inspection certificate



4131-102

Size	Code		Size	Code		Size	Code	
	Class 2B	Class 3B		Class 2B	Class 3B		Class 2B	Class 3B
No. 0-80UNF	4131-02	4131-02B	5/16-18UNC	4131-5D1	4131-5D1B	13/16-20UNEF	4131-13D3	4131-13D3B
No. 1-64UNC	4131-11	4131-11B	5/16-24UNF	4131-5D2	4131-5D2B	7/8-9UNC	4131-7C1	4131-7C1B
No. 1-72UNF	4131-12	4131-12B	5/16-32UNEF	4131-5D3	4131-5D3B	7/8-14UNF	4131-7C2	4131-7C2B
No. 2-56UNC	4131-21	4131-21B	3/8-16UNC	4131-3C1	4131-3C1B	7/8-16UN	4131-7C516	4131-7C516B
No. 2-64UNF	4131-22	4131-22B	3/8-24UNF	4131-3C2	4131-3C2B	7/8-20UNEF	4131-7C3	4131-7C3B
No. 3-48UNC	4131-31	4131-31B	3/8-32UNEF	4131-3C3	4131-3C3B	15/16-20UNEF	4131-15D3	4131-15D3B
No. 3-56UNF	4131-32	4131-32B	7/16-14UNC	4131-7D1	4131-7D1B	1-8UNC	4131-2A1	4131-2A1B
No. 4-40UNC	4131-41	4131-41B	7/16-20UNF	4131-7D2	4131-7D2B	1-12UNF	4131-2A2	4131-2A2B
No. 4-48UNF	4131-42	4131-42B	7/16-28UNEF	4131-7D3	4131-7D3B	1-14UNS	4131-2A514	4131-2A514B
No. 5-40UNC	4131-51	4131-51B	1/2-13UNC	4131-1A1	4131-1A1B	1-20UNEF	4131-2A3	4131-2A3B
No. 5-44UNF	4131-52	4131-52B	1/2-20UNF	4131-1A2	4131-1A2B	1-32UN	4131-2A532	4131-2A532B
No. 6-32UNC	4131-61	4131-61B	1/2-28UNEF	4131-1A3	4131-1A3B	1 1/16-12UN	4131-1E512	4131-1E512B
No. 6-40UNF	4131-62	4131-62B	9/16-12UNC	4131-9D1	4131-9D1B	1 1/16-18UNEF	4131-1E3	4131-1E3B
No. 8-32UNC	4131-81	4131-81B	9/16-18UNF	4131-9D2	4131-9D2B	1 1/8-7UNC	4131-1F1	4131-1F1B
No. 8-36UNF	4131-82	4131-82B	9/16-24UNEF	4131-9D3	4131-9D3B	1 1/8-8UN	4131-1F58	4131-1F58B
No. 10-24UNC	4131-101	4131-101B	5/8-11UNC	4131-5C1	4131-5C1B	1 1/8-12UNF	4131-1F2	4131-1F2B
No. 10-32UNF	4131-102	4131-102B	5/8-18UNF	4131-5C2	4131-5C2B	1 1/8-18UNEF	4131-1F3	4131-1F3B
No. 12-24UNC	4131-121	4131-121B	5/8-24UNEF	4131-5C3	4131-5C3B	1 3/16-12UN	4131-3E512	4131-3E512B
No. 12-28UNF	4131-122	4131-122B	11/16-16UN	4131-11D516	4131-11D516B	1 3/16-18UNEF	4131-3E3	4131-3E3B
No. 12-32UNEF	4131-123	4131-123B	11/16-24UNEF	4131-11D3	4131-11D3B	1 1/4-7UNC	4131-1G1	4131-1G1B
1/4-20UNC	4131-1B1	4131-1B1B	3/4-10UNC	4131-3B1	4131-3B1B	1 1/4-8UN	4131-1G58	4131-1G58B
1/4-28UNF	4131-1B2	4131-1B2B	3/4-16UNF	4131-3B2	4131-3B2B	1 1/4-12UNF	4131-1G2	4131-1G2B
1/4-32UNEF	4131-1B3	4131-1B3B	3/4-20UNEF	4131-3B3	4131-3B3B	1 1/4-18UNEF	4131-1G3	4131-1G3B
1/4-36UNS	4131-1B4	4131-1B4B	13/16-16UN	4131-13D516	4131-13D516B	1 5/16-12UN	4131-5E512	4131-5E512B

ATTENTION:
LIFE TIME IS LIMITED



AMERICAN STANDARD THREAD RING GAGES

- Standard ANSI/ASME B1.2
- Class 2A
- Supplied with manufacturer inspection certificate

Size	Code	
	GO	NOGO
No. 4-40UNC	4121-41	4121-41N
No. 4-48UNF	4121-42	4121-42N
No. 5-40UNC	4121-51	4121-51N
No. 5-44UNF	4121-52	4121-52N
No. 6-32UNC	4121-61	4121-61N
No. 6-40UNF	4121-62	4121-62N
No. 8-32UNC	4121-81	4121-81N
No. 8-36UNF	4121-82	4121-82N
No. 10-24UNC	4121-101	4121-101N
No. 10-32UNF	4121-102	4121-102N
No. 12-24UNC	4121-121	4121-121N
No. 12-28UNF	4121-122	4121-122N
No. 12-32UNEF	4121-123	4121-123N
1/4-20UNC	4121-1B1	4121-1B1N
1/4-28UNF	4121-1B2	4121-1B2N
1/4-32UNEF	4121-1B3	4121-1B3N
1/4-36UNS	4121-1B4	4121-1B4N
5/16-18UNC	4121-5D1	4121-5D1N
5/16-24UNF	4121-5D2	4121-5D2N
5/16-32UNEF	4121-5D3	4121-5D3N
3/8-16UNC	4121-3C1	4121-3C1N
3/8-24UNF	4121-3C2	4121-3C2N

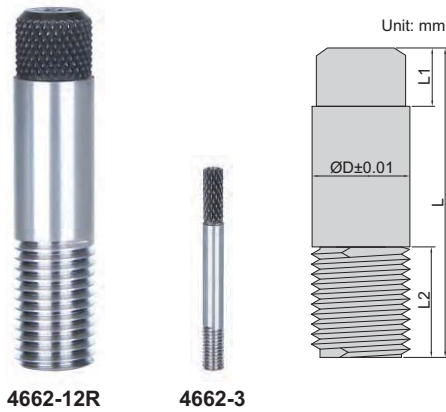


Size	Code	
	GO	NOGO
3/8-32UNEF	4121-3C3	4121-3C3N
7/16-14UNC	4121-7D1	4121-7D1N
7/16-20UNF	4121-7D2	4121-7D2N
7/16-28UNEF	4121-7D3	4121-7D3N
1/2-13UNC	4121-1A1	4121-1A1N
1/2-20UNF	4121-1A2	4121-1A2N
1/2-28UNEF	4121-1A3	4121-1A3N
9/16-12UNC	4121-9D1	4121-9D1N
9/16-18UNF	4121-9D2	4121-9D2N
9/16-24UNEF	4121-9D3	4121-9D3N
5/8-11UNC	4121-5C1	4121-5C1N
5/8-18UNF	4121-5C2	4121-5C2N
5/8-24UNEF	4121-5C3	4121-5C3N
11/16-16UN	4121-11D516	4121-11D516N
11/16-24UNEF	4121-11D3	4121-11D3N
3/4-10UNC	4121-3B1	4121-3B1N
3/4-16UNF	4121-3B2	4121-3B2N
3/4-20UNEF	4121-3B3	4121-3B3N
13/16-16UN	4121-13D516	4121-13D516N
13/16-20UNEF	4121-13D3	4121-13D3N
7/8-9UNC	4121-7C1	4121-7C1N
7/8-14UNF	4121-7C2	4121-7C2N

Size	Code	
	GO	NOGO
7/8-16UN	4121-7C516	4121-7C516N
7/8-20UNEF	4121-7C3	4121-7C3N
15/16-20UNEF	4121-15D3	4121-15D3N
1-8UNC	4121-2A1	4121-2A1N
1-12UNF	4121-2A2	4121-2A2N
1-14UNS	4121-2A514	4121-2A514N
1-20UNEF	4121-2A3	4121-2A3N
1-32UN	4121-2A532	4121-2A532N
1 1/16-12UN	4121-1E512	4121-1E512N
1 1/16-18UNEF	4121-1E3	4121-1E3N
1 1/8-7UNC	4121-1F1	4121-1F1N
1 1/8-8UN	4121-1F58	4121-1F58N
1 1/8-12UNF	4121-1F2	4121-1F2N
1 1/8-18UNEF	4121-1F3	4121-1F3N
1 3/16-12UN	4121-3E512	4121-3E512N
1 3/16-18UNEF	4121-3E3	4121-3E3N
1 1/4-7UNC	4121-1G1	4121-1G1N
1 1/4-8UN	4121-1G58	4121-1G58N
1 1/4-12UNF	4121-1G2	4121-1G2N
1 1/4-18UNEF	4121-1G3	4121-1G3N
1 5/16-12UN	4121-5E512	4121-5E512N

THREADED HOLE LOCATION GAGES

INSIZE PLUS
MADE IN EUROPE



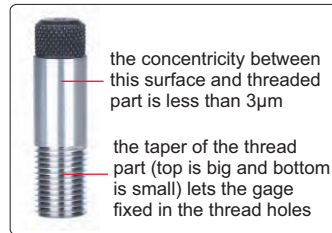
4662-12R

4662-3

■ Hardness: HRC60-63

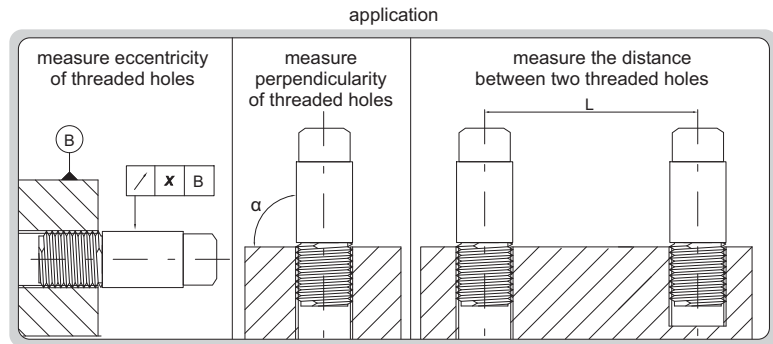
Metric thread (mm)

Code	Size	L	L1	L2	ØD
4662-3	M3×0.5-6H	29	8	6	3
4662-4	M4×0.7-6H	31.4	8	8.4	4
4662-5	M5×0.8-6H	32.6	8	9.6	5
4662-6	M6×1-6H	47	10	12	6
4662-8	M8×1.25-6H	50	10	15	8
4662-8P	M8×1-6H	47	10	12	8
4662-10	M10×1.5-6H	53	10	18	10
4662-10P	M10×1-6H	47	10	12	10
4662-12	M12×1.75-6H	56	10	21	12
4662-12P	M12×1-6H	47	10	12	12
4662-12R	M12×1.5-6H	53	10	18	12
4662-14	M14×2-6H	59	10	24	14
4662-14P	M14×1-6H	47	10	12	14
4662-14R	M14×1.5-6H	53	10	18	14
4662-16	M16×2-6H	59	10	24	16
4662-16P	M16×1-6H	47	10	12	16
4662-16R	M16×1.5-6H	53	10	18	16
4662-20	M20×2.5-6H	65	10	30	20
4662-20P	M20×1-6H	47	10	12	20
4662-20R	M20×1.5-6H	53	10	18	20



ANY SIZE WITHIN THE RANGE OF M3-M150MM CAN BE CUSTOMIZED

ACCURACY CLASS CAN BE CUSTOMIZED



American standard thread (mm)

Code	Size	L	L1	L2	ØD
4665-61	No.6-32UNC	32.5	8	9.5	3.505
4665-62	No.6-40UNF	30.6	8	7.6	3.505
4665-81	No.8-32UNC	32.5	8	9.5	4.166
4665-82	No.8-36UNF	31.5	8	8.5	4.166
4665-101	No.10-24UNC	35.7	8	12.7	4.826
4665-102	No.10-32UNF	32.5	8	9.5	4.826
4665-121	No.12-24UNC	47.7	10	12.7	5.486
4665-122	No.12-28UNF	45.9	10	10.9	5.486
4665-123	No.12-32UNEF	44.5	10	9.5	5.486
4665-1B1	1/4-20UNC	50.2	10	15.2	6.350
4665-1B2	1/4-28UNF	45.9	10	10.9	6.350
4665-1B3	1/4-32UNEF	44.5	10	9.5	6.350
4665-3C1	3/8-16UNC	54.1	10	19.1	9.525
4665-3C2	3/8-24UNF	47.7	10	12.7	9.525
4665-3C3	3/8-32UNEF	44.5	10	9.5	9.525
4665-1A1	1/2-13UNC	58.4	10	23.4	12.700
4665-1A2	1/2-20UNF	50.2	10	15.2	12.700
4665-1A3	1/2-28UNEF	45.9	10	10.9	12.700
4665-3B1	3/4-16UNC	54.1	10	19.1	19.050
4665-3B3	3/4-20UNEF	50.2	10	15.2	19.050

STEEL BALL SET

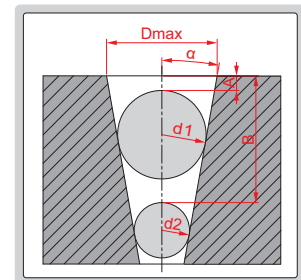
INSPECTION CERTIFICATE

- To measure angle and diameter of taper holes
- Each size has a pair of steel ball
- Material: tool steel
- Hardness: HRC63
- Diameter accuracy: $\pm 3\mu\text{m}$
- Roundness: $1\mu\text{m}$
- Supplied with manufacturer inspection certificate



4168-S25

Calculate angle (α) and diameter (D_{max}) according to the ball diameter (d_1 , d_2), height (A) and depth (B)



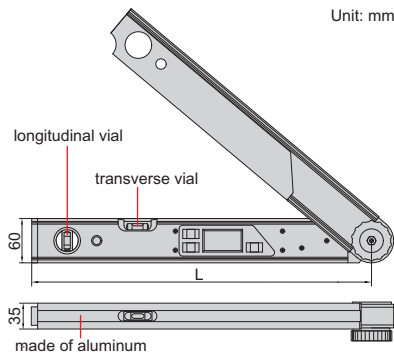
Code	Diameter	Steel balls per set
4168-S25	1, 2, 3, 4, 5, 6, 7, 8, 9, 10, 11, 12, 13, 14, 15, 16, 17, 18, 19, 20, 21, 22, 23, 24, 25mm	25 pairs

**AUTOMATIC
BACKLIGHT**

**ABSOLUTE
LEVEL**

**IP54
WATERPROOF**

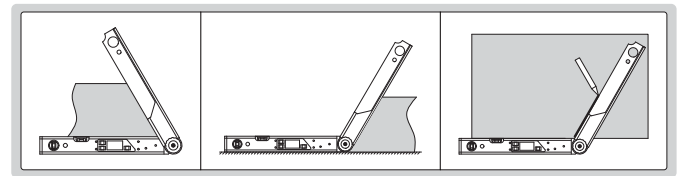
WATERPROOF DIGITAL PROTRACTOR (HEAVY DUTY)



2174-225

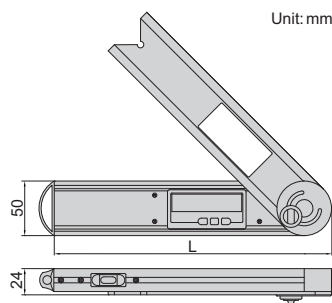
- Suitable for setting horizontal and vertical mitre angles of cutting machines
- Buttons: ON/OFF, HOLD/SUP, SPR/CNR/MTR/BVL
- IP54 dust/waterproof
- With transverse and longitudinal vials
- 2xAAA batteries
- Absolute level, zero setting is not needed when batteries are replaced
- Backlight turns off in one minute after reading is stable, automatic power off in 5 minutes

Code	Size (L)	Range	Resolution	Accuracy
2174-225	460mm	0-225°	0.05°	±0.10°



10

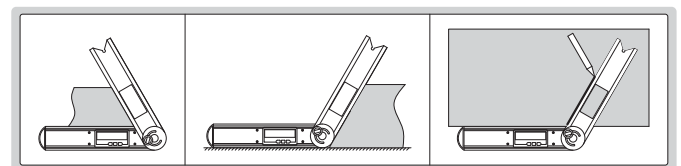
DIGITAL PROTRACTOR



2171-250

- Buttons: on/off, hold (keep the reading), zero, ABS (absolute and incremental measurement)
- Fix the locking screw at 4 positions for different measuring ranges: 0°~225°, -225°~0°, -45°~180°, -180°~45°
- Remove the locking screw for 360° range
- With level vial
- Battery CR2032, automatic power off

Code	Size (L)	Range	Resolution	Accuracy
2171-250	250mm	0 - 360°	0.05°	±0.15°

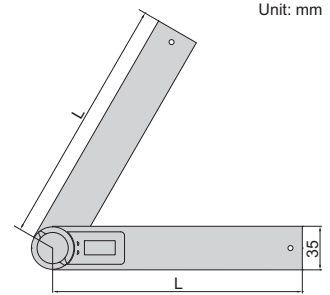


DIGITAL PROTRACTORS

- Buttons: on/off, zero
- With clamping screw to lock the blades
- Graduation of blade: 1mm and 1/32"
- Made of stainless steel
- CR2032 battery
- Automatic power off

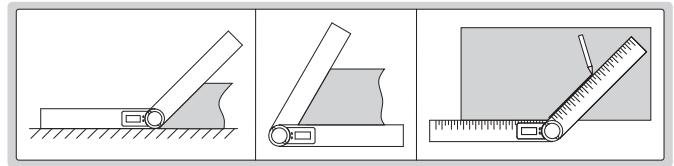


2176-200



Unit: mm

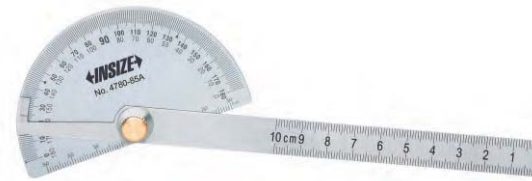
Code	Size (L)	Range	Resolution	Accuracy
2176-200	200mm	0-360°	0.1°	±0.3°
2176-300	300mm	0-360°	0.1°	±0.3°



10

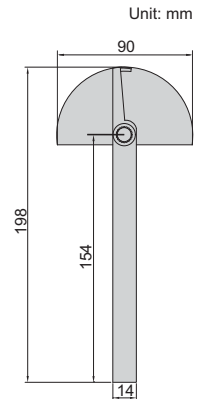
PROTRACTOR (ECONOMIC TYPE)

- Graduation: 1°
- Made of stainless steel
- With clamping screw



4780-85A

Code	Size	Range	Accuracy
4780-85A	90x154mm	0-180°	±0.5°



Unit: mm

DIGITAL PROTRACTORS

ATTENTION:
NO DATA OUTPUT

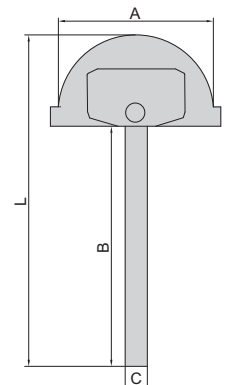
- Range: 0-180°
- Buttons: on/off, zero, hold/turn
- Made of stainless steel
- With clamping screw



4779-120

Code	Size (AxB)	Resolution	Accuracy	L	C
4779-120	120x150mm	0.05°	±0.3°	221mm	22mm
4779-150	150x200mm	0.05°	±0.3°	286mm	22mm
4779-200	200x300mm	0.05°	±0.3°	409mm	22mm

the reading can turn over

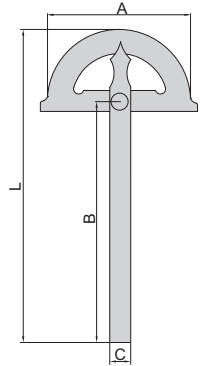


PROTRACTORS

- Graduation: 1°
- Made of stainless steel
(4799-1300 is made of carbon steel)
- Satin chrome plated scale
- With clamping screw



4799-180



Code	Size (AxB)	Range	Accuracy	L	C
4799-180	80x120mm	0-180°	±0.3°	168mm	11mm
4799-1120	120x150mm	0-180°	±0.3°	220mm	14mm
4799-1150	150x200mm	0-180°	±0.3°	285mm	16mm
4799-1200	200x300mm	0-180°	±0.3°	413mm	20mm
4799-1300	300x500mm	0-180°	±0.3°	675mm	30mm

ATTENTION:
NO DATA OUTPUT

DIGITAL PROTRACTORS

10

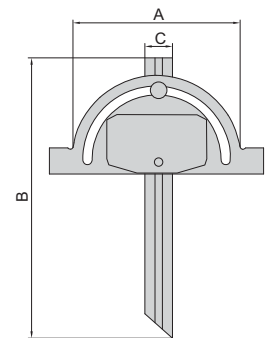
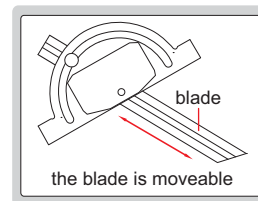
the reading can turn over



4778-100

- Range: 0-180°
- Buttons: on/off, zero, hold/turn
- Made of stainless steel
- With clamping screw
- The blade is moveable

Code	Size (AxB)	Resolution	Accuracy	C
4778-100	126x150mm	0.05°	±0.3°	22mm
4778-150	150x300mm	0.05°	±0.3°	22mm
4778-200	200x400mm	0.05°	±0.3°	24mm



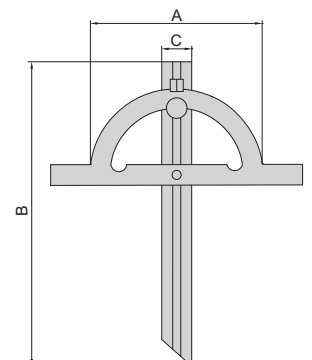
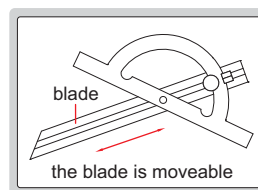
PROTRACTORS

- Graduation: 1°
- Made of carbon steel
- Satin chrome plated
- With clamping screw
- The blade is moveable



4797-100

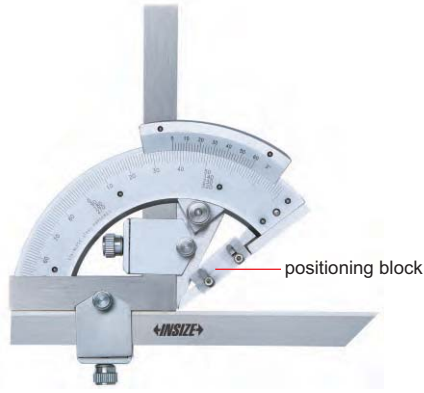
Code	Size (AxB)	Range	Accuracy	C
4797-100	100x150mm	10-170°	±0.3°	18mm
4797-150	150x300mm	10-170°	±0.3°	22mm
4797-200	200x400mm	10-170°	±0.3°	24mm
4797-250	250x500mm	10-170°	±0.3°	28mm
4797-300	300x600mm	10-170°	±0.3°	32mm



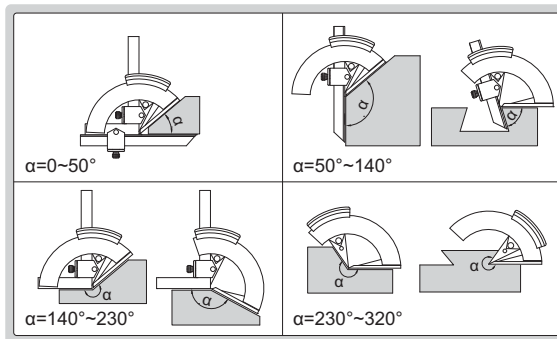
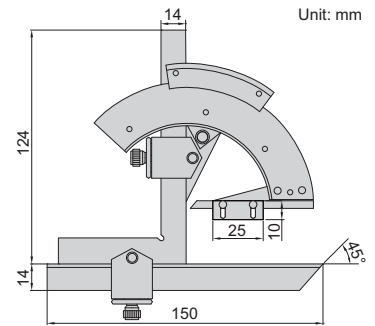
PROTRACTORS



2374-320



2374-320D



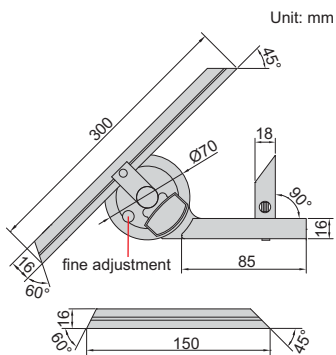
- Made of stainless steel
- Satin chrome plated scale



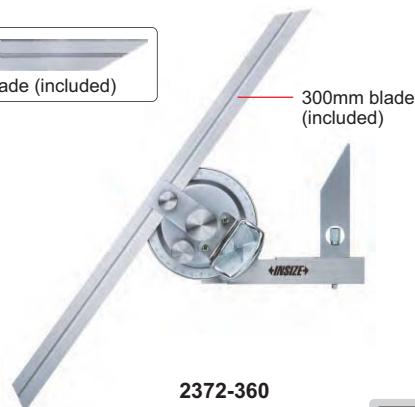
The positioning block can be moved down for positioning, and moved up when not in use

Code	Range	Graduation	Accuracy	Remark
2374-320	0-320°	2'	±2'	without positioning block
2374-320D	0-320°	2'	±2'	with positioning block

UNIVERSAL PROTRACTOR



150mm blade (included)

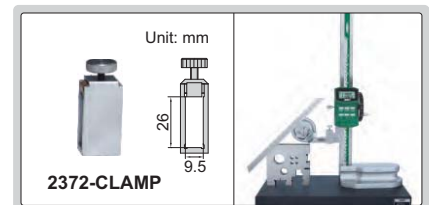


2372-360

- Parallax-free reading
- Made of stainless steel
- Optional accessory: clamp (code 2372-CLAMP), suitable for height gages 1156, 1351 and 1250

Code	Range	Graduation	Accuracy
2372-360	0-360°	5'	±5'

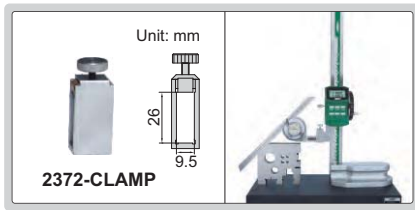
clamp for height gages (optional)



2372-CLAMP

DIAL PROTRACTOR

clamp for height gages (optional)



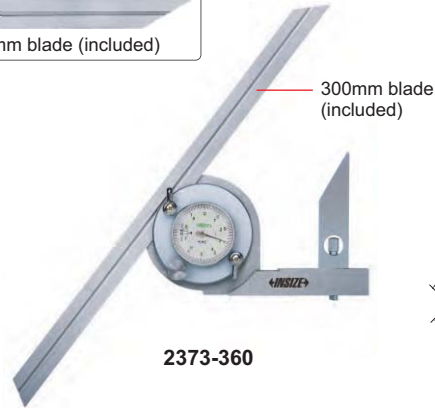
2372-CLAMP

- Made of stainless steel
- Optional accessory: clamp (code **2372-CLAMP**), suitable for height gages **1156**, **1351** and **1250**

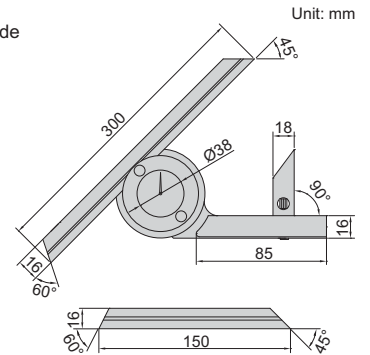
Code	Range	Graduation	Accuracy
2373-360	0-360°	5'	±5'



150mm blade (included)

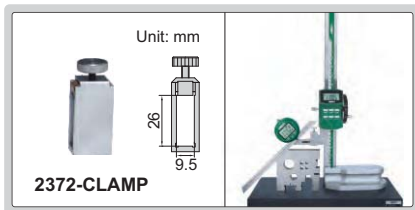


2373-360



DIGITAL PROTRACTOR

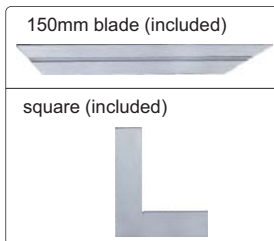
clamp for height gages (optional)



2372-CLAMP

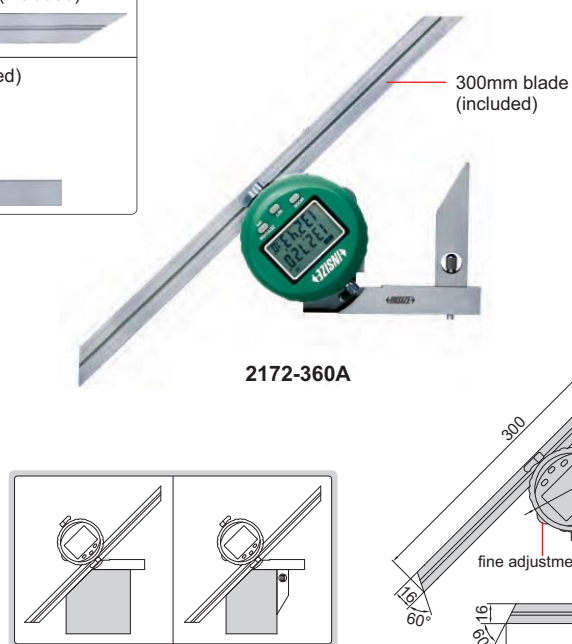
- Display in degree (for example 32.655°) and degree/minute/second (for example 32°39'30")
- SET button: preset the reading, change measuring direction
- MODE button: choose 0~90°, 0~180° or 0~360° display
- ZERO/ON/OFF button: zero and power on/off
- Battery CR2032, automatic power off
- Data output
- Supplied with square to set 90°
- Made of stainless steel
- Optional accessory: data output cable (code **7315-50**, **7302-SPC3B**), clamp (code **2372-CLAMP**), suitable for height gages **1156**, **1351** and **1250**

Code	Range	Resolution	Accuracy
2172-360A	0-360°	10"/0.005°	±5'



150mm blade (included)

square (included)

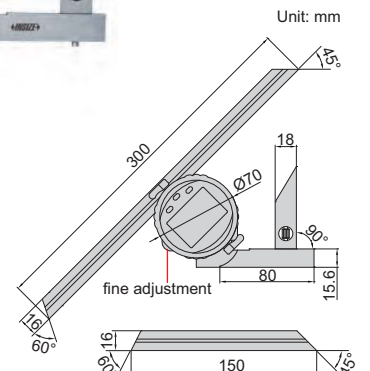


2172-360A

DATA
OUTPUT



VIDEO



CYLINDER SQUARES

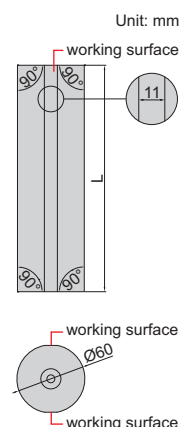
- Made of special alloy steel, hardness HRC58~60
- The handle can be removed

Code	Length (L)	Squareness
4710-200*	200mm	1µm
4710-300*	300mm	2µm

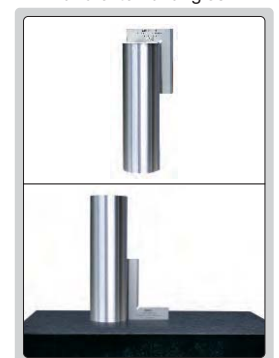
* Supplied with manufacturer inspection certificate



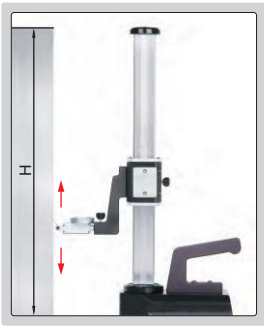
4710-200



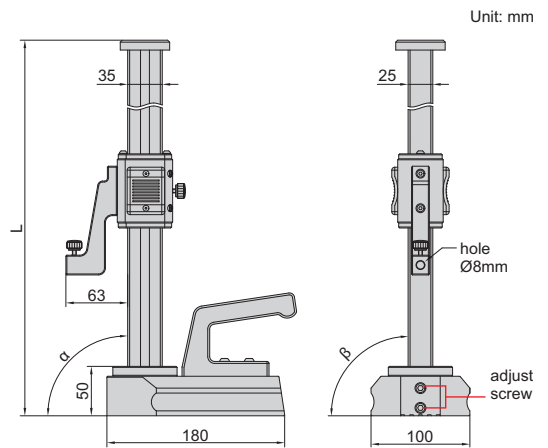
inspect 90° internal
and external angles



PERPENDICULARITY TESTERS



dial test indicator is optional



4770-300

- Optional accessory:
dial test indicators (graduation: 1µm or 2µm)

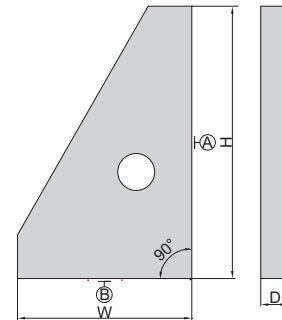
Code	Range (H)	Perpendicularity (α)	Side perpendicularity (β)	L
4770-300	0-300mm	3µm	10µm	460mm
4770-600	0-600mm	5µm	20µm	760mm

GRANITE SQUARES

CUSTOM-MADE
SUPPLY SPECIAL SIZES ACCORDING
TO CUSTOMER'S REQUEST



4141-250



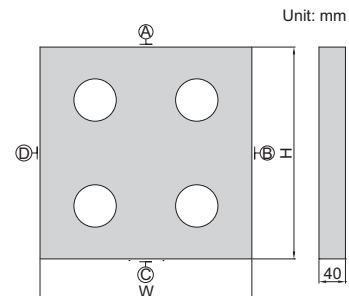
Code	Size (HxW)	Flatness of A	Flatness of B	Squareness of A to B	D
4141-250	250x160mm	1µm	1µm	2µm	25mm
4141-400	400x250mm	1.5µm	1µm	3µm	40mm
4141-630	630x400mm	2µm	1.5µm	4µm	63mm

GRANITE SQUARE

CUSTOM-MADE
SUPPLY SPECIAL SIZES ACCORDING
TO CUSTOMER'S REQUEST



4144-315



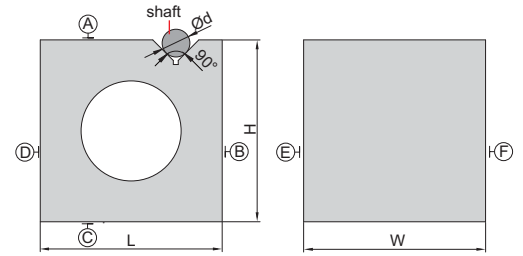
Code	Size (HxW)	Flatness of A, B, C and D	Squareness and parallelism between A, B, C and D
4144-315	315x315mm	1.1µm	2.6µm

GRANITE SQUARE WITH V GROOVE

- Parallelism and squareness of A, B, C, D, E and F: $6\mu\text{m}$
- Parallelism and squareness of V groove to A, B, C, D, E and F: $6\mu\text{m}$



4142-200



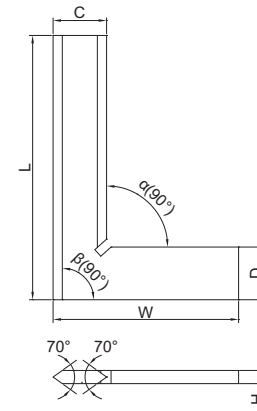
Code	Size (LxWxH)	Range of shaft (Ød)
4142-200	200x200x200mm	9~70mm

90° BEVELED EDGE SQUARES

- Satin chrome plating
- Beveled edges for inside and outside measurements
- Made of hardened stainless steel



4790-0100



Code	Size (LxW)	Squareness		C	D	H
		Inside (α)	Outside (β)			
4790-050	50x40mm	$2.4\mu\text{m}$	$2.5\mu\text{m}$	13	13	4
4790-075	75x50mm	$2.6\mu\text{m}$	$2.8\mu\text{m}$	15	15	4
4790-0100	100x70mm	$2.8\mu\text{m}$	$3.0\mu\text{m}$	20	20	5
4790-0150	150x100mm	$3.2\mu\text{m}$	$3.5\mu\text{m}$	30	30	6
4790-0200	200x130mm	$3.7\mu\text{m}$	$4.0\mu\text{m}$	34	34	7
4790-0250	250x165mm	$4.2\mu\text{m}$	$4.5\mu\text{m}$	35	35	7
4790-0300	300x200mm	$4.6\mu\text{m}$	$5.0\mu\text{m}$	40	40	8

Code	Size (LxW)	Squareness		C	D	H
		Inside (α)	Outside (β)			
4790-500	50x40mm	$6\mu\text{m}$	$6\mu\text{m}$	13	13	4
4790-750	75x50mm	$6\mu\text{m}$	$7\mu\text{m}$	15	15	4
4790-1000	100x70mm	$7\mu\text{m}$	$7\mu\text{m}$	20	20	5
4790-1500	150x100mm	$7\mu\text{m}$	$8\mu\text{m}$	30	30	6
4790-2000	200x130mm	$8\mu\text{m}$	$9\mu\text{m}$	34	34	7
4790-2500	250x165mm	$9\mu\text{m}$	$10\mu\text{m}$	35	35	7
4790-3000	300x200mm	$10\mu\text{m}$	$11\mu\text{m}$	40	40	8

90° TOOL MAKER SQUARES

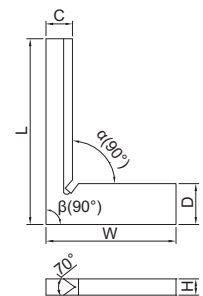
- DIN875 grade 00
- Beveled edge for inside measurement
- Made of hardened stainless steel

(mm)

Code	Size (LxW)	Squareness		C	D	H
		Inside (α)	Outside (β)			
4794-025	25x20mm	$2.2\mu\text{m}$	$2.3\mu\text{m}$	4	6.5	3.5
4794-040	40x28mm	$2.3\mu\text{m}$	$2.4\mu\text{m}$	5.5	8.5	3.5



4794-040



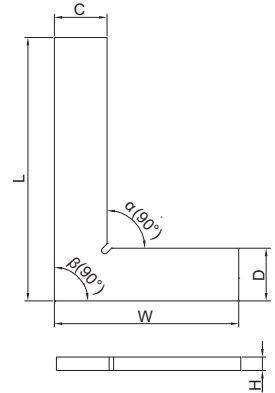
90° FLAT EDGE SQUARES

DIN875 grade 0 (mm)

Code	Size (LxW)	Squareness		C	D	H
		Inside (α)	Outside (β)			
4791-50	50x40mm	6 μ m	6 μ m	15	15	4
4791-75	75x50mm	6 μ m	7 μ m	15	15	4
4791-100	100x70mm	7 μ m	7 μ m	20	20	5
4791-150	150x100mm	7 μ m	8 μ m	30	30	6
4791-200	200x130mm	8 μ m	9 μ m	30	30	7
4791-250	250x165mm	9 μ m	10 μ m	35	35	7
4791-300	300x200mm	10 μ m	11 μ m	40	40	8

DIN875 grade 1 (mm)

Code	Size (LxW)	Squareness		C	D	H
		Inside (α)	Outside (β)			
4791-501	50x40mm	12 μ m	13 μ m	15	15	4
4791-751	75x50mm	13 μ m	14 μ m	15	15	4
4791-1001	100x70mm	14 μ m	15 μ m	20	20	5
4791-1501	150x100mm	16 μ m	18 μ m	30	30	6
4791-2001	200x130mm	19 μ m	20 μ m	30	30	6



4791-100

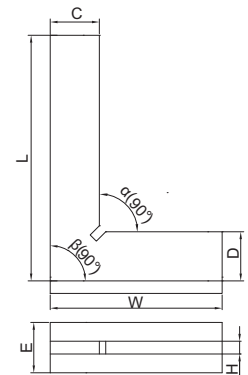
- Made of hardened stainless steel

90° FLAT EDGE SQUARES WITH WIDE BASE

- DIN875 grade 0
- Made of hardened stainless steel

(mm)

Code	Size (LxW)	Squareness		C	D	H	E
		Inside (α)	Outside (β)				
4793-50	50x40mm	6 μ m	6 μ m	13	13	4	13
4793-75	75x50mm	6 μ m	7 μ m	15	15	4	15
4793-100	100x70mm	7 μ m	7 μ m	20	20	5	20
4793-150	150x100mm	7 μ m	8 μ m	30	30	6	30
4793-200	200x130mm	8 μ m	9 μ m	30	30	7	30
4793-250	250x165mm	9 μ m	10 μ m	35	35	7	35
4793-300	300x200mm	10 μ m	11 μ m	40	40	8	40



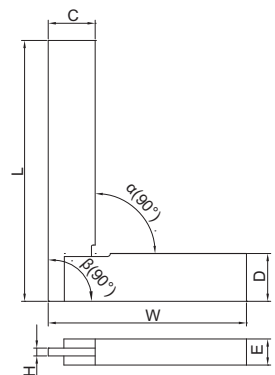
4793-100

90° FLAT EDGE SQUARES WITH WIDE BASE

- DIN875 grade 0
- Made of hardened stainless steel

(mm)

Code	Size (LxW)	Squareness		C	D	H	E
		Inside (α)	Outside (β)				
4792-50	50x40mm	6 μ m	6 μ m	12	12	3	10
4792-75	75x50mm	6 μ m	7 μ m	14	14	3	10
4792-100	100x70mm	7 μ m	7 μ m	18	18	3	10
4792-150	150x100mm	8 μ m	8 μ m	22	22	4	12
4792-200	200x130mm	9 μ m	9 μ m	25	25	4	12

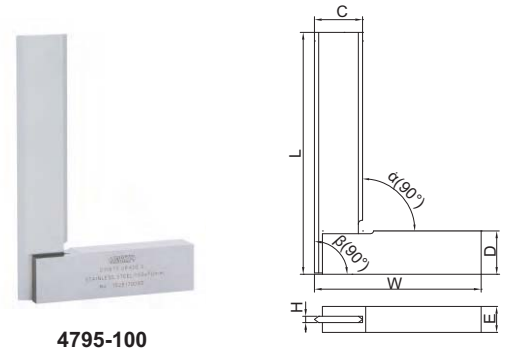


4792-100

90° BEVELED EDGE SQUARES WITH WIDE BASE

- DIN875 grade 0
- Beveled edges for inside and outside measurements
- Made of hardened stainless steel

Code	Size (LxW)	Squareness		C	D	H	E
		Inside (α)	Outside (β)				
4795-50	50x40mm	6 μ m	6 μ m	12	12	3	10
4795-75	75x50mm	6 μ m	7 μ m	14	14	3	10
4795-100	100x70mm	7 μ m	7 μ m	18	18	3	10
4795-150	150x100mm	8 μ m	8 μ m	22	22	4	12
4795-200	200x130mm	9 μ m	9 μ m	25	25	4	12



4795-100

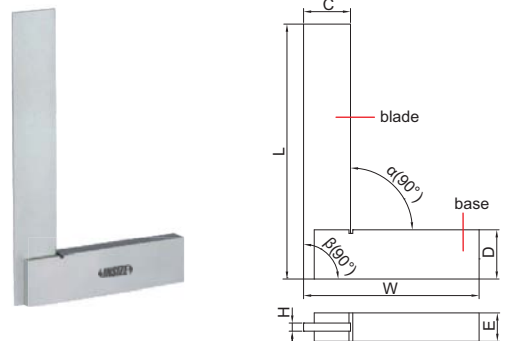
ATTENTION: NO ANTI-RUST TREATMENT, NOT HARDEND

ATTENTION: LOW ACCURACY

MACHINIST SQUARES WITH WIDE BASE (ECONOMIC TYPE)

- DIN875 grade 2
- Made of carbon steel, no anti-rust treatment, not hardend

Code	Size (LxW)	Squareness		C	D	H	E
		Inside (α)	Outside (β)				
4707-50	50x40mm	24 μ m	25 μ m	16	12	3	9
4707-75	75x50mm	26 μ m	28 μ m	16	16	3	9
4707-100	100x70mm	28 μ m	30 μ m	19	19	3	12
4707-150	150x100mm	33 μ m	35 μ m	25	25	3	16
4707-200	200x130mm	37 μ m	40 μ m	30	32	4	16
4707-250	250x165mm	42 μ m	45 μ m	30	32	4	19
4707-300	300x200mm	47 μ m	50 μ m	32	32	4	19
4707-400	400x250mm	56 μ m	60 μ m	38	38	5	22
4707-500	500x300mm	65 μ m	70 μ m	45	50	6	25
4707-600	600x350mm	75 μ m	80 μ m	50	50	6	30
4707-750	750x400mm	90 μ m	95 μ m	55	55	6	50
4707-900	900x500mm	103 μ m	110 μ m	65	75	9	50
4707-1000	1000x550mm	113 μ m	120 μ m	65	75	9	50



4707-100

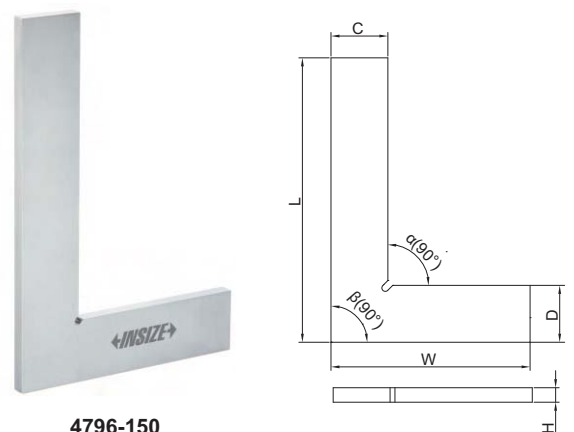
ATTENTION: NO ANTI-RUST TREATMENT, NOT HARDEND

ATTENTION: LOW ACCURACY

MACHINIST SQUARES (ECONOMIC TYPE)

- DIN875 grade 2
- Made of carbon steel, no anti-rust treatment, not hardend

Code	Size (LxW)	Squareness		C	D	H
		Inside (α)	Outside (β)			
4796-50	50x30mm	24 μ m	25 μ m	12	12	3
4796-75	75x50mm	26 μ m	28 μ m	16	16	3
4796-100	100x70mm	28 μ m	30 μ m	19	19	5
4796-125	125x80mm	30 μ m	33 μ m	22	22	5
4796-150	150x100mm	33 μ m	35 μ m	25	25	6
4796-200	200x130mm	38 μ m	40 μ m	25	25	6
4796-250	250x165mm	43 μ m	45 μ m	25	25	6
4796-300	300x200mm	47 μ m	50 μ m	30	30	6
4796-350	350x200mm	51 μ m	55 μ m	38	38	6
4796-400	400x200mm	56 μ m	60 μ m	38	38	9
4796-450	450x250mm	58 μ m	65 μ m	38	38	9
4796-500	500x300mm	69 μ m	70 μ m	38	38	9



4796-150

MACHINIST SQUARES WITH WIDE BASE AND SCALE (ECONOMIC TYPE)

ATTENTION: NO ANTI-RUST TREATMENT, NOT HARDEND

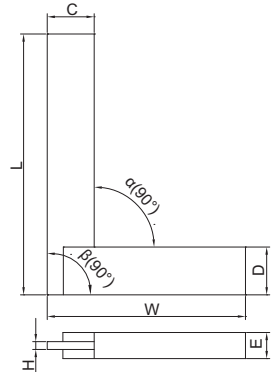
ATTENTION: LOW ACCURACY

- DIN875 grade 2
- Made of carbon steel, no anti-rust treatment, not hardend

Code	Size (LxW)	Squareness		C	D	H	E	(mm)
		Inside (α)	Outside (β)					
4711-50	50x30mm	24 μ m	25 μ m	16	12	2.5	9	
4711-75	75x50mm	26 μ m	28 μ m	16	16	2.5	9	
4711-100	100x70mm	28 μ m	30 μ m	19	19	3	12	
4711-150	150x100mm	33 μ m	35 μ m	25	25	3	16	
4711-200	200x130mm	37 μ m	40 μ m	30	32	3	16	
4711-250	250x165mm	42 μ m	45 μ m	30	32	3	19	
4711-300	300x200mm	47 μ m	50 μ m	32	32	3	19	
4711-400	400x200mm	56 μ m	60 μ m	38	38	4.5	22	
4711-500	500x300mm	65 μ m	70 μ m	44	50	6	25	
4711-600	600x350mm	75 μ m	80 μ m	50	50	6	30	
4711-750	750x400mm	90 μ m	95 μ m	55	55	6	50	



4711-100



10

MAGNALIUM 90° FLAT EDGE SQUARES WITH WIDE BASE

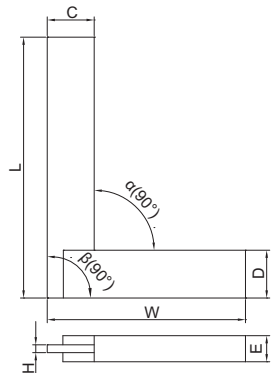
ATTENTION: LOW ACCURACY

- Made of magnalium, light weight, non-deform, no rusty

Code	Size (LxW)	Squareness		C	D	H	E	Weight	(mm)
		Inside (α)	Outside (β)						
4705-630	630x400mm	107 μ m	113 μ m	40	60	18	40	5kg	
4705-800	800x500mm	123 μ m	130 μ m	50	70	25	50	7kg	
4705-1000	1000x630mm	143 μ m	150 μ m	50	70	25	50	9kg	
4705-1250	1250x800mm	168 μ m	175 μ m	50	70	25	50	11kg	
4705-1600	1600x1000mm	203 μ m	210 μ m	50	70	25	50	13kg	
4705-2000	2000x1250mm	243 μ m	250 μ m	50	70	25	50	15kg	
4705-2600	2600x1500mm	303 μ m	310 μ m	50	70	25	50	20kg	



4705-630



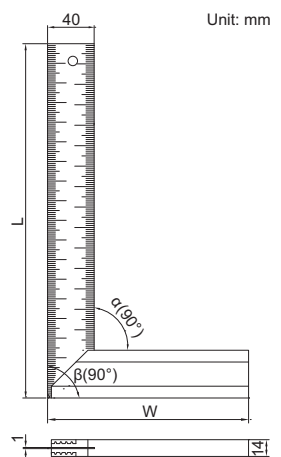
TRY SQUARE

- Graduation: 1mm
- Stainless steel blade, aluminum base

Code	Size (LxW)	Squareness	
		Inside (α)	Outside (β)
2275-300	300x170mm	0.5mm	0.5mm



2275-300

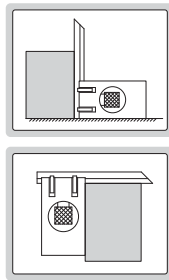


Unit: mm

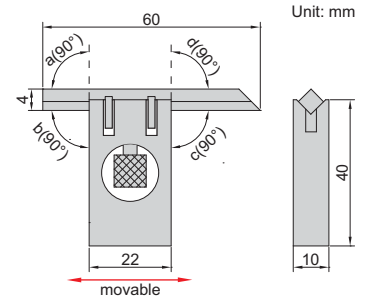
ADJUSTABLE SQUARE

- The straight edge can move and can be locked by the clamping screw
- Made of hardened stainless steel

Code	Squareness (a, b, c, d)
4701-1	7 μ m



4701-1



Unit: mm

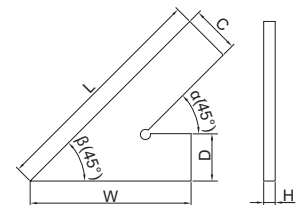
45° SQUARES

- Made of hardened stainless steel

Code	Size (LxW)	Accuracy		(mm)		
		Inside (α)	Outside (β)	C	D	H
4745-1120	120x80mm	29 μ m	32 μ m	20	20	5
4745-1150	150x100mm	32 μ m	35 μ m	20	20	5
4745-1200	200x130mm	36 μ m	40 μ m	25	25	5



4745-1120



10

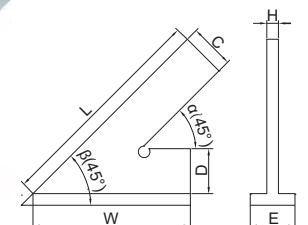
45° SQUARES WITH WIDE BASE

- Made of hardened stainless steel

Code	Size (LxW)	Accuracy		(mm)			
		Inside (α)	Outside (β)	C	D	H	E
4747-120	120x80mm	29 μ m	33 μ m	20	20	5	20
4747-150	150x100mm	32 μ m	36 μ m	20	20	5	20
4747-200	200x130mm	36 μ m	41 μ m	25	25	5	25



4747-120



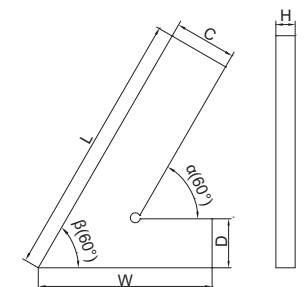
60° SQUARES

- Made of hardened stainless steel

Code	Size (LxW)	Accuracy		(mm)		
		Inside (α)	Outside (β)	C	D	H
4760-1120	120x80mm	30 μ m	32 μ m	20	20	5
4760-1150	150x100mm	32 μ m	35 μ m	20	20	5
4760-1200	200x130mm	37 μ m	40 μ m	25	25	5

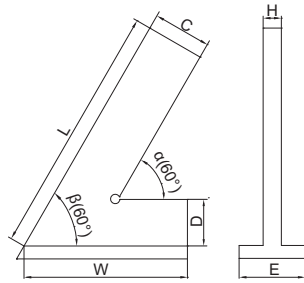


4760-1120



60° SQUARES WITH WIDE BASE

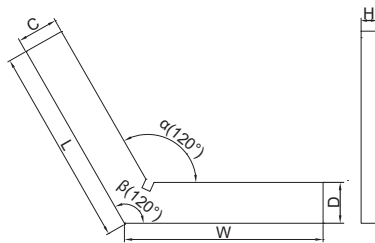
- Made of hardened stainless steel



4762-120

Code	Size (LxW)	Accuracy		C	D	H	E
		Inside (α)	Outside (β)				
4762-120	120x80mm	30 μ m	33 μ m	20	20	5	20
4762-150	150x100mm	33 μ m	36 μ m	20	20	5	20
4762-200	200x130mm	37 μ m	41 μ m	25	25	5	25

10 120° SQUARES

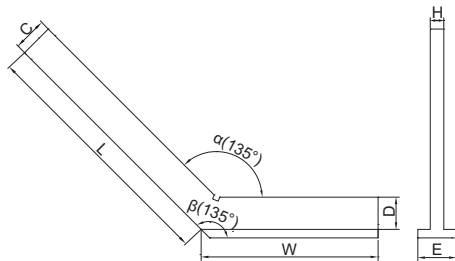


4706-1100

Code	Size (LxW)	Accuracy		C	D	H
		Inside (α)	Outside (β)			
4706-150	50x50mm	24 μ m	25 μ m	15	15	5
4706-175	75x75mm	26 μ m	28 μ m	20	20	5
4706-1100	100x100mm	29 μ m	30 μ m	20	20	5
4706-1150	150x150mm	34 μ m	35 μ m	25	25	5
4706-1200	200x200mm	38 μ m	40 μ m	30	30	7

- Made of hardened stainless steel

135° SQUARES WITH WIDE BASE



4754-3120

Code	Size (LxW)	Accuracy		C	D	H	E
		Inside (α)	Outside (β)				
4754-3120	120x80mm	31 μ m	33 μ m	20	20	5	20
4754-3150	150x100mm	34 μ m	36 μ m	20	20	5	20
4754-3200	200x130mm	39 μ m	41 μ m	30	30	7	30

- Made of hardened stainless steel

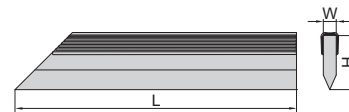
STRAIGHT EDGES

- DIN874
- Beveled edge
- Made of hardened stainless steel
- Satin chrome plating

Code	Size (L)	Straightness	W	H
4700-50	50mm	2.2µm	5mm	20mm
4700-75	75mm	2.3µm	5mm	25mm
4700-100	100mm	2.4µm	5mm	25mm
4700-125	125mm	2.5µm	6mm	30mm
4700-150	150mm	2.6µm	6mm	30mm
4700-200	200mm	2.8µm	6mm	30mm
4700-250	250mm	3.0µm	8mm	40mm
4700-300	300mm	3.2µm	8mm	40mm
4700-400	400mm	3.6µm	10mm	50mm
4700-500	500mm	4.0µm	10mm	50mm



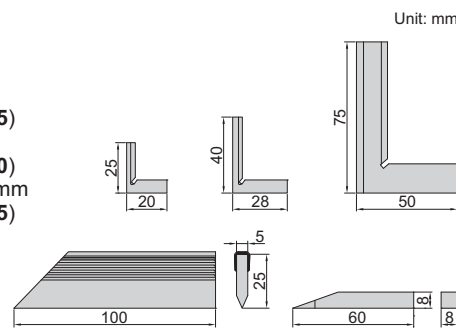
4700-100



10

SQUARE SET

- Includes:
 - 90° tool maker square 25x20mm DIN875 grade 00 (code **4794-025**)
 - 90° tool maker square 40x28mm DIN875 grade 00 (code **4794-040**)
 - 90° beveled edge square 75x50mm DIN875 grade 00 (code **4790-075**)
 - straight edge 100mm DIN874 (code **4700-100**)
 - scriber
- Made of hardened stainless steel



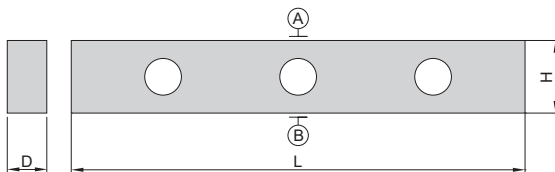
Unit: mm



4702-1

Code
4702-1

GRANITE STRAIGHT EDGES

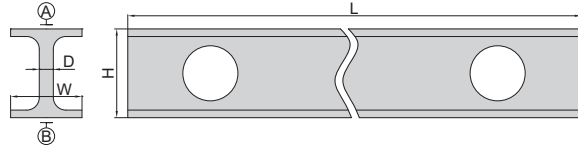


4147-500A

Code	Length (L)	Flatness of A and B	Parallelism between A and B	D	H
4147-500A	500mm	2.1µm	3.2µm	50mm	80mm
4147-1000A	1000mm	3.0µm	4.5µm	60mm	120mm

MAGNALIUM STRAIGHT EDGES

- Made of magnalium, light weight, non-deform, no rusty



4180-1500

Code	Length (L)	Flatness of A and B	Parallelism between A and B	H	W	D	Weight
4180-500	500mm	3 μ m	4 μ m	60mm	30mm	5mm	0.8kg
4180-1000	1000mm	5 μ m	8 μ m	60mm	30mm	5mm	1.5kg
4180-1500	1500mm	15 μ m	22 μ m	100mm	40mm	7mm	2.3kg
4180-2000	2000mm	18 μ m	27 μ m	100mm	40mm	7mm	6kg
4180-2500	2500mm	22 μ m	33 μ m	100mm	40mm	7mm	7.5kg
4180-3000	3000mm	48 μ m	72 μ m	150mm	80mm	8mm	21kg

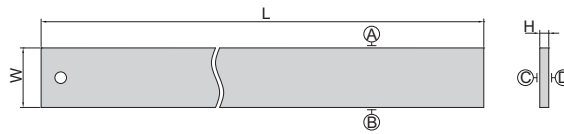
10

PRECISION STRAIGHT EDGES

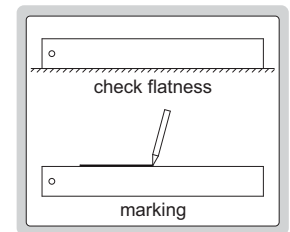


7117-300

- Check flatness and for marking
- Made of tool steel



Code	Range (L)	Flatness of A and B	Flatness of C and D	W	H
7117-300	305mm	0.005mm	0.05mm	41mm	6.3mm
7117-600	610mm	0.006mm	0.06mm	51mm	7.9mm
7117-900	914mm	0.007mm	0.06mm	64mm	9.5mm

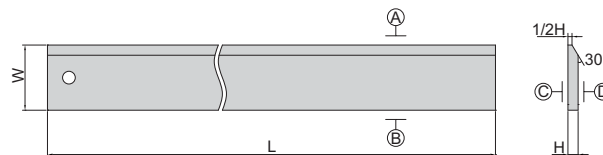


PRECISION STRAIGHT EDGES WITH BEVELED EDGE

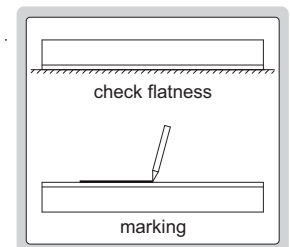


7118-300

- Check flatness and for marking
- Made of tool steel



Code	Range (L)	Flatness of A and B	Flatness of C and D	W	H
7118-300	305mm	0.005mm	0.05mm	41mm	6.3mm
7118-600	610mm	0.006mm	0.06mm	51mm	7.9mm
7118-900	914mm	0.007mm	0.06mm	64mm	9.5mm

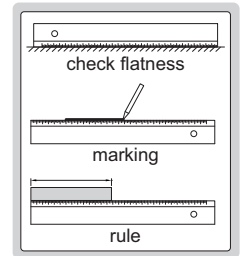
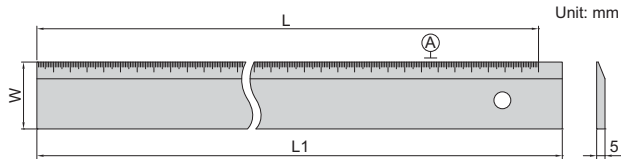


STRAIGHT EDGES



7111-300A

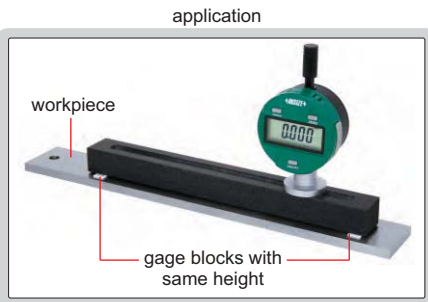
- Check flatness and straightness, as well as for marking
- Graduation on the beveled edge
- Made of hardened tool steel
- Chrome plated



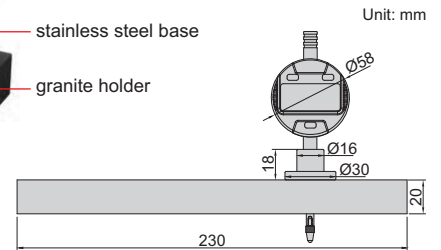
Code	Range (L)	Straightness of A	L1	W
7111-300A	300mm	0.02mm	310mm	40mm
7111-500A	500mm	0.03mm	510mm	40mm
7111-1000A	1000mm	0.04mm	1010mm	50mm

GRANITE HODLER CAN BE CUSTOMIZED ACCORDING TO WORKPIECES

STRAIGHTNESS/FLATNESS GAGE



2144-200



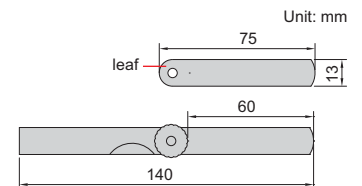
Code	Range	Digital indicator resolution	Straightness measurement accuracy	Parallelism of top and bottom surfaces of granite holder	Flatness of top and bottom surfaces of granite holder
2144-200	200mm	0.001mm/0.00005"	3µm	2µm	1.5µm

FEELER GAGE

- Made of hardened alloy steel
- Meet DIN2275
- Accuracy: $\pm(3+T/80)$ µm, 'T' is the thickness of leaves in µm



4601-25



Code	Range	Thickness of leaves included (mm)	Quantity of leaves
4601-25	0.04-1.00mm	0.04, 0.05, 0.06, 0.07, 0.08, 0.09, 0.10, 0.15, 0.20, 0.25, 0.30, 0.35, 0.40, 0.45, 0.50, 0.55, 0.60, 0.65, 0.70, 0.75, 0.80, 0.85, 0.90, 0.95, 1.00	25

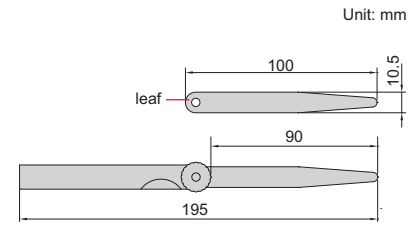
10
11

FEELER GAGES

- Made of hardened alloy steel
- Meet DIN2275
- Accuracy: $\pm(3+T/80)$ μm ,
'T' is the thickness of leaves in μm



4602-20



Code	Range	Thickness of leaves included (mm)	Quantity of leaves
4602-13A	0.03-0.50mm	0.03, 0.04, 0.05, 0.06, 0.07, 0.08, 0.09, 0.10, 0.15, 0.20, 0.30, 0.40, 0.50	13
4602-13	0.05-1.00mm	0.05, 0.10, 0.15, 0.20, 0.25, 0.30, 0.40, 0.50, 0.60, 0.70, 0.80, 0.90, 1.00	13
4602-17	0.02-1.00mm	0.02, 0.03, 0.04, 0.05, 0.06, 0.07, 0.08, 0.09, 0.10, 0.15, 0.20, 0.25, 0.30, 0.40, 0.50, 0.75, 1.00	17
4602-20	0.05-1.00mm	0.05, 0.10, 0.15, 0.20, 0.25, 0.30, 0.35, 0.40, 0.45, 0.50, 0.55, 0.60, 0.65, 0.70, 0.75, 0.80, 0.85, 0.90, 0.95, 1.00	20
4602-28	0.05-1.00mm	0.05, 0.06, 0.07, 0.08, 0.09, 0.10, 0.11, 0.12, 0.13, 0.14, 0.15, 0.20, 0.25, 0.30, 0.35, 0.40, 0.45, 0.50, 0.55, 0.60, 0.65, 0.70, 0.75, 0.80, 0.85, 0.90, 0.95, 1.00	28
4602-32	0.03-1.00mm	0.03, 0.04, 0.05, 0.06, 0.07, 0.08, 0.09, 0.10, 0.13, 0.15, 0.18, 0.20, 0.23, 0.25, 0.28, 0.30, 0.33, 0.35, 0.38, 0.40, 0.45, 0.50, 0.55, 0.60, 0.63, 0.65, 0.70, 0.75, 0.80, 0.85, 0.90, 1.00	32

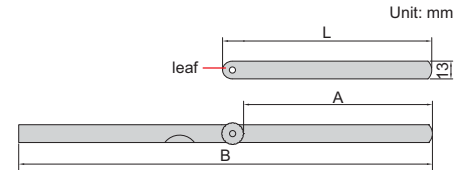
11

LONG FEELER GAGES

- Made of hardened alloy steel
- Meet DIN2275
- Accuracy: $\pm(3+T/80)$ μm ,
'T' is the thickness of leaves in μm



4605-20



Code	Range	Thickness of leaves included (mm)	Quantity of leaves	L	A	B
4605-13	0.05-1.00mm	0.05, 0.10, 0.15, 0.20, 0.25, 0.30, 0.40, 0.50, 0.60, 0.70, 0.80, 0.90, 1.00	13	150mm	135mm	295mm
4605-131	0.05-1.00mm		13	200mm	185mm	395mm
4605-132	0.05-1.00mm		13	300mm	285mm	590mm
4605-20	0.05-1.00mm	0.05, 0.10, 0.15, 0.20, 0.25, 0.30, 0.35, 0.40, 0.45, 0.50, 0.55, 0.60, 0.65, 0.70, 0.75, 0.80, 0.85, 0.90, 0.95, 1.00	20	150mm	135mm	295mm
4605-201	0.05-1.00mm		20	200mm	185mm	395mm
4605-202	0.05-1.00mm		20	300mm	285mm	590mm

INCH FEELER GAGE

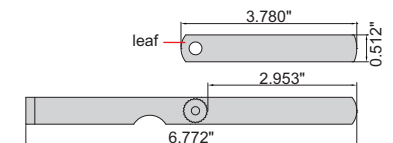


4608-31

- 0.010" is made of brass, others are made of hardened alloy steel
- Each blade is marked with inch/metric size

Code	Range	Quantity of Leaves
4608-31	0.0015"~0.035"	32

Thickness of leaves included	Accuracy
0.010" (brass)	± 0.00039 "
0.0015", 0.002"	± 0.0002 "
0.0025", 0.003", 0.004", 0.005", 0.006", 0.007"	± 0.00028 "
0.008", 0.009"	± 0.00035 "
0.010", 0.011"	± 0.00039 "
0.012", 0.013"	± 0.00047 "
0.014", 0.015"	± 0.00051 "



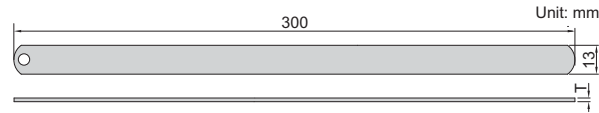
Thickness of leaves included	Accuracy
0.016", 0.017"	± 0.00055 "
0.018", 0.019"	± 0.00059 "
0.020", 0.021"	± 0.00067 "
0.022", 0.023"	± 0.00071 "
0.024", 0.025", 0.026"	± 0.00075 "
0.028"	± 0.00091 "
0.030"	± 0.00094 "
0.032", 0.035"	± 0.00102 "

FEELER GAGE STOCKS



4622-10

- Used as shims to accurately set spacing
- Made of hardened alloy steel
- Length 300mm
- Width 13mm
- 10 pcs per package



Code	Thickness (T)	Accuracy
4622-02	0.02mm	±3μm
4622-03	0.03mm	±3μm
4622-04	0.04mm	±3μm
4622-05	0.05mm	±3μm
4622-06	0.06mm	±3μm
4622-07	0.07mm	±4μm
4622-08	0.08mm	±4μm
4622-09	0.09mm	±4μm
4622-10	0.10mm	±4μm
4622-12	0.12mm	±5μm

Code	Thickness (T)	Accuracy
4622-15	0.15mm	±5μm
4622-18	0.18mm	±6μm
4622-20	0.20mm	±6μm
4622-25	0.25mm	±6μm
4622-30	0.30mm	±7μm
4622-35	0.35mm	±7μm
4622-40	0.40mm	±8μm
4622-45	0.45mm	±8μm
4622-50	0.50mm	±9μm
4622-55	0.55mm	±9μm

Code	Thickness (T)	Accuracy
4622-60	0.60mm	±9μm
4622-65	0.65mm	±9μm
4622-70	0.70mm	±12μm
4622-75	0.75mm	±12μm
4622-80	0.80mm	±13μm
4622-85	0.85mm	±13μm
4622-90	0.90mm	±14μm
4622-95	0.95mm	±14μm
4622-100	1.00mm	±16μm

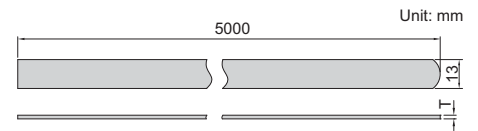
11

FEELER GAGE TAPES

- Used as shims to accurately set spacing
- Made of hardened alloy steel
- Length 5m
- Width 13mm



4621-30



Code	Thickness (T)	Accuracy
4621-02	0.02mm	±4μm
4621-03	0.03mm	±4μm
4621-04	0.04mm	±4μm
4621-05	0.05mm	±4μm
4621-06	0.06mm	±4μm
4621-07	0.07mm	±5μm
4621-08	0.08mm	±5μm
4621-09	0.09mm	±5μm
4621-10	0.10mm	±5μm
4621-12	0.12mm	±5μm
4621-15	0.15mm	±6μm
4621-18	0.18mm	±7μm
4621-20	0.20mm	±8μm
4621-25	0.25mm	±9μm

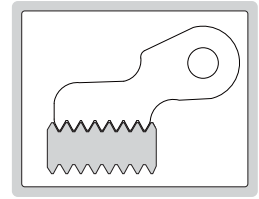
Code	Thickness (T)	Accuracy
4621-30	0.30mm	±9μm
4621-35	0.35mm	±11μm
4621-40	0.40mm	±12μm
4621-45	0.45mm	±12μm
4621-50	0.50mm	±14μm
4621-55	0.55mm	±14μm
4621-60	0.60mm	±14μm
4621-65	0.65mm	±14μm
4621-70	0.70mm	±17μm
4621-75	0.75mm	±17μm
4621-80	0.80mm	±19μm
4621-85	0.85mm	±19μm
4621-90	0.90mm	±22μm
4621-95	0.95mm	±22μm
4621-100	1.00mm	±24μm

PITCH GAGES

- Identify the pitch of screw thread
- Made of medium carbon steel



4820-122



Metric 60° screw

Code	Range	Pitch of leaves included (mm)	Quantity of leaves
4820-122	0.4-7.0mm	0.4, 0.5, 0.6, 0.7, 0.75, 0.8, 0.9, 1, 1.25, 1.5, 1.75, 2, 2.5, 3, 3.5, 4, 4.5, 5, 5.5, 6, 6.5, 7	22
4820-124	0.25-7.0mm	0.25, 0.3, 0.35, 0.4, 0.5, 0.7, 0.75, 0.8, 0.9, 1, 1.25, 1.5, 1.75, 2, 2.5, 3, 3.5, 4, 4.5, 5, 5.5, 6, 6.5, 7	24
4820-1241	0.25-6.0mm	0.25, 0.3, 0.35, 0.4, 0.45, 0.5, 0.6, 0.7, 0.75, 0.8, 0.9, 1, 1.25, 1.5, 1.75, 2, 2.5, 3, 3.5, 4, 4.5, 5, 5.5, 6	24

Unified 60° screw

Code	Range	Pitch of leaves included	Quantity of leaves
4820-230	4-42TPI	4, 4-1/2, 5, 5-1/2, 6, 7, 8, 9, 10, 11, 11-1/2, 12, 13, 14, 15, 16, 18, 20, 22, 24, 26, 27, 28, 30, 32, 34, 36, 38, 40, 42TPI	30

Whitworth 55° screw

Code	Range	Pitch of leaves included	Quantity of leaves
4820-330	4-42TPI	4, 4-1/2, 5, 5-1/2, 6, 7, 8, 9, 10, 11, 12, 13, 14, 15, 16, 18, 19, 20, 22, 24, 26, 27, 28, 30, 32, 34, 36, 38, 40, 42TPI	30
4820-328	4-62TPI	4, 4-1/2, 5, 6, 7, 8, 9, 10, 11, 12, 13, 14, 16, 18, 19, 20, 22, 24, 25, 26, 28, 30, 32, 36, 40, 48, 60, 62TPI	28

Metric 60° and Whitworth 55° screw

Code	Range	Pitch of leaves included	Quantity of leaves
4820-452	0.25-6.0mm	0.25, 0.3, 0.35, 0.4, 0.45, 0.5, 0.6, 0.7, 0.75, 0.8, 0.9, 1, 1.25, 1.5, 1.75, 2, 2.5, 3, 3.5, 4, 4.5, 5, 5.5, 6mm	52
	4-62TPI	4, 4-1/2, 5, 6, 7, 8, 9, 10, 11, 12, 13, 14, 16, 18, 19, 20, 22, 24, 25, 26, 28, 30, 32, 36, 40, 48, 60, 62TPI	
4820-450	0.4-7.0mm	0.4, 0.5, 0.6, 0.7, 0.75, 0.8, 0.9, 1, 1.25, 1.5, 1.75, 2, 2.5, 3, 3.5, 4, 4.5, 5, 5.5, 6, 6.5, 7mm	50
	4-62TPI	4, 4-1/2, 5, 6, 7, 8, 9, 10, 11, 12, 13, 14, 16, 18, 19, 20, 22, 24, 25, 26, 28, 30, 32, 36, 40, 48, 60, 62TPI	

Metric 60° and Unified 60° screw

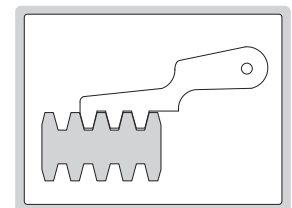
Code	Range	Pitch of leaves included	Quantity of leaves
4820-552	0.4-7.0mm	0.4, 0.5, 0.6, 0.7, 0.75, 0.8, 0.9, 1, 1.25, 1.5, 1.75, 2, 2.5, 3, 3.5, 4, 4.5, 5, 5.5, 6, 6.5, 7mm	52
	4-42TPI	4, 4-1/2, 5, 5-1/2, 6, 7, 8, 9, 10, 11, 11-1/2, 12, 13, 14, 15, 16, 18, 20, 22, 24, 26, 27, 28, 30, 32, 34, 36, 38, 40, 42TPI	

PITCH GAGES

- Check the pitch of screw thread
- Accuracy: ± 0.07 mm
- Made of medium carbon steel



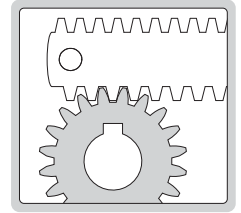
4824-12



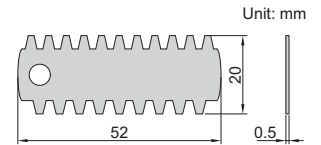
Code	Range	Thread type	Pitch of leaves included	Quantity of leaves
4824-12	2-20mm	Tr30°	2, 3, 4, 5, 6, 7, 8, 9, 10, 12, 16, 20mm	12
4824-16	1-12TPI	ACME 29°	1, 1-1/3, 1-1/2, 1-3/4, 2, 2-1/2, 3, 3-1/2, 4, 5, 6, 7, 8, 9, 10, 12TPI	16

GEAR TOOTH PITCH GAGES

- Check the module pitch of gear tooth
- Accuracy: $\pm 0.05\text{mm}$
- Made of hardened stainless steel

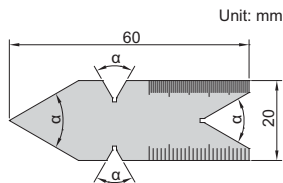


4860-245



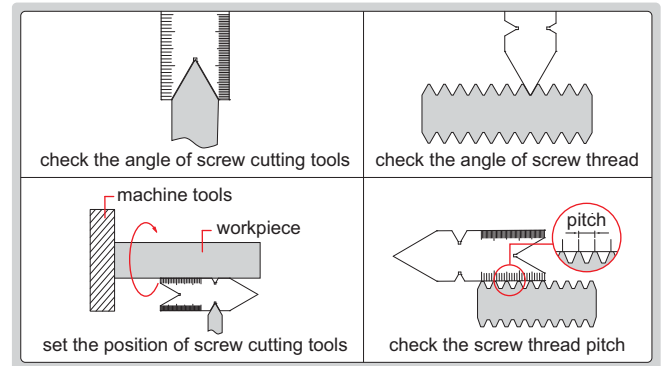
Code	Range	Pressure angle	Quantity of leaves
4860-145	0.35-4.5mm	14.5°	15
4860-245	0.35-4.5mm	20°	15
4860-112	5-12mm	14.5°	8
4860-212	5-12mm	20°	8

CENTER GAGES



4810-602

- To check and set screw cutting tools, and check the angle and pitch of screw thread
- Angle accuracy: $\pm 30\text{min}$.
- Made of stainless steel



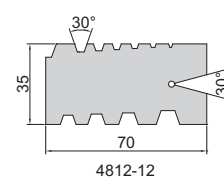
Code	Thread type	Angle (α)	Graduation
4810-601	METRIC 60°	60°	0.5mm and 1mm
4810-602	UNIFIED 60°	60°	14ths and 20ths on front side, 24ths and 32ths on back side
4810-55	WHITWORTH 55°	55°	14ths and 20ths on front side, 24ths and 32ths on back side

THREAD GAGES

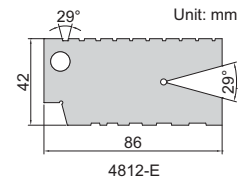


4812-E

- To check and set screw cutting tools
- Made of medium carbon steel

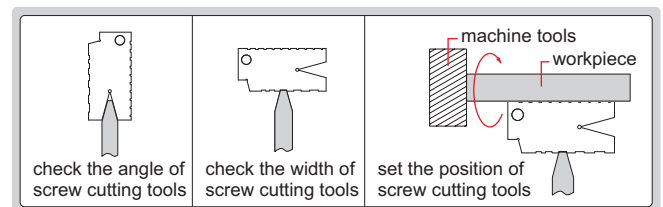


4812-12

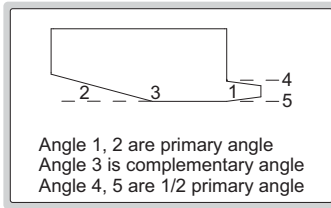


4812-E

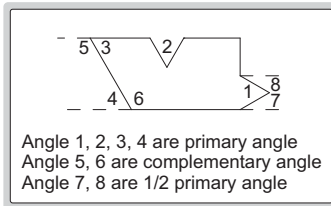
Code	Range	Thread type	Pitch
4812-12	2-12mm	Tr 30°	2, 3, 4, 5, 6, 7, 8, 9, 10, 12mm
4812-E	1-10TPI	ACME 29°	1, 1-1/3, 1-1/2, 1-3/4, 2, 2-1/2, 3, 4, 5, 6, 7, 8, 9, 10TPI



ANGLE GAGE SET



type A



type B



4807

Primary angle	1/2 primary angle	Complementary angle	Type
5°	2°30'	175°	A
10°	5°	170°	A
15°	7°30'	165°	A
20°	10°	160°	B
25°	12°30'	155°	B
30°	15°	150°	B
35°	17°30'	145°	B
40°	20°	140°	B
45°	22°30'	135°	B
50°	25°	130°	B
55°	27°30'	125°	B
60°	30°	120°	B
65°	32°30'	115°	B
70°	35°	110°	B
75°	37°30'	105°	B
80°	40°	100°	B
85°	42°30'	95°	B
90°	45°	90°	B

Code	Quantity of leaves	Accuracy
4807	18	±10'

- Each blade checks primary, 1/2 primary and complementary angles
- Made of medium carbon steel

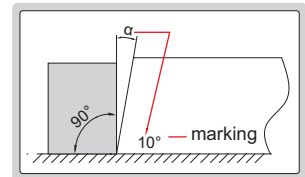
11

ANGLE GAGE

- To check complementary angles
- Made of stainless steel



4806-20



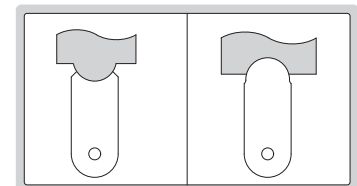
Code	Range (α)	Angle of leaves included	Quantity of leaves	Accuracy
4806-20	1°-45°	1°, 2°, 3°, 4°, 5°, 6°, 7°, 8°, 9°, 10°, 12°, 14°, 16°, 18°, 20°, 25°, 30°, 35°, 40°, 45°	20	±30'

RADIUS GAGES

- Made of medium carbon steel



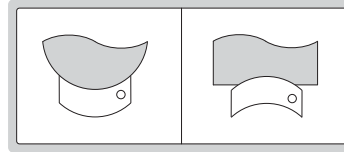
4801-17



Code	Range	Radius of leaves included (mm)	Quantity of leaves (internal + external)
4801-17	1-7mm	1, 1.25, 1.5, 1.75, 2, 2.25, 2.5, 2.75, 3, 3.5, 4, 4.5, 5, 5.5, 6, 6.5, 7	17+17
4801-16	7.5-15mm	7.5, 8, 8.5, 9, 9.5, 10, 10.5, 11, 11.5, 12, 12.5, 13, 13.5, 14, 14.5, 15	16+16
4801-15	15.5-25mm	15.5, 16, 16.5, 17, 17.5, 18, 18.5, 19, 19.5, 20, 21, 22, 23, 24, 25	15+15

RADIUS GAGE

- Made of stainless steel

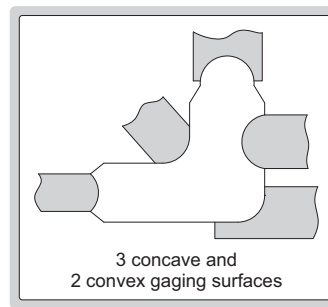


4802-31

Code	Range	Radius of leaves included (mm)	Quantity of leaves
4802-31	25-40mm	25, 25.5, 26, 26.5, 27, 27.5, 28, 28.5, 29, 29.5, 30, 30.5, 31, 31.5, 32, 32.5, 33, 33.5, 34, 34.5, 35, 35.5, 36, 36.5, 37, 37.5, 38, 38.5, 39, 39.5, 40	31 pcs

RADIUS GAGE SET

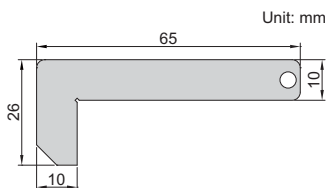
- Each piece has 3 concave and 2 convex gauging surfaces
- Supplied with handle
- Made of medium carbon steel



4804-26

Code	Range	Radius of leaves included (mm)	Quantity of leaves
4804-26	0.5-13mm	0.5, 1, 1.5, 2, 2.5, 3, 3.5, 4, 4.5, 5, 5.5, 6, 6.5, 7, 7.5, 8, 8.5, 9, 9.5, 10, 10.5, 11, 11.5, 12, 12.5, 13	26

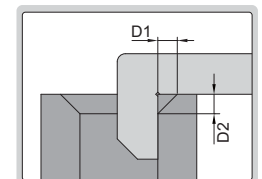
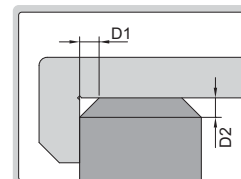
CHAMFER GAGE



- To measure internal and external chamfers
- Made of stainless steel



4844-1



Code	Graduation	Accuracy
4844-1	0.5mm	±0.25mm

DIGITAL CHAMFER GAGES

DATA
OUTPUT

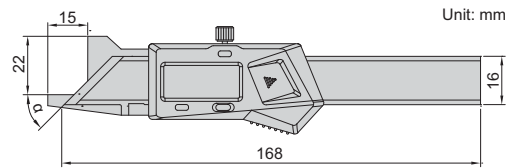
- Measure 30°/45°/60° chamfer dimension
- Resolution: 0.01mm/0.0005"
- Buttons: on/off, zero, mm/inch
- Automatic power off, move the digital unit to turn on power
- Battery CR2032
- Made of stainless steel

With data interface (data output cable code 7315-21, 7302-21, optional)

Code	Range	Accuracy	Chamfer (α)
1180-6	0-10mm/0-0.39"	±0.06mm	45°
1180-63	0-10mm/0-0.39"	±0.06mm	30°
1180-66	0-10mm/0-0.39"	±0.06mm	60°

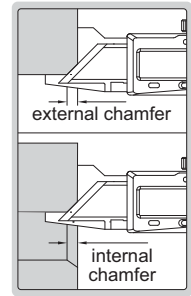


1180-6



Unit: mm

measure chamfer dimension



Built-in wireless

Code	Range	Accuracy	Chamfer (α)
1180-6WL	0-10mm/0-0.39"	±0.06mm	45°
1180-63WL	0-10mm/0-0.39"	±0.06mm	30°
1180-66WL	0-10mm/0-0.39"	±0.06mm	60°

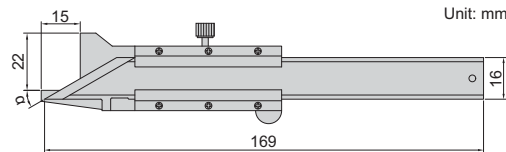
CHAMFER GAGES

11

- Measure 30°/45°/60° chamfer dimension
- Graduation: 0.02mm
- Made of stainless steel
- Satin chrome plated reading surface

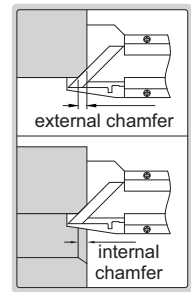


1267-6



Unit: mm

measure chamfer dimension



Code	Range	Accuracy	Chamfer (α)
1267-6	0-10mm	±0.06mm	45°
1267-63	0-10mm	±0.06mm	30°
1267-66	0-10mm	±0.06mm	60°

DIGITAL TAPER SLOT GAGES

DATA
OUTPUT

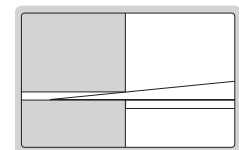
ATTENTION: ACTUAL SLOT WIDTH IS 1/10 OF THE READING

- Measuring opening, slot width
- Resolution: 0.01mm/0.0005"
- Buttons: on/off, zero, mm/inch
- Automatic power off, move the digital unit to turn on power
- Battery CR2032
- Made of stainless steel



1160-10

measure slot width

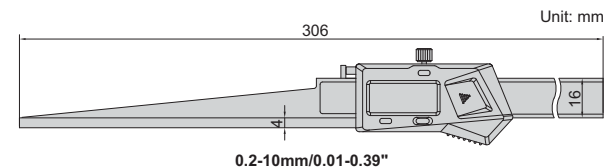


With data interface (data output cable code 7315-21, 7302-21, optional)

Code	Range	Accuracy	h
1160-10	0.2-10mm/0.01-0.39"	±0.03mm	—
1160-20	10-20mm/0.39-0.79"	±0.05mm	10mm
1160-30	20-30mm/0.79-1.18"	±0.05mm	20mm
1160-40	30-40mm/1.18-1.58"	±0.05mm	30mm

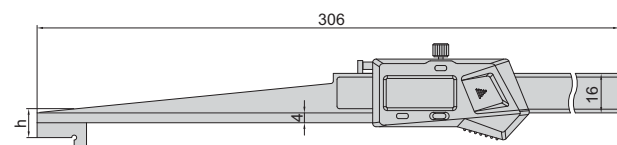
Built-in wireless

Code	Range	Accuracy	h
1160-10WL	0.2-10mm/0.01-0.39"	±0.03mm	—
1160-20WL	10-20mm/0.39-0.79"	±0.05mm	10mm
1160-30WL	20-30mm/0.79-1.18"	±0.05mm	20mm
1160-40WL	30-40mm/1.18-1.58"	±0.05mm	30mm



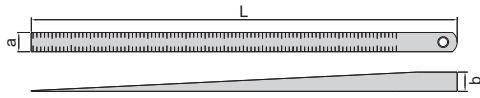
Unit: mm

0.2-10mm/0.01-0.39"



10-20mm/0.39-0.79" up to 30-40mm/1.18-1.58"

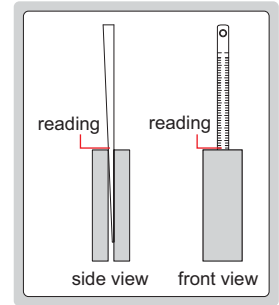
TAPER SLOT GAGES



- For quick measurement of slot width
- Satin chrome plated reading surface
- Made of stainless steel

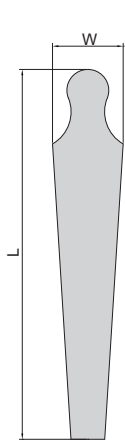


4630-1



Code	Range	Graduation	Accuracy	L	a	b
4630-3	0.4-6mm	0.05mm	±0.04mm	164mm	12.5mm	6.5mm
4630-1	0.5-10mm	0.05mm	±0.07mm	220mm	10mm	10.5mm
4630-2	0.5-15mm	0.1mm	±0.08mm	184mm	12.5mm	16.5mm

TAPER GAGES



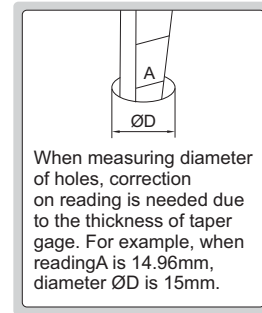
front



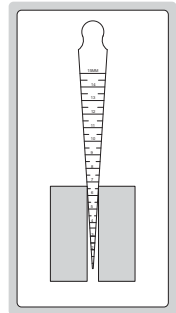
back

4833-2

measure diameter of hole



measure slot width



- Measure opening, slot width, hole diameter, etc.
- Diameter correction table on the back (only for 4833-1, 4833-2)
- Made of stainless steel

Code	Range	Graduation	Accuracy	L	W
4833-1	0.8-15mm	0.1mm	±0.05mm	146	17
4833-2	15-30mm	0.1mm	±0.05mm	159	30.4
4833-3	30-45mm	0.1mm	±0.05mm	166	45.4
4833-4	45-60mm	0.1mm	±0.05mm	170	60.5

TAPER GAGE SET



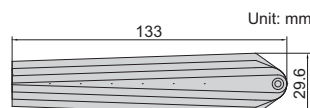
front

back

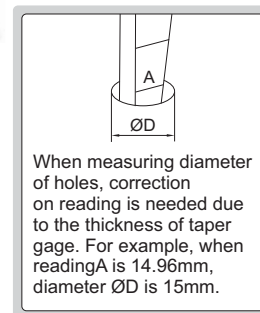
4837-1

- Include 4 pcs (1~8mm, 8~15mm, 15~22mm, 22~29mm)
- Measure opening, slot width, hole diameter, etc.
- Diameter correction table on the back
- Made of stainless steel

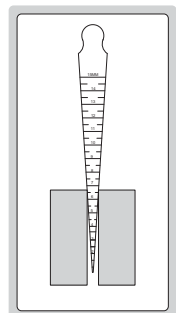
Code	Range	Graduation	Accuracy
4837-1	1-29mm	0.05mm	±0.05mm



measure diameter of hole



measure slot width



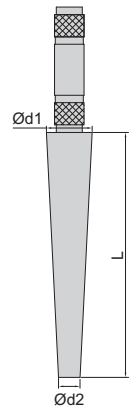
TAPER BORE GAGES

- Quick measurement of bore diameter
- Hardened steel, HRC50-58
- Satin chrome plated surface
- Aluminium oxidized handle

Code	Range	Graduation	Accuracy	L	Ød1	Ød2
4852-1	1-6.5mm	0.1mm	±0.05mm	62.5	7	0.8
4852-3	3-16mm	0.1mm	±0.05mm	143	17	2.8
4852-15	15-30mm	0.1mm	±0.05mm	165	31	14.7
4852-30	30-45mm	0.1mm	±0.05mm	165	46	29.6
4852-45	45-60mm	0.1mm	±0.05mm	167	61	44.3

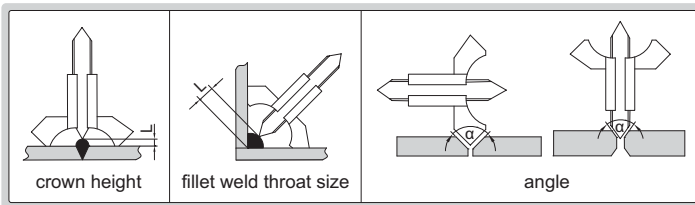


4852-15



WELDING GAGE

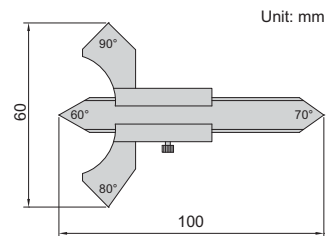
11



4830

- Made of stainless steel
- Satin chrome plated reading surface

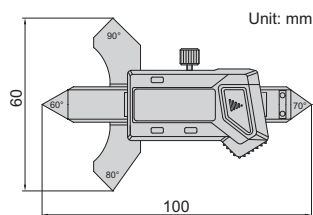
Code	Measurement	Range	Graduation	Accuracy
4830	crown height	0-8mm	0.1mm	±0.1mm
	fillet weld throat size	0-20mm	0.1mm	±0.3mm
	angle	60°, 70°, 80°, 90°	—	±1°



Unit: mm

DIGITAL WELDING GAGE

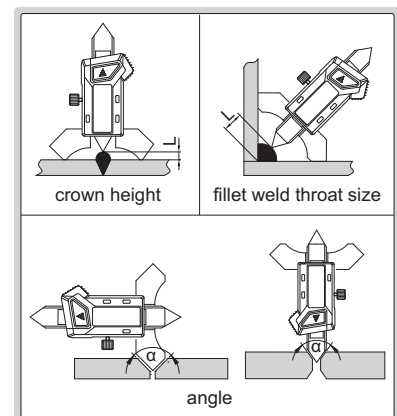
ATTENTION:
NO DATA OUTPUT



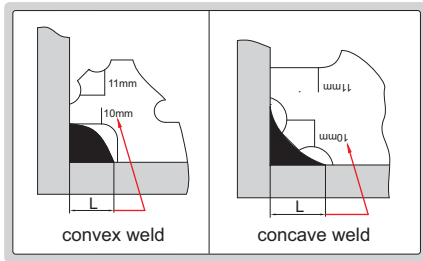
4831-20A

- Buttons: zero, mm/inch, on/off
- Battery LR44
- Made of stainless steel

Code	Measurement	Range	Resolution	Accuracy
4831-20A	crown height	0-7mm	0.01mm/0.0005"	±0.03mm
	fillet weld throat size	0-20mm	0.01mm/0.0005"	±0.1mm
	angle	60°, 70°, 80°, 90°	—	±1°



FILLET WELDING GAGES



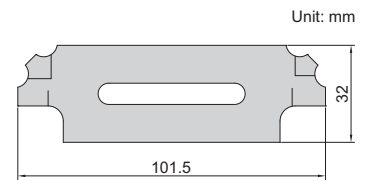
4836-1



4836-2

- Measure concave and convex weld sizes
- 7 blades are included
- Made of stainless steel

Code	Size	Accuracy
4836-1	3mm, 4mm, 5mm, 6mm, 8mm, 9mm, 10mm, 11mm, 12mm, 14mm, 16mm, 19mm, 22mm, 25mm	±0.5mm
4836-2	1/8" (3.2mm), 3/16" (4.8mm), 1/4" (6.4mm), 5/16" (7.9mm), 3/8" (9.5mm), 7/16" (11.1mm), 1/2" (12.7mm), 5/8" (15.9mm), 3/4" (19.1mm), 7/8" (22.2mm), 1" (25.4mm)	±0.02" (0.5mm)



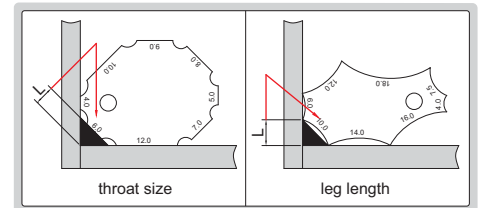
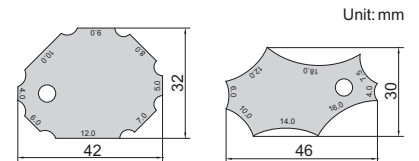
11

FILLET WELDING GAGE



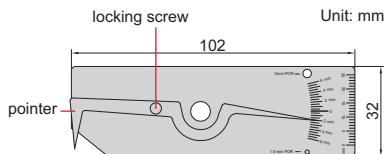
4832-1

- Made of stainless steel
- Sizes marked on both faces



Code	Throat size	Leg length	Accuracy
4832-1	4, 5, 6, 7, 8, 9, 10, 12mm	4, 6, 7.5, 10, 12, 14, 16, 18mm	±0.5mm

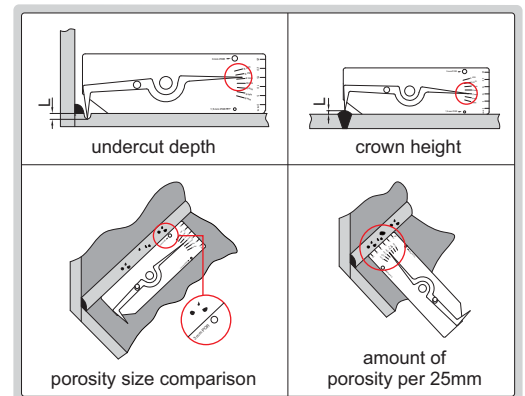
WELDING GAGE



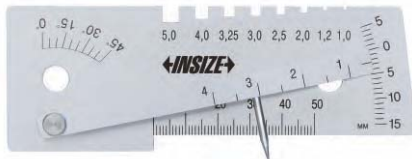
4834-1

- Pointer can be locked for later reference
- Made of stainless steel

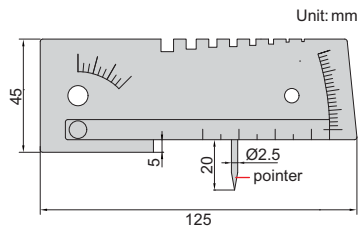
Code	Measurement	Range	Graduation	Accuracy
4834-1	undercut depth	0-6mm	0.5mm	±0.5mm
	crown height	0-6mm	0.5mm	±0.5mm
	porosity size comparison	1.5mm, 3mm	—	±0.2mm
	amount of porosity per 25mm	25mm	1mm	—



WELDING GAGE

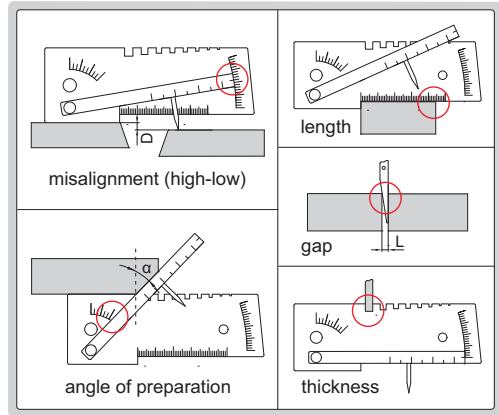


4848-1



Unit: mm

- Made of stainless steel

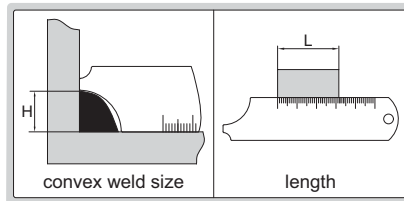


Code	Measurement	Range	Graduation	Accuracy
4848-1	misalignment (high-low)	-5mm~+15mm	1mm	±0.5mm
	angle of preparation	0°-45°	5°	±2.5°
	length	0-50mm	1mm	±0.5mm
	gap	1-4mm	0.5mm	±0.25mm
	thickness	1, 1.2, 2.0, 2.5, 3.0, 3.25, 4.0, 5.0mm	—	±0.1mm

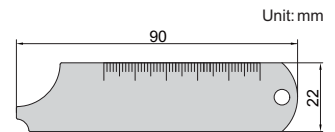
FILLET WELDING GAGE

11

- Measure convex weld sizes
- 3 blades are included
- Made of stainless steel



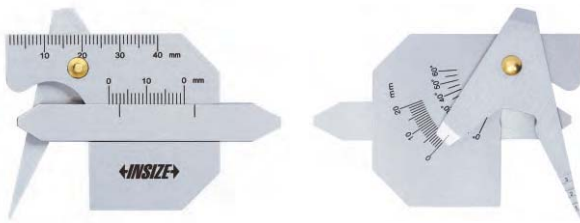
4847-1



Unit: mm

Code	Measurement	Range	Graduation	Accuracy
4847-1	convex weld size	4, 6, 8, 10, 12, 14mm	—	±0.5mm
	length	0 - 50mm	1mm	±0.5mm

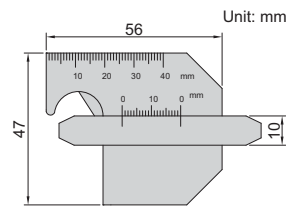
WELDING GAGE



front

6832-1

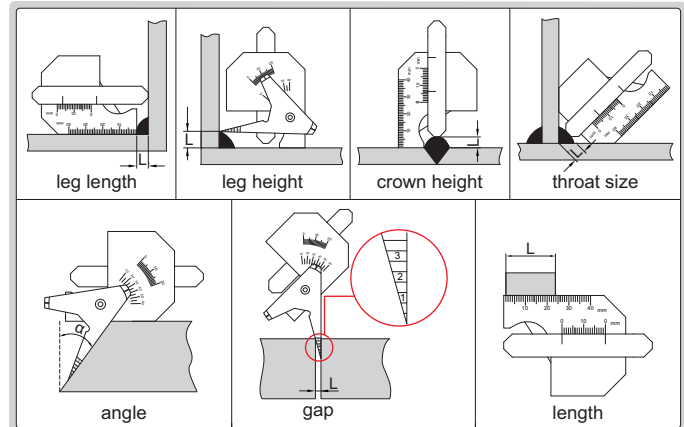
back



Unit: mm

- Made of stainless steel
- Satin chrome plated surface

Code	Measurement	Range	Graduation	Accuracy
6832-1	leg length	0-20mm	1mm	±0.3mm
	leg height	0-20mm	1mm	±0.3mm
	crown height	0-20mm	1mm	±0.3mm
	throat size	0-10mm	1mm	±0.3mm
	angle	0°-60°	5°	±1°
	gap	1-3.5mm	0.5mm	±0.2mm
	length	0-40mm	1mm	±0.3mm



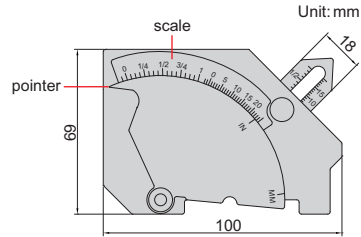
WELDING GAGE



front

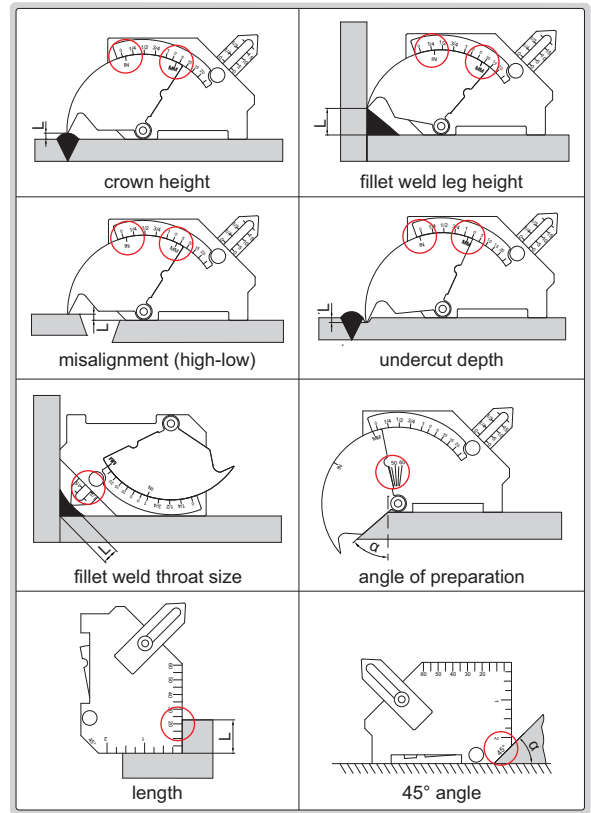
back

4835-1



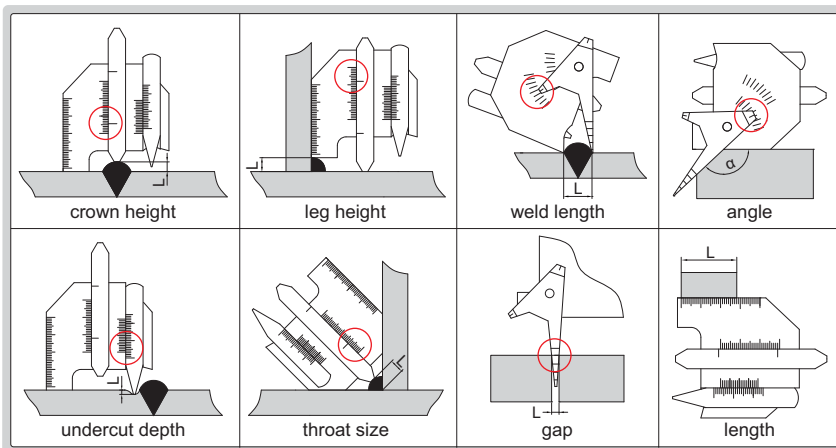
- Adjustable scale to compensate pointer wear
- Made of stainless steel

Code	Measurement	Range	Graduation	Accuracy
4835-1	crown height	0-25mm (0-1")	1mm (1/16")	±0.5mm
	fillet weld leg height	0-25mm (0-1")	1mm (1/16")	±0.5mm
	misalignment (high-low)	0-25mm (0-1")	1mm (1/16")	±0.5mm
	undercut depth	0-2mm (0-1/8")	1mm (1/16")	±0.5mm
	fillet weld throat size	0-20mm (0-3/4")	1mm (1/16")	±0.5mm
	angle of preparation	0-60°	5°	±1°
	length	0-60mm (0-2")	1mm (1/16")	±0.5mm
	45° angle	—	—	±1°



11

WELDING GAGES



- Made of stainless steel

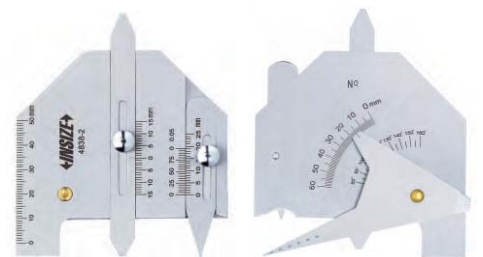
Measurement	Range	Code 4838-1			Code 4838-2		
		Graduation	Accuracy	Range	Graduation	Accuracy	
crown height	0-10mm	1mm	±0.5mm	0-15mm	1mm	±0.5mm	
leg height	0-14mm	1mm	±0.5mm	0-15mm	1mm	±0.5mm	
undercut depth	0-5mm	0.05mm	±0.05mm	0-5mm	0.05mm	±0.05mm	
throat size	0-13mm	1mm	±0.5mm	0-13mm	1mm	±0.5mm	
weld length	0-40mm	1mm	±1mm	0-60mm	1mm	±1mm	
angle	90°-150°	5°	±1°	80°-160°	5°	±1°	
gap	0.5-5mm	1mm	±0.5mm	1-6mm	1mm	±0.5mm	
length	0-40mm	1mm	±0.5mm	0-50mm	1mm	±0.5mm	
LxW	62x77mm			99x84mm			



front

4838-1

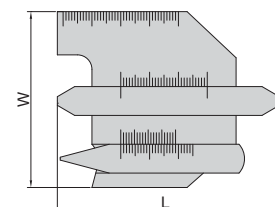
back



front

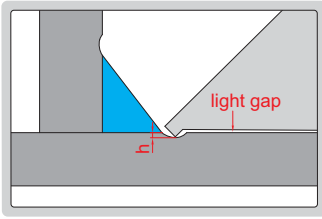
4838-2

back



WELDING UNDERCUT GAGE

application



when there is a light gap, $h < 0.25\text{mm}$;
when there is no light gap, $h \geq 0.25\text{mm}$

- Measure undercut
- Calibration block is included
- Made of stainless steel

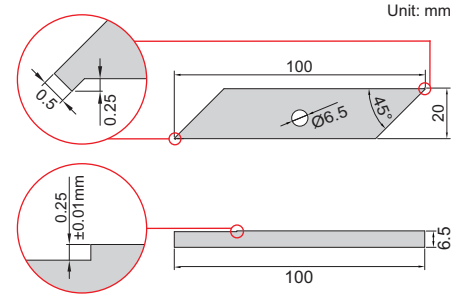


4849-1

calibration block (included)

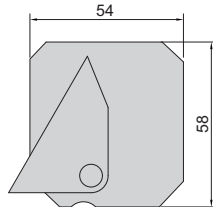


Code
4849-1



WELDING GAGE

Unit: mm

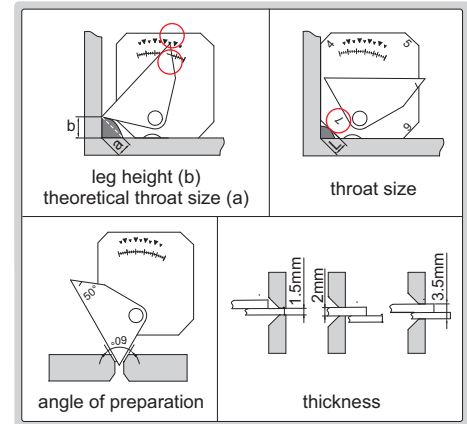


- Made of stainless steel



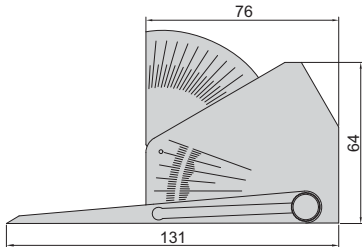
4850-1

Code	Measurement	Range	Graduation	Accuracy
4850-1	leg height (b)	0-18mm	1mm	±0.5mm
	theoretical throat size (a)	2-12mm	1mm	±0.5mm
	throat size	4, 5, 6, 7mm	—	±0.5mm
	angle of preparation	50°, 60°	—	±1°
	thickness	1.5, 2, 3.5mm	—	±0.2mm



FILLET WELDING GAGE

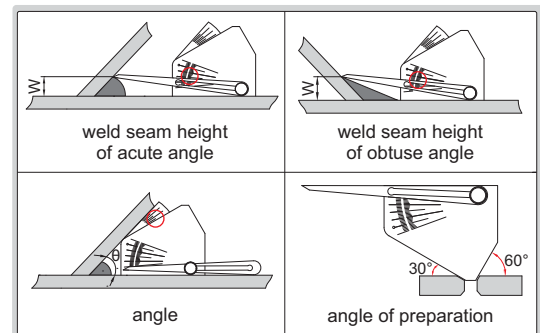
Unit: mm



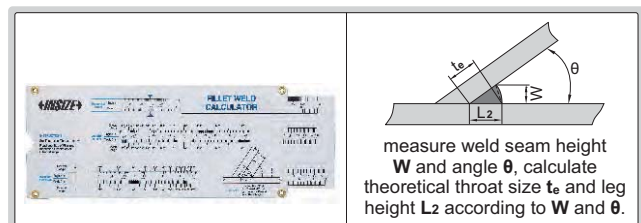
4846-1

- Calculating card is included
- Made of stainless steel

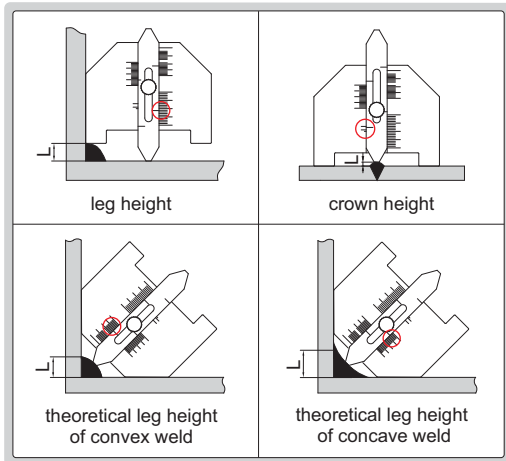
Code	Measurement	Range	Graduation	Accuracy
4846-1	weld seam height W	0-50mm/0-2"	2mm/0.05"	±1mm
	angle θ	30°-90°	2.5°	±1°
	60° angle	—	—	±0.5°



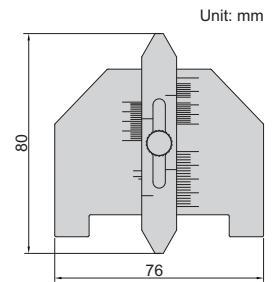
calculating card (included)



WELDING GAGE



4851-1

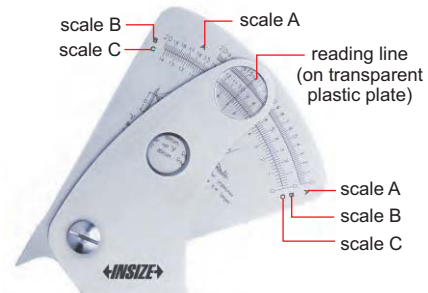
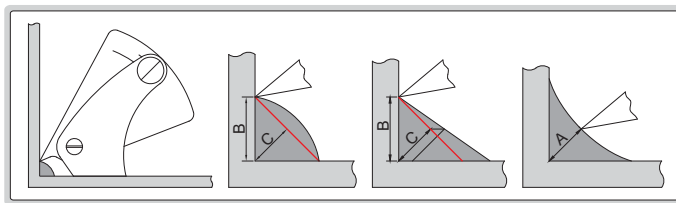


Code	Measurement	Range	Graduation	Accuracy
4851-1	leg height	0-20mm	1mm	±0.5mm
	crown height	0-3mm	—	±0.5mm
	theoretical leg height of convex weld	0-20mm	1mm	±0.5mm
	theoretical leg height of concave weld	0-20mm	1mm	±0.5mm

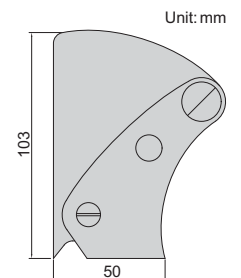
- Made of stainless steel

WELDING GAGE

- Made of stainless steel



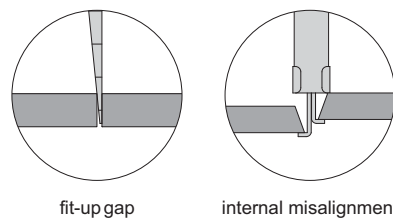
4840-1



Code	Graduation	Accuracy
4840-1	0.2mm	±0.3mm

PIPE WELDING GAGE

- Made of stainless steel

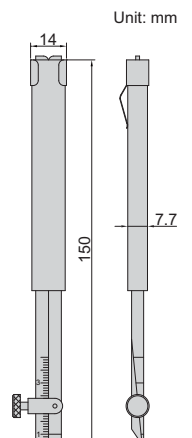


fit-up gap

internal misalignment

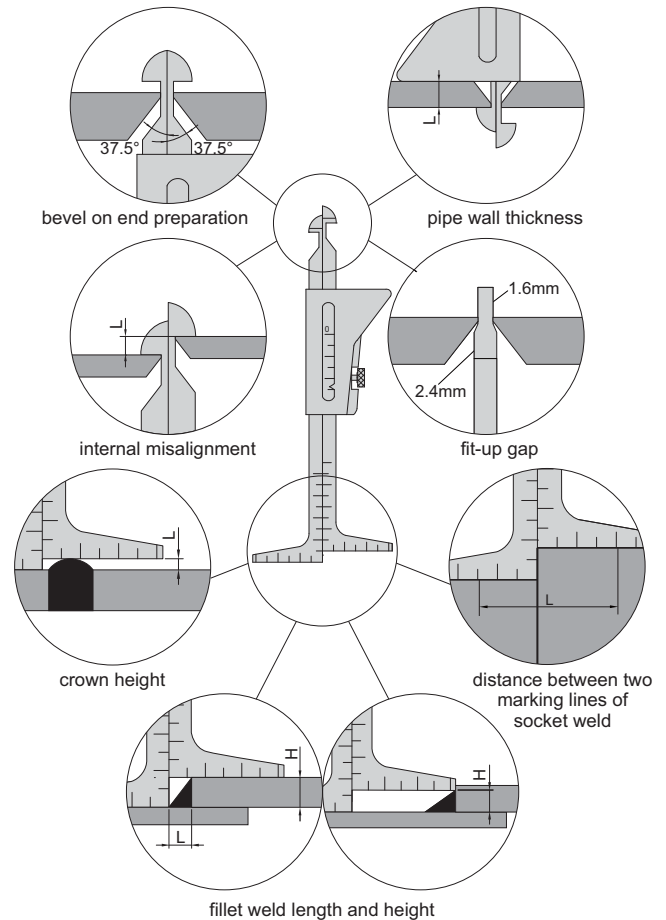
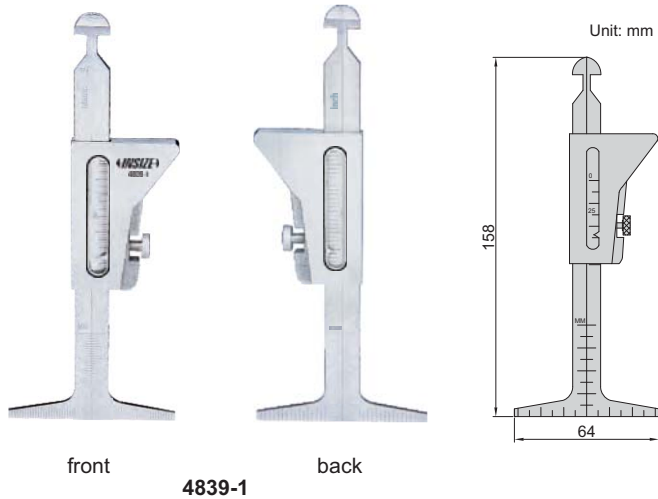


4841-1



Code	Measurement	Range	Graduation	Accuracy
4841-1	internal misalignment	0-30mm	1mm	±0.5mm
	fit-up gap	0.7-4mm	0.1mm	±0.1mm

PIPE WELDING GAGE



- Made of stainless steel

Code	Measurement	Range	Graduation	Accuracy
4839-1	bevel on end preparation	37.5°	—	±1°
	pipe wall thickness	0-45mm (0~1-3/4")	1mm (1/16")	±0.5mm
	internal misalignment	0-35mm (0~1-3/8")	1mm (1/32")	±0.5mm
	fit-up gap	1.6mm, 2.4mm	—	±0.1mm
	crown height	0-35mm (0~1-3/8")	1mm (1/32")	±0.5mm
	distance between two marking lines of socket weld	0-60mm (0~2-3/8")	1mm (1/16")	±0.5mm
	fillet weld length	0-30mm (0~1-1/4")	1mm (1/16")	±0.5mm
	fillet weld height	0-35mm (0~1-3/8")	1mm (1/32")	±0.5mm

6-PIECE WELDING GAGE SET

- Includes:
 - 1) Welding gage (code **4834-1**)
 - 2) Fillet welding gage, size 3~25mm, 7 blades (code **4836-1**)
 - 3) Pipe welding gage (code **4841-1**)
 - 4) Telescoping inspection mirror, size of mirror Ø32mm, length 178~505mm (code **7160-1**)
 - 5) Pocket rule with sliding clip, range 150mm/6", graduation 1mm, 1/64" (code **7119-150**)
 - 6) LED flashlight (code **ISGF-0501**)



Code
5064

5064

7-PIECE WELDING GAGE SET

- Includes:
 - 1) Welding gage (code **4834-1**)
 - 2) Welding gage (code **4851-1**)
 - 3) Pipe welding gage (code **4839-1**)
 - 4) Outside micrometer, range 0-25mm, graduation 0.01mm (code **3203-25A**)
 - 5) Telescoping inspection mirror, size of mirror Ø32mm, length 178~505mm (code **7160-1**)
 - 6) Magnifier with illumination, magnification 4X (code **7513-4**)
 - 7) Steel rule, range 150mm/6", graduation 0.5mm, 1mm, 1/64", 1/32", 1/16" (code **7110-150**)

Code
5071



5071

7-PIECE WELDING GAGE SET

- Includes:
 - 1) Welding gage (code **4834-1**)
 - 2) Welding gage (code **4851-1**)
 - 3) Fillet welding gage, size 3~25mm, 7 blades (code **4836-1**)
 - 4) Outside micrometer, range 0-25mm, graduation 0.01mm (code **3203-25A**)
 - 5) Digital caliper, range 0-150mm/0-6", resolution 0.01mm/0.005" (code **1108-150**)
 - 6) Pocket rule with sliding clip, range 150mm/6", graduation 1mm, 1/64" (code **7119-150**)
 - 7) Magnifier with illumination, magnification 4X (code **7513-4**)

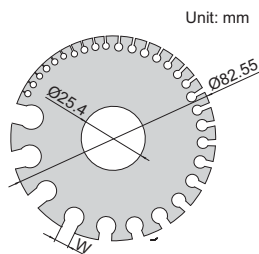
Code
5072



5072

11

AMERICAN STANDARD WIRE GAGE



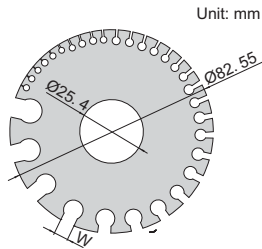
4808

- For gaging wire
- Hardened and satin chrome finish

Code	Range
4808	0-36 (8.250-0.127mm/0.3249-0.0050")

No.	W	No.	W
0	8.250mm/0.3249"	18	1.020mm/0.0403"
1	7.350mm/0.2893"	19	0.912mm/0.0359"
2	6.540mm/0.2576"	20	0.813mm/0.0320"
3	5.830mm/0.2294"	21	0.724mm/0.0285"
4	5.190mm/0.2043"	22	0.643mm/0.0253"
5	4.620mm/0.1819"	23	0.574mm/0.0226"
6	4.110mm/0.1620"	24	0.511mm/0.0201"
7	3.670mm/0.1443"	25	0.440mm/0.0179"
8	3.260mm/0.1285"	26	0.404mm/0.0159"
9	2.910mm/0.1144"	27	0.361mm/0.0142"
10	2.590mm/0.1019"	28	0.320mm/0.0126"
11	2.300mm/0.0907"	29	0.287mm/0.0113"
12	2.050mm/0.0808"	30	0.254mm/0.0100"
13	1.820mm/0.0720"	31	0.226mm/0.0089"
14	1.630mm/0.0641"	32	0.203mm/0.0080"
15	1.450mm/0.0571"	33	0.180mm/0.0071"
16	1.290mm/0.0508"	34	0.160mm/0.0063"
17	1.150mm/0.0453"	35	0.142mm/0.0056"
		36	0.127mm/0.0050"

U.S. STANDARD SHEET METAL GAGE



4809

- For gaging sheet metal
- Hardened and satin chrome finish

Code	Range
4809	0-36 (7.938-0.179mm/0.3125-0.0070")

No.	W
0	7.938mm/0.3125"
1	7.144mm/0.2813"
2	6.747mm/0.2656"
3	6.350mm/0.2500"
4	5.953mm/0.2344"
5	5.556mm/0.2188"
6	5.159mm/0.2031"
7	4.763mm/0.1875"
8	4.366mm/0.1719"
9	3.969mm/0.1563"
10	3.572mm/0.1406"
11	3.175mm/0.1250"
12	2.778mm/0.1094"
13	2.381mm/0.0938"
14	1.984mm/0.0781"
15	1.786mm/0.0703"
16	1.588mm/0.0625"
17	1.429mm/0.0563"

No.	W
18	1.270mm/0.0500"
19	1.111mm/0.0438"
20	0.953mm/0.0375"
21	0.873mm/0.0344"
22	0.794mm/0.0313"
23	0.714mm/0.0281"
24	0.635mm/0.0250"
25	0.556mm/0.0219"
26	0.476mm/0.0188"
27	0.437mm/0.0172"
28	0.397mm/0.0156"
29	0.357mm/0.0141"
30	0.318mm/0.0125"
31	0.278mm/0.0109"
32	0.258mm/0.0102"
33	0.238mm/0.0094"
34	0.218mm/0.0086"
35	0.198mm/0.0078"
36	0.179mm/0.0070"

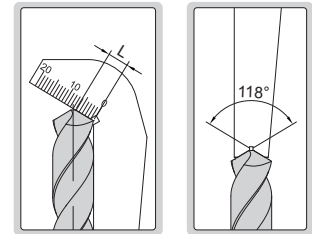
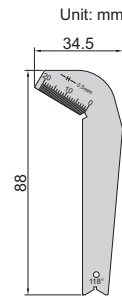
11

DRILL POINT GAGE

- For twist drills with 118° angle, to check if the center of tip is concentric with the drill body
- Made of stainless steel



4843-1



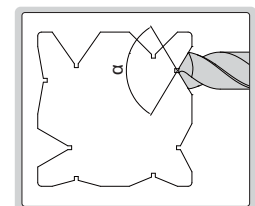
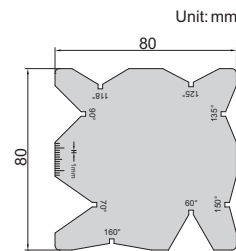
Code	Accuracy	
	Angle	Length
4843-1	±0.5°	±0.5mm

DRILL ANGLE GAGE

- Check drills with angle 60°, 70°, 90°, 118°, 125°, 135°, 150° or 160°
- Made of stainless steel

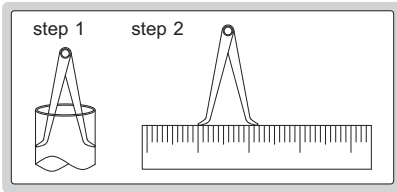


4842-1



Code	Accuracy
4842-1	±0.5°

INSIDE CALIPERS

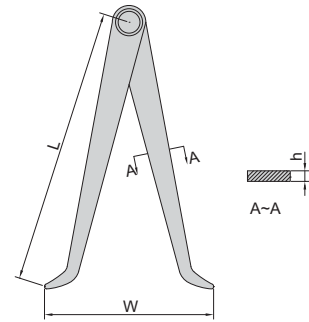


- Made of carbon steel

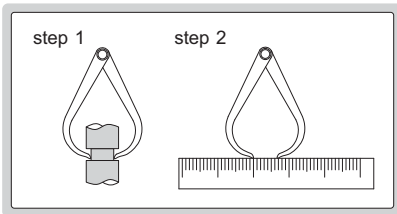
Code	Size (L)	Range (W)	h
7240-150	150mm	17-150mm	2mm
7240-200	200mm	17-200mm	3mm
7240-300	300mm	18-300mm	3mm



7240-150



OUTSIDE CALIPERS

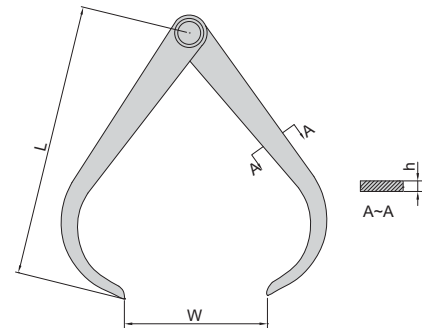


- Made of carbon steel

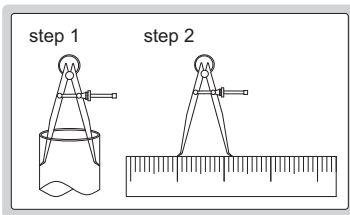
Code	Size (L)	Range (W)	h
7241-150	150mm	0-150mm	2mm
7241-200	200mm	0-200mm	3mm
7241-300	300mm	0-300mm	3mm



7241-150



INSIDE SPRING CALIPERS

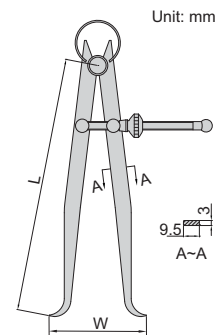


- Made of carbon steel

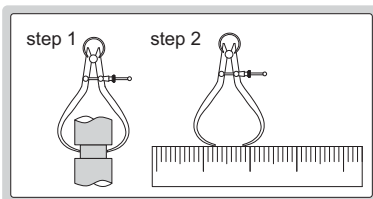
Code	Size (L)	Range (W)
7261-150	150mm	20-170mm
7261-200	200mm	22-220mm
7261-250	245mm	30-270mm
7261-300	300mm	30-320mm



7261-150



OUTSIDE SPRING CALIPERS

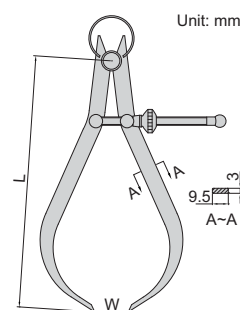


- Made of carbon steel

Code	Size (L)	Range (W)
7262-150	155mm	0-140mm
7262-200	210mm	0-210mm
7262-250	265mm	0-270mm
7262-300	310mm	0-320mm

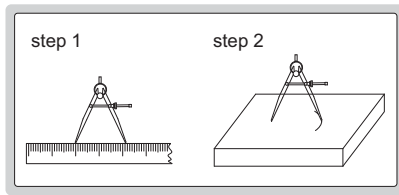


7262-150



SPRING DIVIDERS

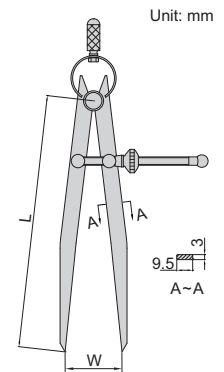
- Made of carbon steel
- Hardened points



Code	Size (L)	Range (W)
7260-150	150mm	0-150mm
7260-200	200mm	0-210mm
7260-250	245mm	0-260mm
7260-300	300mm	0-320mm



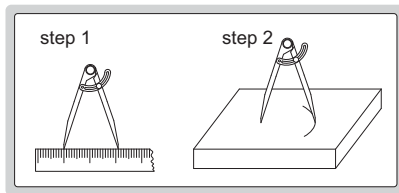
7260-150



Unit: mm

DIVIDERS

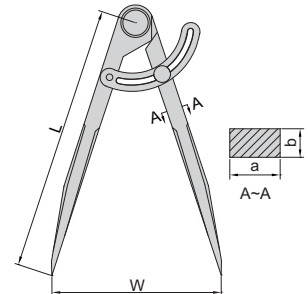
- Made of carbon steel
- Hardened points



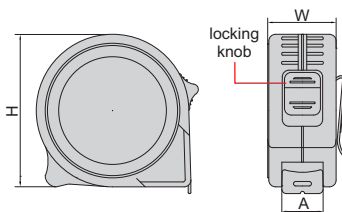
Code	Size (L)	Range (W)	a	b
7247-150	150mm	0-140mm	8.5mm	7mm
7247-200	200mm	0-190mm	10mm	7mm
7247-300	300mm	0-290mm	12mm	7mm



7247-150



MEASURING TAPES



- Non-glare nylon surface for wear resistance

Code	Range	Graduation	Width of tape A	W	H
7140-3	0-3m	1mm	16mm	28mm	62mm
7140-5	0-5m	1mm	19mm	30mm	68mm
7140-8	0-8m	1mm	25mm	38mm	78mm



7140-5

graduation

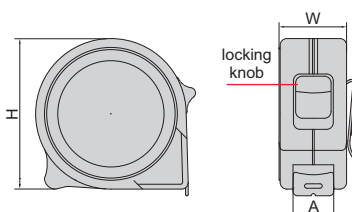


EG II

packaging



MEASURING TAPE (BASIC TYPE)



- Non-glare nylon coating tape, wear resistance

Code	Range	Graduation	Width of tape A	W	H
7142-5	0-5m/0-16ft	1mm, 1/16"	19mm	31mm	64mm



7142-5

graduation



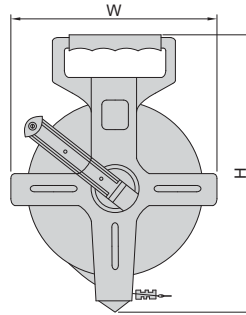
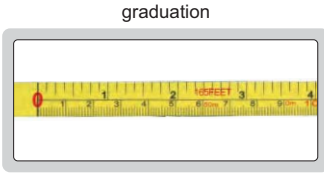
EG II

packaging



EG II

LONG MEASURING TAPE



7143-50

- High tensile strength fibreglass tape
- Nylon coating tape, wear resistance

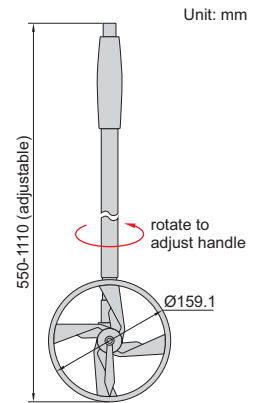
Code	Range	Graduation	Width of tape	W	H
7143-50	0-50m/0-165ft	1mm, 1/8"	13mm	220mm	320mm

MEASURING WHEEL (BASIC TYPE)

- ABS plastic frame, wear-resistant PU tire
- Three-section adjustable handle



7144-1



Unit: mm

11

Code	Range	Resolution
7144-1	0.1-9999.9m	0.1m

MEASURING WHEEL

- ABS plastic frame, wear-resistant PU tire
- Two-section foldable handle



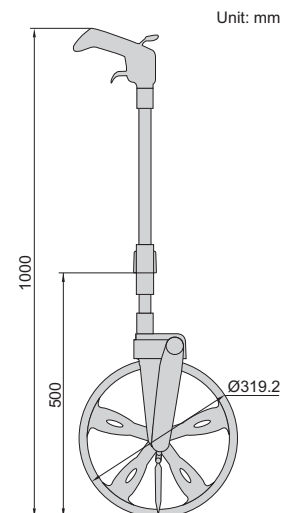
after folding



backpack (included)



7145-1



Unit: mm

Code	Range	Resolution
7145-1	0.1-9999.9m	0.1m

RIGID RULE

- Rigid rules
- With groove on the back, suitable for combination square set (2278 series)
- Satin chrome plated

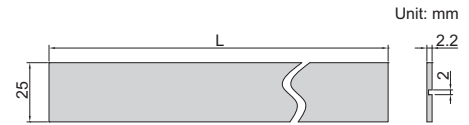


7113-300A



groove on the back

Code	Range	Graduation		Accuracy	L
		front	back		
7113-300A	300mm/12"	0.5mm and 1/32"	1mm and 1/64"	±0.15mm	300mm



Unit: mm

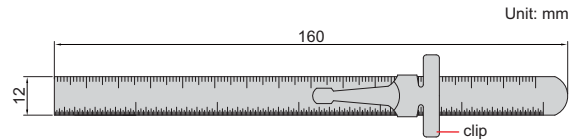
POCKET RULE WITH SLIDING CLIP

- With sliding clip, clip can be inserted in the pocket, also can be used as depth gage base
- Inch/metric conversion table on the back
- Made of stainless steel



7119-150

Code	Range	Graduation	Accuracy
7119-150	150mm/6"	1mm, 1/64"	±0.15mm



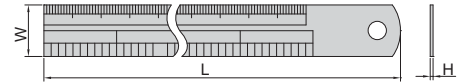
Unit: mm

STEEL RULES (ECONOMIC TYPE)

ATTENTION:
LOW ACCURACY



7110-300



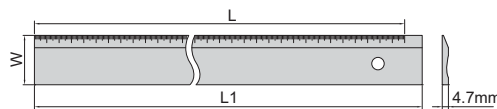
(mm)

Code	Range	Accuracy	L	W	H	Remark
7110-150	150mm/6"	±0.18mm	170	18	1.0	graduation on front and back
7110-200	200mm/8"	±0.18mm	220	18	1.0	graduation on front and back
7110-300	300mm/12"	±0.27mm	330	25	1.0	graduation on front and back
7110-3001	300mm/12"	±0.27mm	325	30	1.0	graduation on front and back
7110-500	500mm/20"	±0.27mm	530	30	1.2	graduation on front and back
7110-600	600mm/24"	±0.45mm	630	30	1.2	graduation on front and back
7110-1000	1000mm/40"	±0.45mm	1040	32	1.5	graduation on front and back
7110-1200	1200mm/48"	±0.63mm	1240	35	1.8	graduation on front
7110-1500	1500mm/60"	±0.63mm	1550	38	1.8	graduation on front
7110-2000	2000mm/80"	±0.80mm	2065	40	2.0	graduation on front

- Graduation: 0.5mm, 1mm, 1/64", 1/32", 1/16"
- Rigid rules
- Made of stainless steel
- Non-glare surface

ALUMINUM RULES

- Made of aluminum, oxidized surface



Code	Range (L)	Graduation	Accuracy	L1	W
7123-300	300mm	1mm	±0.5mm	321mm	50mm
7123-600	600mm	1mm	±0.9mm	624mm	50mm
7123-1000	1000mm	1mm	±0.9mm	1024mm	50mm



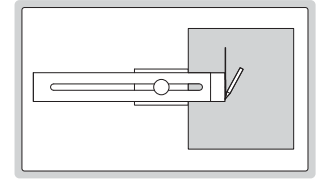
7123-300

MARKING GAGES

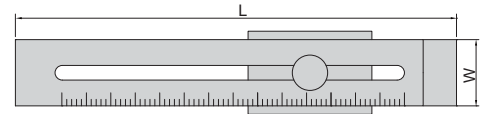


7120-200A

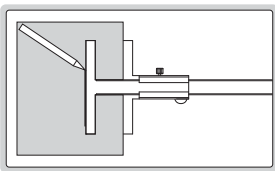
- Made of carbon steel
- Satin chrome plated



Code	Range	Graduation	Accuracy	L	W
7120-200A	0-200mm	0.1mm	±0.1mm	250mm	40mm
7120-250A	0-250mm	0.1mm	±0.1mm	300mm	40mm
7120-300A	0-300mm	0.1mm	±0.1mm	350mm	40mm



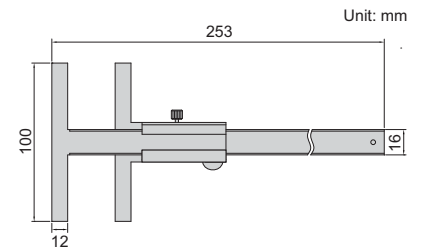
T-SHAPE MARKING GAGE



1275-150B

- Made of stainless steel
- Satin chrome plated reading surface

Code	Range	Graduation	Accuracy
1275-150B	0-150mm	0.02mm	±0.04mm

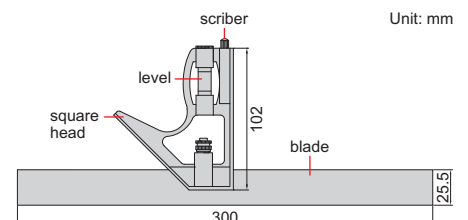
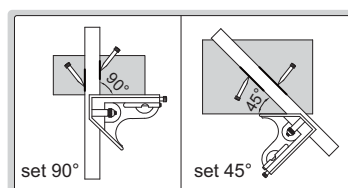


COMBINATION SQUARE (ECONOMIC TYPE)

- Square head (made of zinc): set the blade at 90° or 45° to an edge of a workpiece accuracy: ±0.5°
- Blade (made of stainless steel): range: 300mm/12", graduation: 1mm and 1/32" on front face, 1mm and 1/16" on back face



2276-300



Code
2276-300

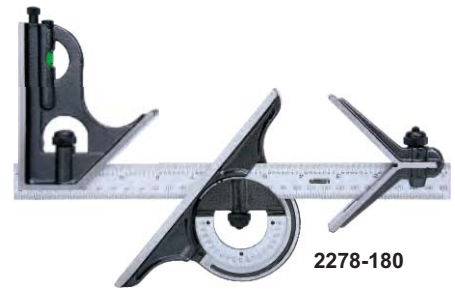
COMBINATION SQUARE SETS



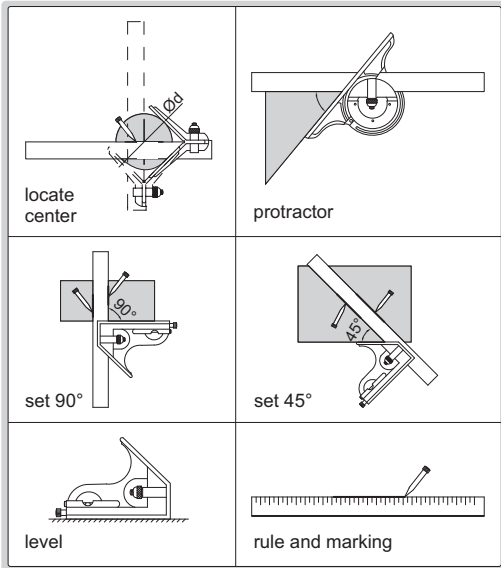
2278-2



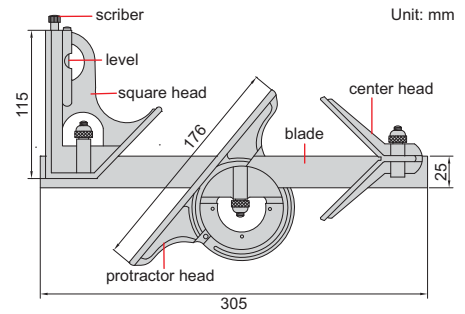
2278-3



2278-180



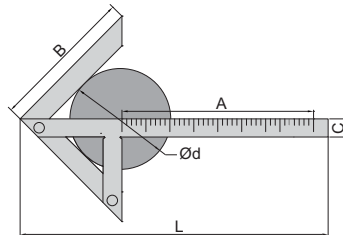
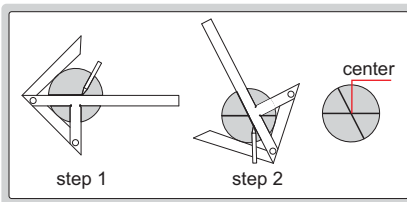
- Center head (made of cast iron): to locate center of cylinders with diameter (Ød): 30-100mm accuracy: ±0.15mm
- Protractor head (made of cast iron): set the blade at desired angle to an edge of a workpiece, and can be used to measure angles range: 0-180° accuracy: ±20min.
- Square head (made of cast iron): set the blade at 90° or 45° to an edge of a workpiece accuracy: ±8min for 90° square, ±10min for 45° square
- Blade (made of stainless steel): range: 300mm/12", graduation: 0.5mm and 1/32" on front face, 1mm and 1/64" on back face
- Optional accessory: rigid rule (code 7113)



Code	Remark
2278-2	2-piece set
2278-3	3-piece set
2278-180	4-piece set

11

CENTER MARKING GAGES



7205-100

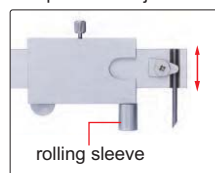
Code	Size (AxB)	Diameter of shafts (Ød)	Accuracy	C	L
7205-100	100x70mm	4-90mm	±0.15mm	12mm	153mm
7205-150	150x130mm	4-190mm	±0.15mm	15mm	245mm
7205-200	200x150mm	6-220mm	±0.15mm	15mm	310mm
7205-300	300x180mm	6-270mm	±0.15mm	20mm	435mm

- Marking the center of round plates and shafts
- Made of stainless steel
- Satin chrome plated

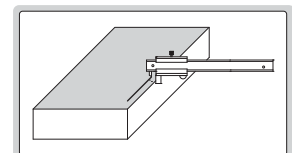
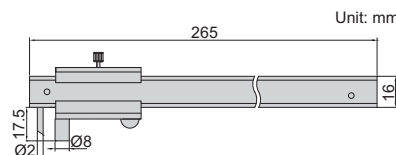
SCRIBING CALIPER

- Made of stainless steel
- Satin chrome plated reading surface
- Carbide scribe tip
- Optional accessory: carbide scribe tip (code SP-SCRIBER-7202)

the position of scribe tip can be adjusted



7202-200A



Code	Range	Graduation	Accuracy
7202-200A	0-200mm/0-8"	0.1mm, 1/128"	±0.1mm

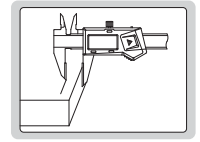
DATA OUTPUT

DIGITAL SCRIBING CALIPERS

- The carbide-tipped jaws facilitate scribing on workpieces
- Resolution: 0.01mm/0.0005"
- Buttons: on/off, zero, mm/inch
- Automatic power off, move the digital unit to turn on power
- Battery CR2032
- Made of stainless steel



1166-150A

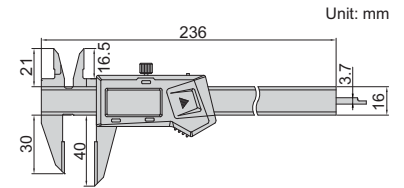


With data interface (data output cable code 7315-21, 7302-21, optional)

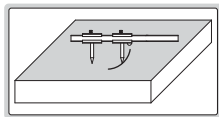
Code	Range	Accuracy
1166-150A	0-150mm/0-6"	±0.03mm

Built-in wireless

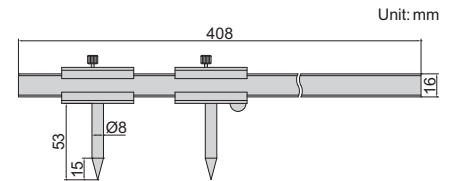
Code	Range	Accuracy
1166-150AWL	0-150mm/0-6"	±0.03mm



SCRIBING CALIPER



7203-300A



- Made of stainless steel
- Satin chrome plated reading surface
- Hardened scriber tips

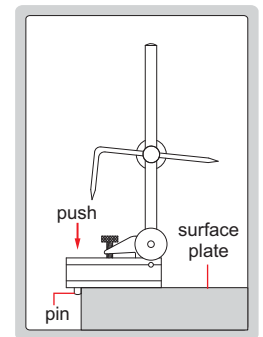
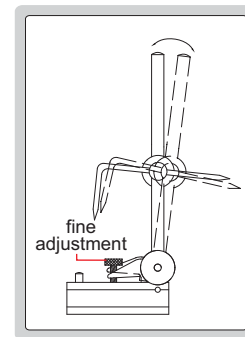
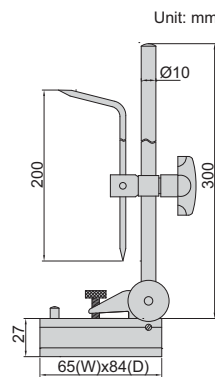
Code	Range	Graduation	Accuracy
7203-300A	51-300mm	0.1mm	±0.1mm

HEIGHT SCRIBER

- Grooved bottom for cylinders
- Two pins to be set against the edge of surface plate



6990-300A



SCRIBERS

- Nickel plated



7230

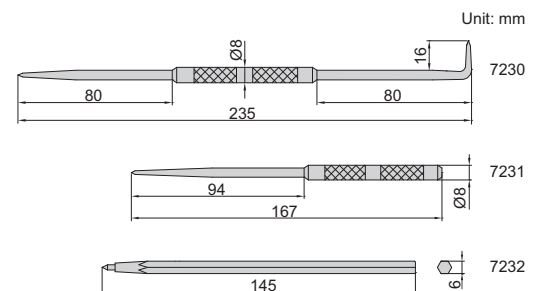


7231



7232

Code	Tip
7230	hardened tips
7231	hardened tip
7232	carbide tip



2-PIECE MEASURING TOOL SETS

■ Includes:

- 1) Vernier caliper, range 0-150mm/0-6", graduation 0.05mm/1/128" (code **1205-150S**) for **5021**, graduation 0.02mm/0.001" (code **1205-1502S**) for **5021-2**
- 2) Outside micrometer, range 0-25mm, graduation 0.01mm (code **3202-25A**)

Code	Remark
5021	Vernier caliper, graduation 0.05mm/1/128" (code 1205-150S)
5021-2	Vernier caliper, graduation 0.02mm/0.001" (code 1205-1502S)



5021

11

2-PIECE MEASURING TOOL SET

■ Includes:

- 1) Digital caliper, range 0-150mm/0-6", resolution 0.01mm/0.0005"
- 2) Digital outside micrometer, range 0-25mm/0-1", resolution 0.001mm/0.00005" (code **3109-25A**)

Code	Remark
5022	Digital caliper, with thumb roller, code 1108-150
5022-W	Digital caliper, without thumb roller, code 1108-150W



5022

2-PIECE MEASURING TOOL SET

■ Includes:

- 1) Dial test indicator, range 0.8mm, graduation 0.01mm (code **2380-08**)
- 2) Magnetic stand

Code
5023



5023

2-PIECE MEASURING TOOL SET

- Includes:
 - 1) Dial indicator, range 10mm, graduation 0.01mm (code **2308-10A**)
 - 2) Magnetic stand (code **6201-60**)

Code
5024



5024

3-PIECE MEASURING TOOL SET

- Includes:
 - 1) Digital indicator, range 12.7mm/0.5", resolution 0.01mm/0.0005" (code **2112-10**)
 - 2) Flex arm
 - 3) Locking pliers, adjustable jaw opening from 0 to 25mm



Code
5031



5031

3-PIECE MEASURING TOOL SET

- Includes:
 - 1) Vernier caliper, range 0-150mm graduation 0.02mm (code **1205-1501S**)
 - 2) Outside micrometer, range 0-25mm, graduation 0.01mm (code **3203-25A**)
 - 3) Steel rule, range 150mm/6", graduation 0.5mm, 1mm, 1/64", 1/32", 1/16" (code **7110-150**)
 - 4) Dust free gloves and dust free cloth

dust free gloves and dust free cloth



Code
5032



5032

4-PIECE MEASURING TOOL SETS

■ Includes:

- 1) Vernier caliper, range 0-150mm/0-6", graduation 0.05mm/1/128" (code **1205-150S**) for **5041**, graduation 0.02mm/0.001" (code **1205-1502S**) for **5041-2**
- 2) Outside micrometer, range 0-25mm, graduation 0.01mm (code **3202-25A**)
- 3) 90° beveled edge square, 100x70mm, grade 0 (code **4790-1000**)
- 4) Steel rule, 150mm/6" (code **7110-150**)

Code	Remark
5041	Vernier caliper, graduation 0.05mm/1/128" (code 1205-150S)
5041-2	Vernier caliper, graduation 0.02mm/0.001" (code 1205-1502S)



5041

4-PIECE MEASURING TOOL SET

■ Includes:

- 1) Digital caliper, range 0-150mm/0-6", resolution 0.01mm/0.0005"
- 2) Outside micrometer, range 0-25mm, graduation 0.01mm, (code **3202-25A**)
- 3) 90° beveled edge square, 100x70mm, grade 0 (code **4790-1000**)
- 4) Steel rule, 150mm/6" (code **7110-150**)

Code	Remark
5042	Digital caliper, with thumb roller, code 1108-150
5042-W	Digital caliper, without thumb roller, code 1108-150W



5042

5-PIECE MEASURING TOOL SET

■ Includes:

- 1) Digital caliper, range 0-150mm/0-6", resolution 0.01mm/0.0005"
- 2) Outside micrometer, range 0-25mm, graduation 0.01mm (code **3203-25A**)
- 3) Dial indicator, range 10mm, graduation 0.01mm (code **2308-10A**)
- 4) Magnetic stand (code **6201-60**)
- 5) Micrometer stand (code **6300**)

Code	Remark
5051	Digital caliper, with thumb roller, code 1108-150
5051-W	Digital caliper, without thumb roller, code 1108-150W



5051

5-PIECE MEASURING TOOL SET

Includes:

- 1) Digital caliper, range 0-150mm/0-6", resolution 0.01mm/0.0005"
- 2) Digital outside micrometer, range 0-25mm/0-1", resolution 0.001mm/0.00005" (code **3109-25A**)
- 3) Digital indicator, range 12.7mm/0.5", resolution 0.01mm/0.0005" (code **2112-10**)
- 4) Magnetic stand (code **6201-60**)
- 5) Micrometer stand (code **6300**)

Code	Remark
5052	Digital caliper, with thumb roller, code 1108-150
5052-W	Digital caliper, without thumb roller, code 1108-150W



5052

6-PIECE MEASURING TOOL SET

Includes:

- 1) Digital caliper, range 0-150mm/0-6", resolution 0.01mm/0.0005"
- 2) Outside micrometer, range 0-25mm, graduation 0.01mm (code **3202-25A**)
- 3) Dial indicator, range 10mm, graduation 0.01mm (code **2308-10FA**)
- 4) 90° beveled edge square, 100x70mm, grade 0 (code **4790-1000**)
- 5) Scriber (code **7230**)
- 6) Steel rule, 150mm/6" (code **7110-150**)

Code	Remark
5061	Digital caliper, with thumb roller, code 1108-150
5061-W	Digital caliper, without thumb roller, code 1108-150W



5061

6-PIECE MEASURING TOOL SET

Includes:

- 1) Digital caliper, range 0-150mm/0-6" resolution 0.01mm/0.0005"
- 2) Outside micrometer, range 0-25mm graduation 0.01mm (code **3202-25A**)
- 3) 90° beveled edge square, 100x70mm grade 00 (code **4790-0100**)
- 4) Straight edge, 100mm (code **4700-100**)
- 5) Spring divider, 150mm (code **7260-150**)
- 6) Steel rule, 200mm/8" (code **7110-200**)

Code	Remark
5062	Digital caliper, with thumb roller, code 1108-150
5062-W	Digital caliper, without thumb roller, code 1108-150W



5062

6-PIECE MEASURING TOOL SETS

Includes:

- 1) Vernier caliper, range 0-150mm/0-6", graduation 0.05mm/1/128" (code **1205-150S**) for **5063**, graduation 0.02mm/0.001" (code **1205-1502S**) for **5063-2**
- 2) Outside micrometer, range 0-25mm graduation 0.01mm (code **3202-25A**)
- 3) 90° beveled edge square, 100x70mm grade 00 (code **4790-0100**)
- 4) Straight edge, 100mm (code **4700-100**)
- 5) Spring divider, 150mm (code **7260-150**)
- 6) Steel rule, 200mm/8" (code **7110-200**)

Code	Remark
5063	Vernier caliper, graduation 0.05mm/1/128" (code 1205-150S)
5063-2	Vernier caliper, graduation 0.02mm/0.001" (code 1205-1502S)



5063

9-PIECE MEASURING TOOL SET

Includes:

- 1) Digital caliper, range 0-150mm/0-6", resolution 0.01mm/0.0005"
- 2) Outside micrometer, range 0-25mm, graduation 0.01mm (code **3202-25A**)
- 3) Protractor, range 0-180°, graduation 1° (code **4799-180**)
- 4) Pitch gauge, range 0.25-7mm, 24pcs, metric 60° thread (code **4820-124**)
- 5) Radius gauge, range 1-7mm (code **4801-17**)
- 6) Feeler gauge, range 0.05-1.00mm, 20pcs (code **4602-20**)
- 7) 90° beveled edge square, 100x70mm, grade 0 (code **4790-1000**)
- 8) Scriber (code **7230**)
- 9) Steel rule, 150mm/6" (code **7110-150**)

Code	Remark
5091	Digital caliper, with thumb roller, code 1108-150
5091-W	Digital caliper, without thumb roller, code 1108-150W



5091

13-PIECE MEASURING TOOL SET

Includes:

- 1) Digital caliper, range 0-150mm/0-6", resolution 0.01mm/0.0005"
- 2) Outside micrometer, range 0-25mm, graduation 0.01mm (code **3202-25A**)
- 3) Dial indicator, range 10mm, graduation 0.01mm (code **2308-10A**)
- 4) Magnetic stand (code **6201-60**)
- 5) Protractor, range 0-180°, graduation 1° (code **4799-180**)
- 6) Pitch gauge, range 0.25-7mm, 24pcs, metric 60° thread (code **4820-124**)
- 7) Radius gauge, range 1-7mm (code **4801-17**)
- 8) Feeler gauge, range 0.05-1.00mm, 20pcs (code **4602-20**)
- 9) 90° beveled edge square, 100x70mm, grade 0 (code **4790-1000**)
- 10) Scriber (code **7230**)
- 11) Steel rule, 150mm/6" (code **7110-150**)
- 12) Depth base attachment (code **6140**)
- 13) Zero setting bar for depth base attachment

Code	Remark
5013	Digital caliper, with thumb roller, code 1108-150
5013-W	Digital caliper, without thumb roller, code 1108-150W



5013

CUSTOM-MADE
SUPPLY SPECIAL SIZES ACCORDING
TO CUSTOMER'S REQUEST

GRANITE SURFACE PLATES

**INSPECTION
CERTIFICATE**



6900-132

Grade 00

Code	Size (LxWxH)	Flatness	Weight	Max. load
6900-132*	300x200x60mm	2.7µm	11kg	30kg
6900-142*	400x250x60mm	2.9µm	18kg	50kg
6900-144*	400x400x60mm	3.1µm	29kg	60kg
6900-153*	500x315x70mm	3.2µm	33kg	60kg
6900-164*	630x400x80mm	3.5µm	60kg	65kg
6900-166*	630x630x100mm	3.8µm	119kg	75kg
6900-185*	800x500x100mm	3.9µm	120kg	100kg
6900-1106*	1000x630x140mm	4.4µm	265kg	200kg
6900-1101*	1000x1000x150mm	4.8µm	450kg	400kg
6900-1128*	1200x800x160mm	4.9µm	461kg	500kg
6900-1161*	1600x1000x180mm	5.8µm	864kg	600kg
6900-1201*	2000x1000x220mm	6.5µm	1320kg	650kg
6900-1202*	2000x1500x250mm	7.0µm	2250kg	750kg



- Made of granite, free from deterioration or dimensional change over time, minimal changes in dimension due to temperature changes
- Meet DIN876, grade 00 is for inspection room or lab, grade 0 is for workshop
- Optional accessory:
stand for granite surface plate (code 6902),
jack for granite surface plate (code 6903)

Grade 0

Code	Size (LxWxH)	Flatness	Weight	Max. load
6900-032*	300x200x60mm	5.4µm	11kg	60kg
6900-042*	400x250x60mm	5.9µm	18kg	100kg
6900-044*	400x400x60mm	6.3µm	29kg	120kg
6900-053*	500x315x70mm	6.4µm	33kg	120kg
6900-064*	630x400x80mm	7.0µm	60kg	130kg
6900-066*	630x630x100mm	7.6µm	119kg	150kg
6900-085*	800x500x100mm	7.8µm	120kg	200kg
6900-0106*	1000x630x140mm	8.7µm	265kg	400kg
6900-0101*	1000x1000x150mm	9.7µm	450kg	800kg
6900-0128*	1200x800x160mm	9.8µm	461kg	1000kg
6900-0161*	1600x1000x180mm	11.5µm	864kg	1200kg
6900-0201*	2000x1000x220mm	12.9µm	1320kg	1300kg
6900-0202*	2000x1500x250mm	14.0µm	2250kg	1500kg

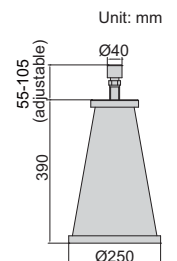
*Supplied with manufacturer inspection certificate

JACK SET FOR GRANITE SURFACE PLATES

- 5 jacks per set
- Adjustable height
- For large granite surface plates:
2000x1000x220mm
(code 6900-0201 and 6900-1201)
2000x1500x250mm
(code 6900-0202 and 6900-1202)



6903-B

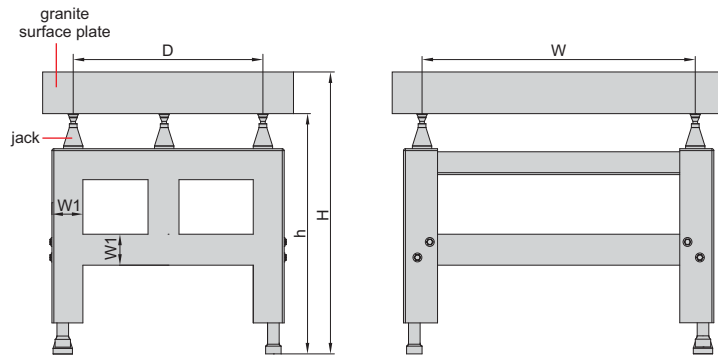


Code
6903-B

STANDS FOR GRANITE SURFACE PLATES



6902-64A



12

- For medium size granite surface plates
- 5 jacks are included
- Adjusting range of jacks: 25mm
- One foot on the bottom is adjustable

Low stands

Code	For granite surface plate	W	D	H (with granite surface plate)	h (without granite surface plate)	W1
6902-64A	630x400x80mm (code 6900-064 and 6900-164)	352	224	775-800	695-720	80
6902-66A	630x630x100mm (code 6900-066 and 6900-166)	352	352	775-800	675-700	80
6902-85A	800x500x100mm (code 6900-085 and 6900-185)	448	280	775-800	675-700	80
6902-106A	1000x630x140mm (code 6900-0106 and 6900-1106)	560	352	755-780	615-640	80
6902-101A	1000x1000x150mm (code 6900-0101 and 6900-1101)	560	560	755-780	605-630	80
6902-128A	1200x800x160mm (code 6900-0128 and 6900-1128)	672	448	755-780	595-620	80
6902-161A	1600x1000x180mm (code 6900-0161 and 6900-1161)	896	560	755-780	575-600	80
6902-201A	2000x1000x220mm (code 6900-0201 and 6900-1201)	1120	560	755-780	535-560	100
6902-202A	2000x1500x250mm (code 6900-0202 and 6900-1202)	1120	840	755-780	505-530	100

High stands

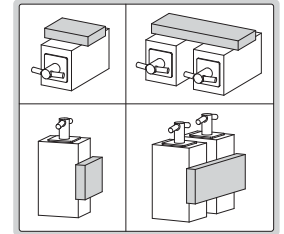
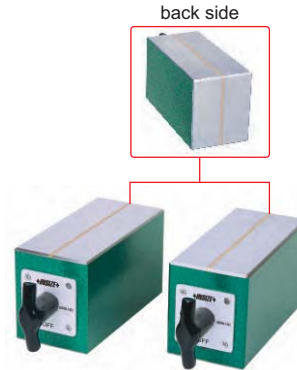
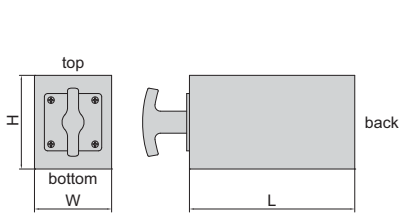
Code	For granite surface plate	W	D	H (with granite surface plate)	h (without granite surface plate)	W1
6902-64H	630x400x80mm (code 6900-064 and 6900-164)	352	224	1000-1025	920-945	80
6902-66H	630x630x100mm (code 6900-066 and 6900-166)	352	352	1000-1025	900-925	80
6902-85H	800x500x100mm (code 6900-085 and 6900-185)	448	280	1000-1025	900-925	80
6902-106H	1000x630x140mm (code 6900-0106 and 6900-1106)	560	352	1000-1025	860-885	80
6902-101H	1000x1000x150mm (code 6900-0101 and 6900-1101)	560	560	1000-1025	850-875	80
6902-128H	1200x800x160mm (code 6900-0128 and 6900-1128)	672	448	1000-1025	840-865	80
6902-161H	1600x1000x180mm (code 6900-0161 and 6900-1161)	896	560	1000-1025	820-845	80
6902-201H	2000x1000x220mm (code 6900-0201 and 6900-1201)	1120	560	1000-1025	780-805	100
6902-202H	2000x1500x250mm (code 6900-0202 and 6900-1202)	1120	840	1000-1025	750-775	100

HARDENED SURFACES

HIGH PRECISION

STRONG MAGNETIC FORCE

MAGNETIC RECTANGULAR BLOCKS



- For grinding, light milling, drilling and inspection of round and square jobs
- Hardened, high accuracy, strong magnetic force
- Working surfaces are hardened to HRC58-62
- Magnetic force on top, bottom and back sides
- Supplied in matched pair

6898-150

Code	Size (LxWxH)	Magnetic force	Parallelism of top to bottom side	Squareness of top and bottom to back side	Height difference of a matched pair
6898-100	100x70x70mm	100kgf	5µm	5µm	5µm
6898-150	150x70x85mm	125kgf	5µm	5µm	5µm

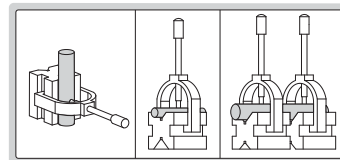
V-BLOCK SETS



6896-10

6896-11

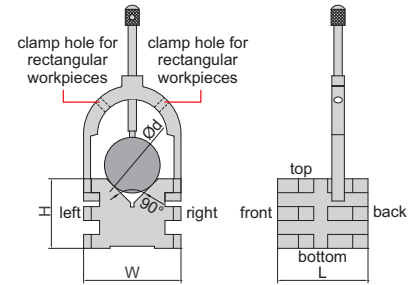
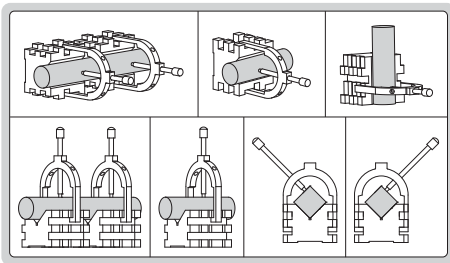
- Hold cylindrical workpieces for inspection and machining
- Two V-blocks per set
- Made of alloy steel
- Hardened to HRC60±2
- V groove on the top for large shafts
- V groove on the bottom for small shafts (except 6896-10)



Code	Size (LxWxH)	Range of shafts (Ød)	Parallelism of both V grooves to top and bottom sides	Squareness of both V grooves to front and back sides	Height difference of a matched pair
6896-10	25x20x20mm	3-20mm	3µm	3µm	3µm
6896-11	50x40x40mm	5-30mm	5µm	5µm	5µm
6896-12	80x63x63mm	7-63mm	5µm	5µm	5µm
6896-13	100x80x80mm	7-80mm	5µm	5µm	5µm
6896-14	70x140x140mm	9-140mm	5µm	5µm	5µm

V-BLOCK SET

SIDE LIE-DOWN USE IS POSSIBLE



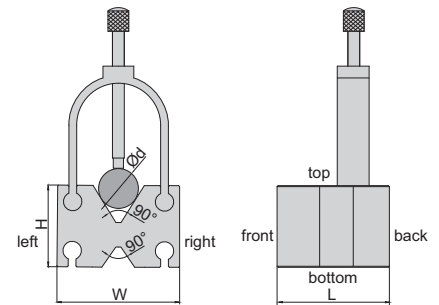
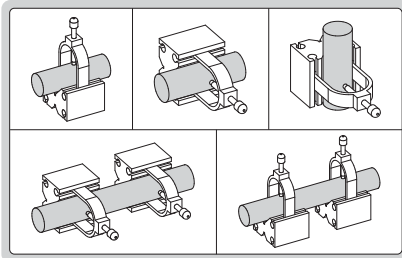
6802-1

- Hold cylindrical or rectangular workpieces for inspection and machining
- Two V-blocks per set
- Made of alloy steel
- Hardened to HRC60±2
- Applicable for cylinder with diameter (Ød): 5-50mm
- Applicable for rectangular workpieces with thickness: ≤35mm

Code	Size (LxWxH)	Parallelism of V groove to top, bottom, left, right sides	Squareness of V groove to front and back sides	Height difference of a matched pair
6802-1	65x70x50mm	5µm	5µm	5µm

V-BLOCK SETS

SIDE LIE-DOWN USE IS POSSIBLE



6803-1

- Hold cylindrical workpieces for inspection and machining
- Two V-blocks per set
- Made of alloy steel
- Hardened to HRC60±2
- V groove on the top for large shafts
- V groove on the bottom for small shafts

Code	Size (LxWxH)	Range of shafts (Ød)	Parallelism of both V grooves to top, bottom, left, right sides	Squareness of both V grooves to front and back sides	Height difference of a matched pair
6803-1	55x60x40mm	4-35mm	5µm	5µm	5µm
6803-2	65x70x45mm	4-47mm	5µm	5µm	5µm

V-BLOCK

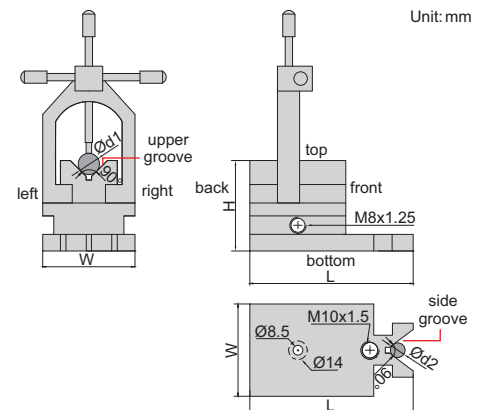
the adjustable screw can support the block and prevent tilting



side groove is for shouldered studs and pins



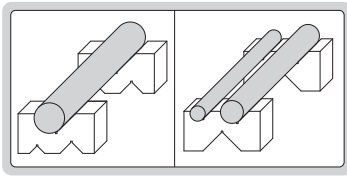
6804-M2



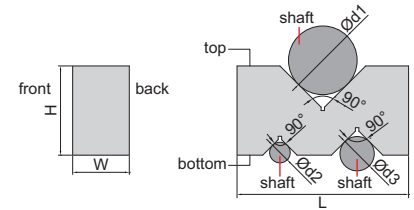
- Hold cylindrical workpieces for inspection and machining
- Made of alloy steel
- Hardened to HRC60±2

Code	Size (LxWxH)	Range of shafts (Ød1 and Ød2)	Parallelism of upper groove to bottom, left and right sides	Squareness of upper groove to back side	Parallelism of side groove to back side
6804-M2	90x48x48mm	5-33mm	5µm	5µm	5µm

V-BLOCK SETS



6887-3

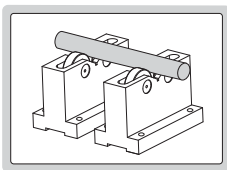


- Two V-blocks per set
- Made of hardened tool steel

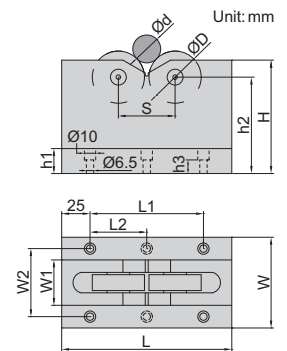
Code	Size (LxWxH)	Range of shafts (Ød1)	Range of shafts (Ød2)	Range of shafts (Ød3)
6887-1	50x19x24mm	3-32mm	3-16mm	3-22mm
6887-2	75x24x35mm	3-50mm	3-20mm	3-32mm
6887-3	100x33x52mm	3-68mm	3-26mm	3-40mm
6887-4	125x44x69mm	3-87mm	3-34mm	3-50mm

Code	Parallelism of three V grooves to top and bottom sides	Height difference of a matched pair
6887-1	5µm	5µm
6887-2	5µm	5µm
6887-3	5µm	5µm
6887-4	5µm	5µm

ROLLER BEARING V-BLOCK SETS



6888-1

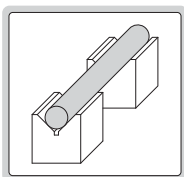


- Runout accuracy: 5µm
- Parallelism of bearings to bottom: 12µm
- Two V-blocks per set
- Workpieces don't get damaged due to bearings
- Suitable for heavy workpieces

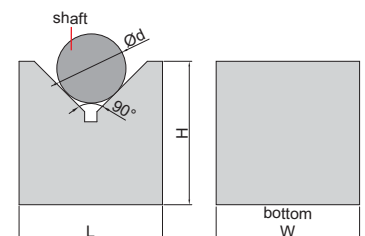
Code	Size (LxWxH)	Code of bearings	Diameter of bearings (ØD)	Range of shafts (Ød)	Load capacity
6888-1	150x60x100mm	16004 ZZ	42mm	25-70mm	500kg
6888-2	150x80x100mm	6303 ZZ	47mm	5-55mm	1000kg
6888-3	230x100x150mm	6306 ZZ	72mm	70-200mm	1000kg

Code	W1	W2	h1	h2	h3	L1	L2	S
6888-1	22	44	20	85	12	100	-	60
6888-2	40	60	22	85	12	100	-	50
6888-3	60	80	30	124	20	180	90	120

GRANITE V-BLOCK SETS



6897-1



- Two V-blocks per set

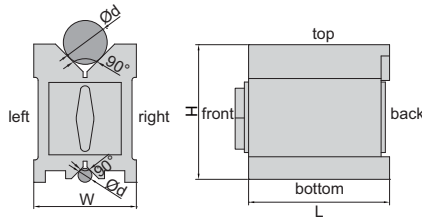
Code	Size (LxWxH)	Range of shafts (Ød)	Parallelism of V groove to bottom	Height difference of a matchet pair
6897-1	70x50x70mm	6-75mm	4µm	5µm
6897-2	100x50x70mm	6-99mm	4µm	5µm

MAGNETIC V-BLOCKS (ADVANCED TYPE)

HARDENED SURFACES

HIGH PRECISION

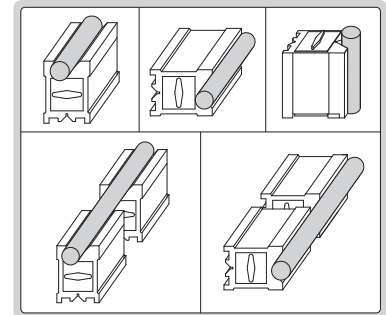
STRONG MAGNETIC FORCE



6889-11



6889-1



- Hardened, high accuracy, strong magnetic force, for grinding, light milling, drilling and inspection of round and square workpieces
- All working surfaces are hardened to HRC60±2
- Magnetic force on top, bottom and two V grooves
- V groove on the top for large shafts
- V groove on the bottom for small shafts
- Suitable for cast iron surface plates and granite surface plates

Individual

Code	Size (LxWxH)	Range of shafts (Ød)	Magnetic force	Parallelism of V grooves to top, bottom, left, right sides	Squareness of V grooves to back side
6889-11	75x56x75mm	5-40mm	85kgf	5µm	5µm
6889-22	100x70x95mm	5-65mm	150kgf	5µm	5µm
6889-33	150x75x100mm	5-70mm	190kgf	6µm	6µm
6889-55	160x125x130mm	5-140mm	220kgf	12µm	12µm
6889-44	200x125x150mm	10-140mm	400kgf	12µm	12µm

Matched pair

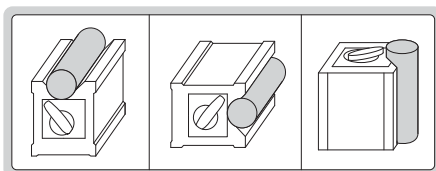
Code	Size (LxWxH)	Range of shafts (Ød)	Magnetic force	Parallelism of V grooves to top, bottom, left, right sides	Squareness of V grooves to back side	Height difference of a matched pair
6889-1	75x56x75mm	5-40mm	85kgf	5µm	5µm	5µm
6889-2	100x70x95mm	5-65mm	150kgf	5µm	5µm	5µm
6889-3	150x75x100mm	5-70mm	190kgf	6µm	6µm	6µm
6889-5	160x125x130mm	5-140mm	220kgf	12µm	12µm	12µm
6889-4	200x125x150mm	10-140mm	400kgf	12µm	12µm	12µm

MAGNETIC V-BLOCK (ECONOMIC TYPE)

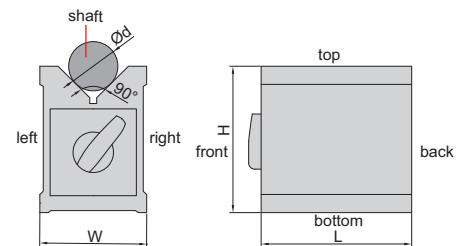
ATTENTION: NOT SUITABLE FOR STEEL OR IRON SURFACES, OTHERWISE THE MAGNETIC FORCE WILL BE REDUCED

ATTENTION: NOT HARDENED

- Hold cylindrical workpieces for inspection and machining
- Supplied in single piece
- Not hardened
- Not suitable for steel or iron surfaces, otherwise the magnetic force will be reduced



6890-702



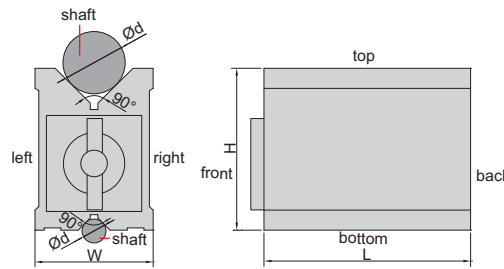
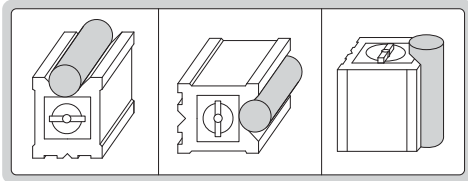
Code	Size (LxWxH)	Range of shafts (Ød)	Magnetic force	Parallelism of V groove to top, bottom, left and right sides	Squareness of V groove to back side
6890-702	70x60x73mm	6-44mm	56kgf	10µm	10µm

ATTENTION: NOT SUITABLE FOR STEEL OR IRON SURFACES, OTHERWISE THE MAGNETIC FORCE WILL BE REDUCED

ATTENTION: NOT HARDENED

MAGNETIC V-BLOCKS (ECONOMIC TYPE)

- Hold cylindrical workpieces for inspection and machining
- Supplied in single piece
- Not hardened
- V groove on the top for large shafts
- V groove on the bottom for small shafts
- Not suitable for steel or iron surfaces, otherwise the magnetic force will be reduced



6801-1201

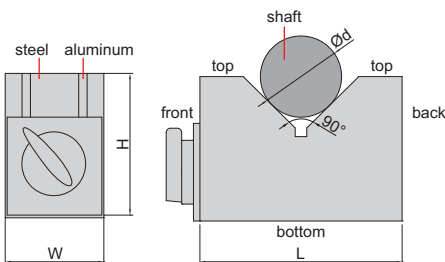
Code	Size (LxWxH)	Range of shafts (Ød)	Magnetic force	Parallelism of V grooves to top, bottom, left, right side	Squareness of V grooves to back side
6801-1201	80x70x95mm	6-67mm	64kgf	10µm	10µm
6801-1202	100x70x95mm	6-67mm	80kgf	10µm	10µm
6801-1203	120x70x95mm	6-67mm	96kgf	10µm	10µm

MAGNETIC V-BLOCK SETS

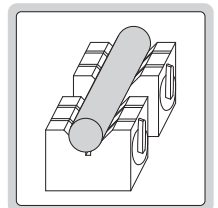
12

ATTENTION: NOT HARDENED, DO NOT ROTATE WORKPIECES ON V-BLOCKS

ATTENTION: LOW MAGNETIC FORCE



6891-1



- Hold cylindrical workpieces for inspection, not suitable for machining due to low magnetic force
- Two V-blocks per set
- Hardness HRB70

Code	Size (LxWxH)	Range of shafts (Ød)	Magnetic force	Parallelism of V groove to bottom and back sides	Height difference of a matched pair
6891-1	70x40x50mm	6-46mm	8kgf	10µm	10µm
6891-3	150x50x100mm	6-125mm	14kgf	10µm	10µm

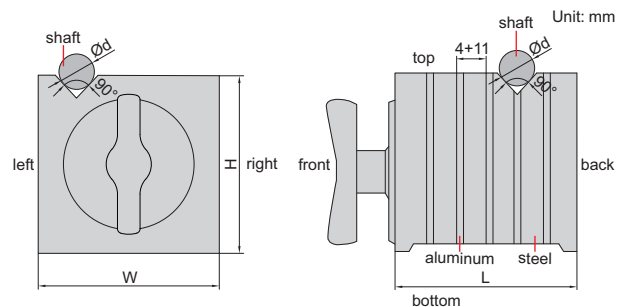
ATTENTION: NOT HARDENED, DO NOT ROTATE WORKPIECES ON V-BLOCKS

MAGNETIC SQUARE WITH V GROOVE

- Hold flat and cylindrical workpieces for inspection and machining
- Magnetic force on top, left, right and V grooves
- Parallelism and squareness of top, bottom, left, right and back: 20µm
- Parallelism and squareness of V grooves to top, bottom, left, right and back: 20µm



6539-100



Code	Size (LxWxH)	Magnetic force of V grooves		Magnetic force of top, left and right sides		Range of shafts (Ød)
		On granite surface plate	On cast iron plate	On granite surface plate	On cast iron plate	
6539-100	100x100x100mm	30kgf	25kgf	50kgf	30kgf	5-35mm

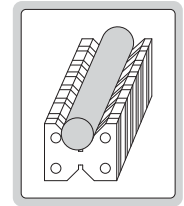
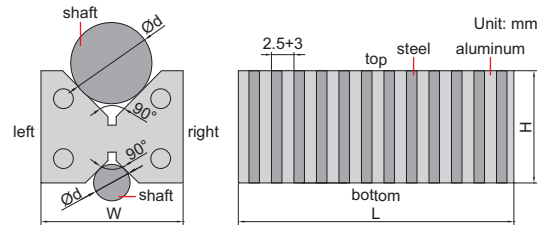
MAGNETIC INDUCTION V-BLOCK

ATTENTION: NOT HARDENED, DO NOT ROTATE WORKPIECES ON V-BLOCKS

- Hold cylindrical workpieces for inspection and machining
- To be used on magnetic chucks
- Supplied in single piece
- V groove on the top for large shafts
- V groove on the bottom for small shafts
- Hardness HRB70



6892-1

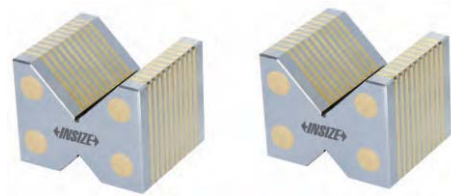


Code	Size (LxWxH)	Range of shafts ($\varnothing d$)	Pole pitch	Parallelism of both V grooves to top and bottom sides
6892-1	110x60x48mm	6-50mm	2.5+3mm	10 μ m

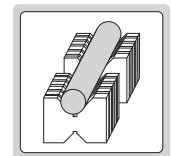
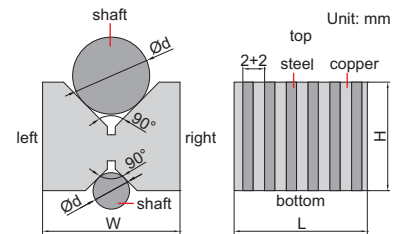
MAGNETIC INDUCTION V-BLOCK SET

ATTENTION: NOT HARDENED, DO NOT ROTATE WORKPIECES ON V-BLOCKS

- Hold cylindrical workpieces for inspection and machining
- To be used on magnetic chucks
- Two V-blocks per set
- V groove on the top for large shafts
- V groove on the bottom for small shafts
- Hardness HRB70
- Copper magnetic strips



6878-1



Code	Size (LxWxH)	Range of shafts ($\varnothing d$)	Pole pitch	Parallelism of both V grooves to top and bottom sides	Height difference of a matched pair
6878-1	49x58x46mm	5-56mm	2+2mm	10 μ m	10 μ m

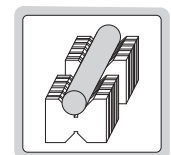
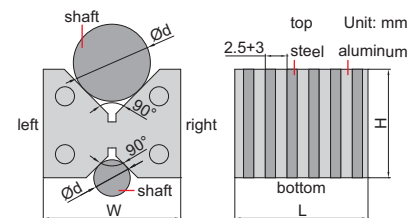
MAGNETIC INDUCTION V-BLOCK SET (ECONOMIC TYPE)

ATTENTION: NOT HARDENED, DO NOT ROTATE WORKPIECES ON V-BLOCKS

- Hold cylindrical workpieces for inspection and machining
- To be used on magnetic chucks
- Two V-blocks per set
- V groove on the top for large shafts
- V groove on the bottom for small shafts
- Hardness HRB70



6899-1



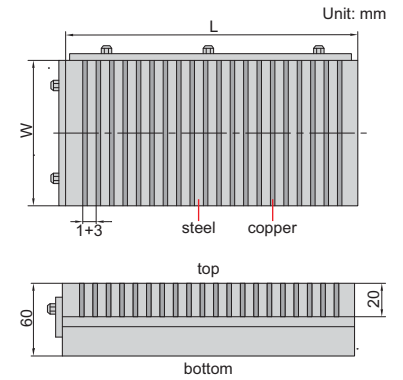
Code	Size (LxWxH)	Range of shafts ($\varnothing d$)	Pole pitch	Parallelism of both V grooves to top and bottom sides	Height difference of a matched pair
6899-1	55x60x48mm	6-50mm	2.5+3mm	10 μ m	10 μ m

**ATTENTION:
NOT HARDENED**

PERMANENT MAGNETIC CHUCK



6537-400



Code	Table size (L×W)	Magnetic force	Pole pitch	Parallelism of top to bottom
6537-400	400×200mm	16kgf/cm ²	1+3mm	0.005mm/100mm

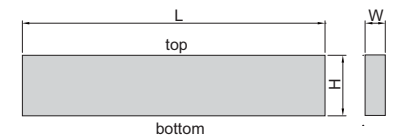
PARALLEL SETS

12



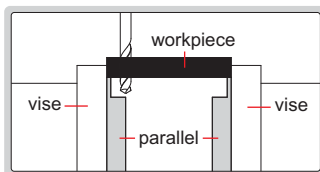
6533-144

- Parallelism between top and bottom: 5µm
- Height difference of a matched pair: 5µm
- Made of alloy tool steel
- Hardened to HRC55-60



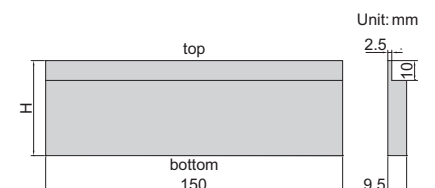
Code	Parallels per set	Length (L)	Thickness (W)	Height (H)
6533-10	10 pairs	150mm	3mm	13, 16, 19, 22, 25, 28, 31, 35, 38, 41mm
6533-144	14 pairs	150mm	10mm	14, 16, 18, 20, 22, 24, 26, 28, 30, 32, 35, 40, 45, 50mm
6533-6	6 pairs	200mm	9.5mm	35, 40, 45, 50, 55, 58mm

PARALLEL SET



6534-6

- Parallelism between top and bottom: 5µm
- Height difference of a matched pair: 5µm
- Made of alloy tool steel
- Hardened to HRC55-60



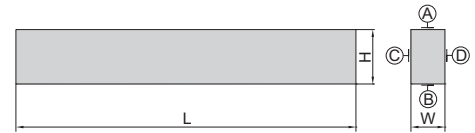
Code	Parallels per set	Height (H)
6534-6	6 pairs	25, 30, 35, 40, 45, 48mm

GRANITE PARALLEL SET

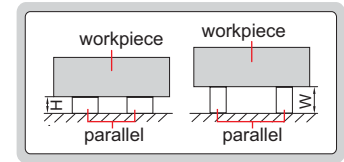
- Made of granite, hard and no rusty, no dimensional change over time or temperature change
- Two parallels per set



4143-250



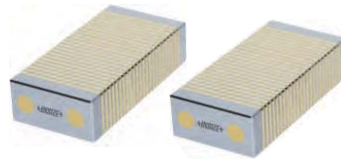
Code	Size (LxWxH)	Parallelism between A and B	Parallelism between C and D	Height difference of a matched pair
4143-250	250x25x40mm	3µm	3µm	3µm



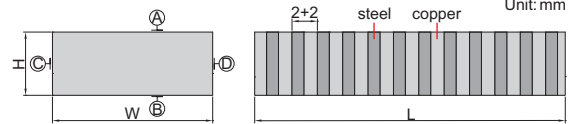
MAGNETIC INDUCTION PARALLEL SET

ATTENTION:
NOT HARDENED

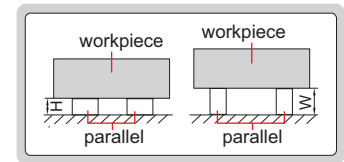
- To be used on magnetic chucks
- Two parallels per set
- Hardness HRB70
- Copper magnetic strips



6879-1

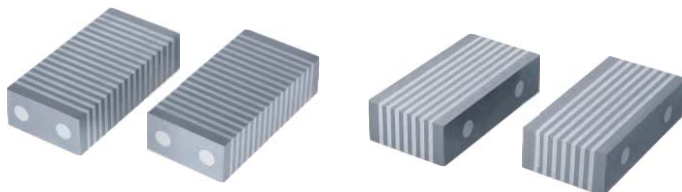


Code	Size (LxWxH)	Pole pitch	Parallelism between A and B	Parallelism between C and D	Height difference of a matched pair
6879-1	100x50x25mm	2+2mm	10µm	10µm	10µm



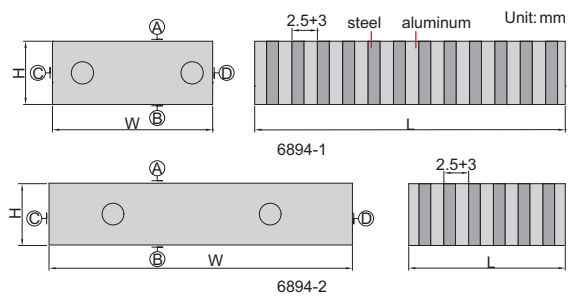
MAGNETIC INDUCTION PARALLEL SETS (ECONOMIC TYPE)

ATTENTION:
NOT HARDENED



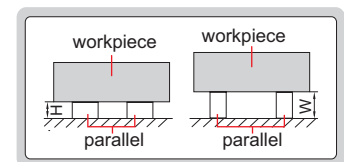
6894-1

6894-2



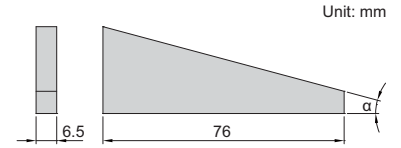
- To be used on magnetic chucks
- Two parallels per set
- Hardness HRB70

Code	Size (LxWxH)	Pole pitch	Parallelism between A and B	Parallelism between C and D	Height difference of a matched pair
6894-1	100x50x25mm	2.5+3mm	10µm	10µm	10µm
6894-2	50x100x25mm	2.5+3mm	10µm	10µm	10µm



ANGLE PLATE SETS

- For angle set-up in tooling, production and inspection
- Made of tool steel
- Hardness HRC55

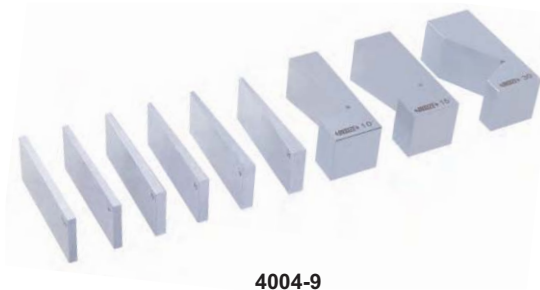


4003-12

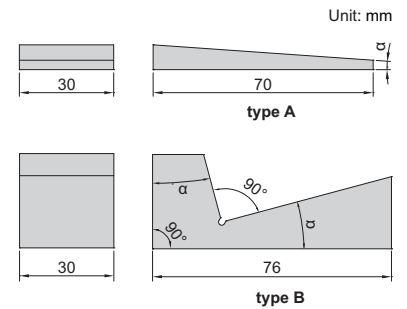
Code	Angle plates included	Angle α	Accuracy
4003-10	10 pcs	1°, 2°, 3°, 4°, 5°, 10°, 15°, 20°, 25°, 30°	±9 seconds
4003-12	12 pcs	1/4°, 1/2°, 1°, 2°, 3°, 4°, 5°, 10°, 15°, 20°, 25°, 30°	±9 seconds

ANGLE PLATE SET

- For angle set-up in tooling, production and inspection
- Made of tool steel
- Hardness HRC55



4004-9



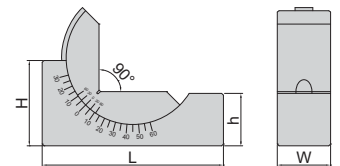
Code	Angle plates included	Angle α	Type	Accuracy
4004-9	9 pcs	1/2°, 1°, 2°, 3°, 4°, 5°	type A	±30 seconds
		10°, 15°, 30°	type B	±50 seconds

ADJUSTABLE ANGLE BLOCKS

- Made of hardened tool steel
- With locking screw
- Accuracy of angle: 10 minutes

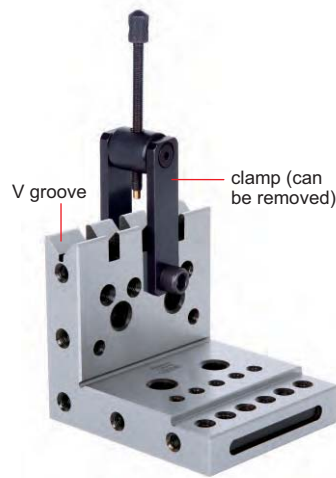


6535-30



Code	Size (LxWxH)	h	Adjustable angle	Graduation of angle
6535-25	75x25x36mm	25mm	30°~0°~60°	10 minutes
6535-30	102x30x49mm	30mm	30°~0°~60°	10 minutes

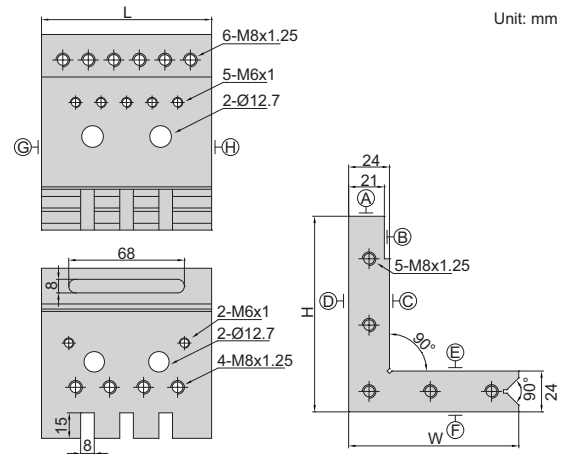
RIGHT ANGLE PLATE



6547-1

- Made of alloy steel
- Hardened to HRC60±2
- V groove for cylinders
- Parallelism and squareness between A, B, C, D, E, F, G and H: 6µm
- Parallelism and squareness of V groove to A, B, C, D, E, F, G and H: 6µm

Code	Size (LxWxH)
6547-1	100x100x115mm



12

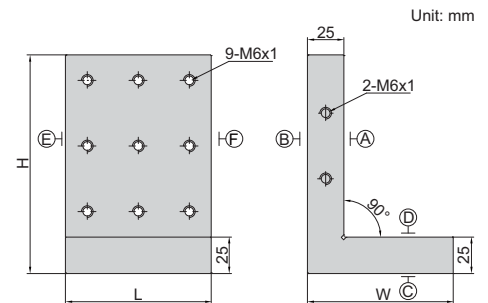
RIGHT ANGLE PLATE



6548-1

- Made of tool steel
- Hardened to HRC60±2
- Squareness or parallelism between A, B, C, D, E and F: 5µm

Code	Size (LxWxH)
6548-1	100x100x150mm



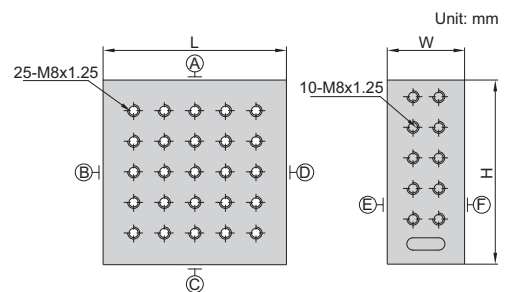
RIGHT ANGLE PLATE



6549-1

- Made of tool steel
- Hardened to HRC56-58
- Parallelism between A, B, C, D, E and F: 3µm
- Squareness between A, B, C, D, E and F: 5µm

Code	Size (LxWxH)
6549-1	150x63x150mm

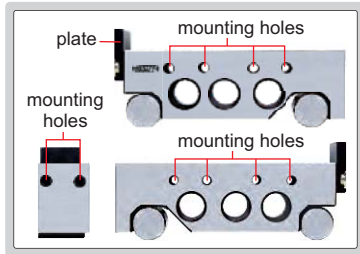


SINE BARS

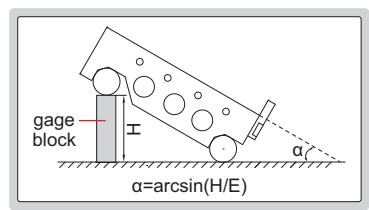
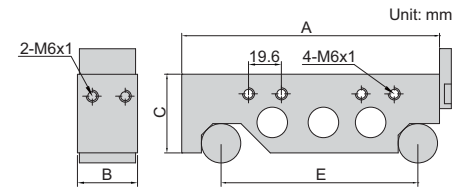
CAN BE CUSTOMIZED

HIGH PRECISION

The front and back ends and two sides have mounting holes to install plate



4155-100



- Made of alloy tool steel

Code	Roller distance (E)	Table size (AxB)	C	Accuracy of α at 30°
4155-100	100mm	130x30mm	40mm	±5 seconds
4155-200	200mm	230x30mm	40mm	±5 seconds
4155-300	300mm	345x40mm	50mm	±8 seconds

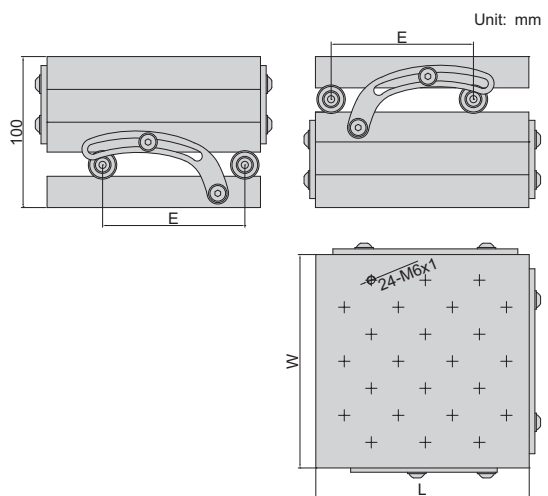
COMPOUND SINE TABLE



6536-100

- Accuracy of angle: ±15 seconds
- Made of alloy tool steel
- Hardness HRC58-60

Code	Roller distance (E)	Table size (LxW)	Adjustable angle
6536-100	100mm	150x150mm	0-60°



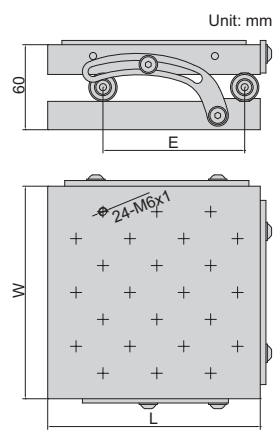
SINE TABLE



6527-100

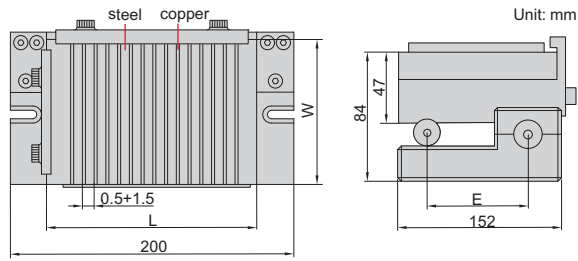
- Accuracy of angle: ±15 seconds
- Made of alloy tool steel
- Hardness HRC58-60

Code	Roller distance (E)	Table size (LxW)	Adjustable angle
6527-100	100mm	150x150mm	0-60°



MAGNETIC SINE TABLE

**ATTENTION:
NOT HARDENED**



6538-100

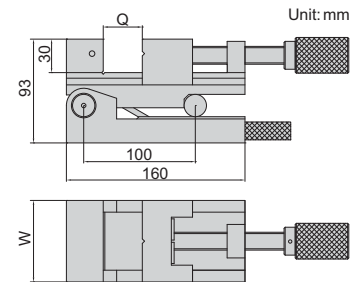
Code	Table size (L×W)	Roller distance (E)	Adjustable angle	Accuracy of angle
6538-100	150×150mm	100mm	0-60°	±15 seconds

PRECISION SINE VISE



6522-80

There is a 1mm step (accuracy +/-0.002mm). Gage blocks smaller than 0.5mm are not available. If small gage blocks are needed (for example, 0.25mm), a gage block 1.25mm can be used in order to make 1.25mm - 1mm = 0.25mm.

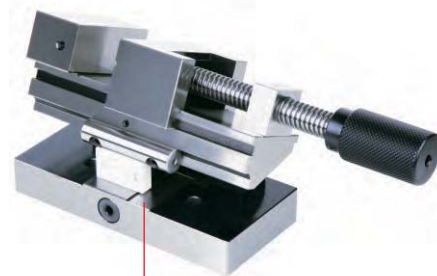


- Parallelism: 3μm/100mm
- Squareness: 5μm/100mm
- Accuracy of angle: ±15 seconds
- Made of SKS tool steel, subzero treatment
- Hardness HRC58-60

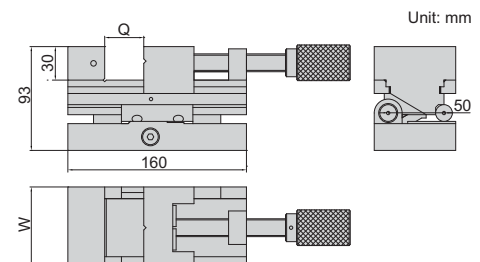
Code	Jaw opening (Q)	Jaw width (W)	Adjustable angle
6522-80	0-80mm	73mm	0-46°

PRECISION SINE VISE

There is a 1mm step (accuracy +/-0.002mm). Gage blocks smaller than 0.5mm are not available. If small gage blocks are needed (for example, 0.25mm), a gage block 1.25mm can be used in order to make 1.25mm - 1mm = 0.25mm.



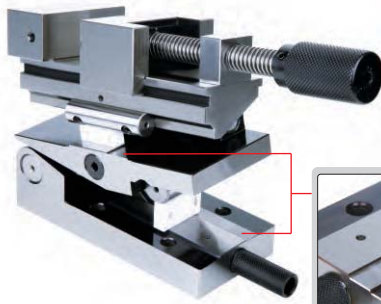
6523-80



- Parallelism: 3μm/100mm
- Squareness: 5μm/100mm
- Accuracy of angle: ±15 seconds
- Made of SKS tool steel, subzero treatment
- Hardness HRC58-60

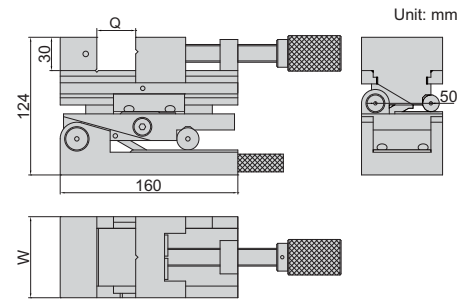
Code	Jaw opening (Q)	Jaw width (W)	Adjustable angle
6523-80	0-80mm	73mm	0-46°

PRECISION COMPOUND SINE VISE



6524-80

There is a 1mm step (accuracy +/-0.002mm). Gage blocks smaller than 0.5mm are not available. If small gage blocks are needed (for example, 0.25mm), a gage block 1.25mm can be used in order to make 1.25mm - 1mm = 0.25mm.

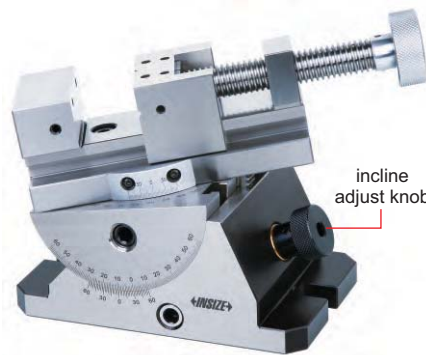


- Parallelism: 3µm/100mm
- Squareness: 5µm/100mm
- Accuracy of angle: ±15 seconds
- Made of SKS tool steel, subzero treatment
- Hardness HRC58-60

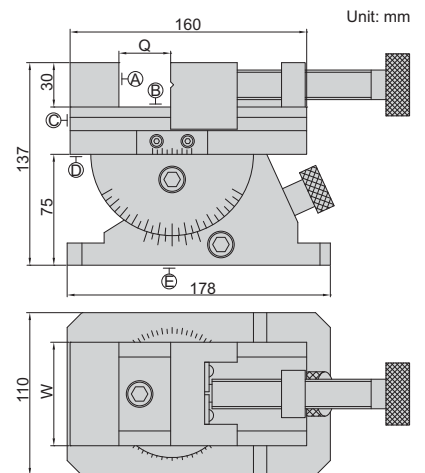
Code	Jaw opening (Q)	Jaw width (W)	Adjustable angle
6524-80	0-80mm	73mm	0-46°

PRECISION UNIVERSAL VISE

- Horizontal rotary: range 360°, graduation 0.05°
- Vertical incline: range 45°, graduation 0.05°
- With incline adjust knob
- Parallelism and squareness between A, B, C and D: 5µm/100mm, parallelism between D and E at 0°: 10µm/100mm
- Made of tool steel
- Hardness HRC56-58



6521-80

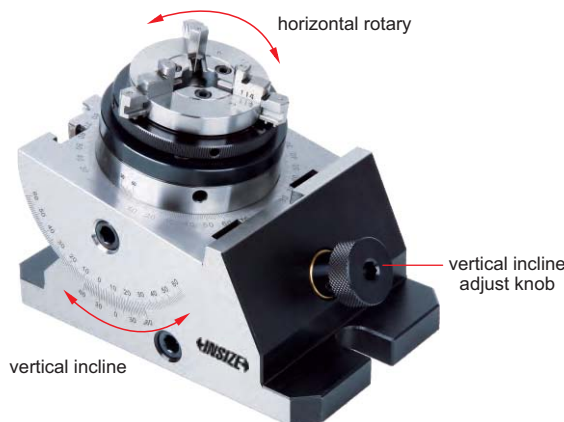


Code	Jaw opening (Q)	Jaw width (W)
6521-80	0-80mm	70mm

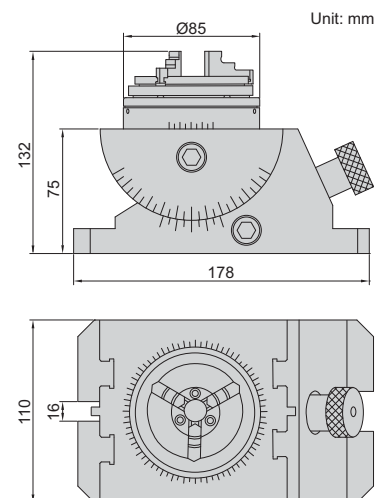
12

PRECISION UNIVERSAL VISE WITH CHUCK

- Horizontal rotary: range 360°, graduation 0.05°
- Vertical incline: range 45°, graduation 0.05°
- With vertical incline adjust knob
- Runout of chuck is less than 0.05mm (test position is at less than 50mm from clamping jaws)
- The clamping jaws of chuck are reversible
- Made of tool steel
- Hardness HRC56-58



6528-85



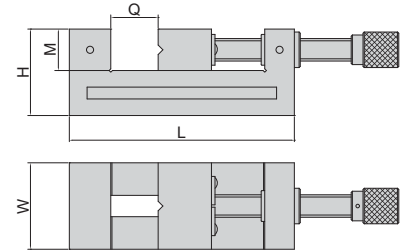
Code	Range of external clamping	Range of internal clamping
6528-85	Ø0.8~Ø63mm	Ø23~Ø58mm

PRECISION VISES

- Parallelism: 8µm/100mm
- Squareness: 10µm/100mm
- Made of alloy steel
- Hardness HRC56-58



6520-73A



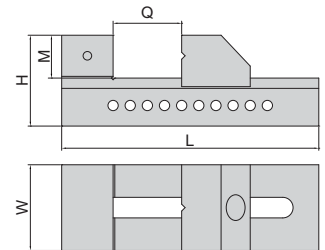
Code	Jaw opening (Q)	Jaw width (W)	L	H	M
6520-73A	0-73mm	63mm	176mm	63mm	30mm
6520-76A	0-76mm	73mm	190mm	73mm	35mm
6520-120A	0-120mm	98mm	255mm	82mm	40mm

PRECISION VISES

- Parallelism: 3µm/100mm
- Squareness: 5µm/100mm
- Made of alloy steel
- Hardness HRC56-58

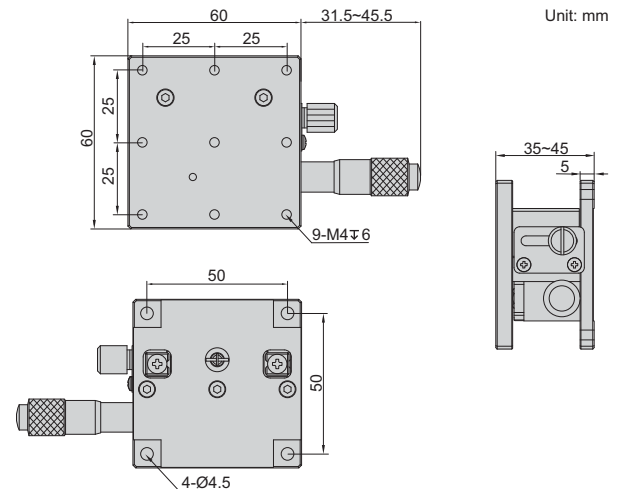


6526-80



Code	Jaw opening (Q)	Jaw width (W)	Overall length (L)	H	M
6526-80	0-80mm	50mm	150mm	53mm	25mm
6526-100	0-100mm	73mm	190mm	70mm	35mm

Z-AXIS STAGE CODE 6586-60



- Cross roller guides, achieve high precision and smooth movement
- Stage made of aluminum alloy

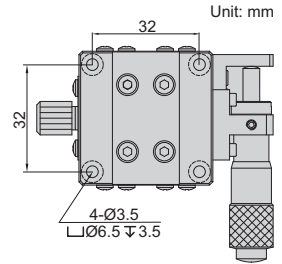
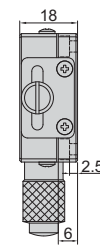
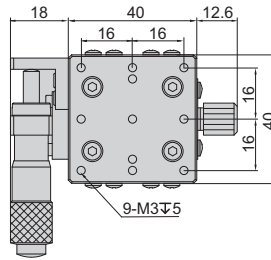
SPECIFICATION

Code	Z-axis displacement	Parallelism of top to bottom surface	Micrometer graduation	Micrometer accuracy	Maximum load	Stage size	Weight
6586-60	10mm	0.05mm	0.01mm	0.02mm	20.4N (3kgf)	60x60mm	0.27kg

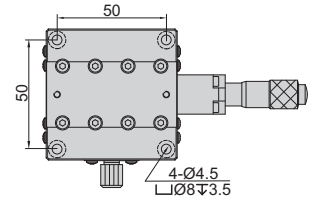
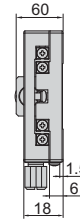
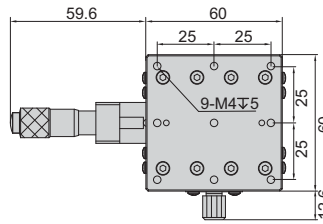
X-AXIS STAGES



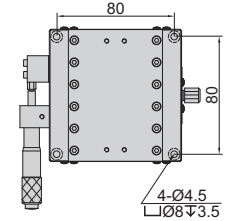
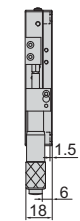
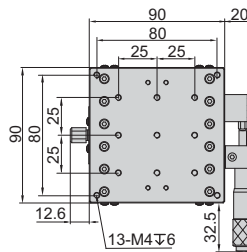
6582-401



6582-602



6582-903



- Cross roller guides, achieve high precision and smooth movement
- Stages made of aluminum alloy

SPECIFICATION (micrometer on the left)

Code	X-axis displacement	Parallelism of top to bottom surface	Micrometer graduation	Micrometer accuracy	Maximum load	Micrometer location	Stage size	Weight
6582-401	±6.5mm	0.02mm	0.01mm	0.01mm	29.4N (3kgf)	left	40x40mm	0.14kg
6582-601	±6.5mm	0.03mm	0.01mm	0.01mm	49N (5kgf)	left	60x60mm	0.24kg
6582-901	±12.5mm	0.03mm	0.01mm	0.02mm	93.1N (9.5kgf)	left	90x90mm	0.47kg
6582-1251	±12.5mm	0.04mm	0.01mm	0.02mm	180N (18.4kgf)	left	125x125mm	1.40kg

SPECIFICATION (micrometer in the middle)

Code	X-axis displacement	Parallelism of top to bottom surface	Micrometer graduation	Micrometer accuracy	Maximum load	Micrometer location	Stage size	Weight
6582-402	±6.5mm	0.02mm	0.01mm	0.01mm	29.4N (3kgf)	middle	40x40mm	0.14kg
6582-602	±6.5mm	0.03mm	0.01mm	0.01mm	49N (5kgf)	middle	60x60mm	0.24kg
6582-902	±12.5mm	0.03mm	0.01mm	0.02mm	93.1N (9.5kgf)	middle	90x90mm	0.47kg
6582-1252	±12.5mm	0.04mm	0.01mm	0.02mm	180N (18.4kgf)	middle	125x125mm	1.40kg

SPECIFICATION (micrometer on the right)

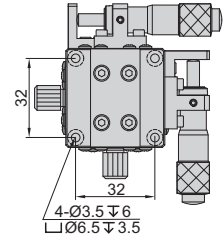
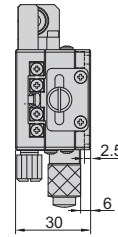
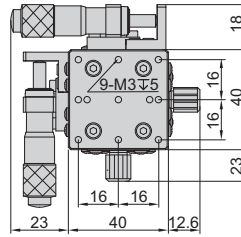
Code	X-axis displacement	Parallelism of top to bottom surface	Micrometer graduation	Micrometer accuracy	Maximum load	Micrometer location	Stage size	Weight
6582-403	±6.5mm	0.02mm	0.01mm	0.01mm	29.4N (3kgf)	right	40x40mm	0.14kg
6582-603	±6.5mm	0.03mm	0.01mm	0.01mm	49N (5kgf)	right	60x60mm	0.24kg
6582-903	±12.5mm	0.03mm	0.01mm	0.02mm	93.1N (9.5kgf)	right	90x90mm	0.47kg
6582-1253	±12.5mm	0.04mm	0.01mm	0.02mm	180N (18.4kgf)	right	125x125mm	1.40kg

XY-AXIS STAGES

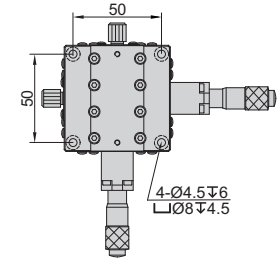
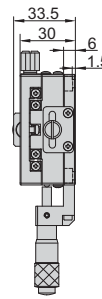
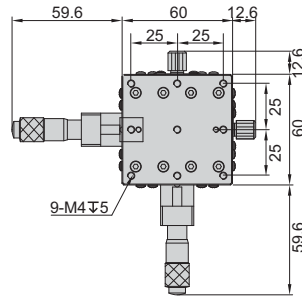
Unit: mm



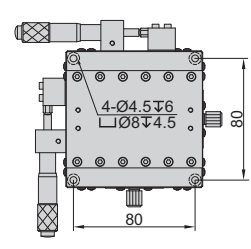
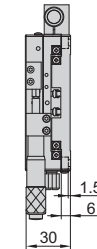
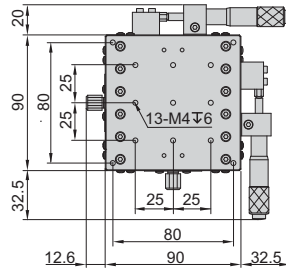
6584-401



6584-602



6584-903



- Cross roller guides, achieve high precision and smooth movement
- Stages made of aluminum alloy

SPECIFICATION (micrometer on the left)

Code	XY-axis displacement	Parallelism of top to bottom surface	Micrometer graduation	Micrometer accuracy	Maximum load	Micrometer location	Stage size	Weight
6584-401	±6.5mm	0.04mm	0.01mm	0.01mm	29.4N (3kgf)	left	40x40mm	0.27kg
6584-601	±6.5mm	0.06mm	0.01mm	0.01mm	49N (5kgf)	left	60x60mm	0.48kg
6584-901	±12.5mm	0.06mm	0.01mm	0.02mm	93.1N (9.5kgf)	left	90x90mm	1kg
6584-1251	±12.5mm	0.08mm	0.01mm	0.02mm	180N (18.4kgf)	left	125x125mm	2.8kg

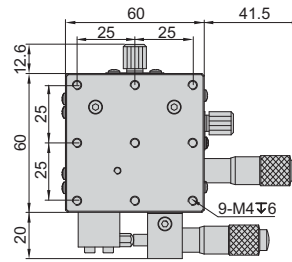
SPECIFICATION (micrometer in the middle)

Code	XY-axis displacement	Parallelism of top to bottom surface	Micrometer graduation	Micrometer accuracy	Maximum load	Micrometer location	Stage size	Weight
6584-402	±6.5mm	0.04mm	0.01mm	0.01mm	29.4N (3kgf)	middle	40x40mm	0.27kg
6584-602	±6.5mm	0.06mm	0.01mm	0.01mm	49N (5kgf)	middle	60x60mm	0.48kg
6584-902	±12.5mm	0.06mm	0.01mm	0.02mm	93.1N (9.5kgf)	middle	90x90mm	1kg
6584-1252	±12.5mm	0.08mm	0.01mm	0.02mm	180N (18.4kgf)	middle	125x125mm	2.8kg

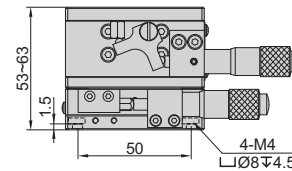
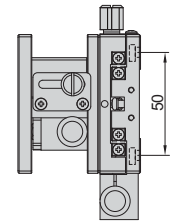
SPECIFICATION (micrometer on the right)

Code	XY-axis displacement	Parallelism of top to bottom surface	Micrometer graduation	Micrometer accuracy	Maximum load	Micrometer location	Stage size	Weight
6584-403	±6.5mm	0.04mm	0.01mm	0.01mm	29.4N (3kgf)	right	40x40mm	0.27kg
6584-603	±6.5mm	0.06mm	0.01mm	0.01mm	49N (5kgf)	right	60x60mm	0.48kg
6584-903	±12.5mm	0.06mm	0.01mm	0.02mm	93.1N (9.5kgf)	right	90x90mm	1kg
6584-1253	±12.5mm	0.08mm	0.01mm	0.02mm	180N (18.4kgf)	right	125x125mm	2.8kg

XZ-AXIS STAGE CODE 6587-60



Unit: mm



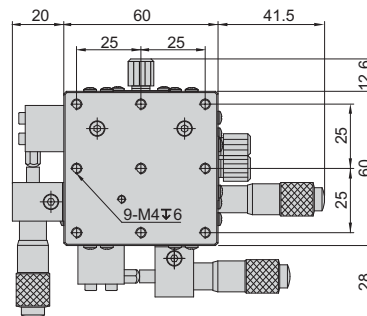
- Cross roller guides, achieve high precision and smooth movement
- Stage made of aluminum alloy

SPECIFICATION

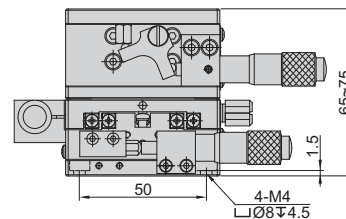
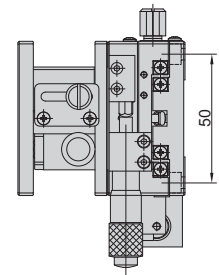
Code	X-axis displacement	Z-axis displacement	Micrometer graduation	Maximum load	Stage size	Weight
6587-60	±6.5mm	10mm	0.01mm	29.4N (3kgf)	60x60mm	0.51kg

12

XYZ-AXIS STAGE CODE 6585-60



Unit: mm



- Cross roller guides, achieve high precision and smooth movement
- Stage made of aluminum alloy

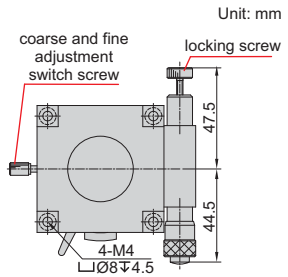
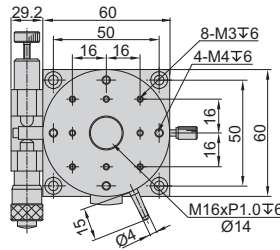
SPECIFICATION

Code	XY-axis displacement	Z-axis displacement	Micrometer graduation	Maximum load	Stage size	Weight
6585-60	±6.5mm	10mm	0.01mm	29.4N (3kgf)	60x60mm	0.75kg

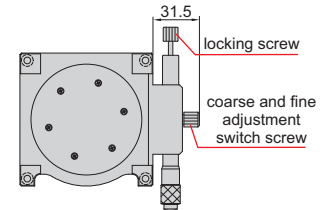
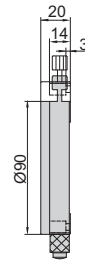
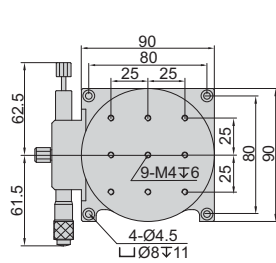
ROTARY STAGES



6583-60H



6583-90



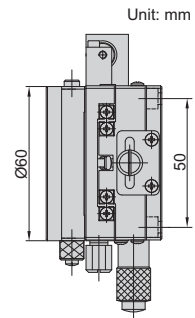
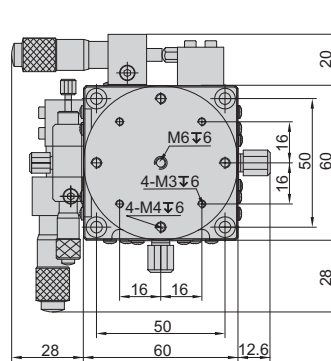
- Precise angle adjustment
- Coarse and fine adjustments
- Stages made of aluminum alloy

12

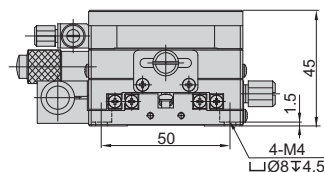
SPECIFICATION

Code	Range	Parallelism of top to bottom surface	Concentricity	Rotation accuracy	Maximum load	Stage size	Weight
6583-60H	360° coarse, ±5° fine	0.03mm	0.03mm	12'	29.4N (3kgf)	Ø60mm	0.30kg
6583-90	360° coarse, ±5° fine	0.04mm	0.03mm	5'	29.4N (3kgf)	Ø90mm	0.50kg

XY-AXIS ROTARY STAGE CODE 6588-60



- Cross roller guides, achieve high precision and smooth movement
- Coarse and fine adjustments
- Precise angle adjustment
- Stage made of aluminum alloy



SPECIFICATION

Code	XY-axis displacement	Rotation range	Micrometer graduation	Rotation accuracy	Maximum load	Stage size	Weight
6588-60	±6.5mm	360° coarse, ±5° fine	0.01mm	10'	29.4N (3kgf)	60x60mm	0.64kg

CENTERING INDICATOR



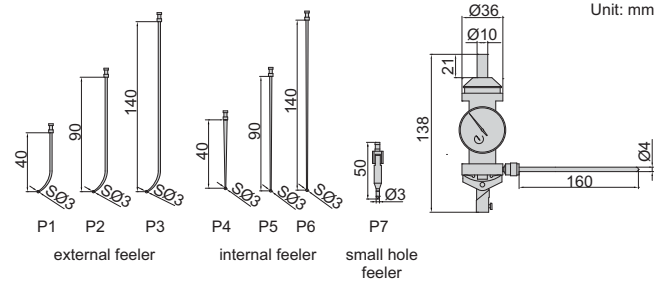
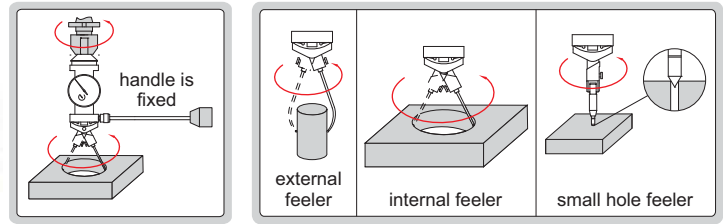
2385-3

- Provides quick and accurate centering in boring and milling set-up

Code
2385-3



Feeler	Measuring diameter	Accuracy
P1	Ø0-60mm	0.015mm
P2	Ø0-160mm	0.02mm
P3	Ø0-250mm	0.03mm
P4	Ø3.2-80mm	0.015mm
P5	Ø3.2-180mm	0.02mm
P6	Ø3.2-280mm	0.03mm
P7	Ø0-2.8mm	0.015mm



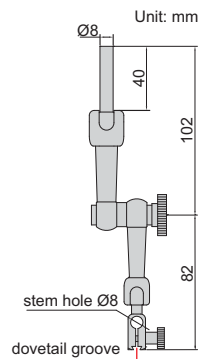
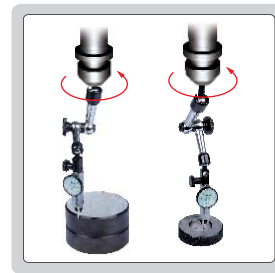
DIAL TEST INDICATOR CENTERING HOLDER

- Center cylinders or holes on machine tools
- Can be used with dial test indicators

Code
6295-1A



6295-1A



INDICATOR CENTERING HOLDER

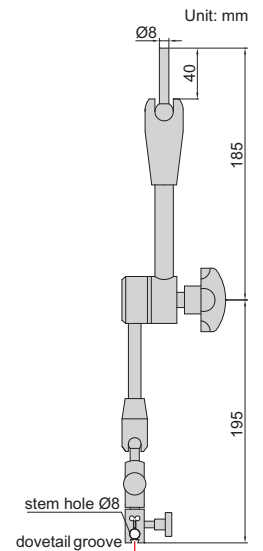


- Center cylinders or holes on machine tools
- Can be used with dial test indicators or dial indicators

Code
6294-1A

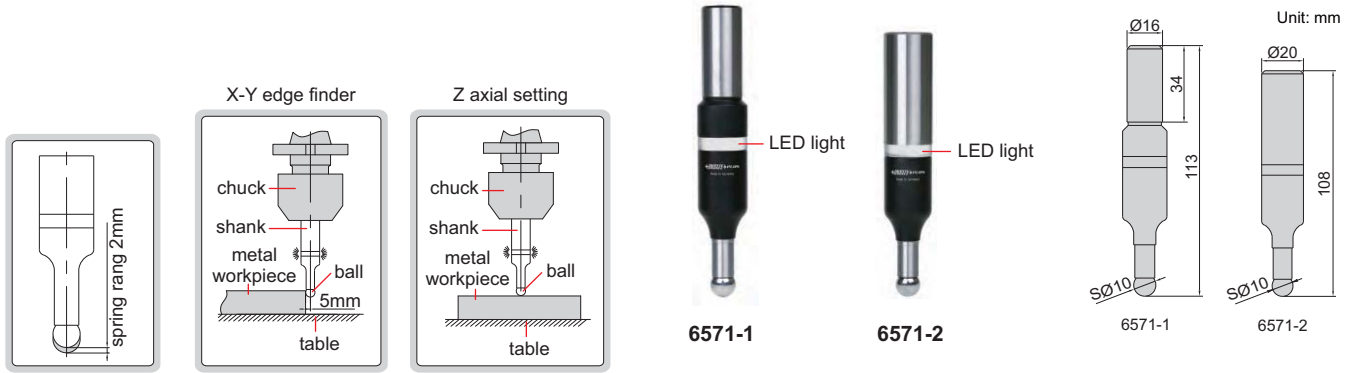


6294-1A



3D ELECTRONIC EDGE FINDERS

INSIZE PLUS
MADE IN EUROPE



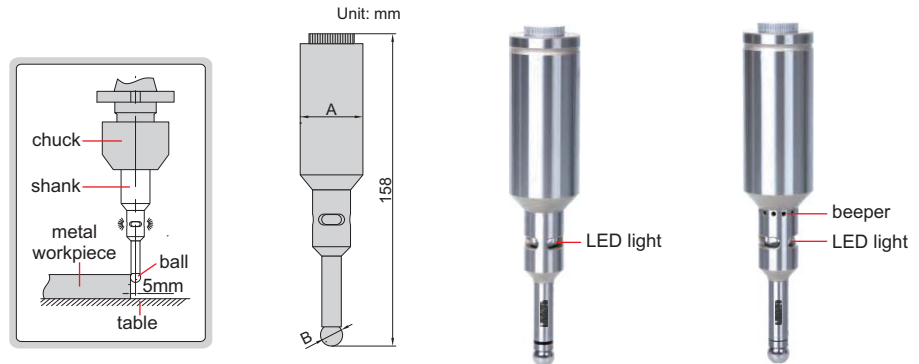
Code	Shank	Contact ball	Accuracy	Battery
6571-1	Ø16mm	SØ10mm	10µm	23A, 12Vx1 pc
6571-2	Ø20mm	SØ10mm	10µm	23A, 12Vx1 pc

- The shank is electrically conducted to the metal workpiece through the chuck and table. The LED lights up, when the ball touches the workpiece
- Not suitable for rotary use
- Hardened contact ball

LARGE SHANK ELECTRONIC EDGE FINDERS

12

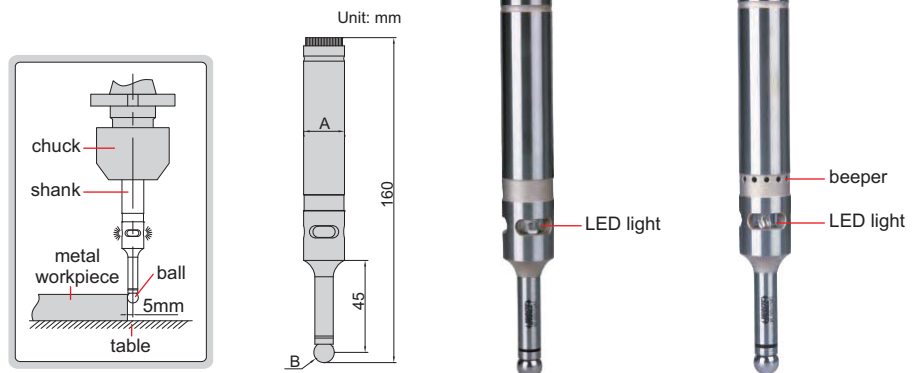
- The shank is electrically conducted to the metal workpiece through the chuck and table. The LED lights up and the beeper sounds (only for 6572-2), when the ball touches the workpiece
- Not suitable for rotary use
- Hardened shank and contact ball



Code	Shank (A)	Contact ball (B)	Accuracy	Beeper	Battery
6572-1	Ø32mm	SØ10mm	5µm	without	23A, 12Vx1 pc
6572-2	Ø32mm	SØ10mm	5µm	with	23A, 12Vx1 pc

ELECTRONIC EDGE FINDERS

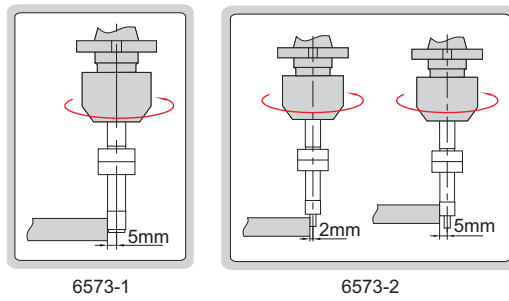
- The shank is electrically conducted to the metal workpiece through the chuck and table. The LED lights up and the beeper sounds (only for 6566-3), when the ball touches the workpiece
- Not suitable for rotary use
- Hardened shank and contact ball



Code	Shank (A)	Contact ball (B)	Accuracy	Beeper	Battery
6566-2	Ø20mm	SØ10mm	5µm	without	23A, 12Vx1 pc
6566-3	Ø20mm	SØ10mm	5µm	with	23A, 12Vx1 pc

NON-MAGNETIC EDGE FINDERS

- TiAlN coating, non-magnetic, hardness HV2500, extremely wear resistance
- Suitable for machine speed 400~600rpm



6573-1

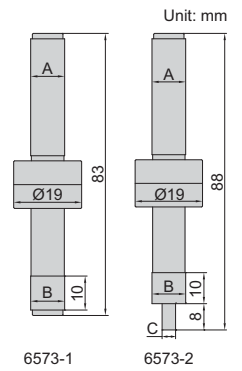
6573-2

Code	Shank (A)	Contact point (B)	Contact point (C)	Accuracy
6573-1	Ø10mm	Ø10mm	—	5µm
6573-2	Ø10mm	Ø10mm	Ø4mm	5µm



6573-1

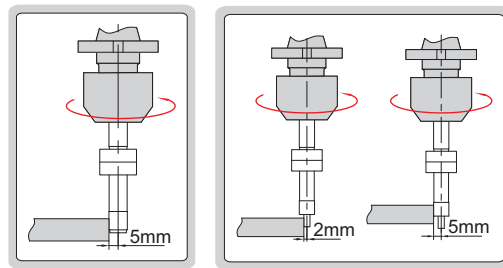
6573-2



6573-1

6573-2

- Hardened shank and contact point
- Suitable for machine speed 400~600rpm



6562-3

6562-4

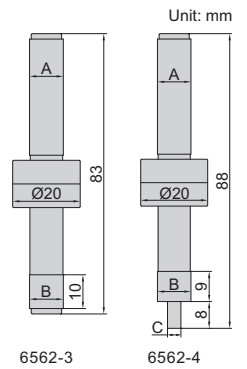
Code	Shank (A)	Contact point (B)	Contact point (C)	Accuracy
6562-3	Ø10mm	Ø10mm	—	5µm
6562-4	Ø10mm	Ø10mm	Ø4mm	5µm



6562-3

6562-4

EDGE FINDERS



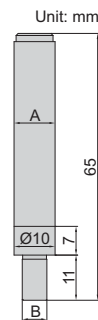
6562-3

6562-4

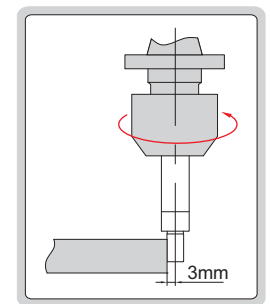
EDGE FINDER

- Hardened shank and contact point
- Suitable for machine speed 400~600rpm

Code	Shank (A)	Contact point (B)	Accuracy
6567-1	Ø10mm	Ø6mm	8µm

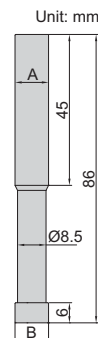


6567-1

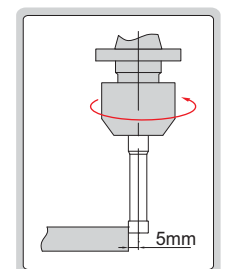


- Ceramic contact point, non magnetic
- Suitable for machine speed 400~600rpm

Code	Shank (A)	Contact point (B)	Accuracy
6568-1	Ø10mm	Ø10mm	8µm



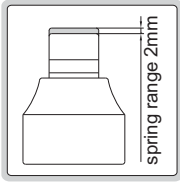
6568-1



ELECTRONIC ZERO SETTER

INSIZE PLUS
MADE IN EUROPE

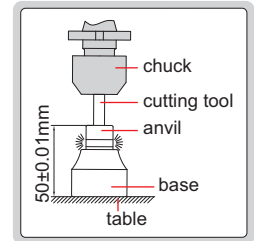
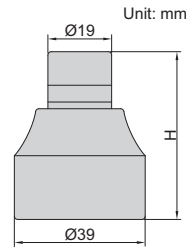
LOW TEST FORCE



- The base is electrically conducted to the cutting tools through the table and chuck. The LED lights up when the cutting tool touches the anvil
- Magnetic base
- Two batteries LR44



6553-50

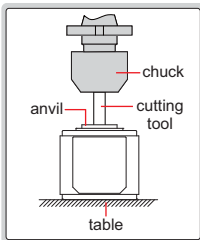


Code	Height (H)	Accuracy	Test force
6553-50	50mm	±10µm	7N (at 49mm)

DIGITAL ZERO SETTER

IP65
WATERPROOF

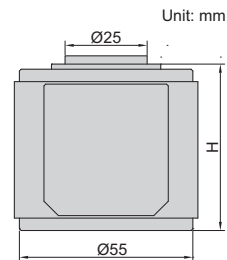
12



- Resolution: 0.001mm/0.00005"
- IP65 dust/waterproof
- Buttons: on/off, mm/inch, zero
- CR2032 battery
- Automatic power off
- Magnetic base
- Automatic backlight at zero



6557-50



automatic backlight at zero



set zero

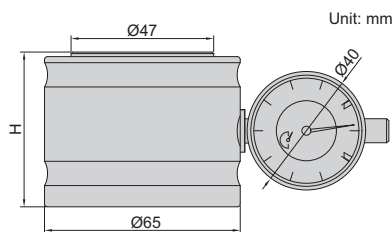


Code	Height (H)	Anvil stroke	Accuracy*	Test force	Repeatability
6557-50	50mm	2.5mm	±10µm/0.0004"	4N (at 50mm)	2µm

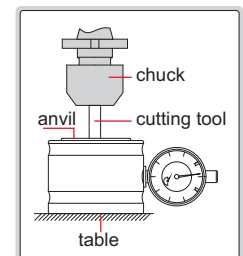
*The accuracy is ensured within Ø10mm of the center

ZERO SETTER

INSIZE PLUS
MADE IN EUROPE

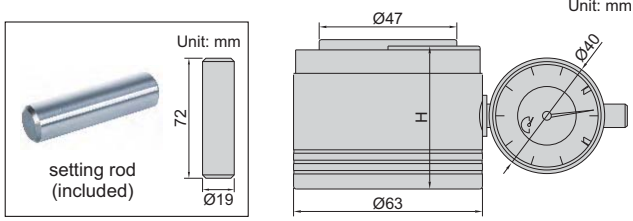


6554-50



Code	Height (H)	Accuracy	Test force
6554-50	50mm	±10µm	9N (at 50mm)

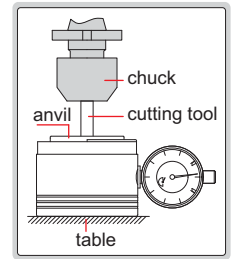
ZERO SETTER



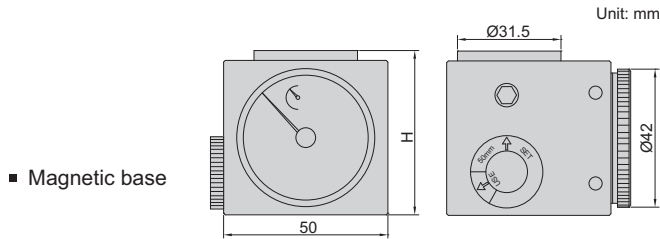
Code	Height (H)	Accuracy	Test force
6556-50	50mm	±10µm	10N (at 50mm)



6556-50



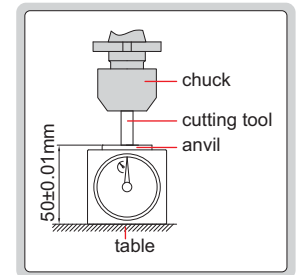
ZERO SETTER



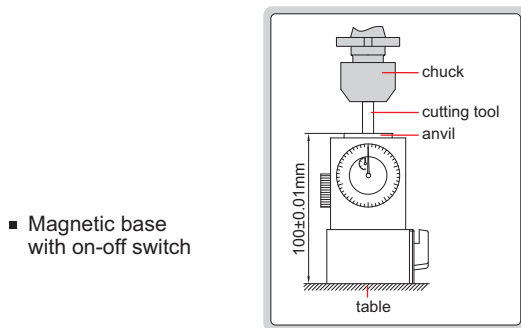
Code	Height (H)	Accuracy	Test force
2397-502A	50mm	±10µm	9N (at 50mm)



2397-502A



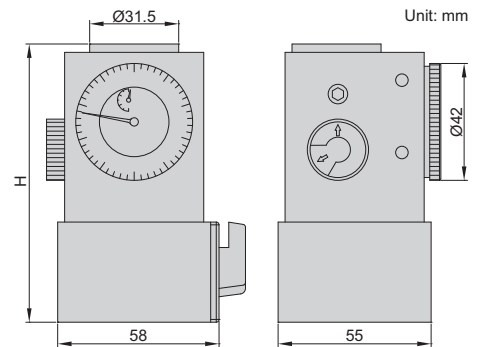
ZERO SETTER



Code	Height (H)	Accuracy	Test force
2394-100A	100mm	±10µm	9N (at 100mm)

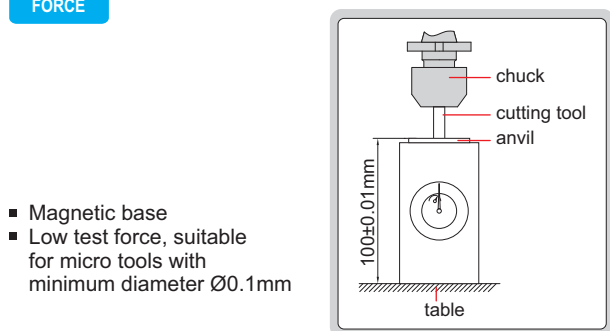


2394-100A



LOW TEST FORCE

LOW TEST FORCE ZERO SETTER

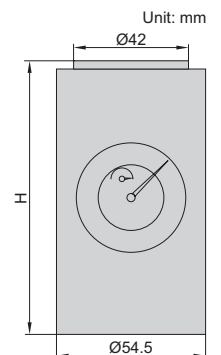


Code	Height (H)	Accuracy	Test force
6555-100B	100mm	±10µm	1N (at 100mm)



6555-100B

INSIZE PLUS
MADE IN EUROPE



DIGITAL HORIZONTAL SCALES

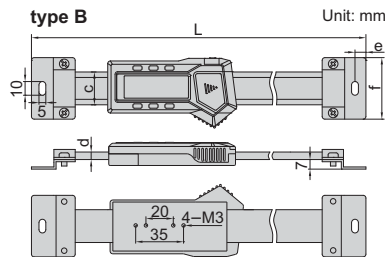
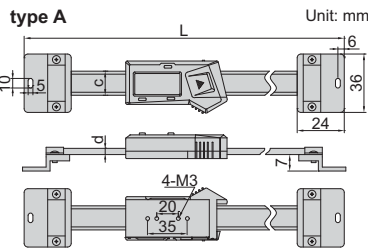
DATA OUTPUT



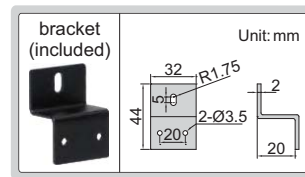
7101-300A



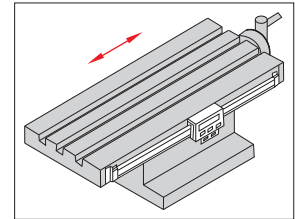
7101-400A



- Resolution: 0.01mm/0.0005"
- Buttons type A: on/off, zero, mm/inch, type B: on/off, zero, mm/inch, ABS, data preset
- Automatic power off, move the digital unit to turn on power
- Battery CR2032
- Data output
- Made of stainless steel
- Supplied with bracket to be mounted on the back



example of application



With data interface (data output cable code 7315-21, 7302-21, optional) (mm)

Code	Range	Type	Accuracy	L	c	d
7101-100A	100mm	A	±0.02mm	215	16	4
7101-150A	150mm	A	±0.03mm	265	16	4
7101-200A	200mm	A	±0.03mm	315	16	4
7101-300A	300mm	A	±0.04mm	445	16	4

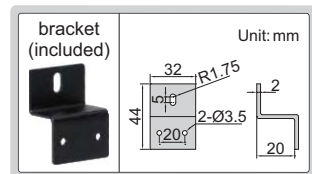
With data interface (data output cable code 7315-22, 7302-22, optional) (mm)

Code	Range	Type	Accuracy	L	c	d	e	f
7101-400A	400mm	B	±0.05mm	590	24	5.5	8	45
7101-500A	500mm	B	±0.05mm	690	24	5.5	8	45
7101-600A	600mm	B	±0.08mm	790	24	5.5	8	45
7101-800A	800mm	B	±0.10mm	990	24	5.5	8	45
7101-1000A	1000mm	B	±0.10mm	1240	31	10.5	10	60

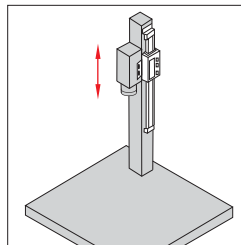
13

DIGITAL VERTICAL SCALES

DATA OUTPUT



example of application



data output cable



7302-SPC7

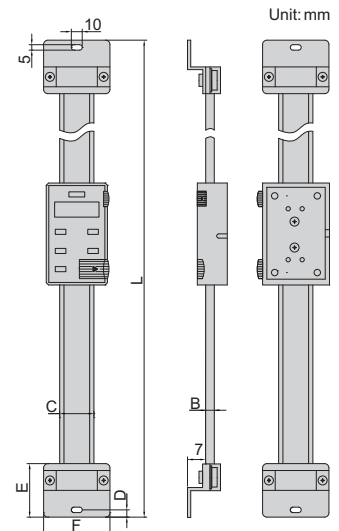
- Resolution: 0.01mm/0.0005"
- Buttons: on/off, zero, mm/inch, ABS/INC, data hold, TOL, set
- Battery LR44, data output
- Made of stainless steel
- Supplied with bracket to be mounted on the back
- Optional accessory: data output cable (code 7302-SPC7, keyboard format)

Code	Range	Accuracy	B	C	D	E	F	L
7102-100	100mm/4"	±0.02mm	4	20	6	24	40	245
7102-150	150mm/6"	±0.03mm	4	20	6	24	40	296
7102-200	200mm/8"	±0.03mm	4	20	6	24	40	345
7102-300	300mm/12"	±0.04mm	4	20	6	24	40	445
7102-400	400mm/16"	±0.05mm	4	20	6	24	40	545
7102-500	500mm/20"	±0.05mm	5.5	24	8	32	45	685
7102-600	600mm/24"	±0.08mm	5.5	24	8	32	45	785
7102-800	800mm/32"	±0.10mm	5.5	24	8	32	45	985
7102-1000	1000mm/40"	±0.10mm	10.5	31	25	40	60	1245

(mm)



7102-300

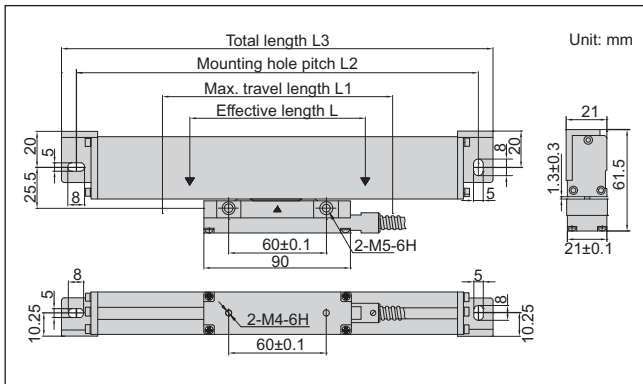


LINEAR SCALES

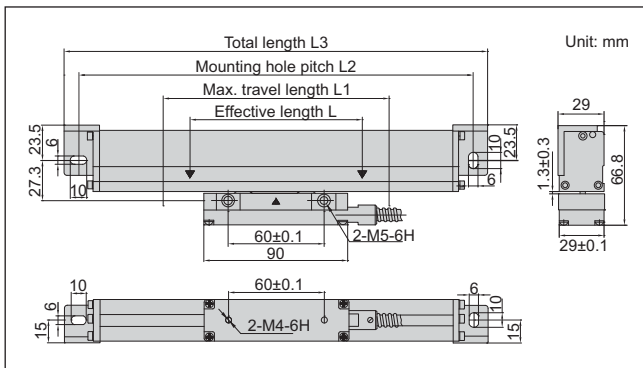


ISL-A1-300

Series ISL-A1 and ISL-A5



Series ISL-B5



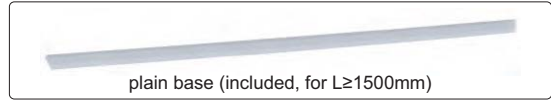
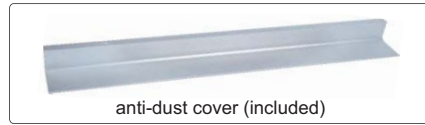
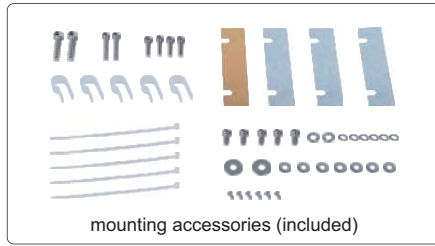
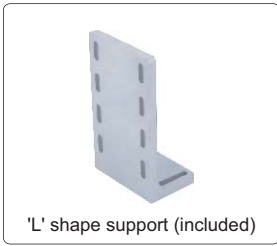
STANDARD DELIVERY

Main unit	1 pc
'L' shape support	1 pc
Anti-dust cover	1 pc
Plain base	1 pc (for L≥1500mm)
Mounting accessories	1 package

Effective length (L)	Code		
	Series ISL-A1	Series ISL-A5	Series ISL-B5
50mm	ISL-A1-50	ISL-A5-50	ISL-B5-50
100mm	ISL-A1-100	ISL-A5-100	ISL-B5-100
150mm	ISL-A1-150	ISL-A5-150	ISL-B5-150
200mm	ISL-A1-200	ISL-A5-200	ISL-B5-200
250mm	ISL-A1-250	ISL-A5-250	ISL-B5-250
300mm	ISL-A1-300	ISL-A5-300	ISL-B5-300
350mm	ISL-A1-350	ISL-A5-350	ISL-B5-350
400mm	ISL-A1-400	ISL-A5-400	ISL-B5-400
450mm	ISL-A1-450	ISL-A5-450	ISL-B5-450
500mm	ISL-A1-500	ISL-A5-500	ISL-B5-500
550mm	ISL-A1-550	ISL-A5-550	ISL-B5-550
600mm	ISL-A1-600	ISL-A5-600	ISL-B5-600
650mm	ISL-A1-650	ISL-A5-650	ISL-B5-650
700mm	ISL-A1-700	ISL-A5-700	ISL-B5-700
750mm	ISL-A1-750	ISL-A5-750	ISL-B5-750
800mm	ISL-A1-800	ISL-A5-800	ISL-B5-800
850mm	ISL-A1-850	ISL-A5-850	ISL-B5-850
900mm	ISL-A1-900	ISL-A5-900	ISL-B5-900
950mm	ISL-A1-950	ISL-A5-950	ISL-B5-950
1000mm	ISL-A1-1000	ISL-A5-1000	ISL-B5-1000
1100mm		ISL-A5-1100	ISL-B5-1100
1200mm			ISL-B5-1200
1300mm			ISL-B5-1300
1400mm			ISL-B5-1400
1500mm			ISL-B5-1500
1600mm			ISL-B5-1600
1700mm			ISL-B5-1700
1800mm			ISL-B5-1800
1900mm			ISL-B5-1900
2000mm			ISL-B5-2000
2100mm			ISL-B5-2100
2200mm			ISL-B5-2200
2300mm			ISL-B5-2300
2400mm			ISL-B5-2400
2500mm			ISL-B5-2500
2600mm			ISL-B5-2600
2700mm			ISL-B5-2700
2800mm			ISL-B5-2800
2900mm			ISL-B5-2900
3000mm			ISL-B5-3000
3100mm			ISL-B5-3100
3200mm			ISL-B5-3200

To be continued

Continued from previous page



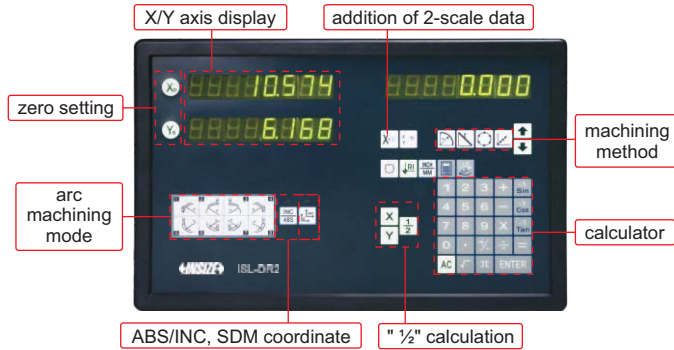
SPECIFICATION

Code	Series ISL-A1		Series ISL-A5		Series ISL-B5	
L1 (mm)	L+30(L<950)	L+50(L≥950)	L+30(L<950)	L+50(L≥950)	L+30(L<950)	L+50(L≥950)
L2 (mm)	L+132(L<950)	L+152(L≥950)	L+132(L<950)	L+152(L≥950)	L+136(L<950)	L+156(L≥950)
L3 (mm)	L+149(L<950)	L+169(L≥950)	L+149(L<950)	L+169(L≥950)	L+154(L<950)	L+174(L≥950)
Resolution	1μm		5μm		5μm	
Max. response speed	50m/min		90m/min		60m/min	
Scale grating pitch	20μm					
Scale reference point pitch	50mm					
Accuracy	±(5+5L/1000)μm L is the effective length in mm					
Cable length	3.5m (L: 50-950mm), 5m (L: 1000-1500mm), 10m (L: 1600-3200mm)					

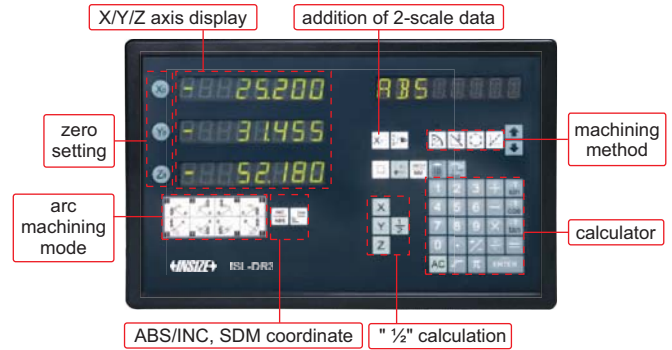
DIGITAL READOUTS



13



ISL-DR2



ISL-DR3

SPECIFICATION

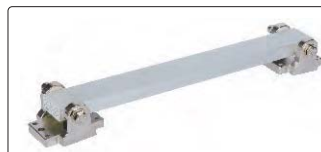
Code	ISL-DR2	ISL-DR3
Application	two-axis	three-axis
Scale input ports	2	3
Resolution	0.05μm, 0.1μm, 0.2μm, 0.5μm, 1μm, 2μm, 5μm, 10μm, 20μm, 50μm	
Functions	addition of 2-scale data, linearity error compensation, smoothing, RS232C interface unit, BCD code out, zero setting, preset, resolution setting, counting direction setting, inch/mm conversion, ABS/INC conversion, expansion/contraction coefficient setting, "1/2" calculation, detecting RI, bolt-hole circle machining, ramp circle machining	
Power supply	110/220V, 50/60Hz	
Dimension	295×185×45mm	
Weight	1.45kg	

STANDARD DELIVERY

Main unit	1 pc
Mounting bracket	1 pc
Ground cable	1 pc
RS232C cable	1 pc
Software CD for RS232C	1 pc



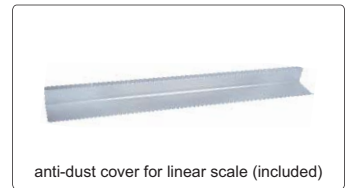
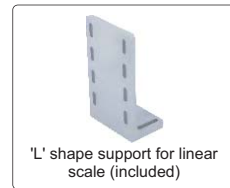
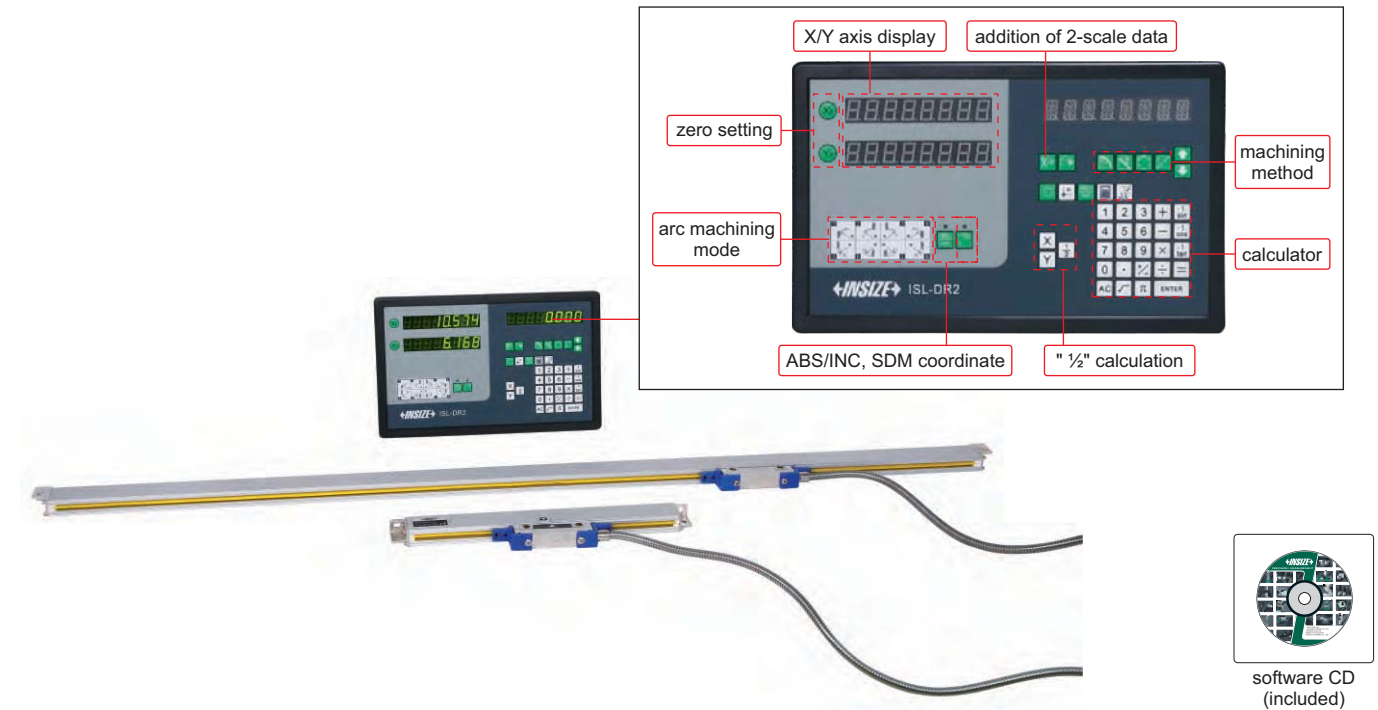
software CD (included)



mounting bracket (included)



2-AXIS DIGITAL READOUT SYSTEM FOR LATHE CODE ISL-SET1



READOUT SPECIFICATION

Application	two-axis
Scale input ports	2
Resolution	1 μ m
Functions	addition of 2-scale data, linearity error compensation, smoothing, RS232C interface unit, BCD code out, zero setting, preset, resolution setting, counting direction setting, inch/mm conversion, ABS/INC conversion, expansion/contraction coefficient setting, "1/2" calculation, detecting RI, bolt-hole circle machining, ramp circle machining
Power supply	110/220V, 50/60Hz
Dimension	295×185×45mm
Weight	1.45kg

LINEAR SCALE SPECIFICATION

X-axis	200mm
Y-axis	1000mm
Max. response speed	50m/min
Scale grating pitch	20 μ m
Scale reference point pitch	50mm
Accuracy	$\pm(5+5L/1000)\mu$ m L is the effective length in mm
Cable length	200mm scale: 3.5m, 1000mm scale: 5m

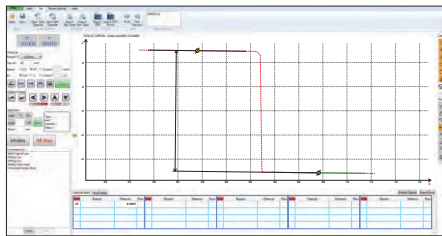
STANDARD DELIVERY

Readout box	1 pc
200mm linear scale	1 pc
1000mm linear scale	1 pc
Mounting bracket for readout	1 pc
Ground cable for readout	1 pc
RS232C cable for readout	1 pc
Software CD for RS232C of readout	1 pc
'L' shape support for linear scale	1 pc
Anti-dust cover for linear scale	1 pc
Mounting accessories for linear scale	1 package

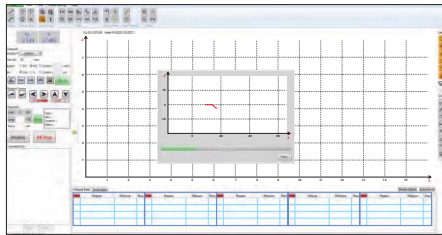
SURFACE PROFILE MEASURING MACHINE CODE SPM-1000



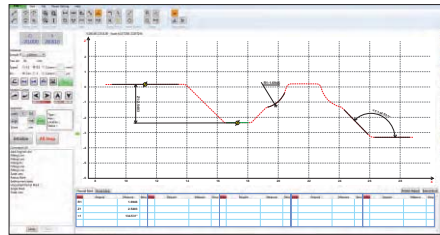
- Software is included, for surface profile measurement and data output
- Probe compensation
- Output as format txt, csv, etc.
- Large range design, the leverage ratio is 1:2.2, maintain the original accuracy of the sensor
- The overall structure of the Z-axis sensor does not have any elastic components, ensuring the measuring force is constant regardless the position of probe



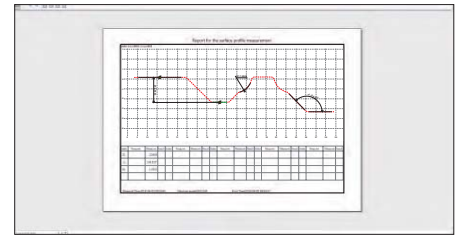
calibration



contour scanning



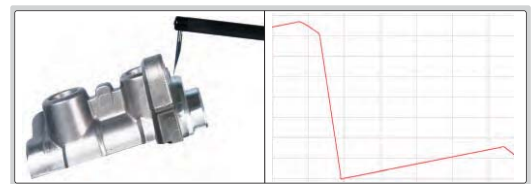
dimension measurement



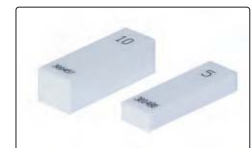
data output

SPECIFICATION

X axis measuring range	140mm
X axis resolution	0.2 μ m
X axis straightness	0.8 μ m/100mm
X axis traverse speed	0.1~10mm/s
Z axis measuring range	\pm 20mm
Z axis resolution	0.05 μ m
Z axis traverse speed	0.5~10mm/s
Linear accuracy	$\pm(1.5+ 0.2H)\mu$ m, H is measuring height in mm
Angular measuring accuracy	$\pm 2'$
Arc measuring accuracy	$\pm(2+R/8)\mu$ m, R is 2~10mm standard ball
Radius of probe tip	25 μ m
Traverse direction	backward
Measuring force	6.86~9.8mN
Measuring unit	mm/inch
Traceable angle	72° (upward), 87° (downward)
Drive mode	motor
Travel of Z axis	430mm
Dimension (L×W×H)	1200×700×1780mm
Power supply	220 \pm 5%V, 50Hz
Weight	320kg



standard balls (included)



standard blocks (included)



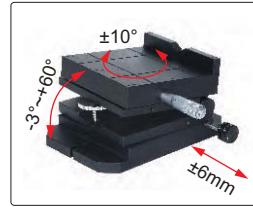
standard shaft (included)

To be continued

Continued from previous page

STANDARD DELIVERY

Main unit	1 pc
Standard probe and arm	1 pc of each
Standard block	2 pcs
Standard ball	2 pcs
Standard shaft	1 pc
Stage	1 pc
Vise	1 pc
Measuring arm	1 pc
Computer	1 pc
Measurement software	1 pc
Printer	1 pc
Installation tools	1 set



stage (included)



vise (included)

OPTIONAL ACCESSORY

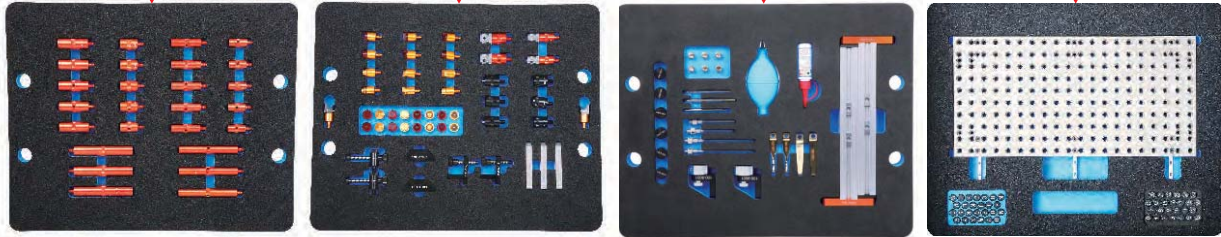
Probe and arm	see details
---------------	-------------

SPECIFICATION OF PROBES AND ARMS

Unit: mm

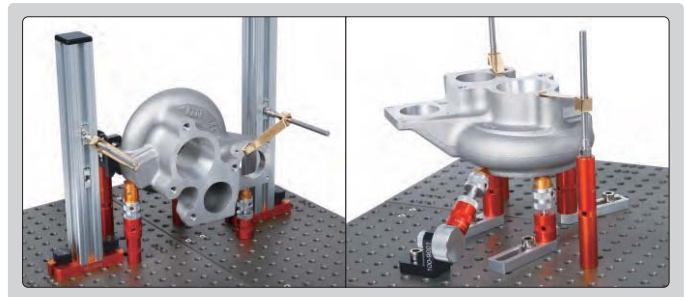
<p>chisel probes</p> <p>code SPM-1000-T01 (H=32mm, included) code SPM-1000-T02 (H=48mm, optional) code SPM-1000-T03 (H=68mm, optional)</p>	<p>cone probes</p> <p>code SPM-1000-Z01 (H=32mm, optional) code SPM-1000-Z02 (H=48mm, optional) code SPM-1000-Z03 (H=68mm, optional)</p>	<p>ball probes</p> <p>code SPM-1000-R01 (H=32mm, optional) code SPM-1000-R02 (H=48mm, optional) code SPM-1000-R03 (H=68mm, optional)</p>
<p>standard arm, code SPM-1000-SP (included), probe is not included</p>		<p>arm for small holes, code SPM-1000-SBP (optional), probe is included</p> <p>measure the contour of holes with diameter > Ø8mm</p>
<p>transverse arm, code SPM-1000-LP (optional), probe is not included</p> <p>measure the contour of holes in radial direction</p>		

JIG SET FOR CMM CODE ISY-100



ISY-100

application examples

















Product	Code	Size (mm)	Quantity	Application
	ISY-100-1001	Ø16×30	5	
	ISY-100-1002	Ø16×50	5	
	ISY-100-1003	Ø16×100	3	
	ISY-100-1004	Ø20×30	5	
	ISY-100-1005	Ø20×50	5	
	ISY-100-1006	Ø20×100	3	
stand with fine adjustment	ISY-100-2001	Ø16×45-60	2	height adjustment: 45-60mm
stand with fine adjustment	ISY-100-2003	Ø20×45-60	2	
horizontal spring stand	ISY-100-4001	—	2	

Product	Code	Size (mm)	Quantity	Application
horizontal screw stand	ISY-100-5001	—	2	
magnetic stand (magnetic top surface)	ISY-100-7001	Ø20×25	3	
stand for slice parts	ISY-100-8001	Ø20×25	2	ISY-100-8001 and ISY-100-8002 use cooperatively
clamping stand for slice parts	ISY-100-8002		1	









To be continued

Continued from previous page

Product	Code	Size (mm)	Quantity	Application
clip 	ISY-100-1201	—	2	
clip 	ISY-100-1301	—	2	
clip stand 	ISY-100-1401	Ø6×60	2	
	ISY-100-1402	Ø6×100	2	
vertical square column 	ISY-100-3003	30×30×250	2	
sliding support plate 	ISY-100-1801	78×20×10	3	
clamping screw 	ISY-100-2301	Ø8×20	6	
screw 	ISY-100-2302	Ø8×20	6	
base plate 	ISY-600-400200	400×400×12	2 pieces	—
wrench 	ISY-100-3701	Ø3.8×70	1	—
wrench 	ISY-100-3801	M2.5	1	—
	ISY-100-3802	M5	1	—
	ISY-100-3803	M6	1	—
45° stand 	ISY-100-9001	—	2	
V shaped support 	ISY-100-1901	—	2	

Product	Code	Quantity	Application
V shaped support 	ISY-100-1902	2	
marker 	ISY-6100-1501	52*	
dust cleaner 	ISY-100-3501	1	—
lubricating oil 	ISY-100-3601	1	—

*Letter A~Z, number 0~25

Product	Code	Quantity	Material	Application
support head 	ISY-100-27016	2	aluminum	
	ISY-100-27018	2	nylon	
support head 	ISY-100-27026	2	aluminum	
	ISY-100-27028	2	nylon	
support head 	ISY-100-27036	2	aluminum	
	ISY-100-27038	2	nylon	
support head 	ISY-100-27046	2	aluminum	
	ISY-100-27048	2	nylon	
support head 	ISY-100-27056	2	aluminum	
	ISY-100-27058	2	nylon	
support head 	ISY-100-27066	2	aluminum	
	ISY-100-27068	2	nylon	
support head 	ISY-100-27076	2	aluminum	
	ISY-100-27078	2	nylon	

MINI CNC CMM (SHOP FLOOR TYPE) CODE CMM-MN432

ATTENTION: MEASUREMENT ON THE LEFT SIDE OF WORKPIECES IS LIMITED



ATTENTION: ROTATION OF PROBE HEAD IS MANUAL

Can be used in shop floor, with the following features:

- Temperature compensation system, suitable for wide temperature range
- Water and oil resistance
- Compact design, small size
- Three sides open, easy to load and unload workpieces
- Without compress air
- Easy installation

FEATURES

- Integrated control system, safe, reliable and easy to operate
- High precision linear guide rail and ball screw for three axes
- 4 temperature sensors for X, Y, Z three axes and workpiece, suitable for wide temperature range

CONTROL SYSTEM

- Double computer control systems
- Driven by DC servo motor
- The control system supports communication with machine tools
- The control system has 12 buttons for customize

NET-DMIS SOFTWARE

- Can measure point, straight line, curve, circle, ellipse, plane, groove, cylinder, sphere, cone, ring, edge point, corner point, polygon, straightness, flatness, circularity, cylindricity, profile of a line, profile of a surface, perpendicularity, parallelism, angularity, coaxiality, concentricity, symmetry, position, composite position, circular runout and total runout
- Modular software structure, can support: temperature compensation, turning table, I/O interface
- Can program in offline mode and do virtual measurement based on CAD model, can extract the element features of CAD for programming
- Support dynamic point measurement and import DMO theoretical point coordinates for vector point measurement
- Can import and convert CAD model (SAT, IGES, STEP, STL)
- Can select multi language, metric and inch, polar and straight coordinate system
- Have multiple export ways: export measured data (SAT, IGES, STEP), report windows (PDF, HTML, MHT, RTF, EXCEL, CSV, txt, images, WORD, etc.), custom EXCEL template
- Support uploading the measuring result to server



CMM-MN432

SPECIFICATION

Code	CMM-MN432 ***
Measuring range (X×Y×Z)	400×200×300mm
Resolution	0.1μm
Repeatability	1μm
Accuracy (L is measuring range in mm)	±(4.5+L/200)μm (15°C~25°C, variation≤2°C/h) ±(5.5+L/200)μm (10°C~30°C, variation≤2°C/h)
Probe error	±5μm
Temperature	10°C~30°C, variation≤2°C/h
Humidity	40~60%
Power	220V±10%, 50Hz ***
Max. load	50kg
Dimension (L×W×H)	1270×1110×1630mm
Weight	280kg

*** Add "-U" on code No. when power supply is 110V, 50/60Hz

STYLUS (included) SPECIFICATION

Code	Material	Ball diameter	Length	Stem diameter	Effective working length	Quantity
PS2R	ruby ball / stainless steel stem	SØ2mm	20mm	Ø1.4mm	14mm	1 pc
PS17R		SØ4mm		Ø1.5mm	20mm	1 pc

EXTENSION (included) SPECIFICATION

Code	Material	Stem diameter	Length	Quantity
SE4	stainless steel	Ø3mm	10mm	1 pc
SE5			20mm	1 pc

STANDARD DELIVERY

Main unit		1 pc
Probe system	Probe head *	1 pc
	Probe *	1 pc
	Styli **	1 set
Calibration system	Datum sphere (Ø25mm)	1 pc
	Pivot pillar	1 pc
Computer system	Computer	1 pc
	Printer	1 pc
Temperature compensation system		1 pc
Software		1 pc

* The probe head and probe are Renishaw brand

** The styli system includes styli and extensions

PROBE (included) SPECIFICATION

Probe head	Angular movement with horizontal axis	0°~90° in 15 steps
	Angular movement with vertical axis	±180° in 15 steps
	Control mode	manual
	Number of positions	168
Probe	Probe mounting	M8
	Weight	210g
	Defect direction	±X, ±Y, +Z
	Styli mounting	M2
	Rating life	>1000,000 times
	Weight	22g

LASER SCAN MICROMETERS



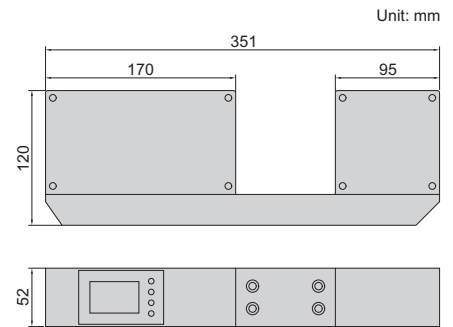
calibration gage (optional)



LDM-030



- Measure external diameter, ellipticity, run-out, maximum diameter of tools, etc.
- Can be used for transparent or non transparent workpieces
- Tolerance measurement
- Online or offline measurement
- Connected with computer and PLC



SPECIFICATION

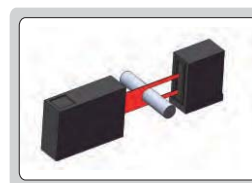
Code	LDM-030	LDM-065
Measuring range	0.1~30mm	0.5~65mm
Resolution	0.01/0.1/1/10/100μm selectable	
25°C accuracy	±(0.5+5%D)μm D is measuring diameter in mm	
Repeatability	0.2μm	0.4μm
Laser wave length	650nm	
Measuring speed	800~3200times/s (adjustable)	
Working temperature	0~50°C	
Working humidity	35~85RH without condensation	
Output	dual channel RS485	
Alarm output	24V, 1A	
Power supply	DC24V, 2A	
Dimension (L×W×H)	351×52×120mm	469×52×156mm
Weight	5kg	8kg

STANDARD DELIVERY

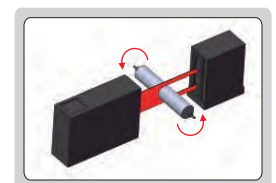
Main unit	1 pc
V-block	1 pc
AC/DC adapter	1 pc
RS485 cable	1 pc

OPTIONAL ACCESSORY

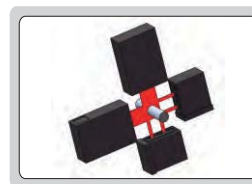
Calibration gage	custom made
------------------	-------------



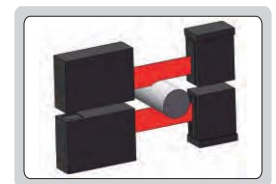
measure external diameter



measure ellipticity and run-out



two-axis measurement

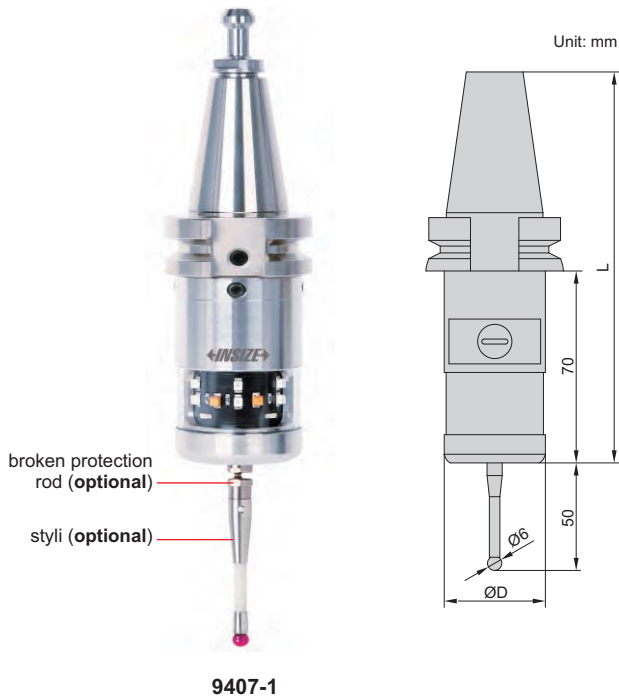


large size measurement

OPTICAL TRANSMISSION PROBES FOR CNC MACHINE TOOLS



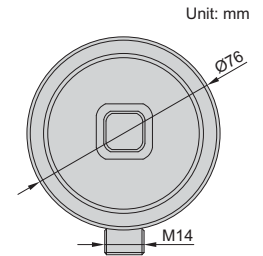
IP68
WATERPROOF



9407-1



9407-1A



Unit: mm

15

- On-machine measurement
- Multi-channel transmission between probes and receivers, for anti-interference
- Transmit three kinds of signals: trigger, contact and low battery voltage
- With spindle protection function
- Optical transmission range: 1m, 3m, 5m
- Automatic power off in 3 seconds, move styli to power on

OPTICAL PROBE SPECIFICATION

Code	9407-1	9407-2
Probe length (L)	140mm	180mm
Probe diameter (ØD)	40mm	46.5mm
Trigger accuracy of styli in any direction	1µm	
Protection stroke triggered by styli in all directions	X and Y axis stroke: ±12.5°, Z axis stroke: 5mm	
Trigger force of styli in all directions	X and Y axis: 0.9N, Z axis: 6N	
Applicable spindle	below BT40	over BT50
Dust/waterproof	IP68	
Power supply	2×LS14250 lithium battery	

RECEIVER SPECIFICATION

Code	9407-1A	9407-2A
Protection function	no	low battery voltage or probe transmitting signal all the time*
Applicable probe	code 9407-1	code 9407-2
Cable length	5m	
Dust/waterproof	IP68	

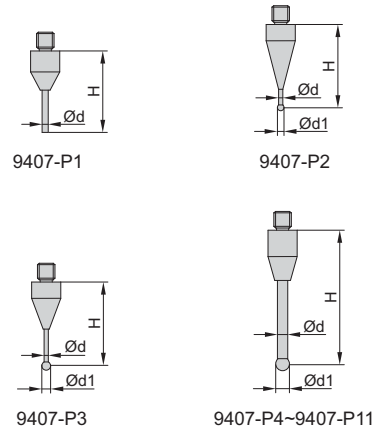
* When the battery voltage is low or the probe transmits signal all the time, the receiver will send a signal to the machine tool to stop working.

To be continued

Continued from previous page

STYLI (OPTIONAL) (mm)

Code	H	Ød	Ød1	Material of measuring face
9407-P1	20	1	—	carbide
9407-P2	19.5	0.7	1	ruby
9407-P3	19	1.4	2	ruby
9407-P4	20	0.7	1	ruby
9407-P5	20	1.5	2	ruby
9407-P6	20	2	3	ruby
9407-P7	20	2	4	ruby
9407-P8	50	3	4	ruby
9407-P9	50	3.8	5	ruby
9407-P10	50	4.5	6	ruby
9407-P11	75	3.8	5	ruby

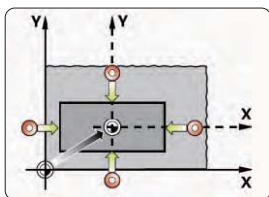


BROKEN PROTECTION ROD (OPTIONAL)

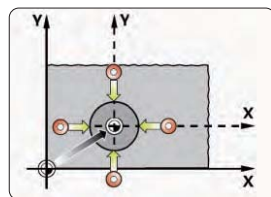
Code	H
9407-R1	12mm
9407-R2	22mm



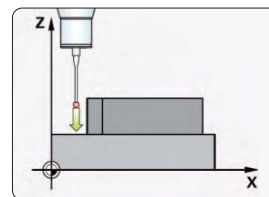
application



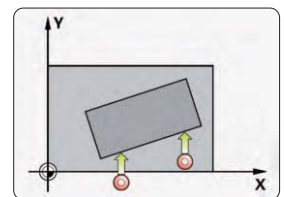
find center of rectangular boss



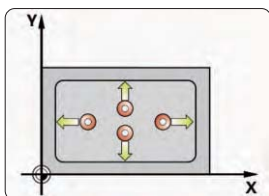
find center of the round boss



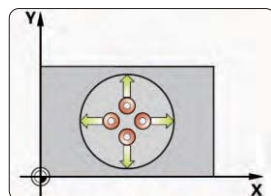
measure position of point on any axis



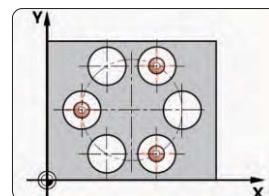
measure inclination of line



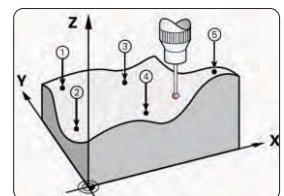
measure rectangular cavity



measure round cavity

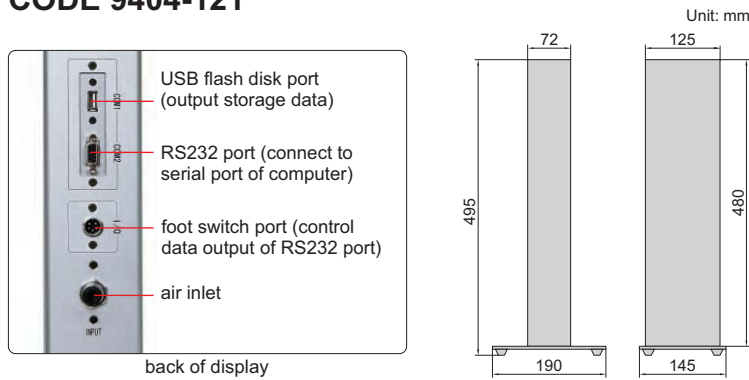


measure center of holes



measure freeform surfaces

AIR GAGE DISPLAY CODE 9404-121



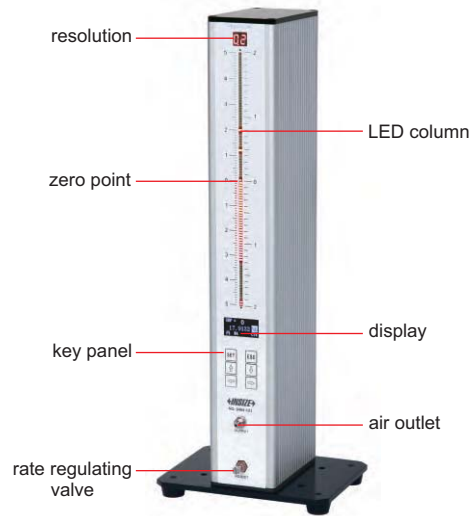
- Can store 10 measuring programs, and the program can be switched quickly
- Data storage function, support manual and automatic storing, 3000 groups data can be stored
- Insert USB flash disk to output storage data
- Automatically detect internal or external dimension measurement
- With foot switch for data transmission
- Automatic grouping function for workpiece sorting

SPECIFICATION

LED quantity	101 pcs		
LED color	red, orange, green		
LED height	254mm		
Indication range, resolution and accuracy	indication range	resolution	accuracy
	$\pm 5\mu\text{m}$	$0.1\mu\text{m}$	$0.2\mu\text{m}$
	$\pm 10\mu\text{m}$	$0.2\mu\text{m}$	$0.4\mu\text{m}$
	$\pm 25\mu\text{m}$	$0.5\mu\text{m}$	$1\mu\text{m}$
	$\pm 50\mu\text{m}$	$1\mu\text{m}$	$2\mu\text{m}$
Unit	mm, μm		
Measuring mode	dynamic measurement, Max, Min, Max-Min, (Max+Min)/2, (Max-Min)/2		
Air supply	dry and clean, 0.4~0.8MPa		
Data interface	RS232/USB flash disk		
Operation temperature	0~45°C		
Power supply	220V, 50/60Hz		
Dimension (L×W×H)	190×145×495mm		
Weight	4.25kg		

STANDARD DELIVERY

Main unit	1 pc
-----------	------



air filter (optional)



pressure regulating valve (optional)



RS232 cable (optional)



foot switch (optional)

OPTIONAL ACCESSORY

Air filter	9401-FILTER
Pressure regulating valve	9404-PRV
RS232 cable	9404-CABLE
Foot switch	9404-FS

AIR GAGES CODE 9401-PB

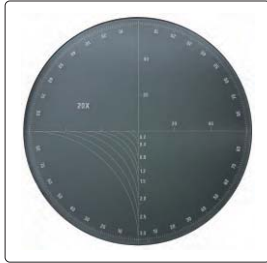
CUSTOM-MADE

<p>air plug gage and standard rings</p> <p>measure diameter of hole, range: $\text{Ø}4\sim 230\text{mm}$</p>	<p>air ring gage and standard plain plug gages</p> <p>measure diameter of shaft, range: $\text{Ø}4\sim 160\text{mm}$</p>	<p>air snap gage and standard column gages</p> <p>measure diameter of shaft, range: $\text{Ø}15\sim 160\text{mm}$</p>	<p>air taper gage and standard gages</p>
---	---	--	--

TOOL PRESETTER (PROJECTOR TYPE) CODE TLP-P340**



projection screen Ø120mm with scale
(protractor with 1° graduation, radius with 0.2,
0.4, 0.8, 1.2, 1.5, 2, 2.5, 3mm graduation)



BT50 spindle holder
spindle rotation hand wheel

X axis moving handle wheel

printer

Z axis moving button (motor drive)

foot-switch



standard rod (included)



BT50/BT40 converter (optional)



BT50/BT30 converter (optional)

▪ 99 data can be saved and printed

SPECIFICATION

Maximum tool diameter (X axis)		Ø300mm
Height measuring range (Z axis)		30~400mm
Accuracy	X axis	±6µm
	Z axis	±13µm
Resolution		0.5µm
Diameter of projection screen		Ø120mm
Lens	magnification	20X
	view filed	Ø6mm
Illumination		24V/20W
Spindle holder		BT50
Power supply		220V, 50/60HZ **
Dimension (L×W×H)		940×520×870mm
Weight		90kg

STANDARD DELIVERY

Main unit	1 pc
BT50 spindle holder	1 pc
Standard rod	1 pc
Foot-switch	1 pc
Anti-dust cover	1 pc

OPTIONAL ACCESSORY

BT50/BT30 converter	TLP-P340-C1
BT50/BT40 converter	TLP-P340-C2

** Add "-U" on code No. when power supply is 110V, 50/60Hz

PROFILE PROJECTORS



ISP-Z3015



edge detector

ISP-A1000E

digital readout of ISP-A1000E

- touch buttons
- USB data output to Excel and CAD
- show diagram

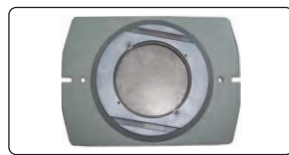


software CD (included, only for ISP-A1000E)

OPTIONAL ACCESSORY



lens



rotary table (glass plate diameter 100mm)



overlay chart (protractor with 1° graduation, radius with 1mm increment)



holder with clamp



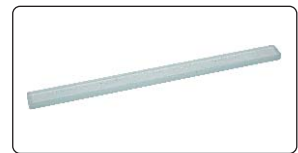
swivel center support



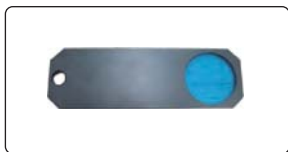
V-block with clamp



50mm reading scale (check magnification accuracy)



300mm calibration scale (check magnification accuracy together with 50mm reading scale or calibrate measuring accuracy)



blue filter



demo sample



printer (only for ISP-A1000E)

To be continued



Continued from previous page

SPECIFICATION

Code		ISP-Z3015	ISP-A1000E		
Edge detector		not included	included		
Lens	magnification	10X (included) 20X (optional)	50X (optional)	100X (optional)	
	view field	Ø30mm Ø15mm	Ø6mm	Ø3mm	
	working distance	77.7mm 44.3mm	38.4mm	25.3mm	
Max. workpiece height		90mm 90mm	90mm	90mm	
Magnification accuracy		±0.08%			
Image		erect image			
Projector screen		diameter: Ø300mm			
		rotation range: 0°~360°, resolution: 1" or 0.01°			
		reference lines: cross-hairs			
Stage	metal stage size	340×152mm			
	glass stage size	196×96mm			
	X-Y stage travel	range: 150×50mm			
		resolution: 0.5µm			
		accuracy: (4+L/25)µm L is the measuring length in mm			
Z (focus) travel range	90mm				
max. load capacity	4kg				
Illumination		contour illumination: 24V/150W halogen lamp, brightness is adjustable			
		surface illumination: 24V/150W halogen lamp			
Data processing unit	display	X-Y stage travel, screen rotation			
	output	RS232C	RS232C, USB (data output to Excel and CAD)		
	function	measure coordinate of point		measure coordinate of point	
		measure coordinate of line		measure coordinate of line	
measure center coordinate, radius of circle with three points			measure center coordinate, radius of circle with three points		
measure distance between two objects			measure distance between two objects		
measure angle with four points or two lines			measure angle with four points or two lines		
set origin of coordinate			coordinate transform		
coordinate transform			choose measurement object automatically according to the selective point and display the result		
set midpoint of coordinate					
advanced function	—	programming for batch measurements			
Power supply		110/220V, 50/60Hz			
Dimension (L×W×H)		550×770×1100mm			
Weight		135kg			

STANDARD DELIVERY

Main unit	1 pc
10X lens with half-reflection mirror and oblique illuminator mirror	1 pc
Overlay chart clip	4 pcs
Foot-switch	1 pc
Anti-dust cover	1 pc
Software (only for ISP-A1000E) and USB cable	1 pc

OPTIONAL ACCESSORY

20X lens with half-reflection mirror and oblique illuminator mirror	ISP-Z3015-LENS20X
50X lens with half-reflection mirror	ISP-Z3015-LENS50X
100X lens with half-reflection mirror	ISP-Z3015-LENS100X
Rotary table	ISP-Z3015-TABLE
Overlay chart	ISP-Z3015-CHART
Holder with clamp	ISP-Z3015-HOLDER

Swivel center support	ISP-Z3015-SUPPORT
V-block with clamp	ISP-Z3015-VBLOCK
50mm reading scale	ISP-Z3015-SCALE50
300mm calibration scale	ISP-Z3015-RULE
Blue filter	ISP-Z3015-FILTER
Demo sample	ISP-Z3015-DEMO
Printer (only for ISP-A1000E)	ISP-A1000-PRINTER

PROFILE PROJECTORS

THE STAGE DOESN'T
MOVE UP AND DOWN



ISP-AZ3020



ISP-A5000E



16

digital readout of ISP-A5000E

- Adjust the focus by ascending and descending the projector head, the stage doesn't move up and down
- Maximum workpiece weight 50kg

- touch buttons
- USB data output to Excel and CAD
- show diagram



software CD (included, only for ISP-A5000E)

OPTIONAL ACCESSORY



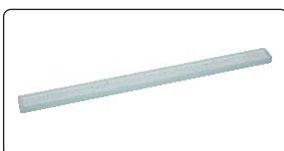
lens



overlay chart (protractor with 1° graduation, radius with 1mm increment)



50mm reading scale (check magnification accuracy)



300mm calibration scale (check magnification accuracy together with 50mm reading scale or calibrate measuring accuracy)



demo sample



printer (only for ISP-A5000E)

To be continued



Continued from previous page

SPECIFICATION

Code		ISP-AZ3020		ISP-A5000E		
Edge detector		not included		included		
Lens	magnification	10X (included)	20X (optional)	50X (optional)	100X (optional)	
	view field	Ø30mm	Ø15mm	Ø6mm	Ø3mm	
	working distance	77.7mm	44.3mm	38.4mm	25.3mm	
Max. workpiece height		100mm	100mm	100mm	100mm	
Magnification accuracy		±0.08%				
Image		erect image				
Projector screen		diameter: Ø300mm				
		rotation range: 0°~360°, resolution: 1' or 0.01°				
		reference lines: cross-hairs				
Stage	metal stage size	404×228mm				
	glass stage size	260×160mm				
	X-Y stage travel	range: 200×100mm				
		resolution: 0.5µm				
	Z (focus) travel range	accuracy: (3+L/75)µm L is the measuring length in mm				
max. load capacity	100mm					
Illumination		contour illumination: 24V/150W halogen lamp, brightness is adjustable				
		surface illumination: 24V/150W halogen lamp, brightness is adjustable				
Data processing unit	display	X-Y stage travel, screen rotation				
	output	RS232C		RS232C, USB (data output to Excel and CAD)		
	function	measure coordinate of point	measure coordinate of point		measure coordinate of point	
		measure coordinate of line	measure coordinate of line		measure coordinate of line	
measure center coordinate, radius of circle with three points		measure center coordinate, radius of circle with three points		measure center coordinate, radius of circle with three points		
measure distance between two objects		measure distance between two objects		measure distance between two objects		
measure angle with four points or two lines		measure angle with four points or two lines		measure angle with four points or two lines		
set origin of coordinate		set origin of coordinate		coordinate transform		
coordinate transform		coordinate transform		choose measurement object automatically according to the selective point and display the result		
set midpoint of coordinate		set midpoint of coordinate				
advanced function	—		programming for batch measurements			
Power supply		110/220V, 50/60Hz				
Dimension (L×W×H)		780×780×1100mm				
Weight		160kg				

16

STANDARD DELIVERY

Main unit	1 pc
10X lens with half-reflection mirror and oblique illuminator mirror	1 pc
Overlay chart clip	4 pcs
Foot-switch	1 pc
Anti-dust cover	1 pc
Software (only for ISP-A5000E) and USB cable	1 pc

OPTIONAL ACCESSORY

20X lens with half-reflection mirror and oblique illuminator mirror	ISP-A5000-LENS20X
50X lens with half-reflection mirror	ISP-A5000-LENS50X
100X lens with half-reflection mirror	ISP-A5000-LENS100X
Overlay chart	ISP-A5000-CHART

50mm reading scale	ISP-A5000-SCALE50
300mm calibration scale	ISP-A5000-RULE
Demo sample	ISP-A5000-DEMO
Printer (only for ISP-A5000E)	ISP-A5000-PRINTER

HORIZONTAL PROFILE PROJECTORS



ISP-W3020



ISP-A3000E



digital readout of ISP-A3000E

- touch buttons
- USB data output to Excel and CAD
- show diagram



software CD (included, only for ISP-A3000E)

OPTIONAL ACCESSORY



lens



overlay chart (protractor with 1° graduation, radius with 1mm increment)



50mm reading scale (check magnification accuracy)



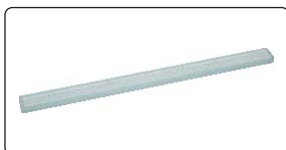
demo sample



V-block with clamp



rotary table



300mm calibration scale (check magnification accuracy together with 50mm reading scale or calibrate measuring accuracy)



vise



printer (only for ISP-A3000E)

To be continued

Continued from previous page

SPECIFICATION

Code		ISP-W3020	ISP-A3000E		
Edge detector		not included	included		
Lens	magnification	10X (included) 20X (optional)	50X (optional)	100X (optional)	
	view field	Ø30mm Ø15mm	Ø6mm	Ø3mm	
	working distance	77.7mm 44.3mm	38.4mm	25.3mm	
Magnification accuracy		±0.08%			
Projector screen		diameter: Ø300mm			
		rotation range: 0°~360°, resolution: 1' or 0.01°			
		reference lines: cross-hairs			
Stage	metal stage size	400×150mm			
	turning range	±15°			
	X-Z stage travel	range: 200×100mm			
		resolution: 0.5µm			
	Y (focus) travel range	accuracy: (4+L/25)µm L is the measuring length in mm			
max. load capacity	75mm				
Illumination		contour illumination: 24V/150W halogen lamp, brightness is adjustable			
		surface illumination: 12V/150W halogen lamp (with 2 fibers), position is adjustable			
Data processing unit	display	X-Z stage travel, screen rotation			
	output	RS232C	RS232C, USB (data output to Excel and CAD)		
	function		measure coordinate of point		measure coordinate of point
			measure coordinate of line		measure coordinate of line
		measure center coordinate, radius of circle with three points		measure center coordinate, radius of circle with three points	
		measure distance between two objects		measure distance between two objects	
		measure angle with four points or two lines		measure angle with four points or two lines	
		set origin of coordinate		coordinate transform	
		coordinate transform		choose measurement object automatically according to the selective point and display the result	
		set midpoint of coordinate			
advanced function	—	programming for batch measurements			
Power supply		110/220V, 50/60Hz			
Dimension (L×W×H)		1090×830×1010mm			
Weight		160kg			

STANDARD DELIVERY

Main unit	1 pc
10X lens	1 pc
Overlay chart clip	4 pcs
Foot-switch	1 pc
Anti-dust cover	1 pc
Software (only for ISP-A3000E) and USB cable	1 pc

OPTIONAL ACCESSORY

20X lens	ISP-A3000-LENS20X
50X lens	ISP-A3000-LENS50X
100X lens	ISP-A3000-LENS100X
Overlay chart	ISP-A3000-CHART
50mm reading scale	ISP-A3000-SCALE50
300mm calibration scale	ISP-A3000-RULE

Demo sample	ISP-A3000-DEMO
V-block with clamp	ISP-A1000-VBLOCK
Rotary table	ISP-A3000-RTABLE
Vice	ISP-A3000-VICE
Printer (only for ISP-A3000E)	ISP-A3000-PRINTER

HORIZONTAL PROFILE PROJECTORS



ISP-W4025



ISP-A7000E



digital readout of ISP-A7000E

- touch buttons
- USB data output to Excel and CAD
- show diagram



software CD
(included, only for
ISP-A7000E)

OPTIONAL ACCESSORY



lens



V-block with clamp



rotary table



demo sample (need rotary table)



vise



printer (only for ISP-A7000E)



300mm calibration scale (check magnification accuracy together with 50mm reading scale or calibrate measuring accuracy)



Ø300mm overlay chart (protractor with 1° graduation, radius with 1mm increment)



50mm reading scale (check magnification accuracy)

To be continued

Continued from previous page

SPECIFICATION

Code		ISP-W4025			ISP-A7000E		
Edge detector		not included			included		
Lens	magnification	5X (optional)	10X (standard)	20X (optional)	50X (optional)	100X (optional)	
	view field	Ø80mm	Ø40mm	Ø20mm	Ø8mm	Ø4mm	
	working distance	93.7mm	103.9mm	95.1mm	65.7mm	35mm	
Magnification accuracy		±0.08%					
Image		erect image					
Projector screen		diameter: Ø400mm					
		rotation range: 0°~360°, resolution: 1' or 0.01°					
		reference lines: cross-hairs					
Stage	metal stage size	450×200mm					
	turning range	±15°					
	X-Z stage travel	range: 250×150mm					
		resolution: 0.5µm					
	Y (focus) travel range	accuracy: (4+L/25)µm L is the measuring length in mm					
max. load capacity	100mm						
Illumination		contour illumination: 24V/150W halogen lamp, brightness is adjustable					
		surface illumination: 12V/150W halogen lamp (with 2 fibers), position is adjustable					
Data processing unit	display	X-Z stage travel, screen rotation					
	output	RS232C			RS232C, USB (data output to Excel and CAD)		
	function	measure coordinate of point	measure coordinate of point			measure coordinate of point	
		measure coordinate of line	measure coordinate of line			measure coordinate of line	
		measure center coordinate, radius of circle with three points	measure center coordinate, radius of circle with three points			measure center coordinate, radius of circle with three points	
measure distance between two objects		measure distance between two objects			measure distance between two objects		
measure angle with four points or two lines		measure angle with four points or two lines			measure angle with four points or two lines		
set origin of coordinate		set origin of coordinate			coordinate transform		
coordinate transform		coordinate transform			choose measurement object automatically according to the selective point and display the result		
set midpoint of coordinate	set midpoint of coordinate						
advanced function		—			programming for batch measurements		
Power supply		110/220V, 50/60Hz					
Dimension (L×W×H)		1215×646×1210mm					
Weight		240kg					

STANDARD DELIVERY

Main unit	1 pc
10X lens	1 pc
Overlay chart clip	4 pcs
Foot-switch	1 pc
Anti-dust cover	1 pc
Software (only for ISP-A7000E) and USB cable	1 pc

OPTIONAL ACCESSORY

5X lens	ISP-W4025-LENS5X
20X lens	ISP-W4025-LENS20X
50X lens	ISP-W4025-LENS50X
100X lens	ISP-W4025-LENS100X
Ø300mm overlay chart	ISP-A3000-CHART
50mm reading scale	ISP-A3000-SCALE50

300mm calibration scale	ISP-A3000-RULE
Demo sample	ISP-A3000-DEMO
V-block with clamp	ISP-A1000-VBLOCK
Rotary table	ISP-A3000-RTABLE
Vice	ISP-A3000-VISE
Printer (only for ISP-A7000E)	ISP-A3000-PRINTER

PROFILE PROJECTORS



edge detector (for ISP-A6000E)

digital readout

- touch buttons
- USB data output to Excel and CAD
- show diagram



software CD (included)

ISP-A6000 (without edge detector)

OPTIONAL ACCESSORY



lens



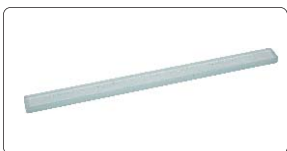
rotary table
(glass plate diameter 100mm)



holder with clamp



swivel center support



300mm calibration scale (check magnification accuracy together with 50mm reading scale or calibrate measuring accuracy)



50mm reading scale
(check magnification accuracy)



demo sample










printer

To be continued

Continued from previous page

SPECIFICATION

Code		ISP-A6000	ISP-A6000E			
Edge detector		not included	included			
Projector screen		diameter: Ø600mm				
		rotation range: 0°~360°, resolution: 1' or 0.01°				
		reference lines: cross-hairs				
Lens	magnification	5X (optional)	10X (included)	20X (optional)	50X (optional)	100X (optional)
	view field	Ø120mm	Ø60mm	Ø30mm	Ø12mm	Ø6mm
	working distance	242.8mm	143.2mm	85.5mm	92mm	48.5mm
Magnification accuracy		±0.08%				
Image		erect image				
Stage	metal stage size	404×265mm				
	glass stage size	207×170mm				
	X-Y stage travel	range: 200×100mm				
		resolution: 0.5µm				
	Z (focus) travel range	50mm				
max. load capacity	5kg					
Illumination		contour illumination: 24V/150W halogen lamp, brightness is adjustable				
		surface illumination: 12V/150W halogen lamp (with 2 fibers), position is adjustable				
Data processing unit	display	X-Y stage travel, screen rotation				
	output	RS232C, USB (data output to Excel and CAD)				
	function		measure coordinate of point			
			measure coordinate of line			
		measure center coordinate, radius of circle with three points				
		measure distance between two objects				
		measure angle with four points or two lines				
		coordinate transform				
advanced function		choose measurement object automatically according to the selective point and display the result				
Power supply		110/220V, 50/60Hz				
Dimension (L×W×H)		1200×1140×1940mm				
Weight		360kg				

STANDARD DELIVERY

Main unit	1 pc
10X lens	1 pc
Foot-switch	1 pc
Software (only for ISP-A6000E) and USB cable	1 pc
Overlay chart clip	4 pcs
Anti-dust cover	1 pc

OPTIONAL ACCESSORY

5X lens	ISP-A6000-LENS5X
20X lens	ISP-A6000-LENS20X
50X lens	ISP-A6000-LENS50X
100X lens	ISP-A6000-LENS100X
Holder with clamp	ISP-A6000-HOLDER
Swivel center support	ISP-A6000-SUPPORT

300mm calibration scale	ISP-A6000-RULE
50mm reading scale	ISP-A6000-SCALE50
Rotary table	ISP-A6000-TABLE
Demo sample	ISP-A6000-DEMO
Printer	ISP-A6000-PRINTER

VISION MEASURING SYSTEMS

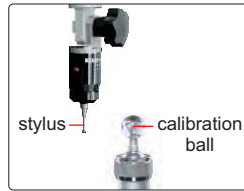
**INSPECTION
CERTIFICATE**



lens with coaxial light
(optional, must be
installed in factory)

STANDARD DELIVERY

Main unit	1 pc
Computer	1 pc
Calibration glass chart	1 pc
Clay	1 pc
Foot switch	1 pc
Anti-dust cover	1 pc



probe (optional), includes
Ø2mm and Ø3mm styli,
Ø25mm calibration ball,
measuring accuracy is 10µm



ISD-V250A

computer is included

SPECIFICATION

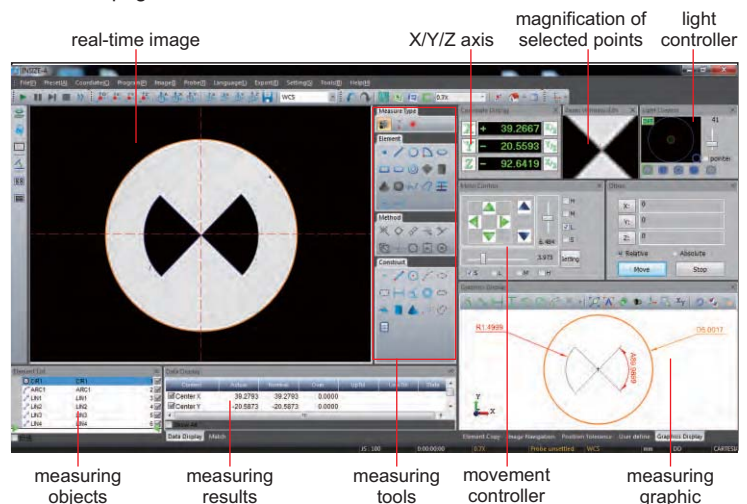
Code	ISD-V150A	ISD-V250A	ISD-V300A	ISD-V400A
Measuring range (X×Y×Z)	150×100×200mm	250×150×200mm	300×200×200mm	400×300×200mm
Stage size	354×228mm	450×280mm	500×330mm	606×466mm
Stage glass size	210×160mm	306×196mm	350×250mm	450×350mm
Resolution of X/Y/Z axis	0.5µm			
Accuracy of X/Y axis	≤(3.5+L/100)µm (L is the measuring length in mm)			
Repeatability of X/Y axis	2µm			
Objective	0.7X~4.5X (zoom)			
Working distance	92mm			
Magnification	33X~195X (on 19" monitor)			
Camera	1/3" color CCD, 0.3M pixel			
Illumination	surface and contour with adjustable LED			
Max. height of workpiece	160mm			
Max. weight of workpiece	20kg			
Operation system	Windows 7/8/10			
Drive method	manual			
Power supply	110/220V, 50/60Hz			
Dimension (L×W×H)	560×540×850mm	760×600×900mm	760×600×900mm	970×670×940mm
Weight	100kg	120kg	140kg	240kg

OPTIONAL ACCESSORY

0.5X auxiliary objective	Code: ISD-V-OB05X Working distance: 175mm Magnification: 16.5~97.5X (on 19" monitor)
2X auxiliary objective	Code: ISD-V-OB2X Working distance: 36mm Magnification: 66~390X (on 19" monitor)
Probe	Code: ISD-V-PROBE Includes Ø2mm and Ø3mm styli, Ø25mm calibration ball
Vision measuring system with coaxial light lens (with computer)	Code: ISD-V150ACL, ISD-V250ACL, ISD-V300ACL, ISD-V400ACL
Office software	Code: 7313-OFFICE

SOFTWARE (INCLUDED)

- Refer to page 311~312 for details



HIGH-DEFINITION VISION MEASURING SYSTEMS



lens with coaxial light (**optional**, must be installed in factory)

- High-definition image
- Large view field
- Electronic magnification feedback lens: when the objective lens magnification is changed manually, the software automatically selects the corresponding pre-calibration data and calibration is not needed

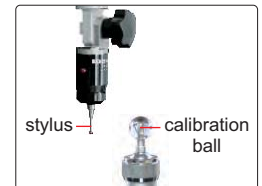


ISD-H210

computer is included

SPECIFICATION

Code	ISD-H210	ISD-H320	ISD-H430
Measuring range (X×Y×Z)	200×100×150mm	300×200×150mm	400×300×150mm
Stage size	404×228mm	500×330mm	606×466mm
Stage glass size	260×160mm	350×250mm	450×350mm
Resolution of X/Y/Z axis	0.5μm		
Accuracy of X/Y axis	≤(3.5+L/100)μm (L is the measuring length in mm)		
Repeatability of X/Y axis	2μm		
Objective	0.58X~7.5X (zoom)		
View field (diagonal length)	1.4mm~14mm		
Working distance	82mm		
Magnification	27.4X~351X (on 24" monitor)		
Camera	Giga-bit network camera		
Illumination	surface and contour with adjustable LED		
Max. height of workpiece	170mm		
Max. weight of workpiece	20kg		
Operation system	Windows 7/8/10		
Drive method	manual		
Power supply	110~240V, 50/60Hz		
Dimension (L×W×H)	540×560×850mm	760×600×900mm	970×670×940mm
Weight	110kg	140kg	240kg



probe (**optional**), includes Ø2mm and Ø3mm styli, Ø25mm calibration ball, measuring accuracy is 10μm

STANDARD DELIVERY

Main unit	1 pc
Computer	1 pc
Calibration glass chart	1 pc
Clay	1 pc
Foot switch	1 pc
Anti-dust cover	1 pc

OPTIONAL ACCESSORY

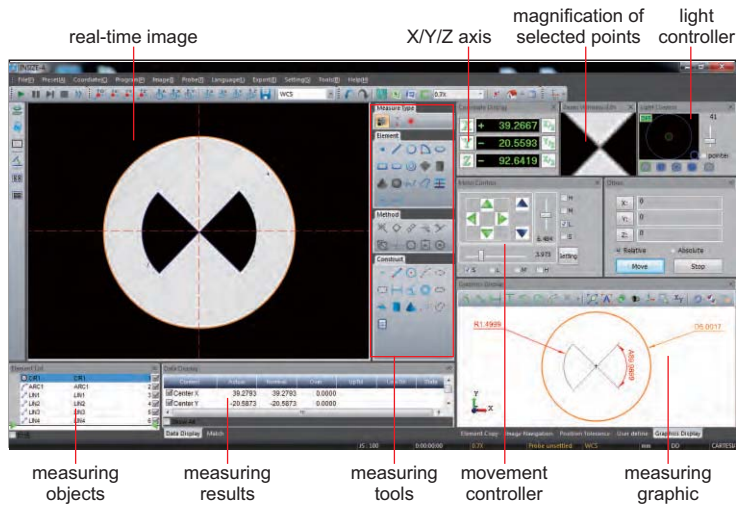
0.5X auxiliary objective	Code: ISD-H-OB05X Working distance: 155mm Magnification: 13.7~175.5X (on 24" monitor)
2X auxiliary objective	Code: ISD-H-OB2X Working distance: 34.5mm Magnification: 54.8~702X (on 24" monitor)
Probe	Code: ISD-V-PROBE Includes Ø2mm and Ø3mm styli, Ø25mm calibration ball
Vision measuring system with coaxial light lens	Code: ISD-H210CL, ISD-H320CL, ISD-H430CL
Office software	Code: 7313-OFFICE

To be continued

Continued from previous page

SOFTWARE (INCLUDED)

- Refer to page 311~312 for details



CNC VISION MEASURING SYSTEMS



MOTORIZED ZOOM LENS IS OPTIONAL

16



software CD (included)



VIDEO

- Automatic edge-detection, focus, measuring, contour scanning, calibration, etc.
- Servo motors for X, Y, Z axis
- SPC function for large quantity measurement
- Measuring software is included (page 311~312)



lens with coaxial light (included)

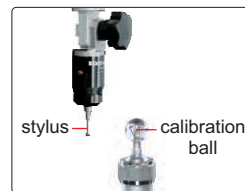


programmable segmented ring light (included)



STANDARD DELIVERY

Main unit	1 pc
Video card with dongle	1 pc
Software disc	1 pc
Computer	1 pc
19.5" Display	1 pc
Len with coaxial light	1 pc
Controller	1 pc
Calibration glass chart	1 pc
Laser positioner	1 pc
Clay	1 pc
Anti-dust cover	1 pc



probe (optional), includes Ø2mm and Ø3mm styli, Ø25mm calibration ball, measuring accuracy is 10µm

To be continued

Continued from previous page

SPECIFICATION

Code	ISD-V220CNCA**	ISD-V270CNCA**	ISD-V370CNCA**
Measuring range (X×Y×Z)	220×120×150mm	270×170×150mm	370×270×150mm
Stage size	450×280mm	500×330mm	606×466mm
Glass stage size	306×196mm	350×250mm	450×350mm
Resolution of X/Y/Z axis	0.5μm		
Accuracy of X/Y axis	≤(2.5+L/100)μm (L is the measuring length in mm)		≤(3.5+L/100)μm (L is the measuring length in mm)
Repeatability of X/Y axis	2μm		
Objective	0.7X~4.5X (zoom)		
Working distance	92mm		
Magnification	20X~128X (on 19.5" monitor)		
Camera	1/2" color CCD, 0.4M pixel		
Illumination	surface	coaxial light, programmable segmented ring light	
	contour	adjustable LED light	
View field (diagonal length)	1.7~11.1mm		
Max. height of workpiece	160mm		
Max. weight of workpiece	30kg		
Operation system	Windows 7/8/10		
Drive method	Automatic		
Power supply	220V, 50/60Hz**		
Dimension (L×W×H)	760×600×900mm	760×600×900mm	970×670×940mm
Weight	146kg	168kg	266kg

** Add "-U" on code No. when power supply is 110V, 50/60Hz

OPTIONAL ACCESSORY

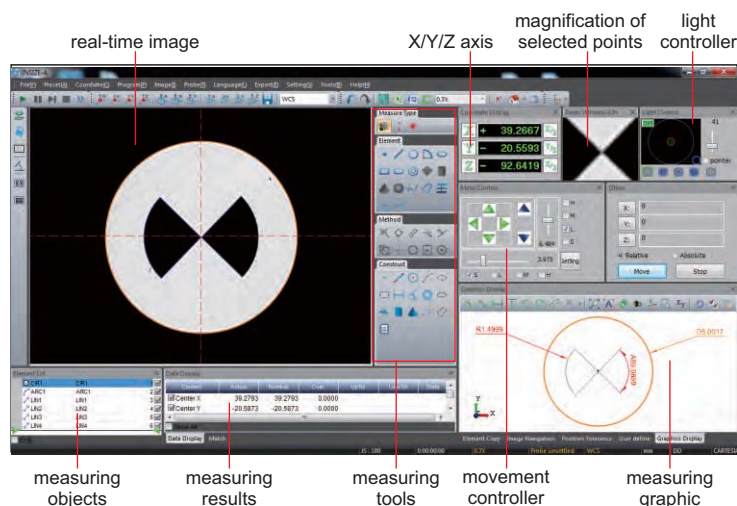
0.5X auxiliary objective	Code: ISD-V-OB05X Working distance: 175mm Magnification: 10~64X (on 19.5" monitor)
2X auxiliary objective	Code: ISD-V-OB2X Working distance: 36mm Magnification: 40~256X (on 19.5" monitor)
Probe	Code: ISD-V-PROBE Includes Ø2mm and Ø3mm styli, Ø25mm calibration ball
Office software	Code: 7313-OFFICE
Desk	Code: ISD-V-DESK

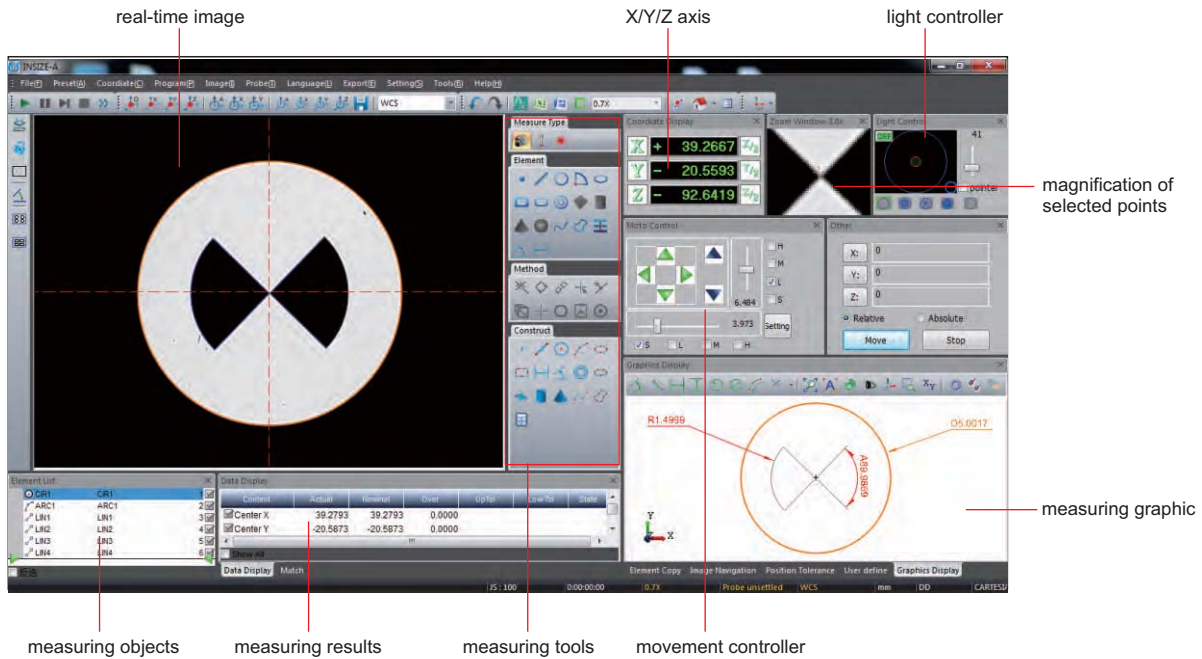
desk (optional)



SOFTWARE (INCLUDED)

- Refer to page 311~312 for details

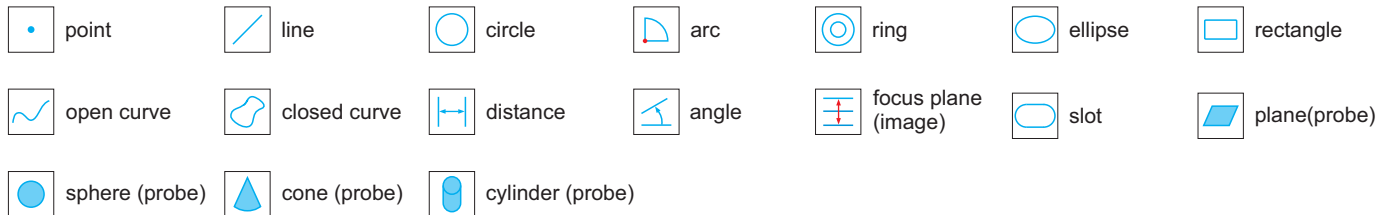




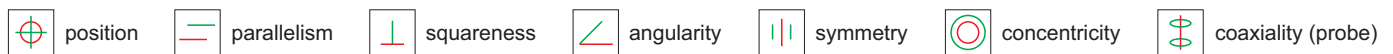
16

- Operation system: Windows 7/10
- Language: English
- Control features: assistant focus (manual machines), auto focus (CNC machines), auxiliary light control, motion controlled by mouse (CNC machines), auto zoom lens (CNC machines)
- Image measuring methods: intelligent automatic edge detect, select points of an area, select points from multiple parts, select points via mouse, select adjacent points, select points via cross line, magnify to select points, comparatively select points, select points via probe, edge point, contour point
- Constructable elements: point, line, circle, arc, ellipse, rectangle, distance, angle, ring, slot, plane, cone, open curve, closed curve
- Support fixture (CNC machines), scanning, image navigation, user define, pixel calibration
- Measuring by image and probe, image and probe can be synchronized
- Measuring data can export to Excel, Word, SPC, measuring elements can export to dxf

▪ Dimension measuring tools:



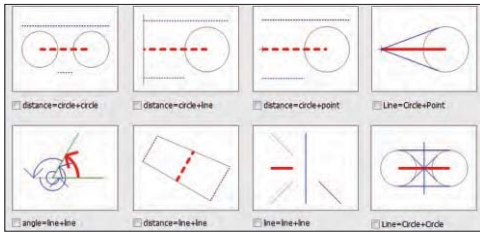
▪ Geometric measuring tools:



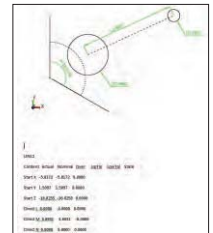
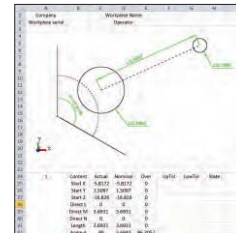
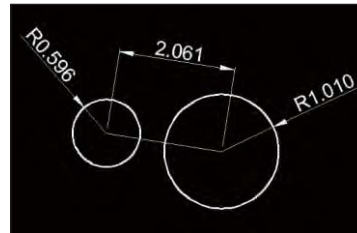
To be continued

Continued from previous page

Measuring and element construct methods:



Export to CAD, EXCEL, WORD



CAD

EXCEL

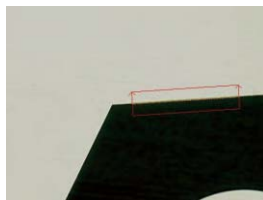
WORD

Edge-detection:

point tool



box tool



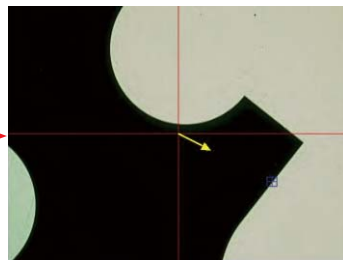
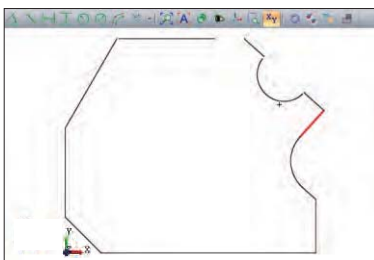
circle tool



Profile scanning:

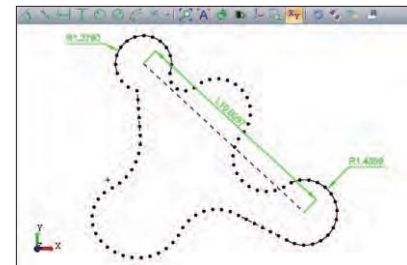


CAD measuring:

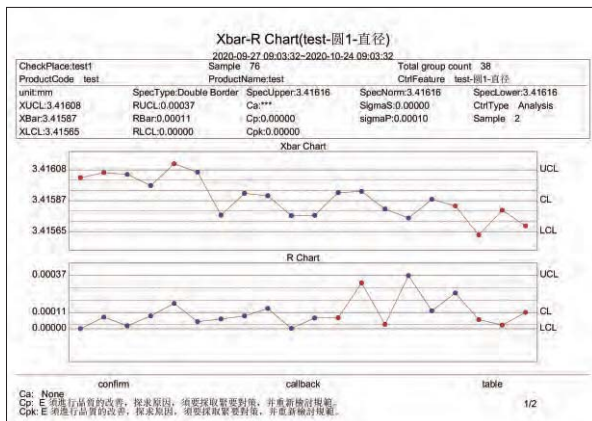


import CAD drawing, set the datum, establish coordinate system, then the software will automatically measure

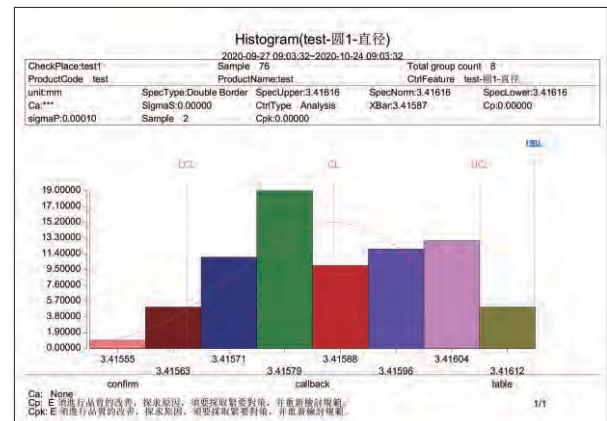
Contour scanning:



SPC analysis, import the measuring data to SPC module, generate Xbar-R chart, Xbar-S chart, Mid-R chart, X-Rs chart, Histogram, Sigma A and Sigma S chart, Cpk process chart, Process state analyse chart, Single process advice analyse chart



Xbar-R chart

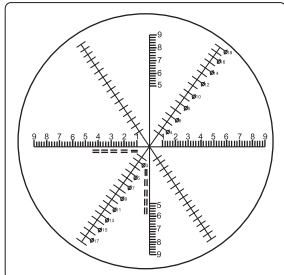


Histogram

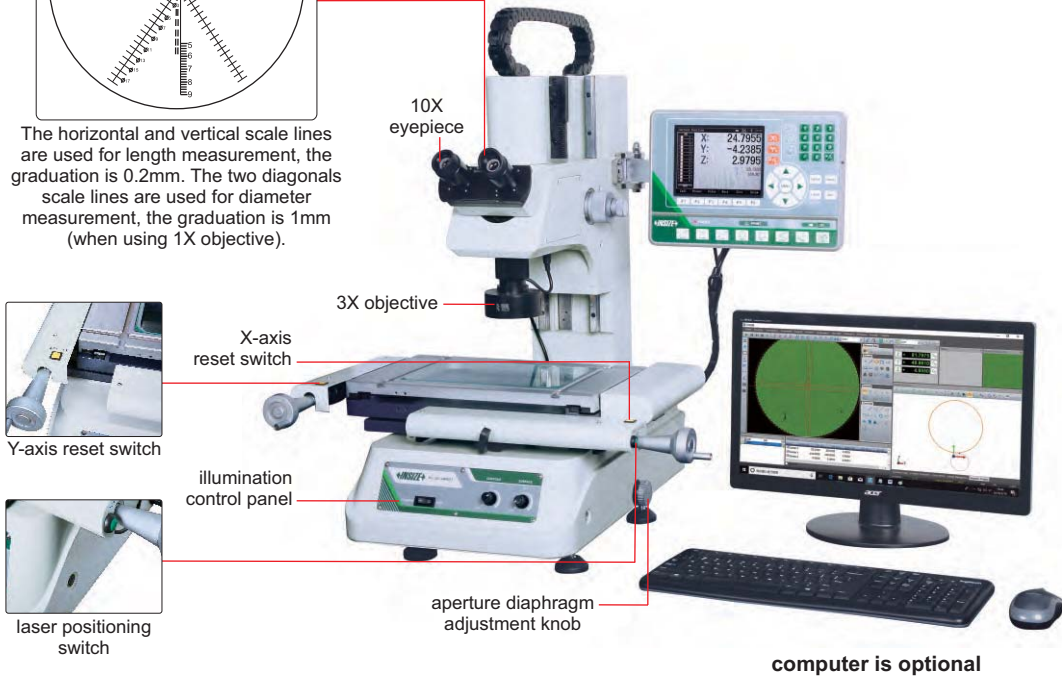
TOOLMAKER MICROSCOPES



10X dividing eyepiece



The horizontal and vertical scale lines are used for length measurement, the graduation is 0.2mm. The two diagonals scale lines are used for diameter measurement, the graduation is 1mm (when using 1X objective).



computer is optional

ISD-VMM215

17

SPECIFICATION

Code	binocular	ISD-VMM205	ISD-VMM215	ISD-VMM225	ISD-VMM235
	monocular	ISD-VMM205D	ISD-VMM215D	ISD-VMM225D	ISD-VMM235D
X/Y axis travel		150×100mm	200×100mm	250×150mm	300×200mm
Z axis travel		150mm	150mm	200mm	200mm
Metal stage size		354×228mm	404×228mm	450×280mm	500×330mm
Glass stage size		210×160mm	260×160mm	306×196mm	350×250mm
Resolution of X/Y/Z axis		0.5μm			
Accuracy of X/Y axis		≤(3.5+L/100)μm (L is the measuring length in mm)			
Repeatability		2μm			
Camera		1/3" color CCD, 0.3M pixel			
Optical magnification		30X (with 3X objective)			
Image magnification		114X (on 19" monitor)			
Illumination		surface and contour with adjustable LED			
Max. weight of workpiece		25kg			
Power supply		100V~240V, 50/60Hz			
Operating system		Windows 7/8/10			
Drive method		manual			
Dimension (L×W×H)		540×667×850mm	540×667×850mm	800×675×920mm	800×675×920mm
Weight		100kg	110kg	135kg	140kg

To be continued

Continued from previous page

DATA PROCESSING UNIT

Output	RS232
Function	Simple measuring tools
	Measure coordinate of points
	Measure lines
	Measure center coordinate, radius of circle with three points
	Measure distances between two objects
	Measure angles
	Set origin of coordinate
	Skew and calibrate the workpiece
	Measure rectangle (including length, width, perimeter and center coordinate)
	Measure thread (including thread diameter, screw pitch, screw angle)
Measure slot (including center coordinate, length, width)	

STANDARD DELIVERY

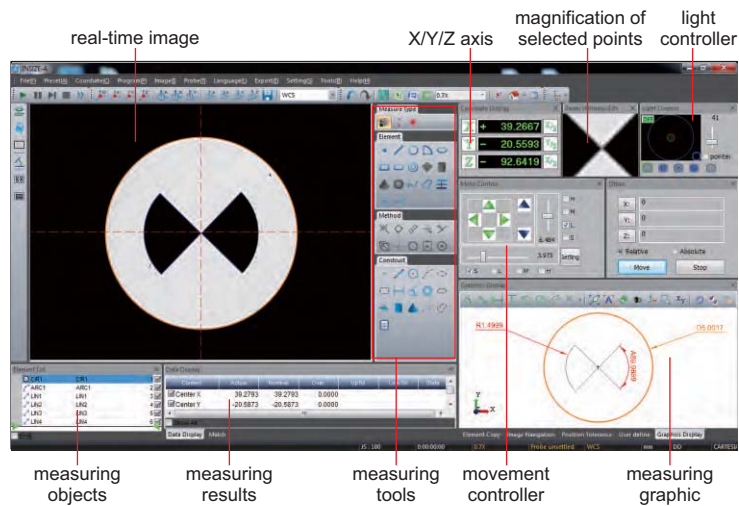
Main unit	1 pc
Video card with dongle	1 pc
Software disc	1 pc
Calibration glass chart	1 pc
Demo sample	1 pc
Foot switch	1 pc
3X objective	1 pc

OPTIONAL ACCESSORY

1X objective	ISD-VMM-LENS1X
5X objective	ISD-VMM-LENS5X
10X objective	ISD-VMM-LENS10X
Printer	ISD-VMM-PRINTER
Toolmaker microscopes (with computer)	Code: ISD-VMM205A (binocular) ISD-VMM215A (binocular) ISD-VMM225A (binocular) ISD-VMM235A (binocular)
	Code: ISD-VMM205DA (monocular) ISD-VMM215DA (monocular) ISD-VMM225DA (monocular) ISD-VMM235DA (monocular)

SOFTWARE (INCLUDED)

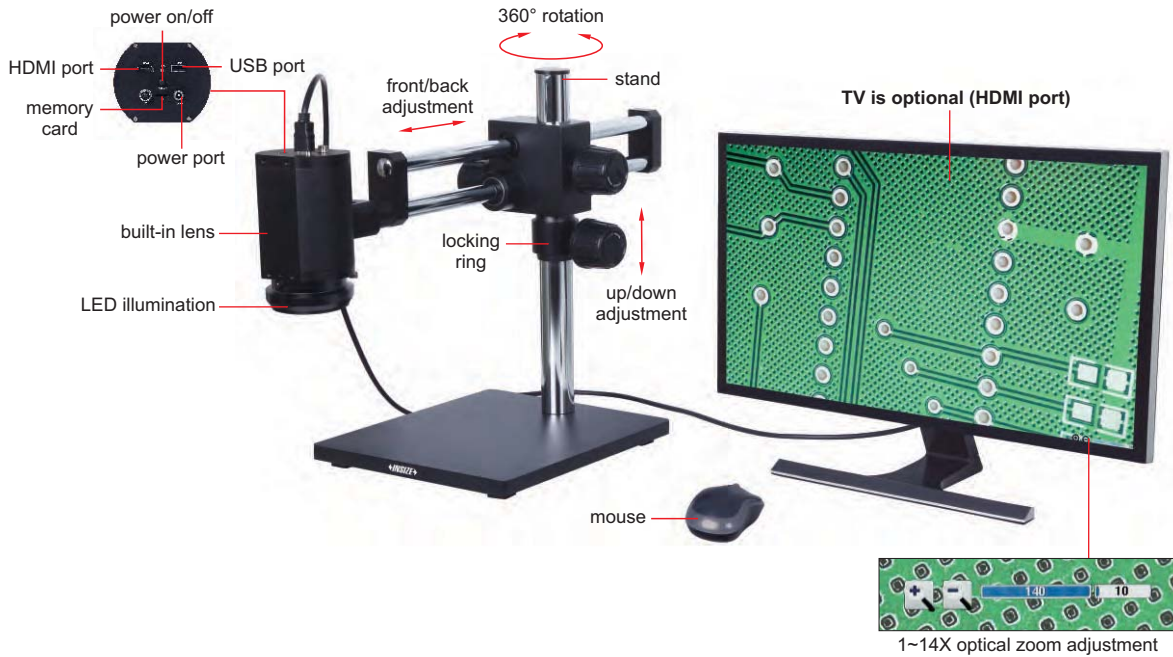
- Refer to page 311~312 for details



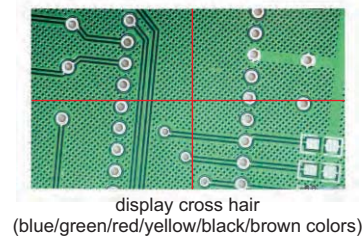
AUTO FOCUS DIGITAL MICROSCOPE CODE 5302-AF105

AUTO FOCUS

TAKE PICTURES
AND VIDEOS



- 1080P high-definition image
- Auto focus camera
- Take pictures and videos, saved to memory card
- Connected to TV by HDMI port
- Automatic exposure and white balance
- Brightness, contrast ratio, gain are adjustable
- Display cross hair (blue/green/red/yellow/black/brown colors)



SPECIFICATION

Magnification	1.8X~27.5X (on 28" TV)
Sensor	1/2.8" CMOS
Pixel	2M
Resolution	1920×1080
Frame rate	60fps
Auto focus distance	100mm~∞
Output	HDMI
Power supply	power adapter
Dimension (L×W×H)	500×280×410mm
Weight	17kg

STANDARD DELIVERY

Main unit (with stand)	1 pc
LED illumination	1 pc
8G memory card and holder	1 pc
Mouse	1 pc
HDMI cable (for TV)	1 pc
Power adapter	2 pcs

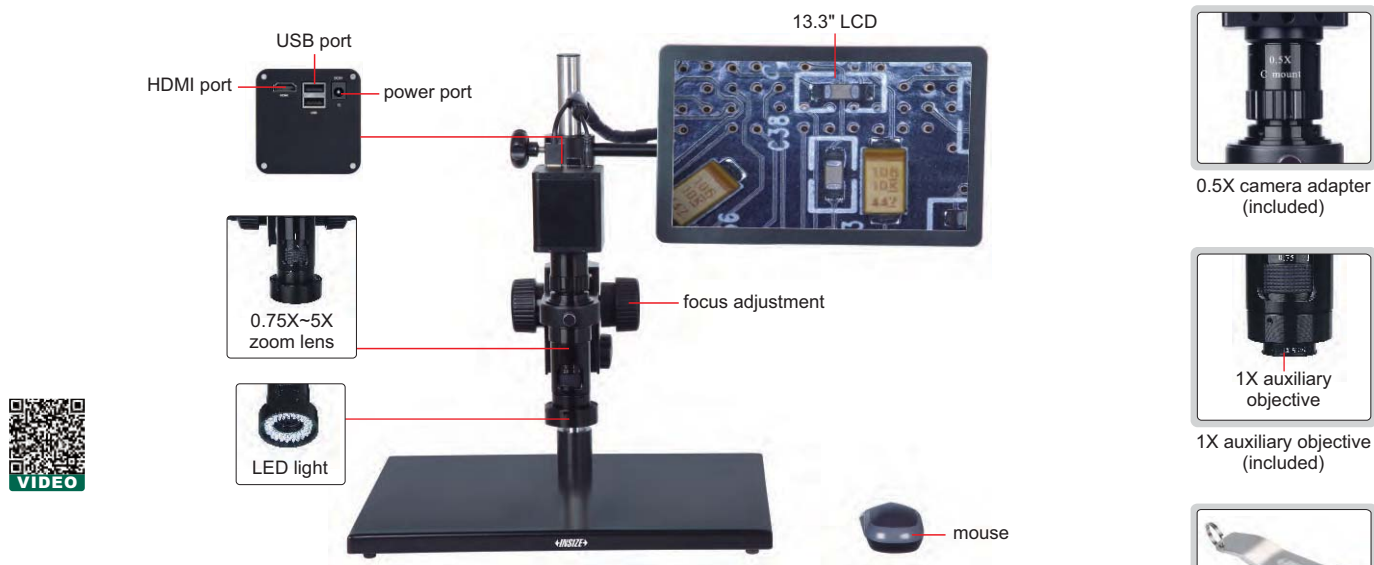
FOCUS DISTANCE, MAGNIFICATION AND VIEW FIELD (MANUAL FOCUS MODE)

Focus distance	Adjustable magnification (on 28" TV)	View field
100mm	4.5~27.5X	24×14~161×90mm
150mm	3~21X	30×17~240×128mm
200mm	2.3~17.5X	38×20~305×176mm
250mm	2~15X	42×24~320×210mm
270mm	1.8~14.4X	43×25~378×240mm

AUTO FOCUS

TAKE PICTURES AND VIDEOS

AUTO FOCUS DIGITAL MICROSCOPE (WITH DISPLAY) CODE 5303-AF103



0.5X camera adapter (included)



1X auxiliary objective (included)



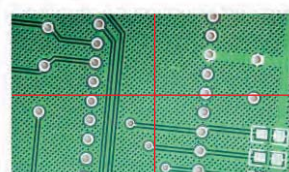
16G USB flash disk (included)



2X auxiliary objective (optional)



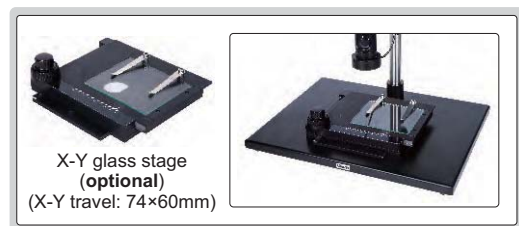
1X camera adapter (optional)



display cross hair (blue/green/red/yellow/black/brown colors)



- 1080P high-definition image
- Auto focus camera
- Take pictures and videos, saved to USB flash disk
- Picture review, picture compare
- Automatic exposure and white balance
- Brightness, contrast ratio, gain are adjustable
- Display cross hair (blue/green/red/yellow/black/brown colors)



SPECIFICATION

Magnification	20X~123X
Sensor	1/2.8" CMOS
Pixel	2M
Resolution	1920×1080
Frame rate	60fps
Output	HDMI
Power supply	power adapter
Dimension (L×W×H)	570×300×430mm
Weight	6.5kg

STANDARD DELIVERY

Main unit	1 pc
0.5X camera adapter	1 pc
1X auxiliary objective	1 pc
16G USB flash disk	1 pc
White/black plate	1 pc
Mouse	1 pc
HDMI cable	1 pc
Power adpter	2 pcs

MAGNIFICATION, FOCUS DISTANCE AND VIEW FIELD

Auxiliary objective	Specification	Camera adapter	
		0.5X (included)	1X (optional)
1X (included)	Magnification	20~123X	40~246X
	Focus distance	48~84mm	48~84mm
	View field	13×7~2.2×1mm	6.3×3.5~1.1×0.5mm
2X (optional)	Magnification	40~246X	80~492X
	Focus distance	24~42mm	24~42mm
	View field	6.5×3.5~1.1×0.5mm	3.3×1.8~0.6×0.3mm

AUTO FOCUS DISTANCE

Zoom objective scale	0.75X	1X	1.5X	2X	2.5X
Auto focus distance	48~84mm	50~78mm	55~73mm	62~71mm	65~70mm

Zoom objective scale	3X	3.5X	4X	4.5X	5X
Auto focus distance	66~70mm	67~70mm	68~70mm	68~70mm	68~70mm

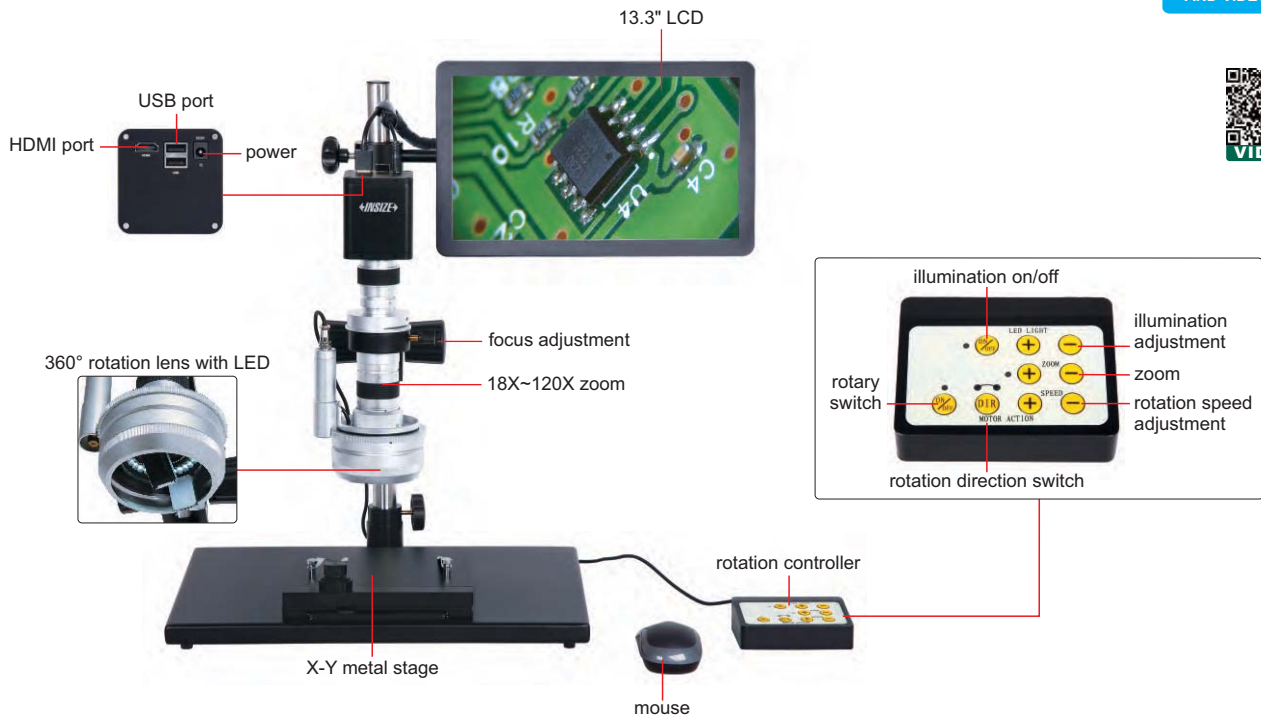
OPTIONAL ACCESSORY

1X camera adapter	ISM-DL-CA1X
2X auxiliary objective	ISM-DL-OB2X
X-Y glass stage (travel: 74×60mm)	ISM-DL-STAGE
X-Y metal stage	ISM-DL-STAGE1
LED light	page 329~330
Auxiliary objective	page 331

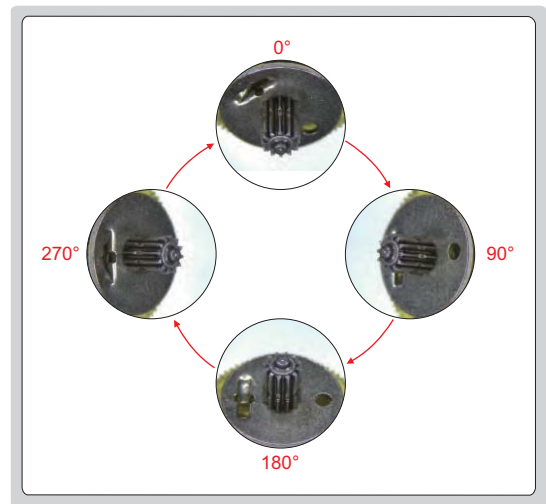
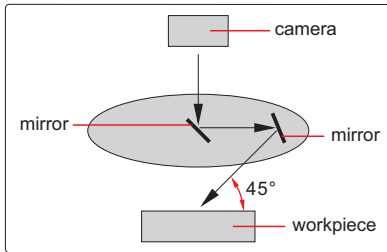
3D MOTORIZED ROTATION MICROSCOPE (WITH DISPLAY) CODE 5301-D400

SUITABLE TO CHECK CONVEX OBJECTS AND WALL OF HOLE

TAKE PICTURES AND VIDEOS



working principle



360° rotation observation

17

- 1080P high-definition 3D image
- Take pictures and videos, save to USB flash disk
- Automatic white balance and exposure
- Brightness, contrast ratio and gain are adjustable

SPECIFICATION

Magnification	18X~120X
View field	2.4×1.5mm~16×9mm
Focus distance	20mm
View angle	45°
Sensor	1/2.8" CMOS
Pixel	2M
Resolution	1920×1080
Frame rate	60fps
Output	HDMI
Rotation speed	2~5RPM
Power supply	110/220V, 50/60Hz
Dimension (L×W×H)	570×300×430mm
Weight	10kg

STANDARD DELIVERY

Main unit	1 pc
Rotation controller	1 pc
X-Y metal stage	1 pc
16G USB flash disk	1 pc
White/black plate	1 pc
Mouse	1 pc
Power adapter	2 pcs

ATTENTION: PLEASE MAKE CONFOCAL ADJUSTMENT AFTER CHANGING CAMERA ADAPTERS OR AUXILIARY OBJECTIVES

BUILT-IN SOFTWARE WITHOUT COMPUTER

MEASUREMENT

TAKE PICTURES



0.5X camera adapter (included)



1X auxiliary objective (included)



calibration plate (included)



16G USB flash disk (included)



1X camera adapter (optional)



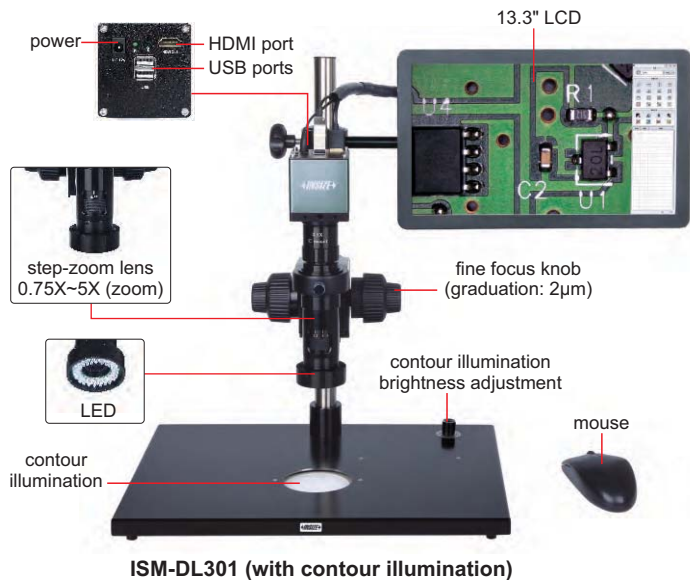
2X auxiliary objective (optional)

- 1080P high-definition image
- Built-in software without computer, operated by mouse
- Take pictures, save to USB flash disk
- Measurement results can be sent to Excel
- Automatic white balance and exposure
- Brightness, contrast ratio, gain are adjustable

DIGITAL MEASURING MICROSCOPES (WITH DISPLAY)



ISM-DL300 (without contour illumination)



ISM-DL301 (with contour illumination)

SPECIFICATION

Code	ISM-DL300 (without contour illumination)	ISM-DL301 (with contour illumination)
Magnification	15X~100X	
Sensor	1/2" CMOS	
Pixel	2M	
Resolution	1920×1080	
Frame rate	60fps	
Output	HDMI	
Power supply	power adapter	
Dimension (L×W×H)	570×300×430mm	
Weight	6.5kg	

To be continued

Continued from previous page

STANDARD DELIVERY

Code	ISM-DL300	ISM-DL301
Main unit	1 pc	1 pc
0.5X camera adapter	1 pc	1 pc
1X auxiliary objective	1 pc	1 pc
Calibration plate	1 pc	1 pc
16G USB flash disk	1 pc	1 pc
White/black plate	1 pc	1 pc
Mouse	1 pc	1 pc
HDMI cable	1 pc	1 pc
Power adapter	2 pcs	3 pcs

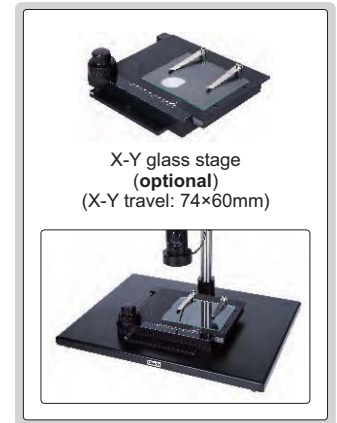
OPTIONAL ACCESSORY

1X camera adapter	ISM-DL-CA1X
2X auxiliary objective	ISM-DL-OB2X
X-Y glass stage (travel: 74×60mm)	ISM-DL-STAGE
X-Y metal stage	ISM-DL-STAGE1
LED light	page 329~330
Auxiliary objective	page 331

MAGNIFICATION AND MEASURING ACCURACY

Objective magnification	Image magnification	Measuring accuracy*
0.75X	15X	±8μm
1X	20X	±7μm
1.5X	30X	±6μm
2X	40X	±6μm
2.5X	50X	±6μm
3X	60X	±5μm
3.5X	70X	±5μm
4X	80X	±4μm
4.5X	90X	±4μm
5X	100X	±4μm

* When measuring the contour of workpieces, please use ISM-DL301 to ensure accuracy.

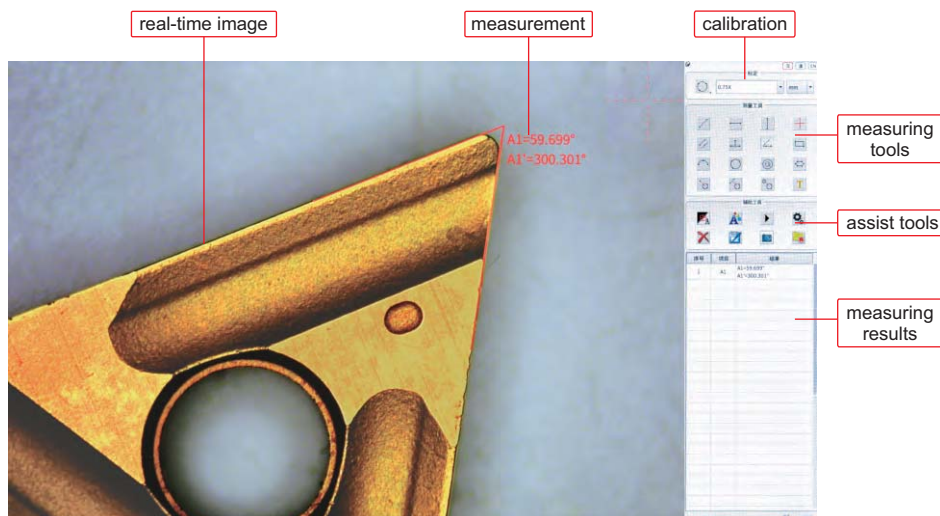


MAGNIFICATION, FOCUS DISTANCE AND VIEW FIELD

Auxiliary objective	Specification	Camera adapter	
		0.5X (included)	1X (optional)
1X (included)	Magnification	15~100X	30~200X
	Focus distance	70±2mm	70±2mm
	View filed	16×11~2.5×1.6mm	7.8×5.3~1.2×0.8mm
2X (optional)	Magnification	30~200X	60~400X
	Focus distance	29±2mm	29±2mm
	View filed	7.8×5.3~1.2×0.8mm	3.8×2.7~0.6×0.4mm

SOFTWARE (INCLUDED)

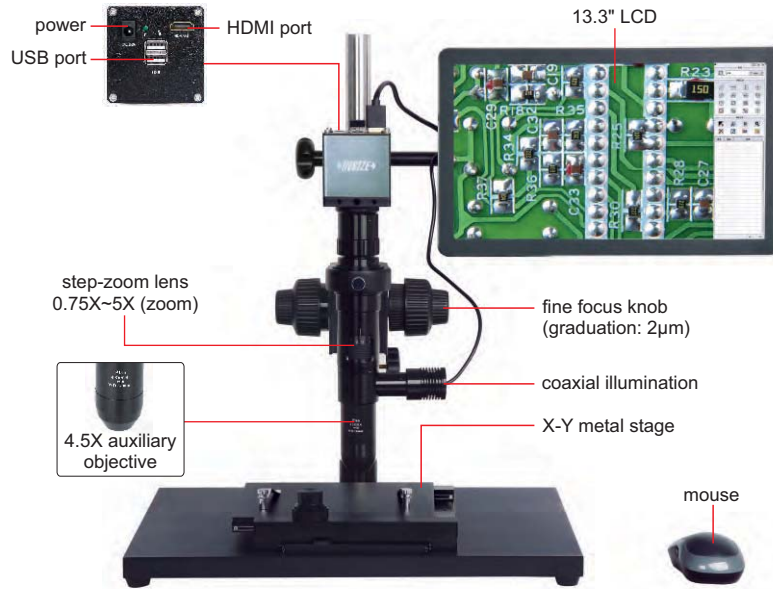
■ Refer to page 326 for details



SOFTWARE IS INCLUDED,
REFER TO PAGE 326 FOR DETAILS

HIGH MAGNIFICATION MEASURING MICROSCOPE (WITH DISPLAY) CODE ISM-DL302

OBSERVATION AND MEASUREMENT
AT HIGH MAGNIFICATION



calibration plate
(included)



16G USB flash disk
(included)



0.5X camera adapter
(included)



1X camera adapter
(optional)

- 1080P high-definition image
- Maximum 1000X optical magnification (using camera adapter 1X, optional)
- Built-in software without computer, operated by mouse
- Solid base and column to avoid lens shaking during focusing
- Software is included, refer to page 326 for details

SPECIFICATION

Magnification	78X~504X
Sensor	1/2" CMOS
Pixel	2M
Resolution	1920×1080
Frame rate	60fps
Output	HDMI
Power supply	power adapter
Dimension(L×W×H)	570×300×430mm
Weight	15kg

SATNDARD DELIVERY

Main unit	1 pc
0.5X camera adapter	1 pc
4.5X auxiliary objective	1 pc
Calibration plate	1 pc
16G USB flash disk	1 pc
Mouse	1 pc
HDMI cable	1 pc
X-Y metal stage	1 pc

OPTIONAL ACCESSORY

1X camera adapter	ISM-DL-CA1X
LED light	page 329~330

MAGNIFICATION AND MEASURING ACCURACY

Objective magnification	Image magnification	Measuring accuracy
0.75X	78X	±5µm
1X	102X	±4µm
1.5X	153X	±4µm
2X	204X	±4µm
2.5X	255X	±4µm
3X	305X	±4µm
3.5X	356X	±4µm
4X	408X	±4µm
4.5X	458X	±4µm
5X	504X	±4µm

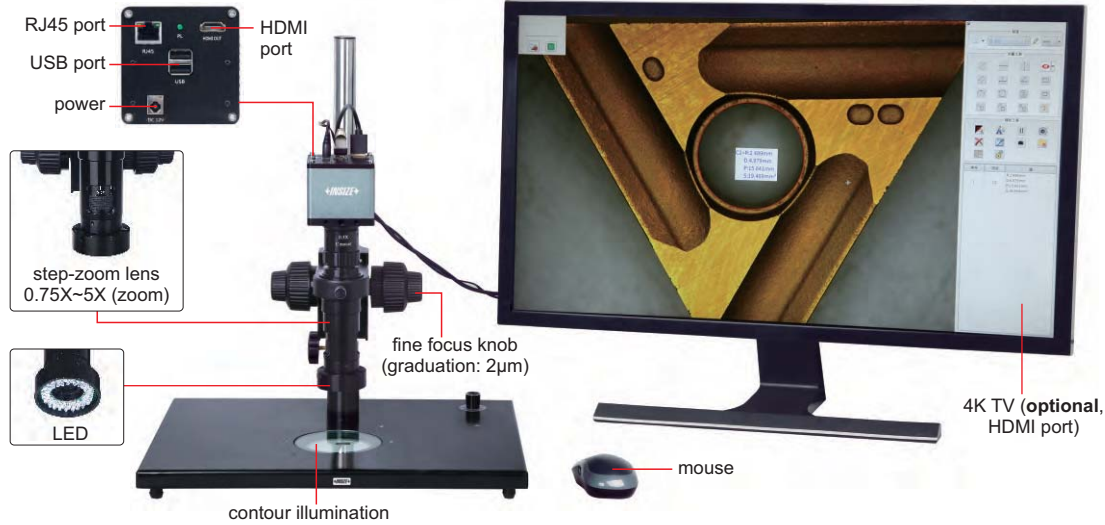
MAGNIFICATION, FOCUS DISTANCE AND VIEW FIELD

Camera adapter	0.5X (included)	1X (optional)
Magnification	78~504X	156~1008X
Focus distance	14±2mm	14±2mm
View field	2.8×1.7~0.5×0.3mm	1.4×0.9~0.3×0.2mm

HIGH-DEFINITION MEASURING MICROSCOPE CODE ISM-DL500

ATTENTION: PLEASE MAKE CONFOCAL ADJUSTMENT AFTER CHANGING CAMERA ADAPTERS OR AUXILIARY OBJECTIVES

BUILT-IN SOFTWARE
WITHOUT COMPUTER



- 5 megapixel high-definition image
- Built-in software without computer, operated by mouse
- Take pictures, save to USB flash disk
- Measurement results can be sent to Excel
- Automatic white balance and exposure
- Send photos and measurement data via ethernet (TCP/IP)
- Name photos and measurement data files with serial number of workpieces read by scanner

17



0.5X camera adapter (included)



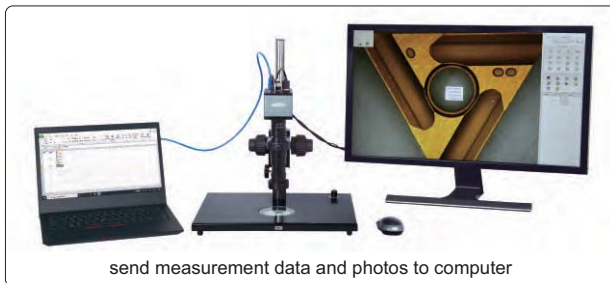
1X camera adapter (optional)



1X auxiliary objective (included)



2X auxiliary objective (optional)



SPECIFICATION

Magnification (on 28" TV)	30X~200X
Sensor	1/1.8" CMOS
Pixel	5M
Resolution	3072×1728
Frame rate	60fps
Output	HDMI
Power supply	power adapter
Dimension (L×W×H)	570×300×430mm

To be continued

Continued from previous page

STANDARD DELIVERY

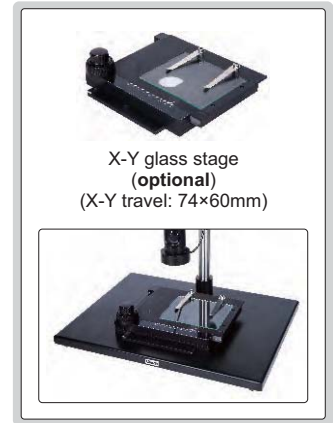
Main unit	1 pc
0.5X camera adapter	1 pc
1X auxiliary objective	1 pc
Calibration plate	1 pc
16G USB flash disk	1 pc
White/black plate	1 pc
Mouse	1 pc
Power adapter	2 pcs

OPTIONAL ACCESSORY

1X camera adapter	ISM-DL-CA1X
2X auxiliary objective	ISM-DL-OB2X
X-Y glass stage (travel: 74×60mm)	ISM-DL-STAGE
28" 4K TV	7313-TV28
Scanner and hub	7316-SCAN1
LED light	page 329~330
Auxiliary objective	page 331

MAGNIFICATION AND MEASURING ACCURACY

Objective magnification	Image magnification (on 28" TV)	Measuring accuracy
0.75X	30X	±6μm
1X	40X	±6μm
1.5X	60X	±5μm
2X	80X	±5μm
2.5X	100X	±5μm
3X	120X	±4μm
3.5X	140X	±4μm
4X	160X	±3μm
4.5X	180X	±3μm
5X	200X	±3μm

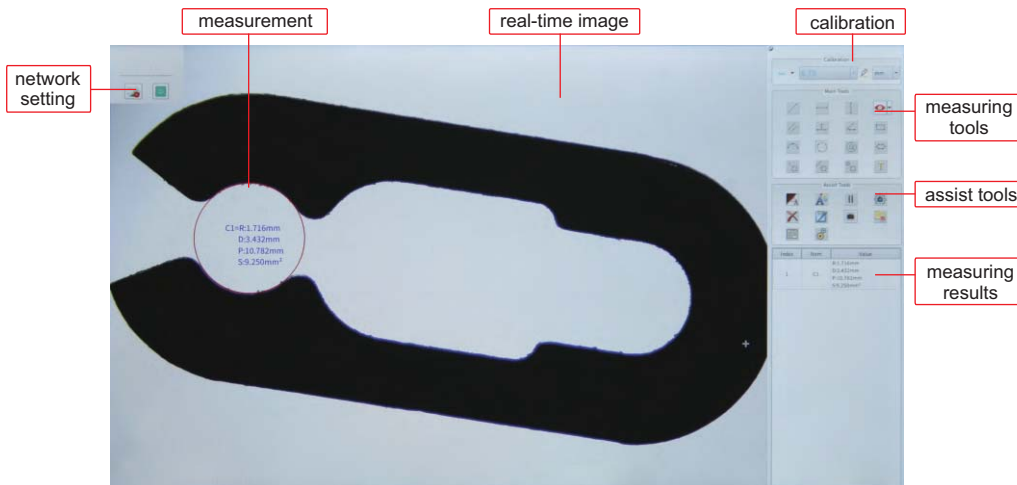


MAGNIFICATION, FOCUS DISTANCE AND VIEW FIELD (ON 28" TV)

Auxiliary objective	Specification	Camera adapter	
		0.5X (included)	1X (optional)
1X (included)	Magnification	30~200X	60~400X
	Focus distance	70±2mm	70±2mm
	View filed	16.5×11.5~2.5×1.7mm	8.2×5.7~1.3×0.9mm
2X (optional)	Magnification	60~400X	120~800X
	Focus distance	29±2mm	29±2mm
	View filed	8.2×5.7~1.3×0.9mm	4.1×2.8~0.6×0.4mm

SOFTWARE (INCLUDED)

- Refer to page 326 for details

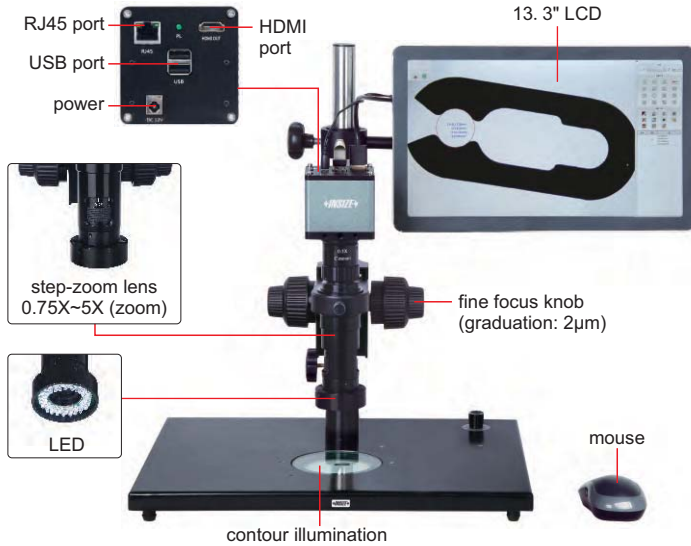


FOCUS STACKING MEASURING MICROSCOPE (WITH DISPLAY) CODE ISM-DL510

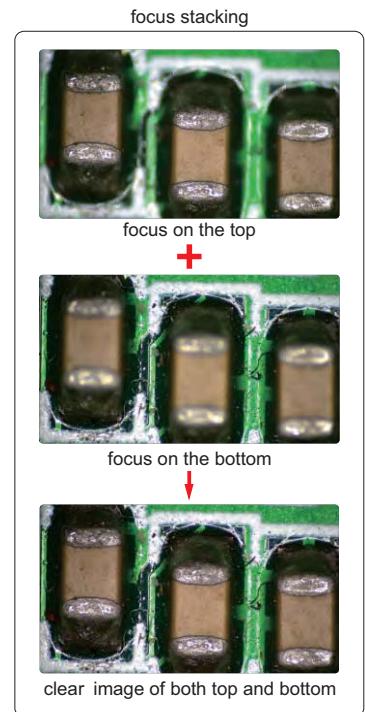
BUILT-IN SOFTWARE
WITHOUT COMPUTER

FOCUS
STACKING

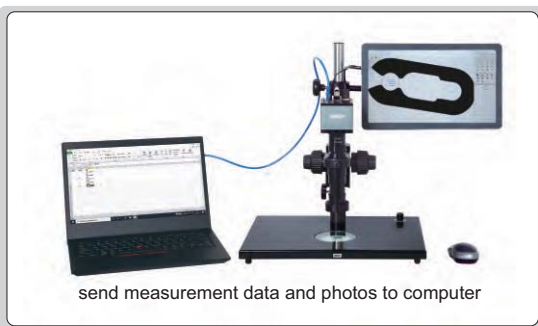
ATTENTION: PLEASE MAKE CONFOCAL ADJUSTMENT AFTER
CHANGING CAMERA ADAPTERS OR AUXILIARY OBJECTIVES



- 1080P high-definition image
- Built-in software without computer, operated by mouse
- Take pictures, save to USB flash disk
- Measurement results can be sent to Excel
- Automatic white balance and exposure
- Focus stacking
- Send photos and measurement data via ethernet (TCP/IP)
- Name photos and measurement data files with serial number of workpieces read by scanner



17



SPECIFICATION

Magnification	15X~100X
Sensor	1/2" CMOS
Pixel	2M
Resolution	1920×1080
Frame rate	60fps
Output	HDMI
Power supply	power adapter
Dimension (L×W×H)	570×300×430mm



To be continued

Continued from previous page

STANDARD DELIVERY

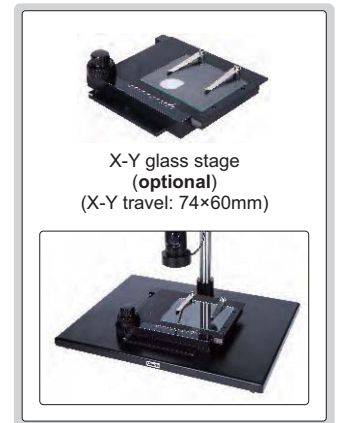
Main unit	1 pc
0.5X camera adapter	1 pc
1X auxiliary objective	1 pc
Calibration plate	1 pc
16G USB flash disk	1 pc
White/black plate	1 pc
Mouse	1 pc
Power adapter	3 pcs

OPTIONAL ACCESSORY

1X camera adapter	ISM-DL-CA1X
2X auxiliary objective	ISM-DL-OB2X
X-Y glass stage (travel: 74×60mm)	ISM-DL-STAGE
Scanner and hub	7316-SCAN1
LED light	page 329~330
Auxiliary objective	page 331

MAGNIFICATION AND MEASURING ACCURACY

Objective magnification	Image magnification	Measuring accuracy
0.75X	15X	±8μm
1X	20X	±7μm
1.5X	30X	±6μm
2X	40X	±6μm
2.5X	50X	±6μm
3X	60X	±5μm
3.5X	70X	±5μm
4X	80X	±4μm
4.5X	90X	±4μm
5X	100X	±4μm

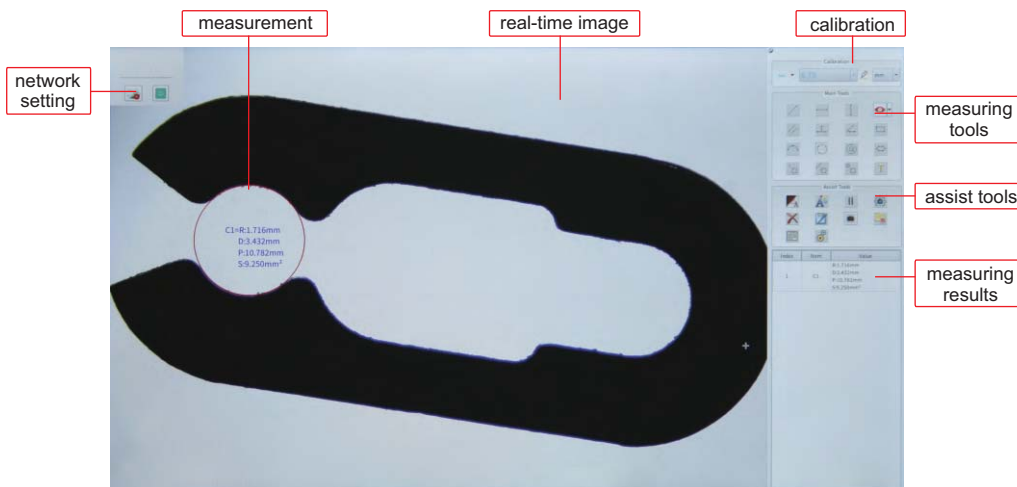


MAGNIFICATION, FOCUS DISTANCE AND VIEW FIELD

Auxiliary objective	Specification	Camera adapter	
		0.5X (included)	1X (optional)
1X (included)	Magnification	15~100X	30~200X
	Focus distance	70±2mm	70±2mm
	View filed	16×11~2.5×1.6mm	7.8×5.3~1.2×0.8mm
2X (optional)	Magnification	30~200X	60~400X
	Focus distance	29±2mm	29±2mm
	View filed	7.8×5.3~1.2×0.8mm	3.8×2.7~0.6×0.4mm

SOFTWARE (INCLUDED)

- Refer to page 326 for details



DIGITAL MEASURING MICROSCOPE CODE 5307-ID100A

ELECTRONIC MAGNIFICATION
FEEDBACK LENS

BUILT-IN SOFTWARE
WITHOUT COMPUTER



- Electronic magnification feedback lens: when the objective lens magnification is changed manually, the software automatically selects the corresponding pre-calibration data and calibration is not needed
- Two methods of LED brightness adjustment, knob adjustment and software adjustment
- Built-in software without computer, operated by mouse
- Take pictures, save to USB flash disk
- Measuring results can be sent to Excel

adjustable display angle



SPECIFICATION

Sensor	1/2" CMOS
Pixel	2M
Resolution	1920×1080
Magnification	12~77X
Focus distance	100mm
View field	2.7×1.9~17.5×11.9mm
Max workpiece height	60mm
Frame rate	60fps
Output	USB/HDMI
Power supply	power adapter
Dimension (L×W×H)	610×610×660mm
Weight	4.5kg

MAGNIFICATION AND MEASURING ACCURACY

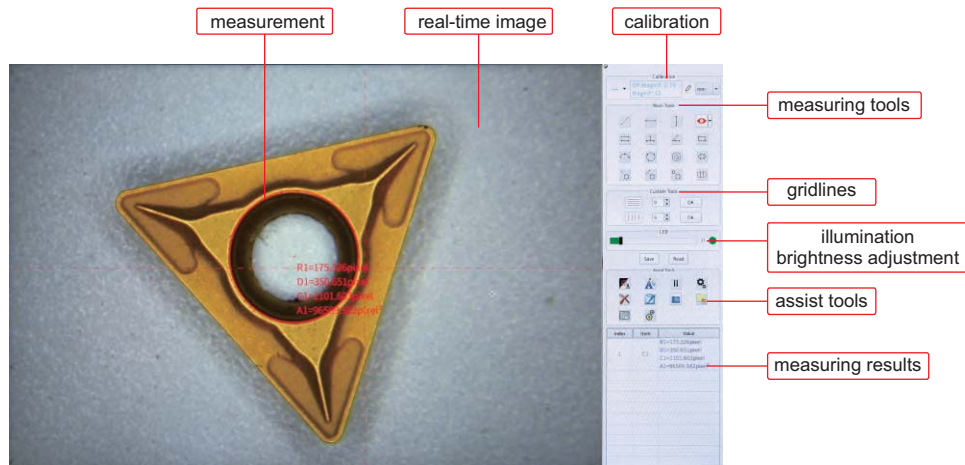
Objective magnification	Magnification	Measuring accuracy
0.7X	12X	±9μm
1X	17X	±9μm
1.5X	26X	±8μm
2X	35X	±7μm
2.5X	43X	±7μm
3X	51X	±7μm
3.5X	60X	±6μm
4X	68X	±6μm
4.5X	77X	±5μm

STANDARD DELIVERY

Main unit	1 pc
Calibration plate	1 pc
Power adapter	1 pc
Mouse	1 pc
16G USB flash disk	1 pc

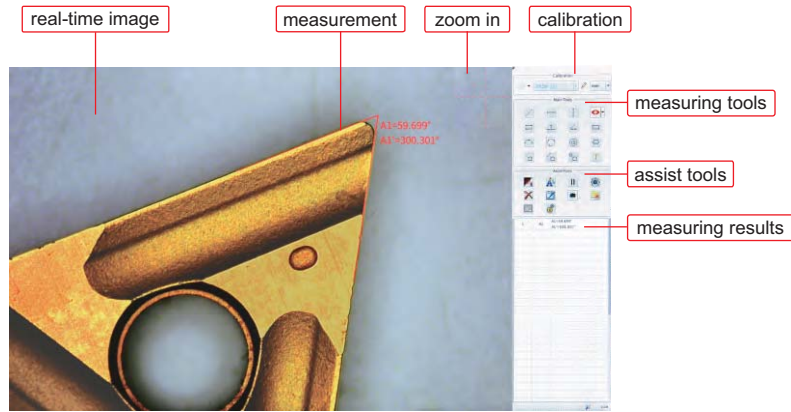
SOFTWARE (INCLUDED)

- Refer to page 326 for details

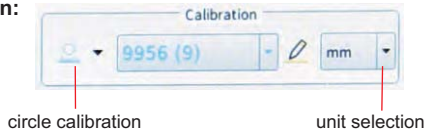


SOFTWARE CAN BE CUSTOMIZED

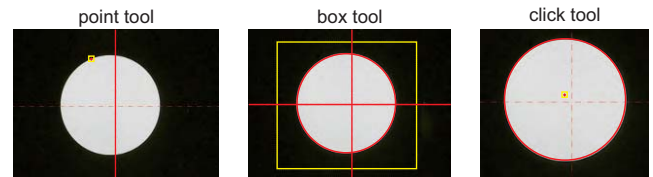
MEASURING SOFTWARE OF DIGITAL MICROSCOPES



- **Included in digital microscopes (ISM-DL300, ISM-DL301, ISM-DL302, ISM-DL500, ISM-DL510, 5307-ID100A)**
- **Language:** Simplified Chinese, Traditional Chinese, English, Korean
- **Calibration:**



▪ Edge-detection:



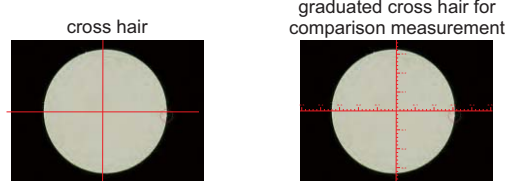
▪ Measurement tools:

- | | | |
|--|---|---|
| measure length of line or distance between two points | measure length of line or distance between two points in horizontal direction | measure length of line or distance between two points in vertical direction |
| measure angle from horizontal line | measure angle from vertical line | measure angle of two lines |
| measure distance between two parallel lines | measure distance between two parallel lines | measure distance between multiple parallel lines |
| measure distance between point and line | measure radius, length and angle of arc | measure girth and area of polygon |
| measure radius, diameter, girth and area of circle with three points | measure radius, diameter, girth and area concentric of circles | measure length, width, girth and area of rectangle |
| measure minimum distance between point and circle | measure distance between point and center of circle | measure maximum distance between point and circle |
| measure minimum distance between line and circle | measure distance between line and center of circle | measure maximum distance between line and circle |
| measure minimum distance between two circles | measure center distance between two circles | measure maximum distance between two circles |
| add text | measure radius, diameter, girth and area of circle with two points | cross hair and graduated cross hair |

▪ Assist tools:

- | | |
|--------------------------------------|-----------------------------------|
| manual/automatic point selection | delete images |
| line width and color settings | export measurement data to U disk |
| freeze screen | take pictures and save |
| camera parameter settings | review pictures |
| layout settings of measurement items | system settings |

▪ Cross hair:



▪ Grid comparison measurement:



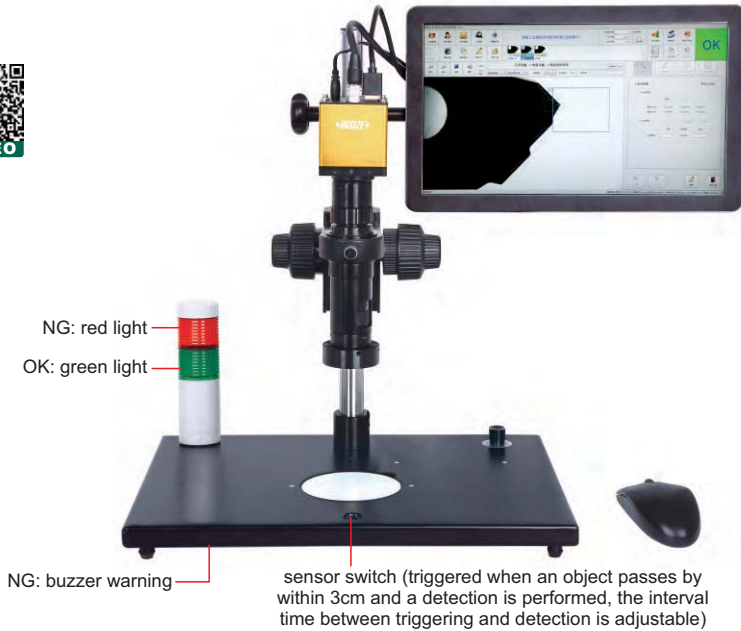
▪ Output to Excel:

1	A1	A1=59.699° A1=300.301°

SMART MICROSCOPE CODE ISM-DL400

**AUTOMATICALLY LOCATE WORKPIECES
REGARDLESS OF POSITION AND DIRECTION**

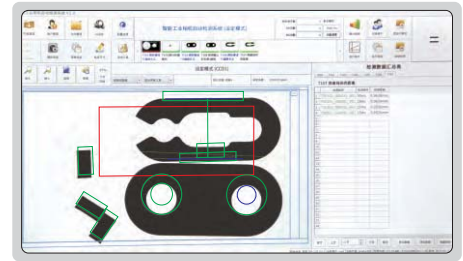
**BUILT-IN SOFTWARE
WITHOUT COMPUTER**



camera function

- surface defect detection
- dimension measurement
- read barcode
- burr detection
- contour matching
- character recognition
- color detection
- read QR code
- object counting
- thread measurement

detect different workpieces at one time



- Automatically identify different workpieces
- Automatically locate workpieces regardless of position and direction
- Built-in software, PLC control input and output interface
- Including multiple detection tools
- Automatically calculate, store the test results and export to Excel

Tool	Performance	OK Count	NG Count	OK Rate	Defective rate
T101	Profilometer	400	200	200	50.00%
T102	Caliper	50	50	25	50.00%
T103	Caliper	400	200	200	50.00%

report showing the perform times of each tool, quantity of OK and NG, the report can be saved

Tool	Tool	Tool		
T102 Cluster				
Detection number	Detection time	Detection color	Number of layers	Maximum value
1	T00101_00041_001	31ms	白色	0
2	T00101_00153_001	31ms	白色	0
3	T00101_00102_001	31ms	白色	0

report of each detection is automatically created and saved

SPECIFICATION

Magnification	15X~100X
Resolution	1920×1080
Pixel	2M
Single pixel size	3.75×3.75μm
Frame rate	60fps
Sensor	1/2" CMOS
Chip structure	FPGA+ARM
Operating system	Linux 3.10
Power supply	power adapter
Dimension (L×W×H)	570×300×430mm
Weight	6.5kg

STANDARD DELIVERY

Main unit	1 pc
0.5X camera adapter	1 pc
1X auxiliary objective	1 pc
Calibration plate	1 pc
16G USB flash disk	1 pc
White/black plate	1 pc
HDMI cable	1 pc
Power adapter	3 pcs

MAGNIFICATION, FOCUS DISTANCE AND VIEW FIELD

Auxiliary objective	Specification	Camera adapter	
		0.5X (included)	1X (optional)
1X (included)	Magnification	15~100X	30~200X
	Focus distance	70±2mm	70±2mm
	View filed	16×11~2.5×1.6mm	7.8×5.3~1.2×0.8mm
2X (optional)	Magnification	30~200X	60~400X
	Focus distance	29±2mm	29±2mm
	View filed	7.8×5.3~1.2×0.8mm	3.8×2.7~0.6×0.4mm

OPTIONAL ACCESSORY

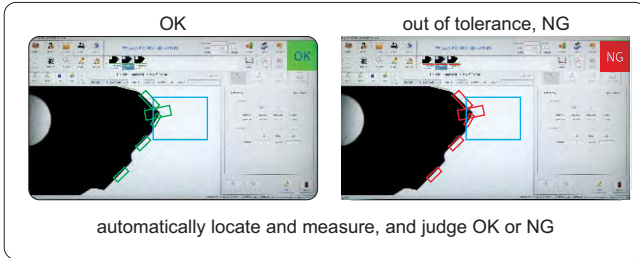
1X camera adapter	ISM-DL-CA1X
2X auxiliary objective	ISM-DL-OB2X
LED light	page 329~330
Auxiliary objective	page 331

To be continued

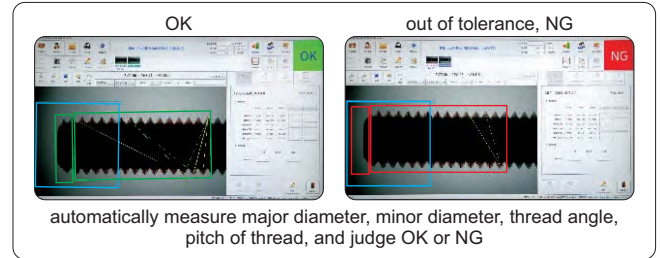
Continued from previous page

■ APPLICATION EXAMPLES:

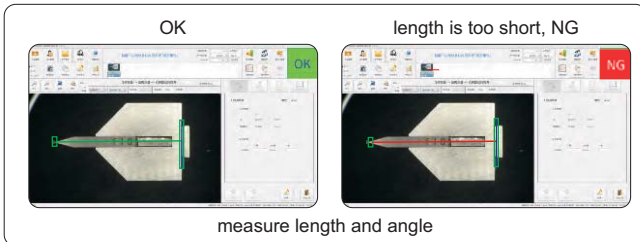
dimension measurement



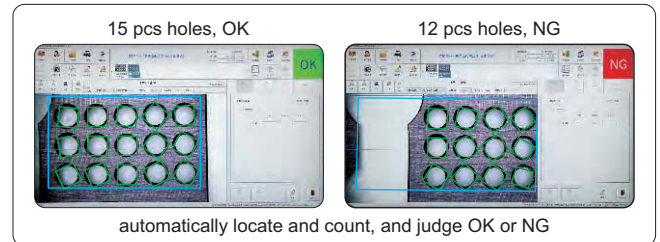
thread measurement



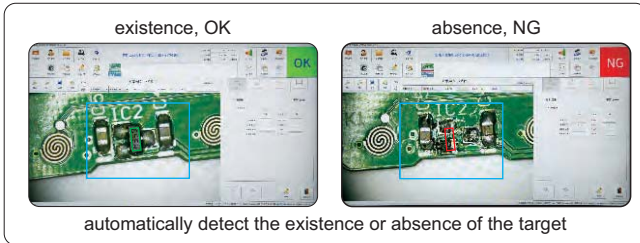
cutting tools measurement



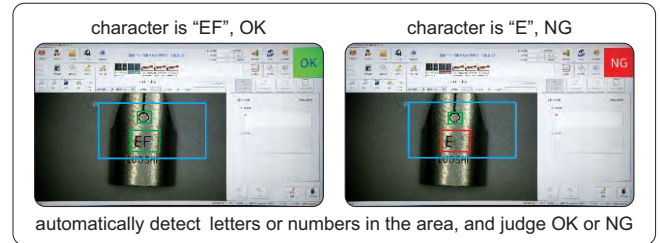
counting



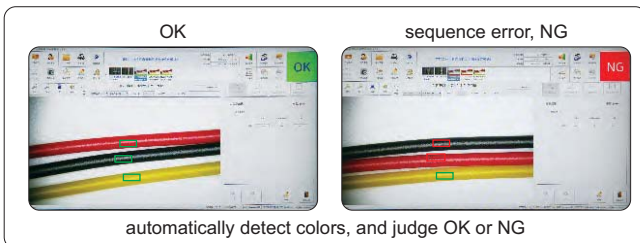
existence or absence



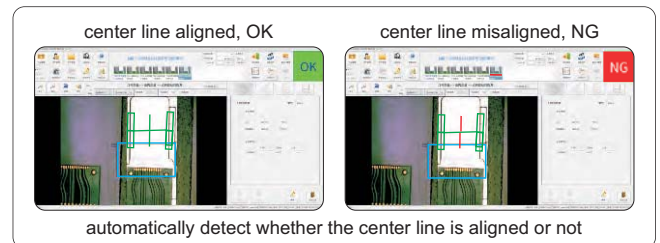
character recognition



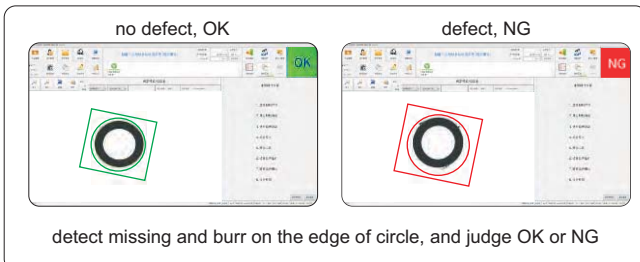
color detection



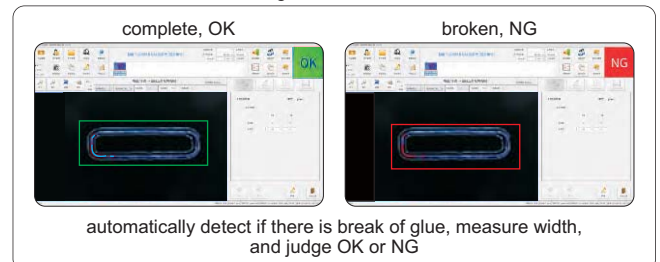
location detection



surface defect detection



glue detection



X-Y METAL STAGE CODE ISM-DL-STAGE1

- Suitable for digital microscopes **ISM-DL300**, **ISM-DL301**, **5303-AF103**, **ISM-DL500**, **ISM-DL510**

SPECIFICATION

X-Y travel range	100×86mm
Dimension (L×W×H)	180×180×50mm
Weight	2.3kg



LED RING LIGHT CODE ISM-LED-9245R

- Diffuser plate is included to reduce the reflective effect on workpieces
- Suitable for digital microscopes **ISM-DL400**, **ISM-DL300**, **ISM-DL301**, **5303-AF103**, **ISM-DL500**, **ISM-DL510**

SPECIFICATION

Light color	white
Power supply	24V
Power	5.5W
Angle	45°
Outside/inside diameter	92/52mm

RED, GREEN, BLUE, INFRARED AND UV LIGHT CAN BE CUSTOMIZED

ATTENTION: MUST BE USED WITH LIGHT BRACKET AND LIGHT CONTROLLER



LED SQUARE LIGHT CODE ISM-LED-100L4

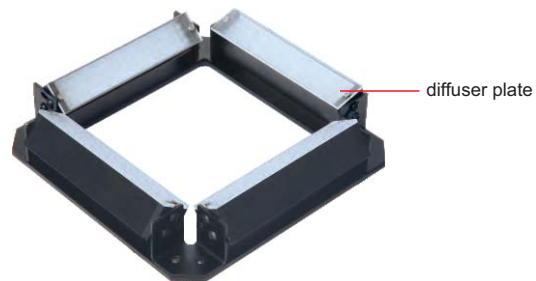
- Diffuser plate is included to reduce the reflective effect on workpieces
- Angle and brightness can be adjusted independently
- Suitable for digital microscopes **ISM-DL400**, **ISM-DL300**, **ISM-DL301**, **5303-AF103**, **ISM-DL500**, **ISM-DL510**

SPECIFICATION

Light color	white
Power supply	24V
Power	10.36W
Angle	0~90°
Dimension (L×W×H)	154×154×30mm

RED, GREEN, BLUE, INFRARED AND UV LIGHT CAN BE CUSTOMIZED

ATTENTION: MUST BE USED WITH LIGHT BRACKET AND LIGHT CONTROLLER

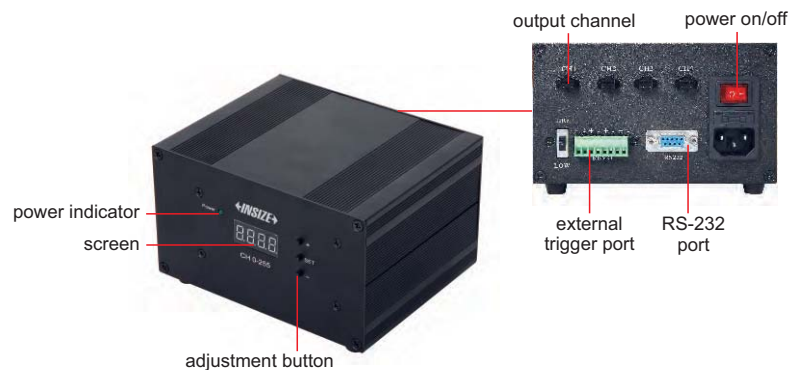


DIGITAL LIGHT CONTROLLER CODE ISM-LED-CTRL

- 256 (0-255) steps of brightness adjustment
- With power off memory function and short circuit protection function
- Suitable for **ISM-LED-100L4**, **ISM-LED-9245R**

SPECIFICATION

Power supply	100~240V, 50/60HZ
Output power (rated)	60W
Output voltage (rated)	24V
Dimension (L×W×H)	145×118×83mm



BRACKET FOR LIGHTS CODE ISM-LED-BRACKET



L-shape metal

- 4 pcs L-shape bars are included, multiple combinations can be realized
- Suitable for ISM-LED-100L4, ISM-LED-9245R

application



SPECIFICATION

Size (L×W×H)	260×300×20mm
Weight	0.7kg

DUAL HEAD LED LIGHT CODE ISM-ZS-LED

- Adjustable illumination
- For digital and stereo microscopes

SPECIFICATION

Power	3W
Power supply	100~240V
Working	10000h
Illumination	10000lux



application



LED AUXILIARY LIGHT CODE ISM-DL-LED

- Suitable for digital microscopes
ISM-DL300, ISM-DL301, ISM-DL302,
ISM-DL400, 5303-AF103, ISM-DL500,
ISM-DL510

SPECIFICATION

Power	8W
Diameter of mounting hole	Ø25mm
Power supply	10~12V, 0~300mA



illumination direction and brightness are adjustable

COAXIAL LIGHT LIGHT CODE ISM-DL-COAXIAL

- Suitable for digital microscopes
5303-AF103, ISM-DL300, ISM-DL301,
ISM-DL400, ISM-DL500, ISM-DL510

SPECIFICATION

Power	1W
Power supply	0~3.4V, 0~400mA



for smooth surfaces and small holes, brightness is adjustable

AUXILIARY OBJECTIVES

ATTENTION: PLEASE MAKE CONFOCAL ADJUSTMENT AFTER CHANGING CAMERA ADAPTERS OR AUXILIARY OBJECTIVES



0.3X auxiliary objective
ISM-DL-OB03X



0.5X auxiliary objective
ISM-DL-OB05X



0.75X auxiliary objective
ISM-DL-OB075X



1X auxiliary objective
ISM-DL-OB1X



1.5X auxiliary objective
ISM-DL-OB1D5X



2X auxiliary objective
ISM-DL-OB2X

- Suitable for digital microscopes 5303-AF103, ISM-DL300, ISM-DL301, ISM-DL400, ISM-DL500, ISM-DL510

MAGNIFICATION, FOCUS DISTANCE AND VIEW FIELD (5303-AF103)

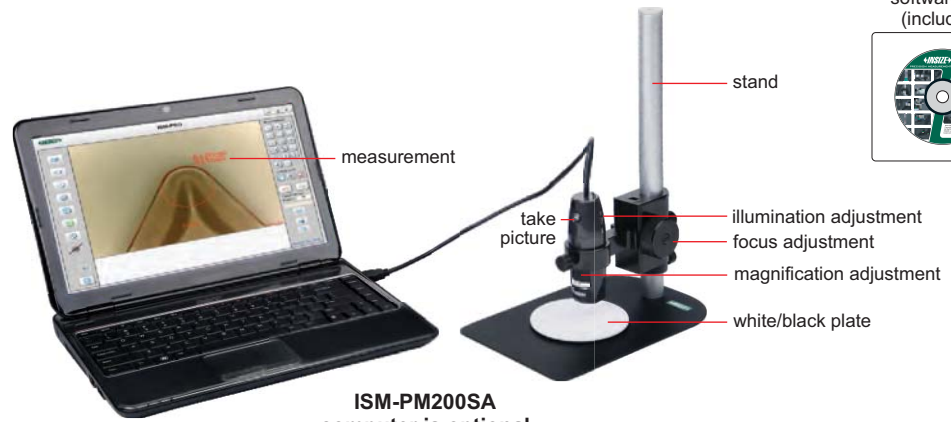
Auxiliary objective	Specification	Camera adapter	
		0.5X (included)	1X (optional)
0.3X (optional)	Magnification	6~37X	12~74X
	Focus distance	120~310mm	120~310mm
	View field	52×30~8×5mm	26×15~4×2.5mm
0.5X (optional)	Magnification	10~61X	20~123X
	Focus distance	78~230mm	78~230mm
	View field	37×20~5×3mm	18×10~2.5×1.5mm
0.75X (optional)	Magnification	15~92X	30~184X
	Focus distance	60~125mm	60~125mm
	View field	21×13~3.4×2mm	10×6.5~1.7×1mm
1X (included)	Magnification	20~123X	40~246X
	Focus distance	48~84mm	48~84mm
	View field	15×8~2.5×1.5mm	7.5×4~1.3×0.7mm
1.5X (optional)	Magnification	30~184X	60~368X
	Focus distance	36~63mm	36~63mm
	View field	10×6~1.7×1mm	5×3~0.9×0.5mm
2X (optional)	Magnification	40~246X	80~492X
	Focus distance	24~42mm	24~42mm
	View field	7.5×4~1.3×0.7mm	3.8×2~0.7×0.4mm

MAGNIFICATION, FOCUS DISTANCE AND VIEW FIELD (ISM-DL300, ISM-DL301, ISM-DL500, ISM-DL510)

Auxiliary objective	Specification	Camera adapter	
		0.5X (included)	1X (optional)
0.3X* (optional)	Magnification	5~34X	10~68X
	Focus distance	287±2mm	287±2mm
	View field	42×26~6.5×4.5mm	21×13~3.3×2.3mm
0.5X* (optional)	Magnification	9~56X	18~112X
	Focus distance	166±2mm	166±2mm
	View field	25.6×16.8~5×3.5mm	12.8×8.4~2×1.3mm
0.75X* (optional)	Magnification	13~84X	26~168X
	Focus distance	105±2mm	105±2mm
	View field	17×10.5~2.6×1.7mm	8.5×5.3~1.3×0.9mm
1X (included)	Magnification	15~100X	30~200X
	Focus distance	70±2mm	70±2mm
	View field	16×11~2.5×1.6mm	7.8×5.3~1.2×0.8mm
1.5X (optional)	Magnification	26~168X	52~336X
	Focus distance	42±2mm	42±2mm
	View field	8.5×5.2~1.3×0.9mm	4.3×2.6~0.7×0.5mm
2X (optional)	Magnification	30~200X	60~400X
	Focus distance	29±2mm	29±2mm
	View field	7.8×5.3~1.2×0.8mm	3.8×2.7~0.6×0.4mm

*For auxiliary objectives 0.3X, 0.5X, 0.75X, use contour illumination of ISM-DL301, ISM-DL500, ISM-DL510 or LED light

DIGITAL MEASURING MICROSCOPES



- Can take pictures and videos
- Supplied with software
- Calibration rules (graduation 0.1 and 1mm) are included

ISM-PM200SA
computer is optional

SPECIFICATION

Code	ISM-PM200SA	ISM-PM200SB
Magnification	10X~200X	10X~200X
Stand	standard	universal
Pixel	2M (resolution: 1600×1200)	
Illumination	built-in adjustable LED	
Power supply	USB 2.0 cable (voltage required: 5±0.1V)	

OPTIONAL ACCESSORY

Green filter	ISM-PM-GREEN
Yellow filter	ISM-PM-YELLOW
Blue filter	ISM-PM-BLUE

universal stand (included in ISM-PM200SB)



filter (optional)



MAGNIFICATION, FOCUS DISTANCE, VIEW FIELD AND ACCURACY

Magnification	Focus distance	View field	Accuracy
50X	21mm	8.1×6.4mm	30µm
100X	13mm	3.9×3.1mm	15µm
150X	16mm	2.6×2.1mm	10µm
200X	19mm	1.8×1.5mm	8µm

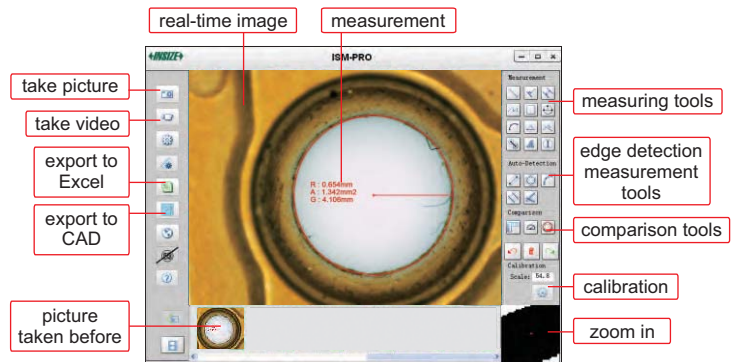
SOFTWARE

- Language:** English, Japanese, Korean, German, Turkey, Portuguese, Chinese
- Operation system:** Windows 7/8/XP/Vista
- Measuring tools:**

- | | | | |
|--|---|--|--|
| | measure length of line or distance between two points | | measure radius, length and angle of arc |
| | measure area of rectangle | | add number with circle |
| | measure distance between two circles | | measure length of continuous line |
| | measure distance between two parallel lines | | measure angle with three points |
| | measure angle with two lines | | measure radius, girth and area of circle |
| | measure distance between point and line | | add text |

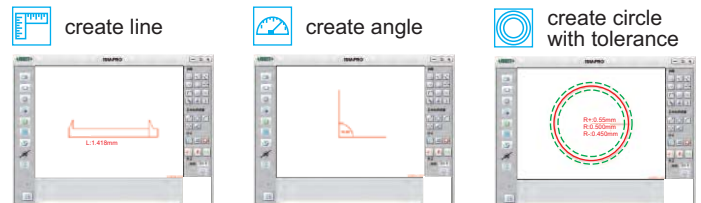
Edge detection measurement tools:

- detect two parallel lines automatically and calculate distance
- detect circle automatically, and calculate radius, girth and area
- detect arc automatically, and calculate radius, angle and arc length
- detect two lines automatically, and calculate angle
- detect line automatically, and calculate length



Comparison tools:

- Create line, angle or circle with desired size, to compare with workpieces



Data export to CAD or Excel:



WiFi DIGITAL MEASURING MICROSCOPE CODE ISM-WF200



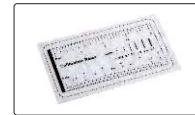
- Maximum working distance is 5m under WiFi mode
- Can be connected to multiple iPads, Android devices or computers together under WiFi mode
- Take pictures and videos
- Supplied with software



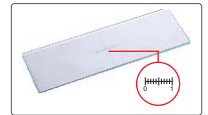
stand (code ISM-PM-STAND, optional)



software CD (included)



plastic calibration rule (graduation 1mm, included)



glass calibration rule (graduation 0.1mm, included)

SPECIFICATION

Magnification	10X~200X
Pixel	1.3M (resolution: 1280×1024)
Illumination	built-in adjustable LED
Power supply	built-in rechargeable battery



STANDARD DELIVERY

Microscope	1 pc
Focus support ring for 80X/150X	1 pc
Focus support ring for 60X/200X	1 pc
Glass calibration rule (graduation 0.1mm)	1 pc
Plastic calibration rule (graduation 1mm)	1 pc
Software and USB cable	1 pc
AC/DC adapter	1 pc



OPTIONAL ACCESSORY

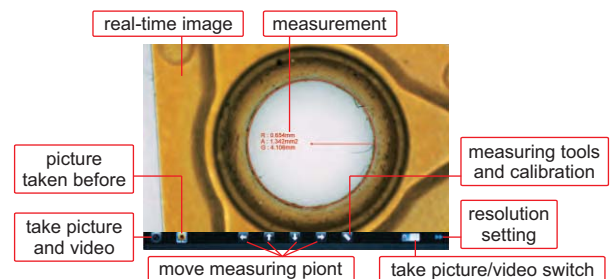
Stand	ISM-PM-STAND
Green filter	ISM-PM-GREEN
Yellow filter	ISM-PM-YELLOW
Blue filter	ISM-PM-BLUE

MAGNIFICATION, FOCUS DISTANCE, VIEW FIELD AND ACCURACY

Magnification	Focus distance	View field	Accuracy
50X	21mm	8.1×6.4mm	30μm
100X	13mm	3.9×3.1mm	15μm
150X	16mm	2.6×2.1mm	10μm
200X	19mm	1.8×1.5mm	8μm

1 Software ISM-PAD (for iPad by WiFi)

- measure length of line or distance between two points
- measure radius, girth and area of circle with three points
- measure angle

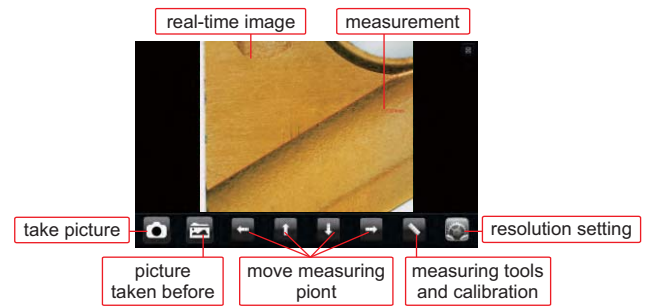


To be continued

Continued from previous page

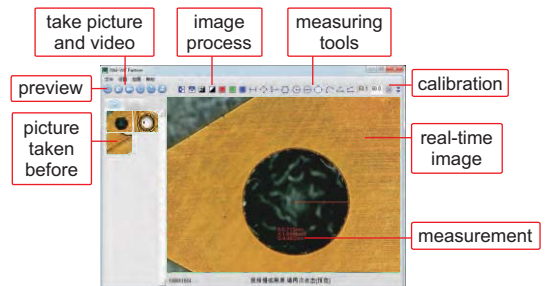
2 Software ISM-APK (for Android devices by WiFi)

- measure length of line or distance between two points
- measure radius, girth and area of circle with three points
- measure angle



3 Software ISM-WF Partner (for computer by WiFi)

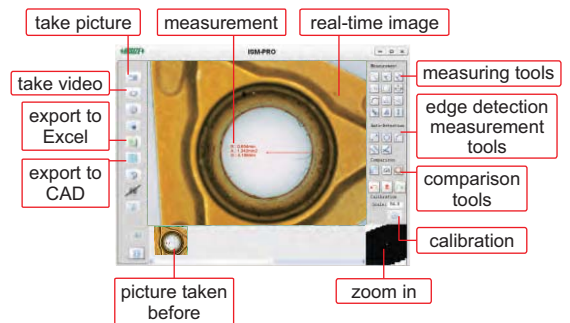
- | | |
|--|--|
| measure length of line or distance between two points | measure angle with two lines |
| measure area of polygon | measure radius, girth and area of circle with two points |
| measure angle with three points | measure distance between point and line |
| measure radius, girth and area of circle with center point | measure radius, length and angle of arc |
| measure length of continuous line | measure area of rectangle |
| measure radius, girth and area of circle with three points | |



4 Software ISM-PRO (for computer by USB cable)

Measuring tools:

- | | |
|---|---|
| measure length of line or distance between two points | measure distance between point and line |
| measure length of continuous line | measure area of rectangle |
| measure radius, length and angle of arc | measure angle with two lines |
| measure distance between two circles | add number with circle |
| measure distance between two parallel lines | measure angle with three points |
| measure radius, girth and area of circle | add text |

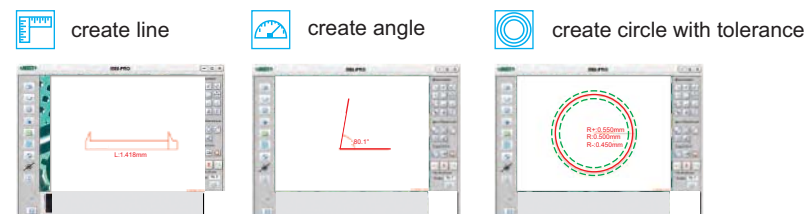


Edge detection measurement tools:

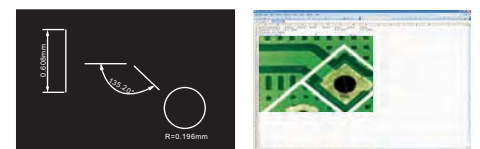
- | | |
|--|--|
| detect line automatically, and calculate length | detect two lines automatically, and calculate angle |
| detect arc automatically, and calculate radius, angle and arc length | detect two parallel lines automatically and calculate distance |
| detect circle automatically, and calculate radius, girth and area | |

Comparison tools:

Create line, angle or circle with desired size, to compare with workpieces



Data export to CAD or Excel:



INDUSTRIAL MICROSCOPES



5101-M500

- Infinite optical system, polarization observation, dark field observation
- Kohler illumination system provides uniform illumination field
- Objective 50X is spring type

SPECIFICATION

Code	5101-M500** (bright field objectives)				5101-M500BD** (bright & dark field objectives)			
Illumination	6V/30W halogen lamp, brightness is adjustable				12V/50W halogen lamp, brightness is adjustable			
Objective (infinite plan achromatic)	bright field objectives				bright & dark field objectives			
	5X	10X	20X	50X	5X	10X	20X	50X
Working distance	26.1mm	20.2mm	8.80mm	3.68mm	9.70mm	9.30mm	7.23mm	2.50mm
Numerical aperture	0.12	0.25	0.40	0.70	0.12	0.25	0.40	0.70
Magnification	50X~500X							
Eyepiece (wide field)	10X (view field: Ø22mm)							
Stage	double layer							
	size: 160×140mm							
	travel: 35x30mm							
Pupil distance	53~75mm							
Diopter adjustment	±5 diopter (one eyepiece)							
Power supply	220V, 50/60Hz **							
Dimension (L×W×H)	415×345×380mm							
Weight	14kg							

** Add "-U" on code No. when power supply is 110V, 50/60Hz

STANDARD DELIVERY

Main unit	1 pc
Anti-dust cover	1 pc

OPTIONAL ACCESSORY

Bright & dark field objective (for 5101-M500BD)	PL40X	5101-M-BD40X
	PL60X	5101-M-BD60X
	PL80X	5101-M-BD80X
	PL100X	5101-M-BD100X
10X dividing eyepiece (0.1mm/div.)		5101-M-EPD10X
Bright field objective (for 5101-M500)	PL40X	5101-M-OB40X
	PL60X	5101-M-OB60X
	PL80X	5101-M-OB80X
	PL100X	5101-M-OB100X
Digital camera		ISM-CM20, ISM-CM63, ISM-ZS70-S
Camera adapter *		5101-M-ADAPTER

* Digital camera must be used with camera adapter



INDUSTRIAL INSPECTION MICROSCOPE (LARGE STAGE) CODE 5104-M700**



- For observation and inspection of large IC and chip in IT industry

SPECIFICATION

Magnification	40X~400X			
Eyepiece (wide field)	10X (view field: Ø22mm)			
Objective (plan achromatic)	4X	10X	20X	40X
Numerical aperture	0.10	0.25	0.40	0.60
Working distance	17.8mm	10mm	5.8mm	2.9mm
Stage	double layer, size: 300×268mm, travel: 250×200mm			
Kohler illumination	6V/20W halogen lamp, brightness is adjustable built-in green, blue, yellow and frosted glasses			
Pupil distance	48~75mm			
Diopter adjustment	±5 diopter (two eyepieces)			
Power supply	220V, 50/60Hz **			
Dimension (L×W×H)	647×268×376mm			
Weight	12kg			

** Add "-U" on code No. when power supply is 110V, 50/60Hz

STANDARD DELIVERY

Main unit	1 pc
Camera connector	1 pc
Anti-dust cover	1 pc

OPTIONAL ACCESSORY

Bright field objective	2.5X plan achromatic objective (focus distance: 11.7mm)	5104-M700-OB2.5X
	5X plan achromatic objective (focus distance: 15.5mm)	5104-M700-OB5X
	50X plan achromatic objective (focus distance: 0.32mm)	5104-M700-OB50X
	100X plan achromatic objective (focus distance: 2mm)	5104-M700-OB100X
Polarizer and analyzer	5104-M700-AP	
Digital camera	ISM-CM20, ISM-CM63, ISM-ZS70-S	
Camera adapter 0.5X *	ISM-MAS-ADAPTER	

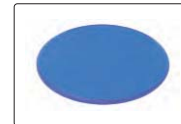
* Digital camera must be used with camera adapter

METALLURGICAL MICROSCOPES



5102-M600

- Infinite optical system, observation in reflected or transmitted illumination, polarizing observation
- Kohler illumination system provides uniform illumination field
- Objectives 40X, 60X are spring type



blue filter (included)



frosted glass filter (included)

SPECIFICATION

Code	5102-M600** (bright field objectives)				5102-M600BD** (bright & dark field objectives)			
illumination	6V/30W (transmitted)		6V/30W (reflected)		12V/30W (transmitted)		12V/50W (reflected)	
Objective (infinite plan achromatic)	bright field objectives				bright & dark field objectives			
	5X	10X	40X	60X	5X	10X	20X	40X
Working distance	26.1mm	20.2mm	3.98mm	3.18mm	9.70mm	9.30mm	7.20mm	3.00mm
Numerical aperture	0.12	0.25	0.60	0.70	0.12	0.25	0.40	0.70
Magnification	50X~600X				50X~400X			
Eyepiece (wide field)	10X (view field: Ø22mm)							
Stage	double layer							
	size: 210×140mm							
	travel: 75×50mm							
Pupil distance	53~75mm							
Diopter adjustment	±5 diopter (one eyepiece)							
Power supply	220V, 50/60Hz**							
Dimension (L×W×H)	456×260×498mm							
Weight	11kg							

** Add "-U" on code No. when power supply is 110V, 50/60Hz

STANDARD DELIVERY

Main unit	1 pc
Anti-dust cover	1 pc
Filter (blue/frosted glass)	1 pc of each

OPTIONAL ACCESSORY

Bright & dark field objective (for 5102-M600BD)	PL50X	5101-M-BD50X
	PL60X	5101-M-BD60X
	PL80X	5101-M-BD80X
	PL100X	5101-M-BD100X
10X dividing eyepiece (0.1mm/div.)		5101-M-EPD10X
Bright field objective (for 5102-M600)	PL20X	5101-M-OB20X
	PL50X	5101-M-OB50X
	PL80X	5101-M-OB80X
	PL100X	5101-M-OB100X
Digital camera		ISM-CM20, ISM-CM63, ISM-ZS70-S
Camera adapter*		5101-M-ADAPTER

* Digital camera must be used with camera adapter

METALLURGICAL MICROSCOPES



5103-M1000

- Infinite optical system, polarization observation
- Kohler illumination system provides uniform illumination field
- Objectives 50X, 100X are spring type

SPECIFICATION

Code	5103-M1000** (bright field objectives)				5103-M1000BD** (bright & dark field objectives)			
illumination	6V/30W halogen lamp, brightness is adjustable				12V/50W halogen lamp, brightness is adjustable			
Objective (infinite plan achromatic)	bright field objectives				bright & dark field objectives			
	10X	20X	50X	100X	5X	10X	20X	50X
Working distance	20.2mm	8.80mm	3.68mm	0.40mm	9.70mm	9.30mm	7.23mm	2.50mm
Numerical aperture	0.25	0.40	0.70	0.85	0.12	0.25	0.40	0.70
Magnification	100X~1000X				50X~500X			
Eyepiece (wide field)	10X (view field: Ø22mm)							
Stage	double layer							
	size: 242×200mm							
	travel: 30x30mm							
Pupil distance	53~75mm							
Diopter adjustment	±5 diopter (one eyepiece)							
Power supply	220V, 50/60Hz **							
Dimension (L×W×H)	614×250×394mm							
Weight	13kg							

** Add "-U" on code No. when power supply is 110V, 50/60Hz

STANDARD DELIVERY

Main unit	1 pc
Polarizer and analyzer	1 pc of each
Anti-dust cover	1 pc

OPTIONAL ACCESSORY

Bright & dark field objective (for 5103-M1000BD)	PL40X	5101-M-BD40X
	PL60X	5101-M-BD60X
	PL80X	5101-M-BD80X
	PL100X	5101-M-BD100X
10X dividing eyepiece (0.1mm/div.)		5103-M-EPD10X
Bright field objective (for 5103-M1000)	PL5X	5101-M-OB5X
	PL40X	5101-M-OB40X
	PL60X	5101-M-OB60X
	PL80X	5101-M-OB80X
Digital camera		ISM-CM63
Camera adapter *		5101-M-ADAPTER

* Digital camera must be used with camera adapter

PARALLEL LIGHT STEREO MICROSCOPE CODE ISM-ZS200

PARALLEL LIGHT PATH: REDUCE FATIGUE,
ACCESSORIES CAN BE ADDED INTO LIGHT PATH



coaxial illumination (optional)



optical path splitter (optional)



iris diaphragm (optional)



- Infinity parallel optical system and 20° inclined optical tube reduce fatigue
- Coaxial illumination is optional for deep holes which cannot be observed by ring light
- Aperture diaphragm is optional for large depth of field and high quality image

SPECIFICATION

Optical tube	binocular (20° inclined)
Eyepiece (wide field)	10X (view field: Ø22mm)
Objective	0.8X~8X (zoom)
Zoom ratio	1:10
Pupil distance	55~75mm
Diopter adjustment	±5 diopter (both eyepieces)
Working distance of objective	78mm
Max. workpiece height	72mm
Illumination	adjustable reflected and transmitted LED light
Power supply	110/220V, 50/60HZ
Dimension (L×W×H)	240×280×440mm
Weight	4.3kg

STANDARD DELIVERY

Main unit	1 pc
WF10X eyepiece	2 pcs
Ø100mm glass plate	1 pc
Ø100mm white/black plate	1 pc
Anti-dust cover	1 pc

OPTIONAL ACCESSORY

Objective	0.5X achromatic objective (focus distance: 186mm)	ISM-ZS200-OB05X *
	2X plan achromatic objective (focus distance: 32.5mm)	ISM-ZS200-OB2X
	0.5X plan apochromatic objective (focus distance: 126mm)	ISM-ZS200-APO05X *
Eyepiece	WF15X (view field: Ø16mm)	ISM-ZS200-EP15X
	WF20X (view field: Ø12mm)	ISM-ZS200-EP20X
	WF30X (view field: Ø20mm)	ISM-ZS200-EP30X
Sleeve for objective		ISM-ZS30-ADAPTER
Iris diaphragm		ISM-ZS200-IRD
Optical path splitter		ISM-ZS200-OBS
Coaxial illumination		ISM-ZS200-COAXIAL
Digital camera **		ISM-CM20, ISM-CM63

* 0.5X achromatic objective must be used with sleeve ISM-ZS30-ADAPTER

** Digital camera must be used with optical path splitter

LARGE ZOOM RATIO

ZOOM STEREO MICROSCOPES (ADVANCED TYPE)

application
(code: **ISM-ZS100T**)

connect to
digital camera



LED ring light (optional)



ISM-ZS100T

SPECIFICATION

Code	ISM-ZS100	ISM-ZS100T
Optical tube	binocular	trinocular
Eyepiece (wide field)	10X (view field: Ø23mm)	
Objective	0.6X~5X (zoom)	
Zoom ratio	1:8.3	
Pupil distance	55~75mm	
Diopter adjustment	±5 diopter (two eyepieces)	
Working distance of objective	115mm	
Max. workpiece height	75mm	
Illumination	adjustable reflected and transmitted LED light	
Power supply	110/220V, 50/60HZ	
Dimension (L×W×H)	260×310×490mm	
Weight	4.9kg	

STANDARD DELIVERY

Main unit	1 pc
Digital camera adapter 0.55X for ISM-ZS100T	1 pc
WF10X eyepiece	2 pcs
Ø100mm glass plate	1 pc
Ø100mm white/black plate	1 pc
Anti-dust cover	1 pc

OPTIONAL ACCESSORY

Auxiliary objective	0.5X (focus distance: 220mm)	ISM-ZS100-OB05X *
	0.7X (focus distance: 125mm)	ISM-ZS100-OB07X
	2X (focus distance: 45mm)	ISM-ZS100-OB2X
Eyepiece	WF15X (view field: Ø16mm)	ISM-ZS100-EP15X
	WF20X (view field: Ø12mm)	ISM-ZS100-EP20X
	WF30X (view field: Ø8mm)	ISM-ZS100-EP30X
Sleeve for auxiliary objective		ISM-ZS30-ADAPTER
LED ring light		ISM-ZS-RL
Digital camera adapter 1X for ISM-ZS100T		ISM-ZS100-DA
Digital camera for ISM-ZS100T		ISM-CM20, ISM-CM63, ISM-ZS70-S

* 0.5X auxiliary objective must be used with sleeve ISM-ZS30-ADAPTER

ZOOM STEREO MICROSCOPES (STANDARD TYPE)



LED ring light (optional)

ISM-ZS50

SPECIFICATION

Code	ISM-ZS50	ISM-ZS50T
Optical tube	binocular	trinocular
Eyepiece (wide field)	10X (view field: Ø22mm)	
Objective	0.8X~5X (zoom)	
Zoom ratio	1:6.3	
Pupil distance	55~75mm (adjustable)	
Diopter adjustment	±5 diopter (two eyepieces)	
Working distance of objective	115mm	
Max. workpiece height	215mm	
Illumination	adjustable reflected and transmitted LED light	
Power supply	110/220V, 50/60HZ	
Dimension (L×W×H)	290×260×480mm	
Weight	4.9kg	

STANDARD DELIVERY

Main unit	1 pc
WF 10X eyepiece	2 pcs
Ø100mm glass plate	1 pc
Ø100mm white/black plate	1 pc
Anti-dust cover	1 pc

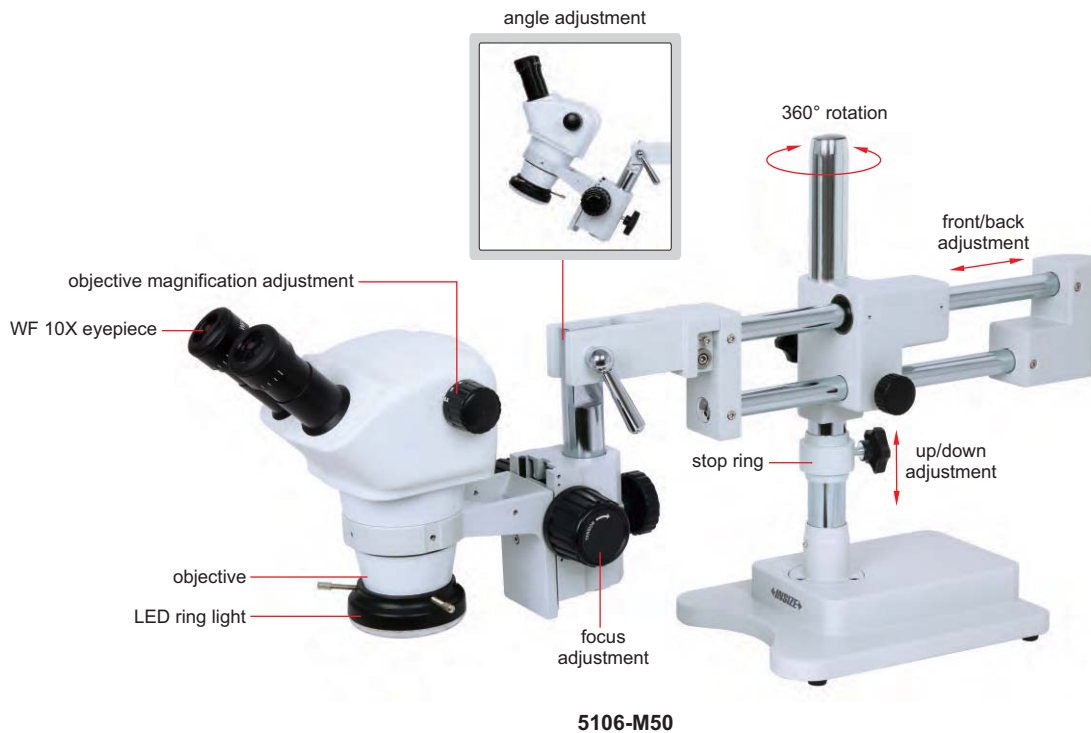
OPTIONAL ACCESSORY

Auxiliary objective	0.5X	ISM-ZS50-OB05X*
	2X	ISM-ZS50-OB2X
Eyepiece	10X dividing eyepiece (graduation 0.1mm/div.)	ISM-ZS50-EPD10X
	WF15X (view field: Ø16mm)	ISM-ZS50-EP15X
	WF20X (view field: Ø12mm)	ISM-ZS50-EP20X
LED ring light		ISM-ZS-RL
Sleeve for auxiliary objective		ISM-ZS30-ADAPTER
Digital camera for ISM-ZS50T		ISM-CM20, ISM-CM63, ISM-ZS70-S
Camera adapter 0.5X for ISM-ZS50T **		ISM-MAS-ADAPTER

* 0.5X auxiliary objective must be used with ISM-ZS30-ADAPTER

** Digital camera must be used with camera adapter 0.5X

ZOOM STEREO MICROSCOPES (WITH UNIVERSAL STAND)



SPECIFICATION

Code	5106-M50	5106-M50T
Optical tube	binocular	trinocular
Eyepiece (wide field)	10X (view field: Ø22mm)	
Objective	0.8X~5X (zoom)	
Zoom ratio	1:6.3	
Pupil distance	55~75mm	
Diopter adjustment	±5 diopter (two eyepieces)	
Working distance of objective	115mm	
Max. workpiece height	300mm	
Illumination	adjustable reflected LED ring light	
Power supply	power adapter	
Dimension (L×W×H)	790×230×430mm	
Weight	20kg	

STANDARD DELIVERY

Main unit (with stand)	1 pc
WF10X eyepiece	2 pcs
LED ring light	1 pc
Anti-dust cover	1 pc

OPTIONAL ACCESSORY

Auxiliary objective	0.5X	ISM-ZS50-OB05X *
	2X	ISM-ZS50-OB2X
Eyepiece	10X dividing eyepiece (0.1mm/div.)	ISM-ZS50-EPD10X
	WF15X (view field: Ø16mm)	ISM-ZS50-EP15X
	WF20X (view field: Ø12mm)	ISM-ZS50-EP20X
Sleeve for auxiliary objective		ISM-ZS30-ADAPTER
Digital camera for 5106-M50T		ISM-CM20, ISM-CM63, ISM-ZS70-S
Camera adapter 0.5X for 5106-M50T **		ISM-MAS-ADAPTER

* 0.5X auxiliary objective must be used with ISM-ZS30-ADAPTER

** Digital camera must be used with camera adapter 0.5X

ZOOM STEREO MICROSCOPE (BASIC TYPE) CODE ISM-ZS30



SPECIFICATION

Optical tube	binocular
Eyepiece (wide field)	10X (view field: Ø20mm)
Objective	1X~4.5X (zoom)
Zoom ratio	1:4.5
Pupil distance	55~75mm (adjustable)
Diopter adjustment	±5 diopter (two eyepieces)
Working distance of objective	97mm
Max. workpiece height	147mm
Illumination	adjustable reflected and transmitted LED light
Power supply	110/220V, 50/60HZ
Dimension (L×W×H)	260×190×400mm
Weight	4.3kg



LED ring light (optional)

STANDARD DELIVERY

Main unit	1 pc
WF 10X eyepiece	2 pcs
Ø95mm glass plate	1 pc
Ø95mm white/black plate	1 pc
Anti-dust cover	1 pc

OPTIONAL ACCESSORY

Auxiliary objective	0.5X	ISM-ZS30-OB05X *
	0.63X	ISM-ZS30-OB06X *
	0.75X	ISM-ZS30-OB07X *
	2X	ISM-ZS30-OB2X
Eyepiece	10X dividing eyepiece (graduation 0.1mm/div.)	ISM-ZS30-EPD10X
	WF15X (view field: Ø16mm)	ISM-ZS50-EP15X
	WF20X (view field: Ø12mm)	ISM-ZS50-EP20X
LED ring light		ISM-ZS-RL
Sleeve for auxiliary objective		ISM-ZS30-ADAPTER
Digital camera		ISM-CM63
Camera adapter 0.75X **		ISM-AD-0D75

* 0.5X, 0.63X and 0.75X auxiliary objectives must be used with ISM-ZS30-ADAPTER

** Digital camera must be used with camera adapter 0.75X

LONG WORKING DISTANCE STEREO MICROSCOPE (LOW MAGNIFICATION) CODE 5305-ZS80



SPECIFICATION

Magnification	8X
Eyepiece (wide field)	10X (view field: Ø20mm)
Objective	0.8X
Pupil distance	55~75mm
Diopter adjustment	±5 diopter (one eyepiece)
Working distance of objective	115mm
Max. workpiece height	100mm
Dimension (L×W×H)	280×160×370mm
Weight	3.7kg

STANDARD DELIVERY

Main unit	1 pc
10X eyepieces	1 pair
0.8X objective	1 pc
Anti-dust cover	1 pc

OPTIONAL ACCESSORY

Eyepiece	WF5X (view field: Ø20mm)	5305-ZS80-EP5X
	WF15X (view field: Ø15mm)	5305-ZS80-EP15X
	WF20X (view field: Ø10mm)	5305-ZS80-EP20X
LED ring light		ISM-ZS-RL



LED ring light (optional)

POLARIZING MICROSCOPE CODE ISM-POL1000



- Widely used in geology, mineralogy, fossil fuel exploration
- Single polarization, orthogonal polarization or conoscopic observation are available



SPECIFICATION

Magnification	40X~600X				
Eyepiece	10X (view field: \varnothing 20mm)				
Infinite strain free plan achromatic objective	4X (transmitted/reflected)	10X (transmitted/reflected)	20X (transmitted)	40X (transmitted)	60X (transmitted)
Working distance	22.2mm	6.1mm	6.4mm	0.6mm	0.3mm
Numerical aperture	0.1	0.25	0.4	0.65	0.8
Stage	revolving round stage				
	diameter: \varnothing 160mm				
	graduation: 1°, resolution: 6'				
Pupil distance	53~75mm				
Diopter adjustment	\pm 5 diopter (one eyepiece)				
Illumination	12V/50W halogen lamp, brightness is adjustable (reflected illumination)				
	12V/20W halogen lamp, brightness is adjustable (transmitted illumination)				
Power supply	110/220V, 50/60HZ				
Dimension (L×W×H)	614×250×394mm				
Weight	13kg				

STANDARD DELIVERY

Main unit	1 pc
Micrometer	1 pc
Grid plate	1 pc
10X crossing eyepiece (view field: \varnothing 20mm)	1 pc
10X dividing eyepiece (view field: \varnothing 20mm, graduation 0.1mm)	1 pc
λ slip (first class red) and 1/4 λ slip	1 pc
Quartz wedge	1 pc

OPTIONAL ACCESSORY

Objective for reflected system	PL20X	ISM-POL1000-OBR20X
	PL40X	ISM-POL1000-OBR40X
	PL60X	ISM-POL1000-OBR60X
	PL100X	ISM-POL1000-OBR100X
Objective for transmitted system	PL100X	ISM-POL1000-OBT100X
Specimen presser		ISM-POL1000-SP

DIGITAL CAMERA FOR MICROSCOPES CODE ISM-CM63

ATTENTION: ADAPTERS ARE NEEDED
ACCORDING TO MICROSCOPES



- To be used with computers
- Sony Exmor back-illuminated CMOS sensor
- USB3.0 transmission
- Automatic exposure, gain adjustment, white balance, chrominance adjustment, saturation adjustment, gamma correction, luminance adjustment, contrast adjustment



C-mount port

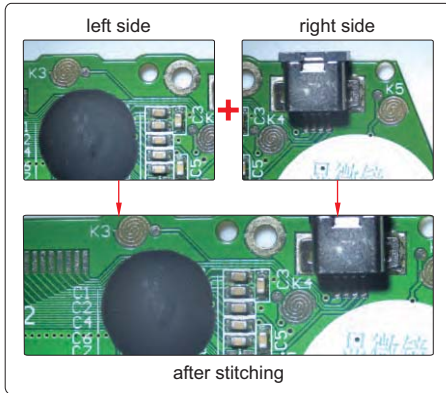
adapter 0.75X
(optional)



application



automatic image stitching (expand field of view)



software (included)

selectable resolution

histogram (quantify the distribution of color and brightness)

black balance (reduce color difference)

measurement items

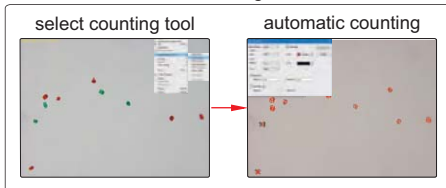
flat field correction (reduce brightness difference)

real time gray calibration

dark field correction (reduce thermal noise)

The software can control image completely, including measurement, image stitching, extend focus depth, image gray processing, RGB histogram observation, image color sampling, 3D plot (3D representation of image intensity), image exposure, white balance, black balance, image bit depth, flat field correction and dark field correction, etc.

counting



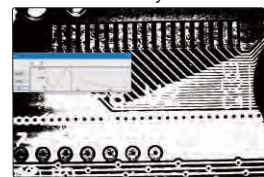
focus stacking



Measuring tools:

- | | |
|---|--|
| measure length of line or distance between two points | measure rectangle |
| measure distance between two parallel lines | measure width and diameter of ring |
| measure angle | measure diameter, length, perimeter angle of arc |
| measure radius, girth and area of circle | measure area of polygon |
| measure axis lengths, girth and area of ellipse | measure center distance between two circles |
| calibration | measure length of open curve |

Binary



separate target and background

3D plot



Visualize the distribution of image brightness and color

To be continued

Continued from previous page

SPECIFICATION

Sensor (back-up)	1/1.8" CMOS
Resolution	3072×2048
Pixel	6.3M
Single pixel size	2.4×2.4μm
Spectral range	380-650nm (with infrared cut filter)
Frame rate	30fps
Sampling average	1×1
Exposure time	0.1ms~15s
Power supply	USB port
Weight	400g

STANDAER DELIVERY

Camera (USB cable included)	1 pc
Software	1 pc

COMPUTER REQUIREMENT

Operation system	Windows/7/8/10
CPU	Intel Core 2 2.8Hz or above
Memery	2GB or above
USB port	USB3.0 (recommand) or USB2.0
Display	17" or above

OPTIONAL ACCESSORY

Adapter 0.75X	ISM-AD-0D75
---------------	-------------

SMART CAMERA CODE ISM-MV10



- Built-in software, operated by mouse.
- Automatically calculate, store the test results and export to Excel.
- Camera with PLC control input and output interface, can be integrated with automation equipment.
- Functions: presence or absence of objects, position tilt correction, object counting, color detection, stain detection, dimension measurement, position guide, etc.

SPECIFICATION

Chip structure	FPGA+ARM
Opreating system	Linux 3.10
Kernel structure	dual-core Cortex-A9
Frequency	1GHZ
I/O port	3 sets of input and output (can be connected to photoelectric switch, wire switch, PLC, etc.)
Working temperature	-10~70°C
Sensor	1/2" CMOS
Single pixel size	3.75×3.75μm
Resolution	1920×1080
Frame rate	60fps
Video output	HDMI port
Lens connection	standard C port

SOFTWARE

presence or absence of objects



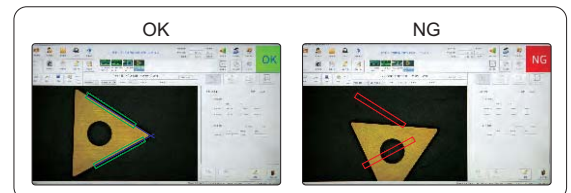
select the area and specify the target, the camera will automatically detect the presence or absence of the target.

automatic counting



select the area and specify the target, the camera will automatically calculate the number of targets.

dimension measurement



measuring angle, distance, radius, center distance, etc.

STANDAER DELIVERY

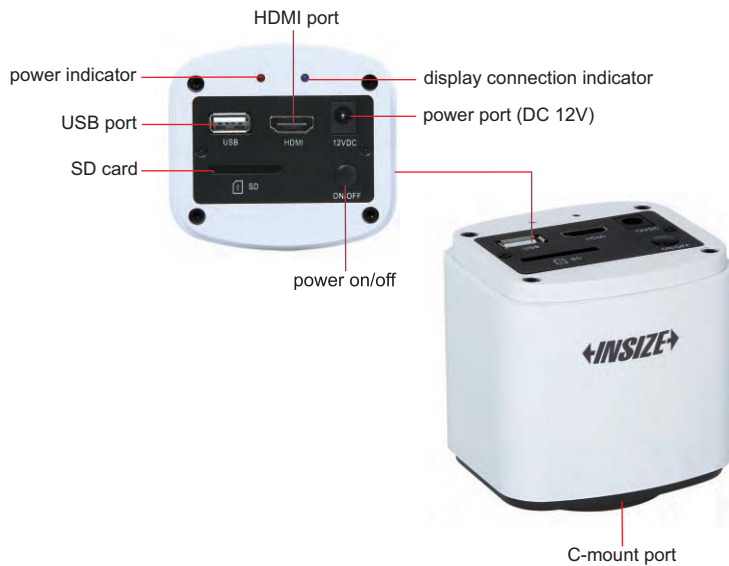
Camera (with HDMI cable)	1 pc
Software	1 pc

DIGITAL CAMERA FOR MICROSCOPES CODE ISM-CM20

ATTENTION: ADAPTERS ARE NEEDED
ACCORDING TO MICROSCOPES

FOCUS
STACKING

AUTOMATIC IMAGE
STITCHING



adapter 0.5X (optional)



application

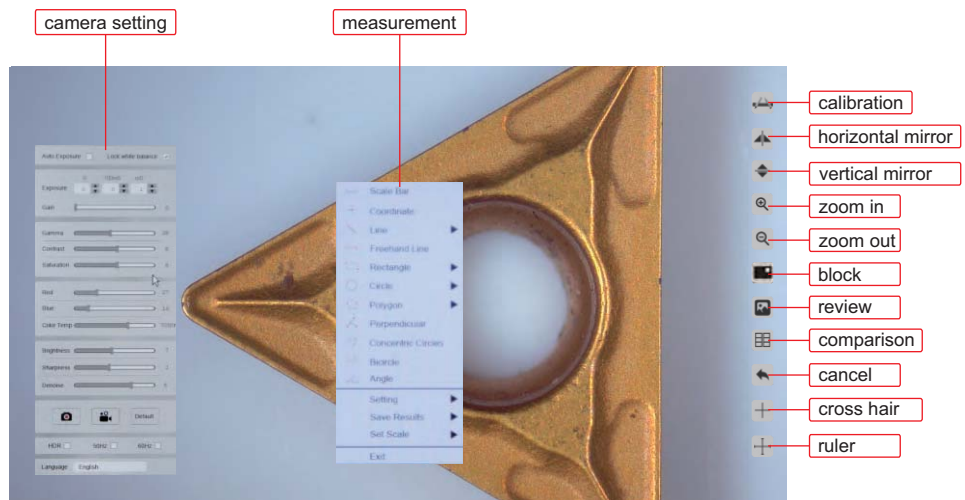


- 1080P high-definition image
- Can be connected with displays or computers
- Built-in simple measuring software for displays, without computer
- Professional measuring software for computers is included
- For bright field, dark field or fluorescent field
- Automatic exposure, white balance, gain adjustment, gamma correction, brightness contrast adjustment, saturation adjustment, chroma sharpness adjustment
- Focus stacking, automatic image stitching

SIMPLE MEASURING SOFTWARE (BUILT-IN, FOR DISPLAYS)

Measuring tools:

- measure length of line or distance between two points
- measure distance between point and line
- measure rectangle
- measure concentric circles
- measure circle
- measure curve
- measure polygon
- measure center distance of two circles
- measure angle of two lines




Auto exposure, white balance, gain adjustment, gamma, chroma contrast adjustment, brightness sharpness adjustment, size measurement

To be continued

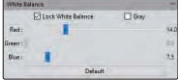
continued from previous page

PROFESSIONAL MEASURING SOFTWARE (INCLUDED, FOR COMPUTERS)

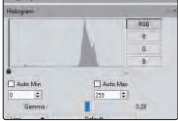
selectable resolution



white balance
(balance color based on actual light source)



histogram
(quantify the distribution of color and brightness)



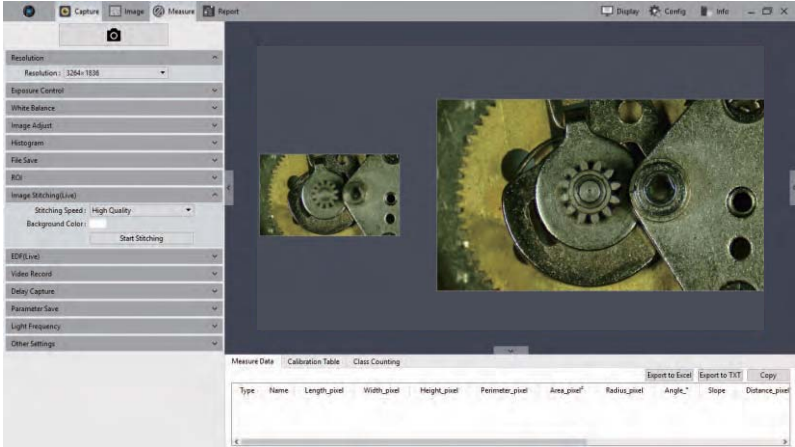
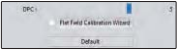



Image coloring, fluorescence synthesis, binary, image smoothing, color filter/color extraction/color inversion, delay capture, focus stacking, automatic image stitching, metrics flow, manual counting, dynamic and static measurement, layered measurement, report generation and printing, delay record, flat field correction, image adjustment, histogram.

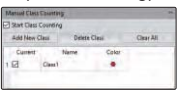
flat field correction






metrics flow
(create templates, set tolerances and build metrics flow)



manual counting
(class counting)



focus stacking





+

→


focus on the top

focus on the bottom

clear image of both top and bottom

automatic image stitching


+

→


slowly move the workpiece to generate a stitched image automatically (this image can not be used for size measurement)

SPECIFICATION

Sensor	1/2.8" CMOS
Pixel	2M
Resolution	1920×1080
Frame rate	30fps
Power supply	power adapter
Output	HDMI/USB
Lens connection	C-mount

COMPUTER (optional) REQUIREMENT

Operation system	Windows 7/8/10 (64 bit)
CPU	Intel Core i5 or above
Memory	8GB or above
USB port	USB 3.0

DISPLAY (optional) REQUIREMENT

Size	13" or above
Resolution	1080P or above
HDMI port	TYPE A

STANDARD DELIVERY

Main unit	1 pc
16G memory card and holder	1 pc
Mouse	1 pc
HDMI cable	1 pc
USB cable	1 pc
Power supply	1 pc

OPTIONAL ACCESSORY

Adapter 0.5X	ISM-MAS-ADAPTER
--------------	-----------------

METALLURGICAL ANALYSIS SOFTWARE AND CAMERA CODE ISM-MAS100

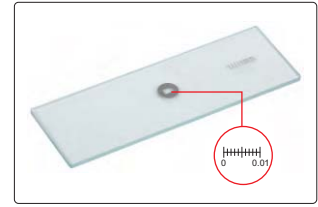
- More than 100 standards (ISO, ASTM, JIS, etc.)
- For metallurgical microscopes
- The camera can be inserted into the eyepiece tube or camera connector of microscopes
- Metallurgical analysis software is included, which can make comparative analysis, measurement and evaluation of various materials



application



software CD (included)



glass calibration rule (included, graduation 0.01mm)

metallurgical analysis software (included)

tool bar

gallery

This software can be used with variety of metallurgical microscopes for acquisition, processing, analysis, report generation of metallurgical images

metallurgical module list

Select autoAnalysis item

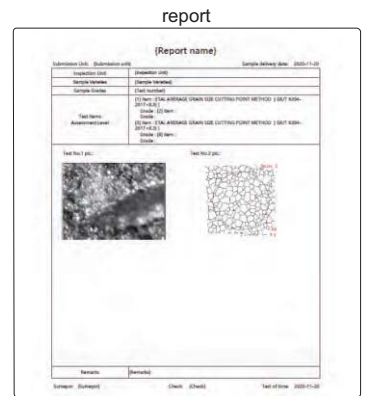
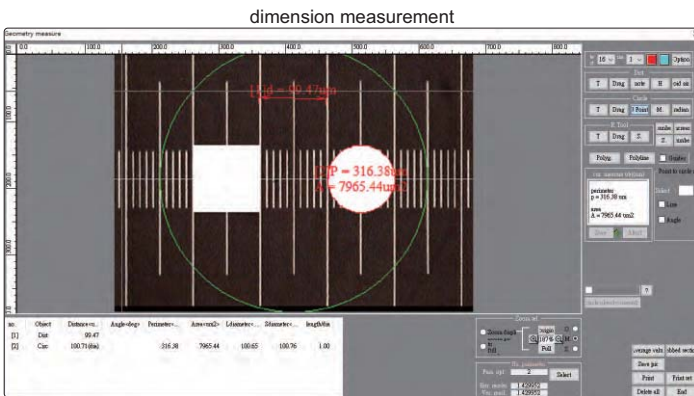
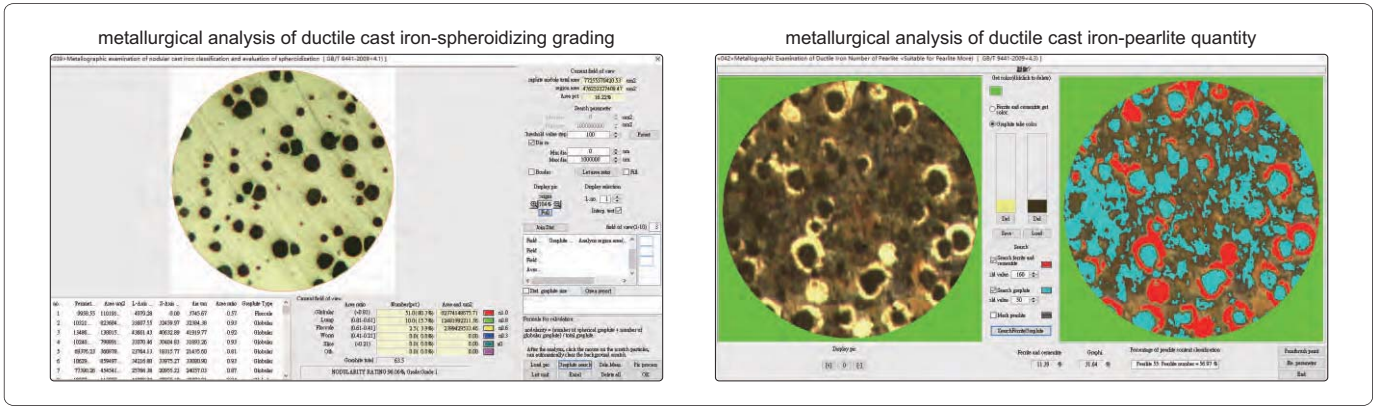
- [001] METHOD OF AVERAGE GRAIN SIZE AREA OF METAL
- [003] METHOD OF AVERAGE GRAIN SIZE AREA OF METAL
- [002] METAL AVERAGE GRAIN SIZE CUTTING POINT METHOD
- [002] METAL AVERAGE GRAIN SIZE COMPARISON METHOD
- [004] Details of Average Grain Size Testing for Other Metals and Alloys
- [005] Standard for Dual Grain Size Characterization Test Method Area Fraction Evaluation Comparison Chart
- [006] Standard for Dual Grain Size Characterization Test Method_M1_Micrographs of Dual Grain Size Types
- [007] Standard for Dual Grain Size Characterization Test Method_M1_Micrographs of Dual Grain Size Types
- [008] Standard for Dual Grain Size Characterization Test Method_M2_Application of Statistical Program for Determining Grain Size Distribution
- [009] steel apparent grain size of micrographic estimating(automated) EN
- [010] steel apparent grain size of micrographic estimating(transversal method) EN
- [011] Determination of nonmetallic inclusion content in steel by standard grading diagram
- [012] Evaluation Method of Inclusion Content in Steel_method (short field of view method)
- [013] Evaluation Method of Inclusion Content in Steel_method (Low Inclusion Content Method)
- [014] Evaluation Method of Inclusion Content in Steel_method
- [015] Metallurgical examination method. Microscopic examination of non-metallic inclusions in high quality steel by metallurgical diagram
- [016] Metallurgical examination of precious metal cuprous oxide
- [017] Determination of decarburization depth of steel
- [018] DETERMINATION OF FERRITIC GRAIN SIZE OF LOW CARBON STEEL COIL ROLLED SHEET GRAIN ELONGATION
- [019] Determination of Phase Area Content of Stainless Steel
- [020] Metallurgical Examination of Gray Cast Iron Graphite Distribution Shape
- [021] Metallurgical Examination of Gray Cast Iron Graphite Length (Manual Analysis)
- [022] Metallurgical Examination of Gray Cast Iron Graphite Length (Automatic Analysis)
- [023] Metallurgical Examination of Gray Cast Iron Number of Pearlite
- [024] Metallurgical Examination of Gray Cast Iron Number of Carbides
- [025] Metallurgical Examination of Gray Cast Iron Number of Phosphorus Eutectic
- [026] Metallurgical Examination of Gray Cast Iron Determination of the Number of Eutectic Groups of Cast Iron
- [027] Metallurgical examination of gray cast iron Phosphorus eutectic type etc.
- [028] Quantitative metallurgical determination
- [029] Free cementite
- [030] Ferrite in Low Carbon Deformed Steel
- [031] Pearl tissue
- [032] Microstructure Assessment of Steel Calculation of Trasnite Content
- [033] Microstructure Assessment of Steel Calculation of Trasnite Content
- [034] Metallurgical Retained Austenite Needle Length Rating of Carburized Gear For Automobile
- [035] Metallurgical Retained Austenite Rating of Carburized Gears For Automobile
- [036] Metallurgical Retained Austenite Rating of Carburized Gears For Automobile

Multi-module grad [F5] OK Cancel

To be continued

Continued from previous page

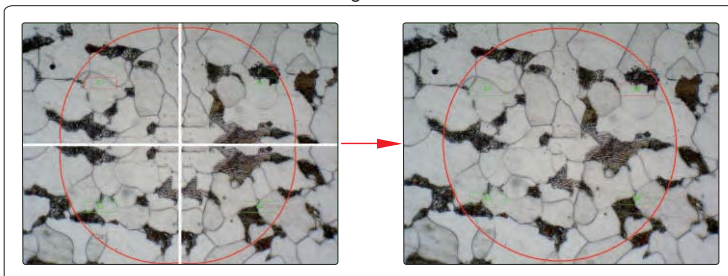
examples of metallurgical analysis



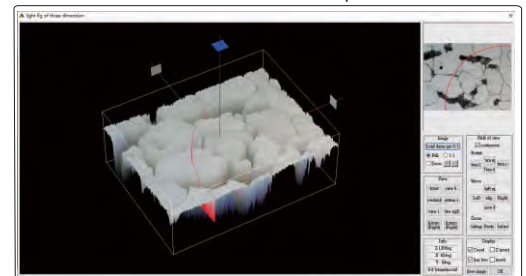
focus stacking



image stitch



three dimension map



SPECIFICATION

Sensor	1/2" CMOS
Pixel	3M
Resolution	2048x1536
Frame rate	6fps
Exposure	manual or automatic, adjustable exposure time
Power supply	USB port
Weight	400g

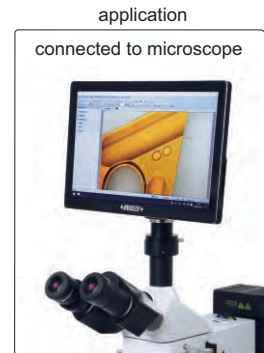
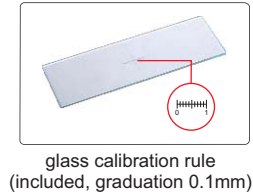
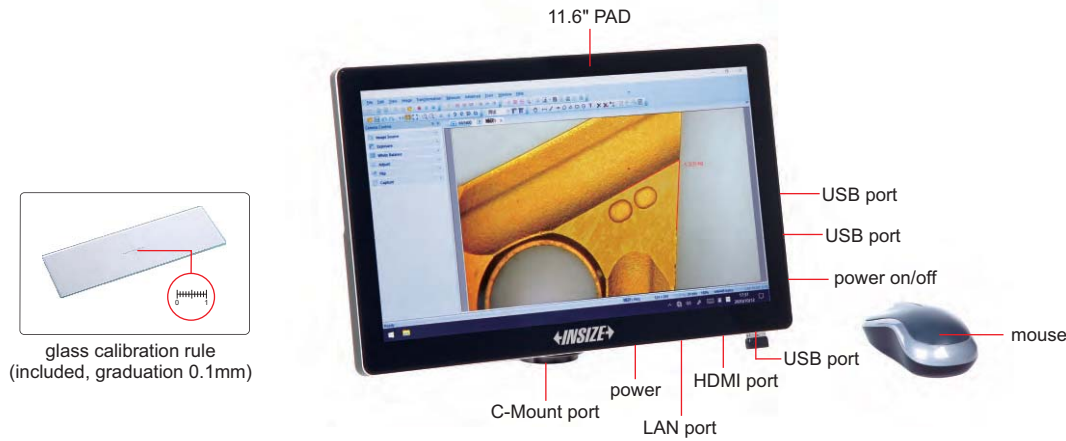
STANDAER DELIVERY IS

Camera (USB cable included)	1 pc
Software	1 pc
Glass calibration rule (graduation 0.01mm)	1 pc

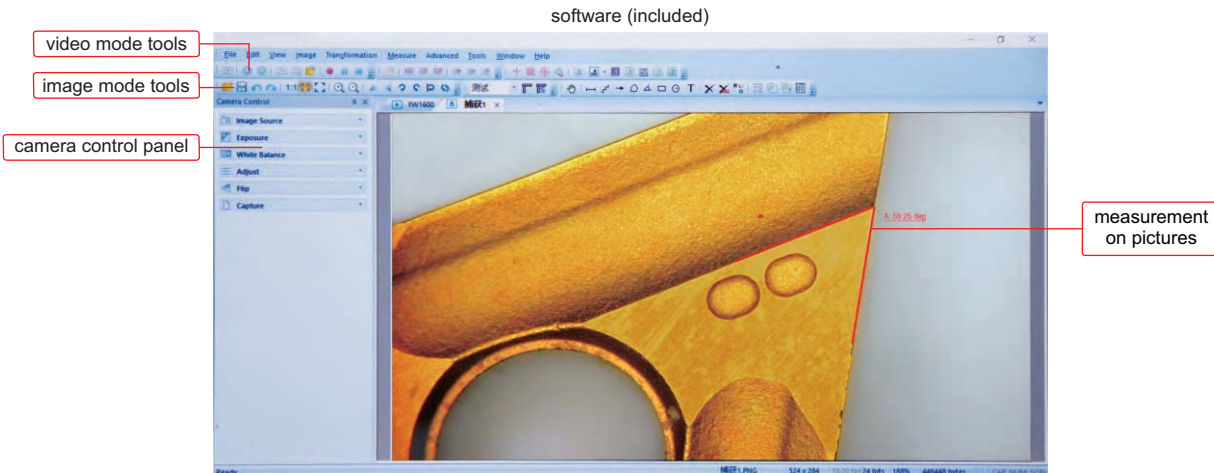
DIGITAL CAMERA FOR MICROSCOPES (WITH PAD) CODE ISM-ZS70-S

ATTENTION: CAMERA CONNECTOR AND ADAPTER ARE NEEDED ACCORDING TO MICROSCOPES

MEASUREMENT, TAKE PICTURES AND VIDEOS



- Windows 10 operation system
- Built-in software, can take pictures and videos, can measure
- Language: Chinese, English, French, Japanese, German, Polish, Arabic
- Automatic exposure, white balance, brightness, contrast ratio, saturation are adjustable
- Image process feature: zoom in/out, flip, mirror, stitching and so on
- Output to Excel or CSV file



Measuring tools

- measure line
- measure meander line
- arrow mark
- measure polygon
- calibration
- measure angle
- measure rectangle
- measure circle
- text mark
- show/hide scale

SPECIFICATION

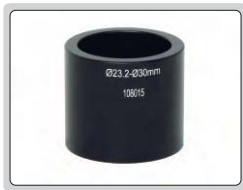
Sensor	1/2.3" CMOS
Pixel	16M
Resolution	800×600, 1600×1200, 1920×1080, 2048×1536, 2304×1728, 2592×1944, 4608×3456
Frame rate	30fps (1920×1080)
Output	HDMI, USB 3.0
Power supply	power adapter
Dimension (L×W×H)	280.3×177.4×12.5mm
Weight	0.9kg

STANDARD DELIVERY

Main unit	1 pc
Mouse	1 pc
Glass calibration rule (graduation 0.1mm)	1 pc
AC/DC adapter	1 pc

CAMERA ADAPTERS

- Ø23.2/30mm eyepiece adapter is included
- Suitable for digital cameras ISM-CM20, ISM-CM63, ISM-ZS70-S



Ø23.2/30mm eyepiece adapter (included)



0.5X camera adapter (fixed focus distance) ISM-AD-0D5



0.75X camera adapter (fixed focus distance) ISM-AD-0D75



0.5X camera adapter (adjustable focus distance) ISM-AD-A0D5



0.75X camera adapter (adjustable focus distance) ISM-AD-A0D75



SPECIFICATION

Code	ISM-AD-0D5	ISM-AD-A0D5 *	ISM-AD-0D75	ISM-AD-A0D75
Type	fixed focus distance	adjustable focus distance	fixed focus distance	adjustable focus distance
Magnification	0.5X	0.41X~0.58X	0.75X	0.64X~0.86X

* There may be shadows on the edge of image when ISM-AD-A0D5 is used

PORTABLE MEASURING MICROSCOPES

17

SPECIFICATION

Code	ISM-PM20	ISM-PM40	ISM-PM50	ISM-PM100
Total magnification	20X	40X	50X	100X
Eyepiece	10X with graduation	10X with graduation	10X with graduation	10X with graduation
Objective (achromatic)	2X (numerical aperture: 0.05)	4X (numerical aperture: 0.1)	5X (numerical aperture: 0.12)	10X (numerical aperture: 0.25)
Working distance	17.2mm	18mm	17.6mm	7mm
Graduation	0.05mm	0.025mm	0.02mm	0.01mm
Viewing field	Ø9mm	Ø4.5mm	Ø3.6mm	Ø1.8mm
Focus range	30mm			
Illumination	LED light			
Diameter of base	Ø63mm			
Height	210mm			
Weight	650g			



ISM-PM100

STANDARD DELIVERY

Main unit	1 pc
Pen light	1 pc
Battery (AAA)	2 pcs

TABLE MAGNIFIER WITH ILLUMINATION CODE 7517-3D

- Four steps brightness adjustment
- LED illumination, working life 20000h
- Resin lens

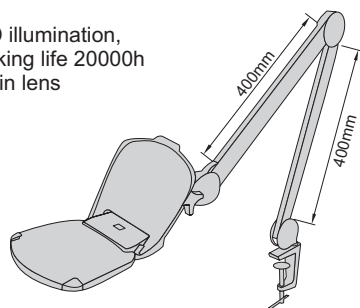
SPECIFICATION

Magnification	1.75X
Diopter	3D
Lens diameter	Ø125mm
Illumination	power: 3W, illumination: 260lm
Power supply	power adapter 12V, 1A

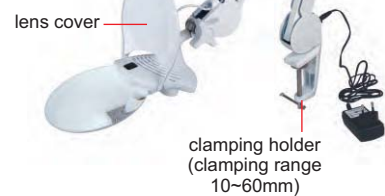


TABLE MAGNIFIERS WITH ILLUMINATION

- LED illumination, working life 20000h
- Resin lens



7520-320D



7521-3D

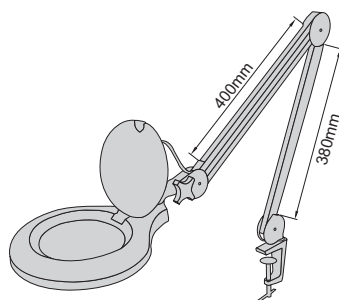
SPECIFICATION

Code	7520-320D	7521-3D
Magnification	two magnifications 1.75X/6X	1.75X
Diopter	3D/20D	3D
Lens dimension	160×127mm	Ø126mm
Illumination	power: 6W, illumination: 550lm	
Power supply	power adapter 12V, 1A	

18

TABLE MAGNIFIER WITH ILLUMINATION CODE 7516-5D

- LED illumination, working life 20000h



60 pcs LED



7516-5D

SPECIFICATION

Magnification	2.25X
Diopter	5D
Lens diameter	Ø122mm
Illumination	power: 7W, illumination: 420lm
Power supply	100~240V, 50~60Hz

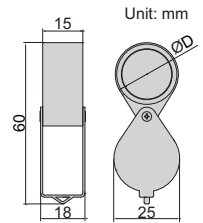
FOLDING MAGNIFIER

- Glass lens

Code	Magnification	Lens diameter (ØD)
7511-8	10X	Ø21mm



7511-8



FOLDING MAGNIFIER WITH ILLUMINATION

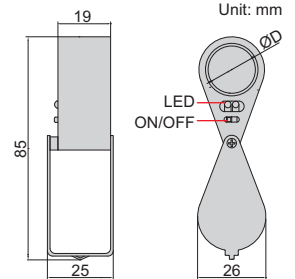


- Resin lens
- Powered by 3xLR927 batteries (included)

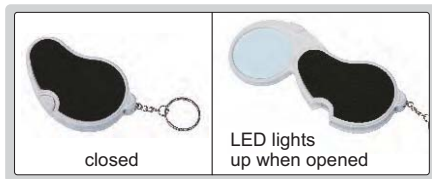
Code	Magnification	Lens diameter (ØD)
7515-10	10X	Ø21mm



7515-10



FOLDING MAGNIFIER WITH ILLUMINATION

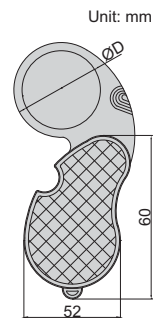


- Resin lens
- Powered by 2xCR1620 batteries (included)
- LED lights up automatically when opened

Code	Magnification	Lens diameter (ØD)
7514-1	2.5X	Ø45mm

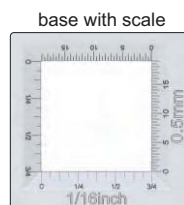


7514-1



MAGNIFIER WITH ILLUMINATION

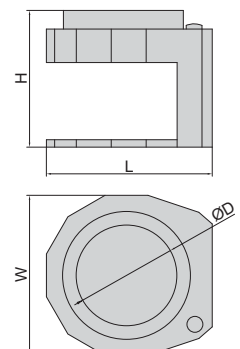
- Glass lens
- Powered by 3xAG7 batteries
- 3 pcs LED and 3 pcs UV
- Base with scale, graduation: 0.5mm, 1/16"



rotate lens to adjust focus



7524-10



Code	Magnification	Lens diameter (ØD)	L	H	W
7524-10	10X	Ø30mm	60mm	50mm	56mm

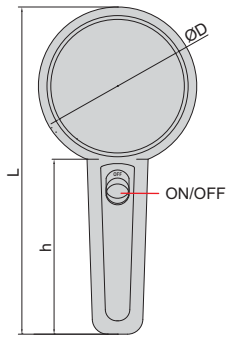
MAGNIFIERS WITH ILLUMINATION

- Glass lens
- Powered by 3xAAA batteries (included)



7513-2

7513-4



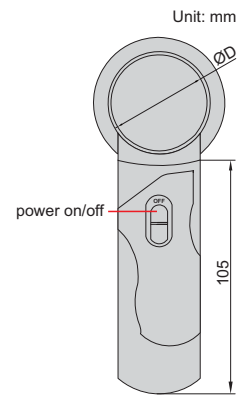
Code	Magnification	Lens diameter (ØD)	L	h
7513-2	2X	Ø75mm	170mm	90mm
7513-4	4X	Ø50mm	145mm	90mm

MAGNIFIER WITH TWO LENSES

- Resin lens
- Interchangeable lenses
- Powered by 3 pcs AAA batteries (included)



7522-610



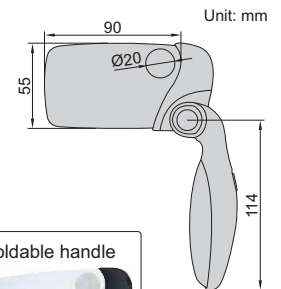
Code	Lens number	Magnification	Lens diameter (ØD)
7522-610	2 pcs	6X	50mm
		10X	37mm

MAGNIFIER WITH ILLUMINATION

- Two magnifications
- LED illumination
- Powered by 2 pcs AAA batteries (included)
- Resin lens



7518-26



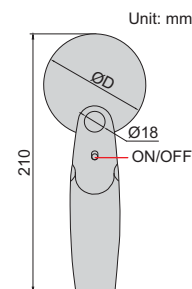
Code	Magnification	Lens size
7518-26	2X/6X	90x55mm

MAGNIFIER WITH ILLUMINATION

- Handheld and desk-type use
- Two magnifications
- LED illumination
- Powered by 2xAA batteries (included)
- Resin lens



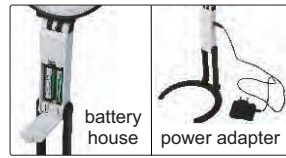
7519-26



Code	Magnification	Lens diameter (ØD)
7519-26	2X/6X	90mm

THREE WAYS MAGNIFIER WITH ILLUMINATION

- Resin lens
- Powered by 2xAA batteries (included) or power adapter (110~240V, 50~60Hz)

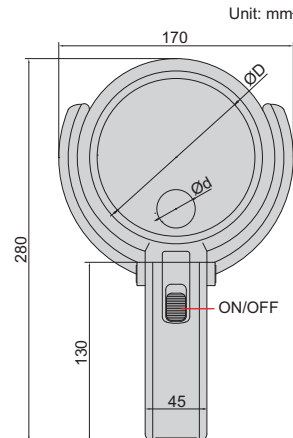


three ways use



10 pcs LED

Code	Magnification	Lens diameter (ØD)	Lens diameter (Ød)
7512-1	2X/4X	Ø120mm	Ø28mm



7512-1

MAGNIFICATION GLASSES

interchangeable lenses



head band (included)



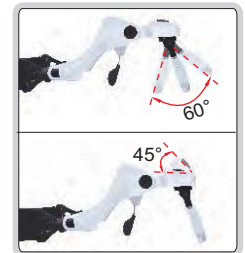
- Resin lens
- Interchangeable lenses
- Powered by 3 pcs AAA batteries (included)

Code	Lens number	Magnification
7523-3D5	5 pcs	1X
		1.5X
		2X
		2.5X
		3.5X



7523-3D5

adjustable lens and LED angle



adjustable holder angle



moveable lens for focus



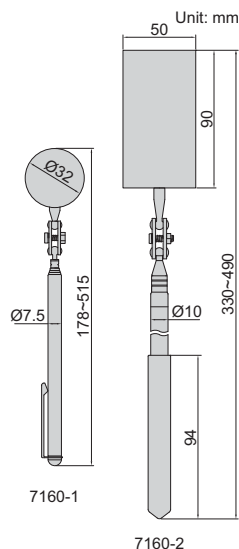
2 pcs LED



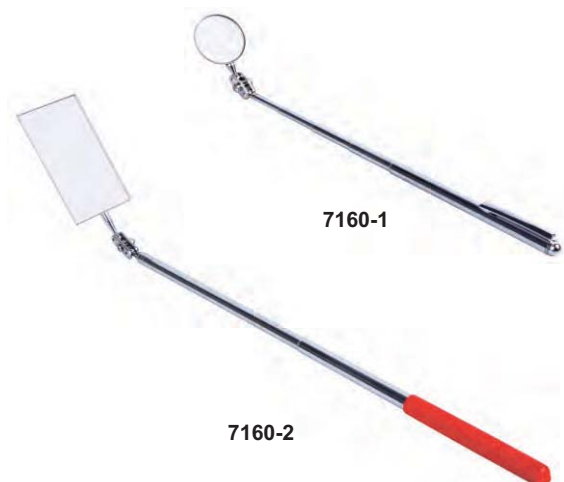
18

TELESCOPING INSPECTION MIRRORS

- Inspect hidden areas
- Rotation of the mirror: 360°
- Length of handle is adjustable, handle is made of stainless steel

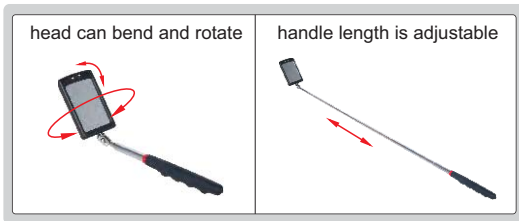


Code	Size of mirror	Length
7160-1	Ø32mm	178~515mm
7160-2	50x90mm	330~490mm



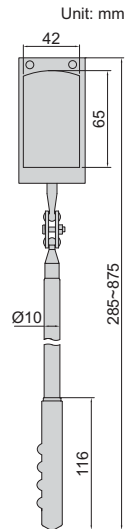
7160-2

TELESCOPING INSPECTION MIRROR (WITH ILLUMINATION)



- Inspect hidden areas
- Head can bend and rotate
- Telescoping handle, made of stainless steel
- With two CR2032 batteries

Code	Size of mirror	Length
7162-1	65x42mm	285~875mm

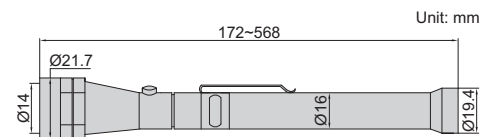


TELESCOPING MAGNETIC PICK-UP AND FLASHLIGHT

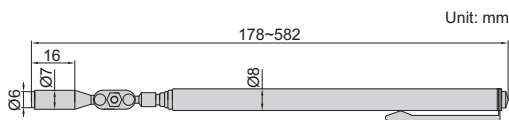


- For illumination and pick up steel parts in hidden areas
- Head can bend
- Telescoping handle, made of stainless steel
- Magnetic head and end
- With four LR44 batteries

Code	Magnetic force of the end	Magnetic force of the head	Flashlight range	Battery life	Length
7163-1	4kgf	2kgf	3m	8h	172~568mm



TELESCOPING MAGNETIC PICK-UP

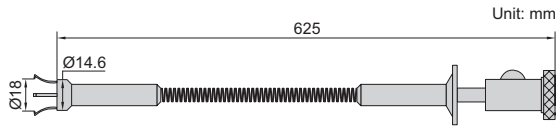


- Pick up steel parts from hidden areas
- Rotation of magnetic head: 360°
- Length of handle is adjustable, handle is made of stainless steel

Code	Size of magnetic tip	Magnetic force	Length
7161-1	Ø6mm	0.45kgf	178~582mm

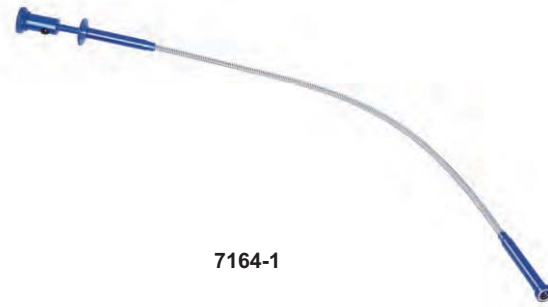


FLEXIBLE PICK-UP AND FLASHLIGHT

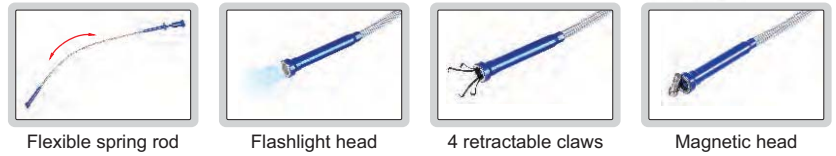


- To illumination, to pick up parts from hidden areas, or to pick up steel parts
- Flexible spring rod, made of stainless steel
- Three LR44 batteries

Code	Magnetic force	Flashlight range	Battery life
7164-1	0.9kgf	1m	24h



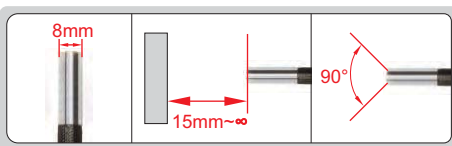
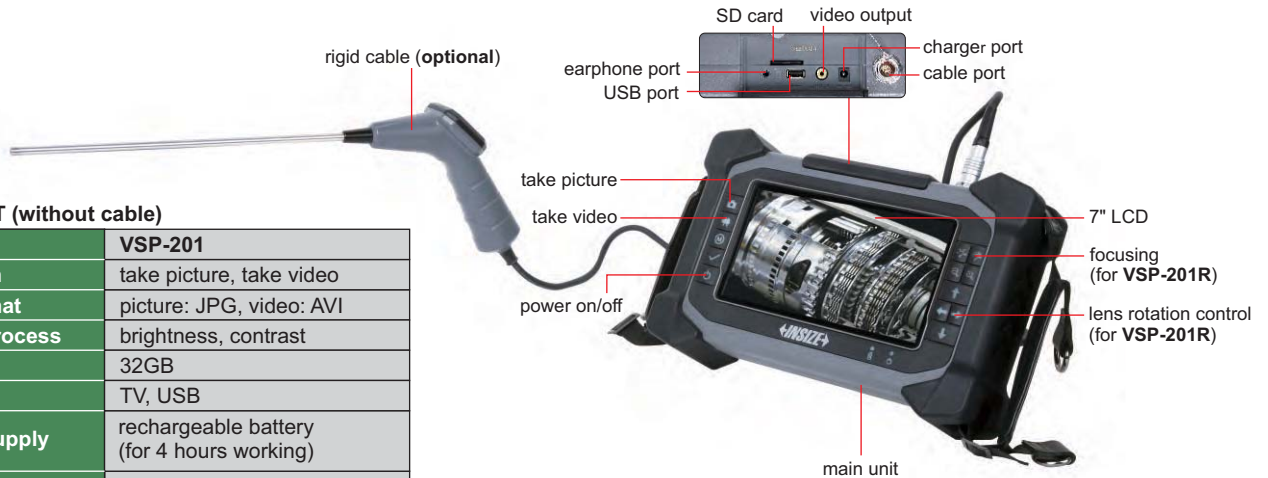
7164-1



MULTIPURPOSE VIDEOSCOPE

MAIN UNIT (without cable)

Code	VSP-201
Function	take picture, take video
File format	picture: JPG, video: AVI
Image process	brightness, contrast
Memory	32GB
Output	TV, USB
Power supply	rechargeable battery (for 4 hours working)
Dimension	260×170×65mm
Weight	1.2kg



diameter (D) focus distance (F) angle of view (θ)

FOUR-DIRECTION CABLE (FRONT VIEW)

Code	VSP-201D	
Cable	length	3m
	type	tungsten wire weaved cable
Lens	diameter (D)	8mm
	focus distance (F)	15mm~∞
	angle of view (θ)	90°
	illumination	6 pcs LED
	pixel	1M
	resolution	1280×720
dust/waterproof		IP67

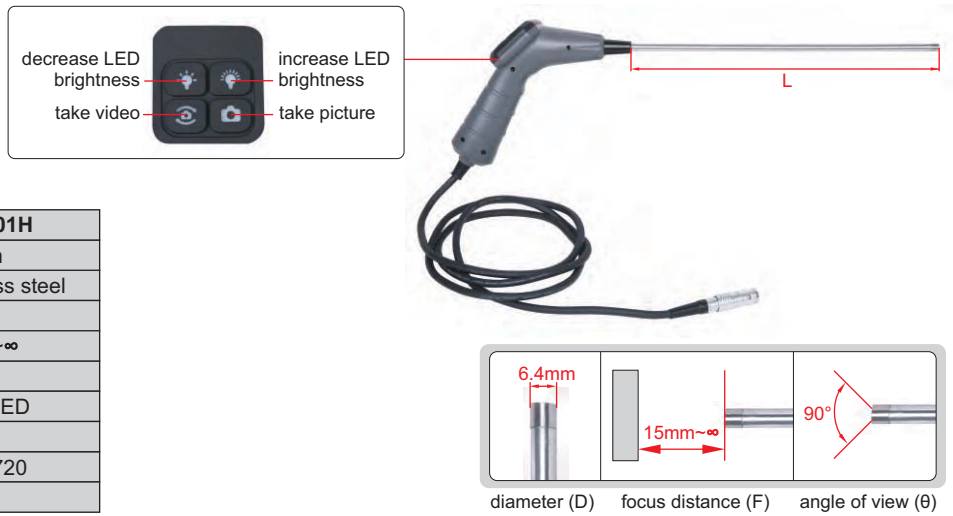


bend in any direction 360° swivel in clockwise and counter-clockwise bend within 120°



To be continued

Continued from previous page

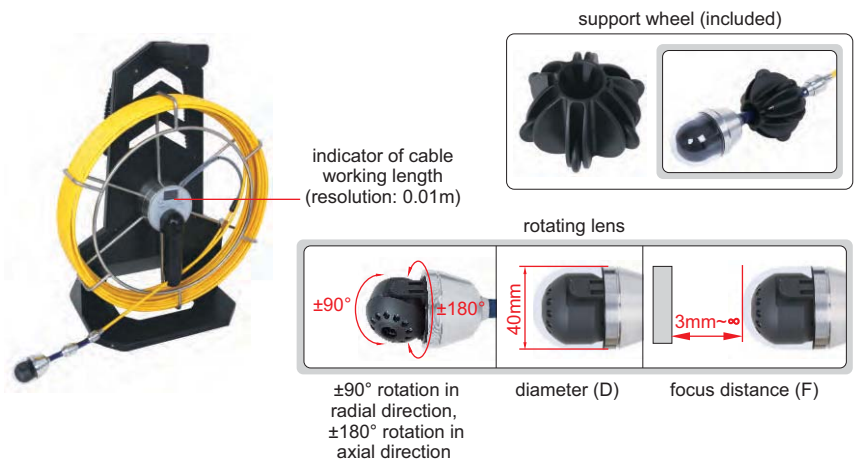


RIGID CABLE

Code		VSP-201H
Cable	length	250mm
	type	stainless steel
Lens	diameter (D)	6.4mm
	focus distance (F)	15mm~∞
	angle of view (θ)	90°
	illumination	6 pcs LED
	pixel	1M
	resolution	1280×720
	dust/waterproof	IP64

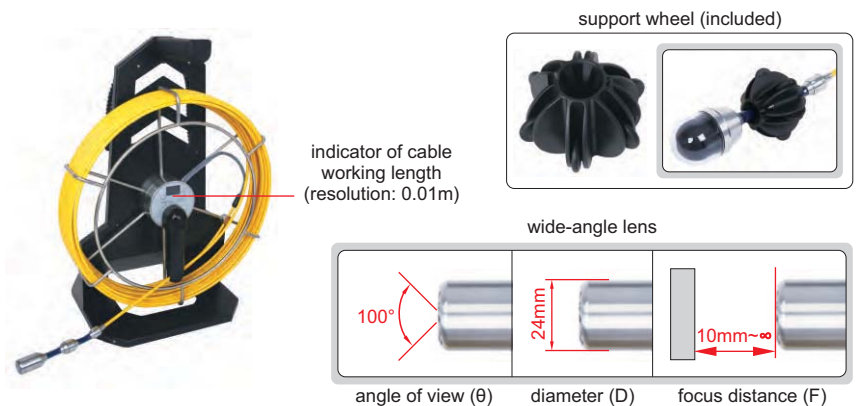
ROTATING LENS CABLE

Code		VSP-201R
Cable	length	30m
	type	high strength glass fibre
Lens	diameter (D)	40mm
	focus distance (F)	3mm~∞
	angle of view (θ)	100°
	illumination	12 pcs LED
	pixel	0.3M
	resolution	800×480
	dust/waterproof	IP67
lens control	motorized	



WIDE-ANGLE LENS CABLE

Code		VSP-201W
Cable	length	30m
	type	high strength glass fibre
Lens	diameter (D)	24mm
	focus distance (F)	10mm~∞
	angle of view (θ)	100°
	illumination	12 pcs LED
	pixel	0.3M
	resolution	800×480
	dust/waterproof	IP67



ADJUSTABLE SUPPORT

Code	Working diameter (D)	Remark
VSP-201-R200	60~200mm	for VSP-201R or VSP-201W

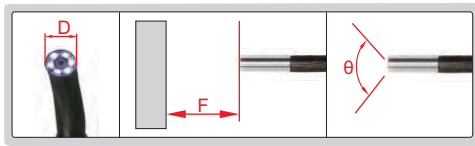


TUNGSTEN WIRE WEAVED CABLE
BREAK AND WEAR RESISTANCE

IP64
WATERPROOF

HIGH-DEFINITION 360° SWIVEL VIDEOSCOPIES

rapid change of lens cable



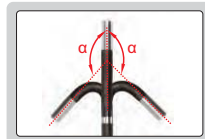
lens with LED focus distance angle of view



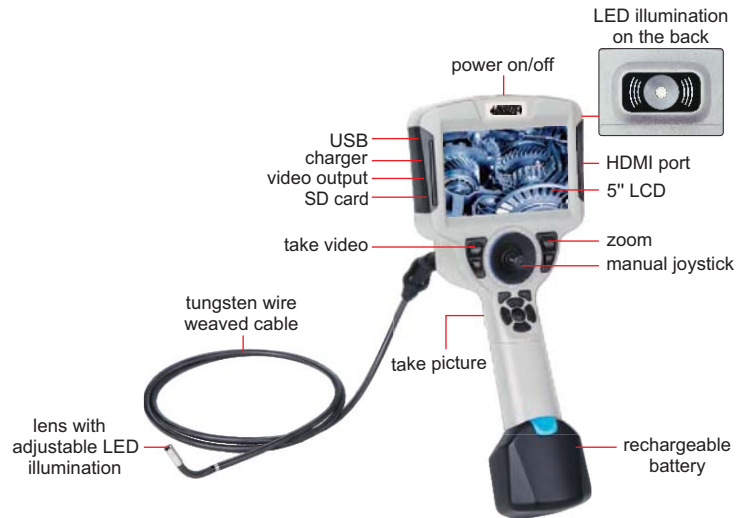
bend in any direction



360° swivel in clockwise and counter-clockwise



bend within α



ISV-MS726

SPECIFICATION

Code	ISV-MS716	ISV-MS726	ISV-MS736	ISV-MS714	ISV-MS724	ISV-MS734	
Lens	diameter (D)	6.5mm			4mm		
	lens bending range (α)	$\pm 160^\circ$			$\pm 120^\circ$		
	focus distance (F)	15mm~ ∞			8~80mm		
	viewing angle (θ)	>120°					
	illumination	6 pcs LED					
	pixel	0.92M					
	resolution	1280x720					
	dust/waterproof	IP64					
	bend control	manual joystick					
Cable	length	1m	1.5m	3m	1m	1.5m	3m
	type	tungsten wire weaved cable					
Main unit	function	take picture, take video					
	file format	picture: JPG, video: AVI					
	image process	brightness, image quality zoom (1X, 1.5X, 2X, 2.5X, 3X)					
	memory	32G SD card					
	output	TV, USB, HDMI					
	temperature sensing	display real-time temperature of the probe					
	screen rotation	180°					
power supply	rechargeable battery (for 4 hours working) AC/DC adapter (for continuous working)						
Weight	600g	650g	800g	550g	600g	700g	

STANDARD DELIVERY

Main unit	1 pc
Cable with lens	1 pc
32G SD card	1 pc
AC/DC adapter	1 pc
Video output cable	1 pc
USB cable	1 pc

OPTIONAL ACCESSORY

13.3" high-definition display (with stand and HDMI cable)	ISV-MS-DS
---	-----------

connect to 13.3" high-definition display (with stand and HDMI cable) (optional)



360° SWIVEL VIDEOSCOPIES

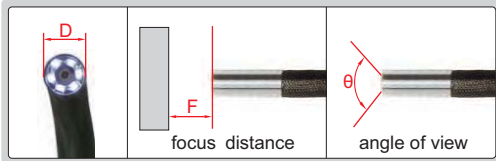
TUNGSTEN WIRE WEAVED CABLE
BREAK AND WEAR RESISTANCE

IP64
WATERPROOF

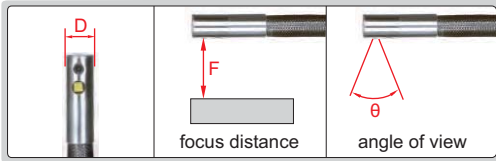
rapid change of lens cable



front view



side view



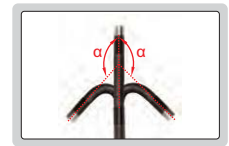
ISV-2000DS



bend in any direction



360° swivel in clockwise and counter-clockwise



bending range of lens

SPECIFICATION

Code	ISV-2002DS	ISV-2000DS	ISV-2001DS	ISV-3002DS	ISV-3000DS	ISV-3001DS	ISV-4000DS	
Lens	direction	front view					side view	
	diameter (D)	6.5mm			4mm		6.5mm	
	focus distance (F)	15mm~∞			8~80mm		5~25mm	
	bending range (α)	±160°	±160°	±120°	±120°	±120°	±120°	±160°
	angle of view (θ)	90°			80°		>90°	
	illumination	6 pcs LED			6 pcs LED		1 pc LED	
	pixel	0.44M			0.4M		0.3M	
	resolution	800×480					640×480	
	dust/waterproof	IP64						
	bend control	manual joystick						
Cable	length	1m	1.5m	3m	1m	1.5m	3m	1.5m
	type	tungsten wire weaved cable						
Main unit	function	take picture, take video						
	file format	picture: JPG, video: AVI						
	image process	brightness, image quality zoom (1X, 2X, 3X)						
	memory	8G SD card						
	output	TV, USB						
power supply	rechargeable battery (for 4 hours working) AC/DC adapter (for continuous working)							
Weight	600g	650g	800g	550g	600g	700g	650g	

STANDARD DELIEVERY

Main unit	1 pc
Cable with lens	1 pc
8G SD card	1 pc
AC/DC adapter	1 pc
Video output cable	1 pc
USB cable	1 pc

ATTENTION: RESISTANCE TO ACID AND ALKALI LIQUID (CONSULT IS NEEDED)

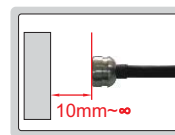
PIPE VIDEOSCOPE CODE ISV-VP280

IP68
WATERPROOF

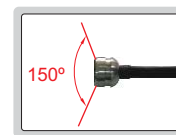


SPECIFICATION

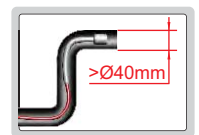
Lens	diameter	28mm
	dust/waterproof	IP68
	pixel	0.3M
	resolution	640×480
	frame	30fps
Cable	length	30m
	dust/waterproof	IP68
	type	semi-rigid
Main unit	function	take picture and video
	file format	picture: JPG, video: ASF
	image process	mirror, rotate, zoom (1.5X, 2X)
	memory	4G SD card
	output	TV, USB
	power supply	4×AA batteries
Weight		5kg



focus distance



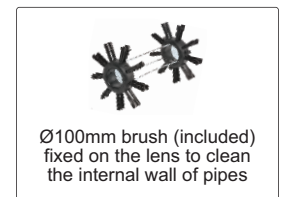
angle of view



can turn at least two times in the pipe (>Ø40mm)



Ø50mm centering ring (optional) fixed on the lens to center lens in the pipe



Ø100mm brush (included) fixed on the lens to clean the internal wall of pipes

STANDARD DELIVERY

Main unit	1 pc
Cable with lens	1 pc
Stand	1 pc
Indicator of cable working length	1 pc
4G SD card	1 pc
Ø100mm brush	1 pc
AA battery	4 pcs
AAA battery	2 pcs
Video output cable	1 pc
USB cable	1 pc

OPTIONAL ACCESSORY

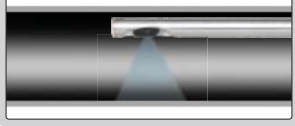
Ø50mm centering ring	ISV-VP280-R50
Ø150mm brush	ISV-VP280-B150

SIDE VIEW VIDEOSCOPE (RIGID) CODE ISV-RV



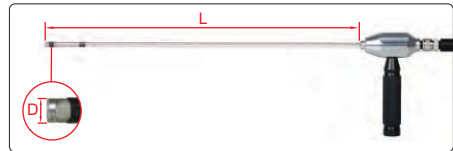
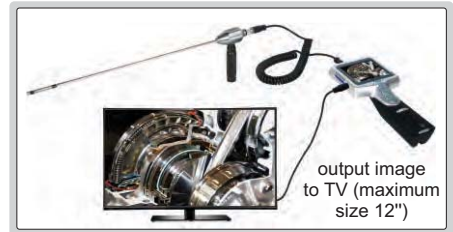
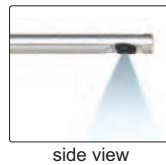
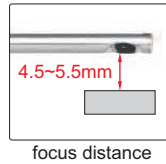
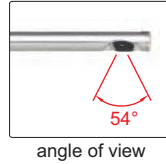
IP57
WATERPROOF

to observe internal wall of holes
(minimum diameter \varnothing 10mm)



SPECIFICATION

Diameter (D)	5.5mm
Length (L)	350mm
Dust/waterproof probe	IP57
Pixel	0.3M
Resolution	640x480
Frame rate	30fps
Function	take picture, take video
File format	picture: JPG, video: AVI
Memory	2G SD card
Output	TV, USB
Power supply	rechargeable battery (for 3 hours working)
Weight	570g



STANDARD DELIVERY

Main unit	1 pc
2G SD card	1 pc
AC/DC adapter	1 pc
Video output cable	1 pc
USB cable	1 pc

VIDEOSCOPE CODE ISV-E10



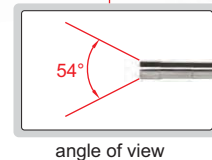
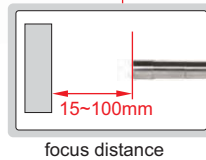
**ATTENTION: THE CABLE CAN BE BENT
BUT CAN'T BE SET AT A FIXED SHAPE**

**OPTIONAL CABLE
LENGTH 3M, 5M AND 10M**

IP65
WATERPROOF

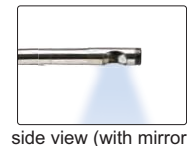
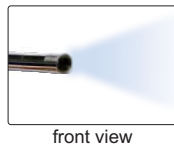
SPECIFICATION

Lens	diameter	5.5mm
	pixel	0.3M
	resolution	640x480
	frame rate	30fps
Cable	length	1m
	type	steel wire weaved cable
Main unit	function	take picture, take video
	file format	picture: JPG, video: AVI
	image process	brightness, contrast, color saturation
	memory	2G SD card
	output	TV, USB
power supply	rechargeable battery (for 3 hours working)	
Weight	450g	



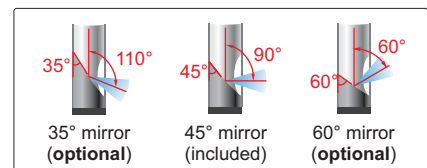
STANDARD DELIVERY

Main unit	1 pc
Cable with lens	1 pc
2G SD card	1 pc
45° mirror	1 pc
AC/DC adapter	1 pc
Video output cable	1 pc
USB cable	1 pc
Lens cleaning kit	1 pc



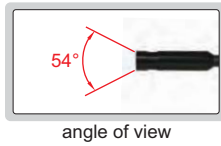
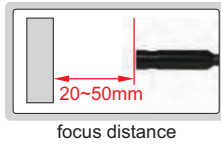
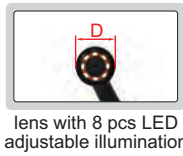
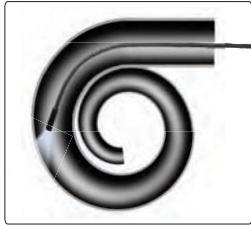
OPTIONAL ACCESSORY

35° mirror	ISV-E55-M35
60° mirror	ISV-E55-M60



IP57
WATERPROOF

the cable has high illumination and can be set at any shape. it is suitable to observe large internal space like turbocharger.



memory cable length: 1m



VIDEOSCOPE CODE ISV-E20

SPECIFICATION

Lens	diameter (D)	12mm
	pixel	0.4M
	resolution	720×682
	frame rate	30fps
Cable	length	1m
	type	memory (can be set at any shape)
Main unit	function	take picture, take video
	file format	picture: JPG, video: AVI
	image process	brightness, contrast, color saturation
	memory	2G SD card
	output	TV, USB
Weight	power supply	rechargeable battery (for 3 hours working)
		600g

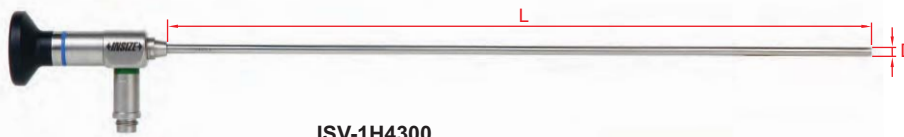


STANDARD DELIVERY

Main unit	1 pc
Cable with lens	1 pc
2G SD card	1 pc
AC/DC adapter	1 pc
Video output cable	1 pc
USB cable	1 pc
Lens cleaning kit	1 pc

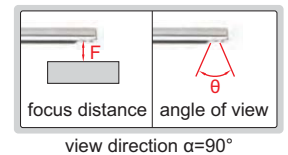
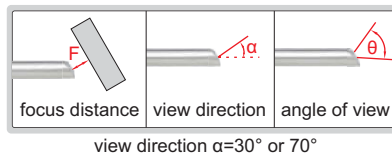
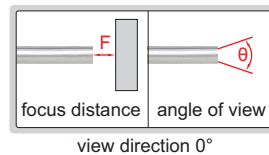
OPTIONAL ACCESSORY

45° mirror	ISV-E20-MIRROR
Hook	ISV-E20-HOOK
Magnet pick up	ISV-E20-MAGNET



ISV-1H4300

- Focus distance: 2mm, depth of view: 5~100mm
- Dust/waterproof level: IP67
- Can be used in liquid with temperature -10°C~85°C



SPECIFICATION

Code	Length (L)	View direction (α)	Diameter (D)	Angle of view (θ)
ISV-1H4170	174mm	0°	4mm	≥60°
ISV-1H4173	174mm	30°		
ISV-1H4177	174mm	70°		
ISV-1H4179	166mm	90°		
ISV-1H4300	302mm	0°		
ISV-1H4303	302mm	30°		
ISV-1H4307	302mm	70°		
ISV-1H4309	297mm	90°		

Code	Length (L)	View direction (α)	Diameter (D)	Angle of view (θ)
ISV-1H6200	209mm	0°	6mm	≥70°
ISV-1H6203	209mm	30°		
ISV-1H6207	209mm	70°		
ISV-1H6209	166mm	90°		
ISV-1H6320	328mm	0°		
ISV-1H6323	328mm	30°		
ISV-1H6327	328mm	70°		
ISV-1H6329	330mm	90°		

OPTIONAL ACCESSORY

LED light handle	ISV-1HLED
Adjustable LED light source	ISV-1LED1
Camera and display	ISV-2CAM



RIGID BORESCOPIES

IP67
WATERPROOF

LED LIGHT HANDLE CODE ISV-1HLED

- For rigid borescopes



battery (included)



charger (included)



SPECIFICATION

Power	3W
Battery	3.7V rechargeable battery (for 2 hours working)
Dimension	120×27×27mm
Weight	300g

STANDARD DELIVERY

Main unit	1 pc
Battery	1 pc
Charger	1 pc

ADJUSTABLE LED LIGHT SOURCE CODE ISV-1LED1

- For rigid borescopes
- High LED illumination and brightness is adjustable
- For long time work with low noise



SPECIFICATION

Color temperature	5600K
Cooling	fan cooling
Power	AC110~220V, 50/60Hz
Dimension	400×300×112mm
Weight	7kg

STANDARD DELIVERY

Main unit	1 pc
1.8m optical fiber cable	1 pc

CAMERA (WITH DISPLAY) CODE ISV-2CAM



- For rigid borescopes
- 1080P high-definition image
- Auto-focus camera
- Take pictures and videos, saved to USB flash disk
- Automatic white balance and exposure
- Brightness, contrast ratio, gain are adjustable

SPECIFICATION

Sensor	1/2.8" CMOS
Pixel	2M
Resolution	1920×1080
Frame rate	60fps
Output	HDMI
Power supply	power adapter
Dimension (L×W×H)	350×100×430mm
Weight	2kg



STANDARD DELIVERY

Camera	1 pc
Connector	1 pc
13.3" LCD (with stand)	1 pc
16G USB flash disk	1 pc
Mouse	1 pc
HDMI cable	1 pc
Power adapter	2 pcs



16G USB flash disk (included)



DATA OUTPUT

CAN BE CONTROLLED BY COMPUTER



ROUGHNESS TESTER CODE ISR-C002

- 21 roughness parameters
- Display roughness value, profile and curve
- Memory of maximum 100 results
- Automatic power off



printer (optional)



data transmission cable (optional)



software CD (included)



software (included)

control the roughness tester by computer, display roughness value, profile and curve

adjustable stand (included)



probe cover (included)



screen display

measurement result

Rmr analysis

roughness profile

To be continued

Continued from previous page

Unit: mm

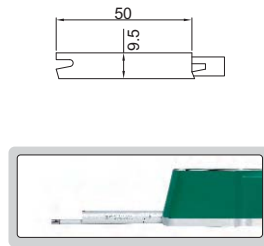
light duty test stand (optional)



heavy duty test stand (optional)



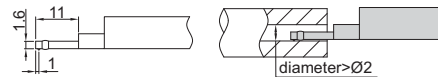
extension rod (optional),
code ISR-C002-ER



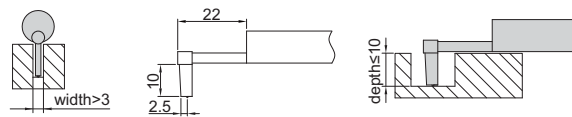
transverse rod (optional),
code ISR-C002-TR



small hole probe (optional),
code ISR-C002-SBP



deep groove probe (optional),
code ISR-C002-DGP



SPECIFICATION

Parameters		Ra, Rz, Rq, Rv, Rp, RS, R3z, R3y, Rt, Rz (JIS), Rk, Rku, Rsm, Rpc, Rpk, Rvk, Rsk, Mr1, Mr2, Ry (JIS), Rmax
Range		160µm
Accuracy		±10%
Resolution (Ra)		0.001µm
Probe	type	inductive
	stylus radius/angle	5µm/90°
	stylus material	diamond
Measuring force		4mN
Measuring unit		µm/µin
Cut off		0.25/0.8/2.5mm
Number of cut-off		1 to 5
Traverse speed		0.5mm/s, 1mm/s
Memory		100 measurement results
Output		USB
Power		built-in rechargeable battery
Dimension (L×W×H)		141×55×40mm
Weight		400g

STANDARD DELIVERY

Main unit	1 pc
Standard probe	1 pc
Calibration block and support	1 pc of each
Adjustable stand	1 pc
Probe cover	1 pc
Software	1 pc
AC/DC adapter	1 pc

OPTIONAL ACCESSORY

Extension rod	ISR-C002-ER
Transverse rod	ISR-C002-TR
Deep groove probe	ISR-C002-DGP
Small hole probe	ISR-C002-SBP
Light duty test stand	ISR-C002-STAND1
Heavy duty test stand	ISR-C002-STAND
Printer	ISR-C002-PRINTER
Data transmission cable	ISR-C002-SPC



BLUETOOTH

TOUCH SCREEN

CAN BE OPERATED BY COMPUTERS OR MOBILE PHONES

ROUGHNESS TESTER (SEPARABLE TYPE) CODE ISR-C300

DATA OUTPUT

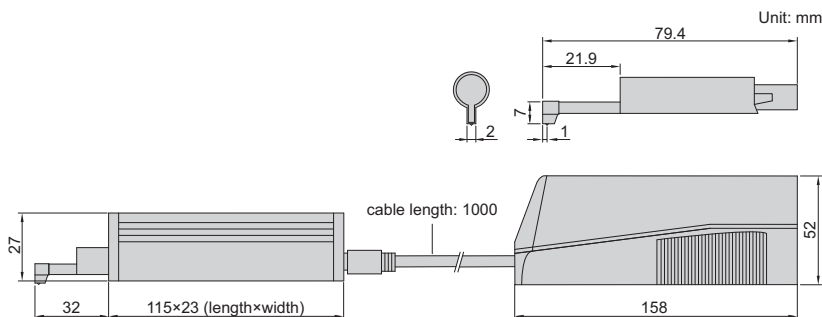


- Roughness tester can be operated by mobile phones (only Android system) or computers
- Data can be sent to Excel by connecting with computers via bluetooth or USB cable
- Support bluetooth printer
- 22 roughness parameters
- Meet ISO, DIN, ANSI, JIS standards
- Display roughness values, profile and curve
- Memory of maximum 100 data and waveform
- Built-in lithium battery, working time more than 50 hours
- Touch screen
- Automatic power off



software CD (included)

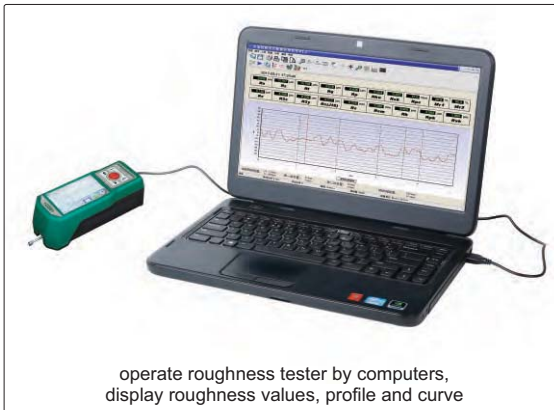
probe and main unit can be combined together



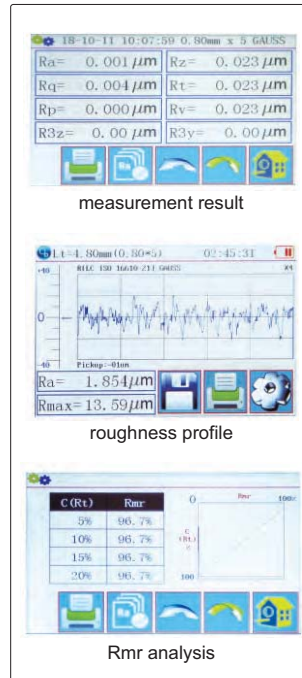
connect to mobile phones via bluetooth (only Android system)



connect to computers via USB cable (software is included)



roughness tester screen display



data can be sent to Excel by connecting to computer via bluetooth or USB cable

bluetooth receiver (optional)



adjustable stand (included)

height is adjustable (40mm)



To be continued

Continued from previous page

bluetooth printer (optional)



magnetic stand adapter (included)



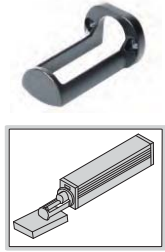
height gage adapter (optional)



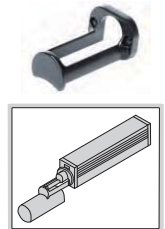
NOTE: Please check whether the adapter can fit your height gages. When using **INSIZE** height gages, please use the dial test indicator holder of height gages

probe support (optional)

support for flat surface



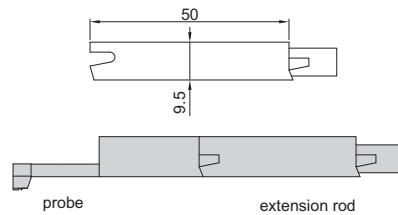
support for cylindrical surface



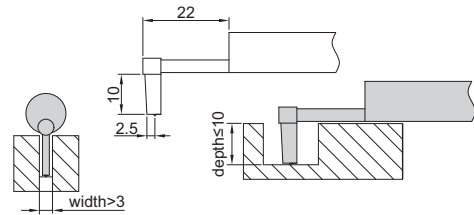
optional probes

Unit: mm

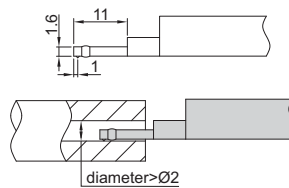
extension rod (optional), code **ISR-C002-ER**



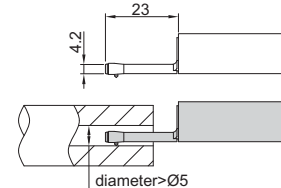
deep groove probe (optional), code **ISR-C002-DGP**



tiny hole probe (optional), code **ISR-C002-SBP**



small hole probe (optional), code **ISR-C002-PROBE**



SPECIFICATION

Parameters		Ra, Rz, Rq, Rv, Rp, Rs, R3z, R3y, Rt, Rc, Rz (JIS), Rk, Rku, Rsm, Rpc, Rpk, Rvk, Rsk, Mr1, Mr2, Ry, Rmax
Range	X axis	17.5mm
	Z axis	320µm (-160µm~160µm)
Accuracy		±10%
Resolution (Ra)		0.001µm
Probe	type	inductive
	stylus radius/angle	5µm/90°
	stylus material	diamond
Measuring force		4mN
Measuring unit		µm/µin
Cut off		0.25/0.8/2.5mm
Number of cut-offs		1~5
Traverse speed		0.135mm/s, 0.5mm/s, 1mm/s
Memory		100 measurement results
Output		USB and bluetooth
Power		built-in rechargeable battery
Dimension (L×W×H)		158×64×52mm
Weight		400g

STANDARD DELIVERY

Main unit	1 pc
Standard probe	1 pc
Calibration block and support	1 pc of each
Connecting cable (long and short)	1 pc of each
Magnetic stand adapter	1 pc
Adjustable stand	1 pc
Touch pen	1 pc
Software and USB cable	1 pc
AC/DC adapter	1 pc

OPTIONAL ACCESSORY

Extension rod	ISR-C002-ER
Small hole probe	ISR-C002-PROBE
Tiny hole probe	ISR-C002-SBP
Deep groove probe	ISR-C002-DGP
Bluetooth printer	ISR-C002-PRINTER
Height gage adapter	ISR-C300-LB1
Bluetooth receiver	ISR-C300-RECEIVER
Support for flat surface	ISR-C300-COVER1
Support for cylindrical surface	ISR-C300-COVER2

ROUGHNESS TESTER CODE ISR-C003

fixture for small shafts
(optional)



calibration block (included)

- Unit: μm , μin
- Automatic power off

STANDARD DELIVERY

Main unit	1 pc
Calibration block	1 pc
AC/DC adapter	1 pc

SPECIFICATION

Parameters	Ra, Rz, Rq, Rt	
Range	Ra, Rq: 0.05~15 μm Rz, Rt: 0.1~50 μm	
Accuracy	$\pm 10\%$	
Resolution (Ra)	0.01 μm	
Probe	type	piezoelectric
	stylus radius/angle	10 $\mu\text{m}/90^\circ$
	stylus material	diamond
Measuring force	5mN	
Measuring unit	$\mu\text{m}/\mu\text{in}$	
Cut off	0.25/0.8/2.5mm	
Evaluation length	1.25mm for cut off 0.25mm 4mm for cut off 0.8mm 5mm for cut off 2.5mm	
Traverse speed	0.75mm/s	
Power	built-in rechargeable battery	
Dimension (L×W×H)	106×70×24mm	
Weight	200g	

OPTIONAL ACCESSORY

Fixture for small shafts	ISR-C003-FIXTURE
--------------------------	------------------

SURFACE ROUGHNESS SPECIMENS

INSIZE PLUS
MADE IN EUROPE

- For checking, identifying and specifying the roughness by symbol
- Rust-proof, made of pure Nickel



ISR-CS315

Code	Machining method	Roughness (Ra)	Roughness (Rz)	Quantity
ISR-CS315	Surface grinding	0.025, 0.05, 0.1, 0.2, 0.4, 0.8, 1.6, 3.2 μm	0.29, 0.55, 0.91, 1.74, 2.6, 4.65, 7.87, 15.6 μm	8 pcs
ISR-CS316	Cylindrical grinding	0.025, 0.05, 0.1, 0.2, 0.4, 0.8, 1.6, 3.2 μm	0.3, 0.53, 0.88, 1.56, 2.64, 4.4, 7.71, 15.3 μm	8 pcs
ISR-CS317	Flat lapping	Criss-cross	0.025, 0.05, 0.1, 0.2 μm	0.4, 0.6, 0.74, 1.26 μm
		Parallel	0.025, 0.05, 0.1, 0.2 μm	0.34, 0.56, 1.12, 1.5 μm
ISR-CS318	Cylindrical lapping	0.025, 0.05, 0.1, 0.2 μm	0.46, 0.54, 0.63, 1.23 μm	4 pcs
	Superfinishing	0.025, 0.05, 0.1, 0.2 μm	0.36, 0.7, 1, 1.4 μm	4 pcs
ISR-CS319	Face turning	0.4, 0.8, 1.6, 3.2, 6.3, 12.5, 25, 50 μm	1.92, 3.2, 6.15, 12.5, 23.7, 48.7, 102, 185 μm	8 pcs
ISR-CS320	Cylindrical turning	0.4, 0.8, 1.6, 3.2, 6.3, 12.5, 25, 50 μm	1.7, 3.2, 6.1, 12.2, 23.7, 47.5, 95, 190 μm	8 pcs
ISR-CS321	End milling	0.4, 0.8, 1.6, 3.2, 6.3, 12.5, 25, 50 μm	1.92, 3.82, 6.45, 12.2, 25.2, 49.8, 92.6, 191 μm	8 pcs
ISR-CS322	Reaming	0.4, 0.8, 1.6, 3.2 μm	1.7, 3.2, 6.4, 12.8 μm	4 pcs
	Drilling	1.6, 3.2, 6.3, 12.5 μm	7.5, 15.5, 31, 60 μm	4 pcs
ISR-CS323	Horizontal milling	0.4, 0.8, 1.6, 3.2, 6.3, 12.5, 25, 50 μm	1.8, 3.68, 6.63, 12.8, 25.6, 53, 97.5, 197 μm	8 pcs
ISR-CS325	Shaping (planing)	0.8, 1.6, 3.2, 6.3, 12.5, 25, 50, 100 μm	3.84, 6.7, 12.2, 25.2, 48.7, 99.9, 190, 361 μm	8 pcs
ISR-CS326	Linishing (belt sanding)	0.1, 0.2, 0.4, 0.8, 1.6, 3.2 μm	0.9, 1.55, 3.37, 7.42, 18.5, 31 μm	6 pcs
ISR-CS328	Vertical grinding	0.2, 0.4, 0.8, 1.6, 3.2, 6.3 μm	1.1, 3.5, 6.15, 8.78, 22.19, 40.8 μm	6 pcs
ISR-CS329	Grit blasting	3.2, 10.5, 18, 25 μm	19.2, 63, 108, 150 μm	4 pcs
	Shot blasting	3.2, 8, 13, 18 μm	19.2, 48, 78, 108 μm	4 pcs
ISR-CS331	Spark erosion (EDM)	0.4, 0.8, 1.6, 3.2, 6.3, 12.5, 25, 50 μm	2.5, 4.5, 7.2, 14.2, 24.7, 51.2, 105, 196 μm	8 pcs
ISR-CS333	Hand filing	0.4, 0.8, 1.6, 3.2, 6.3 μm	3, 5.6, 12.4, 22.5, 61 μm	5 pcs
ISR-CS334	Castings	0.8, 1.6, 3.2, 6.3, 12.5, 25, 50 μm	3.2, 8, 16, 32, 56, 112, 225 μm	7 pcs
ISR-CS335	Honing	0.05, 0.1, 0.2, 0.4, 0.8, 1.6 μm	0.31, 0.56, 1, 2, 4.2, 9 μm	6 pcs
ISR-CS336	Polishing	0.0125, 0.025, 0.05, 0.1, 0.2 μm	0.29, 0.35, 0.67, 0.72, 1.52 μm	5 pcs

SURFACE ROUGHNESS SPECIMEN SET CODE ISR-CS130-W

INSIZE PLUS
MADE IN EUROPE

- For checking, identifying and specifying the roughness by symbol
- Rust-proof, made of pure Nickel



Machining method	Roughness (Ra)	Roughness (Rz)	Quantity
Flat lapping	0.05, 0.1, 0.2µm	0.55, 1, 1.6µm	3 pcs
	2, 4, 8µin		
Reaming	0.4, 0.8, 1.6µm	3, 6, 10µm	3 pcs
	16, 32, 63µin		
Plain grinding	0.05, 0.1, 0.2, 0.4, 0.8, 1.6µm	0.55, 1, 1.6, 3, 6, 10µm	6 pcs
	2, 4, 8, 16, 32, 63µin		
Horizontal milling	0.4, 0.8, 1.6, 3.2, 6.3, 12.5µm	2.5, 4, 8, 16, 32, 50µm	6 pcs
	16, 32, 63, 125, 250, 500µin		
Vertical milling	0.4, 0.8, 1.6, 3.2, 6.3, 12.5µm	2.5, 4, 8, 16, 32, 50µm	6 pcs
	16, 32, 63, 125, 250, 500µin		
Turning	0.4, 0.8, 1.6, 3.2, 6.3, 12.5µm	2.5, 4, 8, 16, 32, 50µm	6 pcs
	16, 32, 63, 125, 250, 500µin		

SHOT AND GRIT BLASTING SURFACE ROUGHNESS SPECIMENS

INSIZE PLUS
MADE IN EUROPE

- To check the roughness of steel surfaces which have been blast cleaned before painting
- Meets ISO 8503/1
- Rust-proof, made of pure Nickel
- Each piece contains 4 parts



ISR-CS017

Code	Machining method	Roughness (Ra)	Roughness (Rz)
ISR-CS017	Shot blasting	3.2, 8, 13, 18µm	19.2, 48, 78, 108µm
ISR-CS018	Grit blasting	3.2, 10.5, 18, 25µm	19.2, 63, 108, 150µm

SURFACE ROUGHNESS REFERENCE SPECIMENS

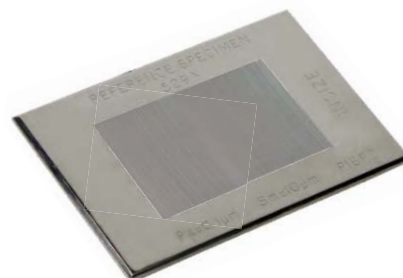
INSIZE PLUS
MADE IN EUROPE

MEASURING ACCURACY OF ROUGHNESS TESTERS CAN BE IMPROVED, IF THE CALIBRATION IS MADE ON A REFERENCE SPECIMEN WITH THE ROUGHNESS VALUE CLOSE TO THE WORKPIECE TO BE MEASURED

- To calibrate roughness testers
- Meets ISO 5436-1: 2000
- Rust proof, made of pure Nickel

Code	Roughness (Ra)
ISR-RS525X	6.25µm *
ISR-RS526X	3.15µm *
ISR-RS527X	3.0µm *
ISR-RS528X	0.5µm *
ISR-RS529X	0.1µm * (not suitable for ISR-S400)
ISR-RS530X	1.0µm *
ISR-RS531X	0.3µm * (not suitable for ISR-S400)

*The actual value may be slightly different



ISR-RS529X

SUITABLE FOR SMALL SURFACES,
CONCAVE OR CONVEX SURFACES

FOR MAGNETIC AND
NON-MAGNETIC SUBSTRATES

COATING THICKNESS GAGE

INSIZE PLUS
MADE IN EUROPE



magnetic induction probe Fe (optional)
ISO-2000FN-FE



eddy current probe NFe (optional)
ISO-2000FN-NFE

- Suitable for small surfaces, concave or convex surfaces
- Magnetic induction probe (Fe) measures the thickness of non-magnetic coating on magnetic substrate.
Substrate: iron, steel, magnetic stainless steel (not for non-magnetic stainless steel)
Coating: zinc, copper, chrome-tin, plastic powder, paint (not for nickel)
- Eddy current probe (NFe) measures the thickness of non-conductive coating on non-magnetic metal substrate.
Substrate: copper, aluminum, zinc, non-magnetic stainless steel
Coating: plastic powder, paint, anodizing



standard foils (included)

MAIN UNIT

Code	ISO-2000FN (without probes)	
Measuring range	magnetic induction probe (Fe)	0~2000µm
	eddy current probe (NFe)	0~800µm
Accuracy	±(1.5+2%L)µm L is measuring thickness in µm	
Resolution	0.1µm (range<100µm)	
	1µm (range 100~1000µm)	
	10µm (range≥1000µm)	
Repeatability	1µm (range 0~1000µm)	
	10µm (range≥1000µm)	
Measuring mode	continuous or single	
Calibration mode	four points calibration	
Minimum substrate thickness	magnetic induction probe (Fe): 0.2mm, eddy current probe (NFe): 0.05mm	
Minimum measuring area	5x5mm, calibration should be made on workpieces without coating	
Power supply	2×1.5V AA batteries	
Dimension of main unit	122×65×22mm	
Weight of main unit	150g	

STANDARD DELIVERY

Main unit	1 pc
Zero calibration block for Fe probe	1 pc
Zero calibration block for NFe probe	1 pc
Standard foil	7 pcs
Battery (AA)	2 pcs

PROBE (OPTIONAL)

Magnetic induction probe (Fe)	ISO-2000FN-FE
Eddy current probe (NFe)	ISO-2000FN-NFE

COATING THICKNESS GAGE CODE 9501-1200

FOR MAGNETIC AND
NON-MAGNETIC SUBSTRATES

DATA
OUTPUT



eddy current probe
NFE (optional) with
zero calibration block



magnetic induction
probe FE90 for bores
and grooves (optional)



magnetic induction
probe FE10 for large
range (optional)



zero calibration block
for FE (included)



calibration foils
(included)



data transmission
cable (optional)



magnetic induction
probe FE (included)



software CD
(included)

- Magnetic induction probe (FE) measures the thickness of non-magnetic coating on magnetic substrate.
Substrate: iron, steel, magnetic stainless steel (not for non-magnetic stainless steel)
Coating: zinc, copper, chrome, tin, plastic, powder, paint (not for nickel)
- Eddy current probe (NFE) measures the thickness of non-conductive coating on non-magnetic substrate.
Substrate: copper, aluminum, zinc, non-magnetic stainless steel
Coating: plastic, powder, paint, anodizing
- Tolerance measurement
- Automatic power off

SPECIFICATION

Probe type	FE (included) magnetic induction probe	NFE (optional) eddy current probe	FE90 (optional) magnetic induction probe for bores and grooves	Fe10 (optional) magnetic induction probe for large range
Measuring range	0~1250µm	0~1250µm	0~1250µm	500~10000µm
Accuracy	$\pm(3\%L+1)\mu\text{m}$ (range $\leq 1250\mu\text{m}$) $\pm(3\%L+10)\mu\text{m}$ (range $> 1250\mu\text{m}$) L is measuring thickness in µm			
Resolution	0.1µm (range $< 100\mu\text{m}$) 1µm (range $\geq 100\mu\text{m}$)			
Measuring mode	continuous and single			
Minimum substrate thickness	0.5mm	0.3mm	0.5mm	2mm
Minimum measuring area	Ø7mm	Ø5mm	Ø7mm	Ø40mm
Minimum curvature radius of convex workpiece	1.5mm	3mm	—	10mm
Memory	500			
Output	USB			
Power supply	2×1.5V AA batteries			
Dimension	128×68×32mm			
Weight	340g			

STANDARD DELIVERY

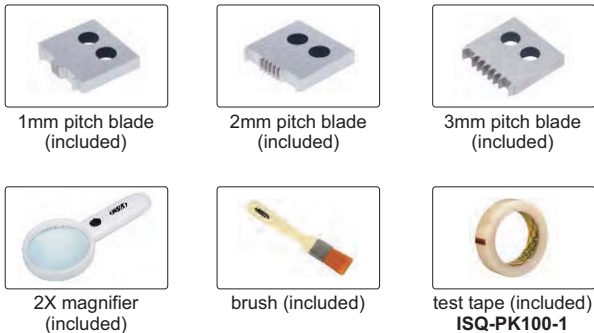
Main unit	1 pc
Magnetic induction probe (FE)	1 pc
Zero calibration block for FE probe	1 pc
Calibration foils (50µm, 100µm, 250µm, 500µm, 1000µm)	1 set
1.5V AA battery	2 pcs
Software and USB cable	1 pc

OPTIONAL ACCESSORY

Data transmission cable	9501-1200-SPC
Eddy current probe (NFE) with zero calibration block	9501-1200-NFE
Magnetic induction probe (FE90) for bores and grooves	9501-1200-FE90
Magnetic induction probe (FE10) for large range	9501-1200-FE10

CROSS CUT ADHESION TESTER CODE ISQ-PK100

- To test the adhesion of paint coating on metal, wood, plastic, etc.
- According to ISO 2409, ASTM D3359, DIN53151



SPECIFICATION

Blade		1mm pitch	2mm pitch	3mm pitch
Applied paint thickness	on hard substrate (like metal)	0~60µm	61~120µm	121~250µm
	on soft substrate (like wood, plaster)	—	0~120µm	121~250µm
Minimum substrate thickness	hard substrate (like metal)	0.25mm	0.25mm	0.25mm
	soft substrate (like wood, plaster)	—	10mm	10mm
Minimum size of test sample		150×100mm	150×100mm	150×100mm
Dimension		170×28×40mm		
Weight		430g		

STANDARD DELIVERY

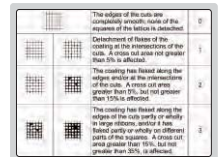
Handle	1 pc
1mm pitch blade	1 pc
2mm pitch blade	1 pc
3mm pitch blade	1 pc
Test tape (ISQ-PK100-1)	1 pc
2X magnifier	1 pc
Brush	1 pc



step 1: make grid cutting on surface



step 2: paste and remove the tape



step 3: according to the shedding status, judge the adhesion grade

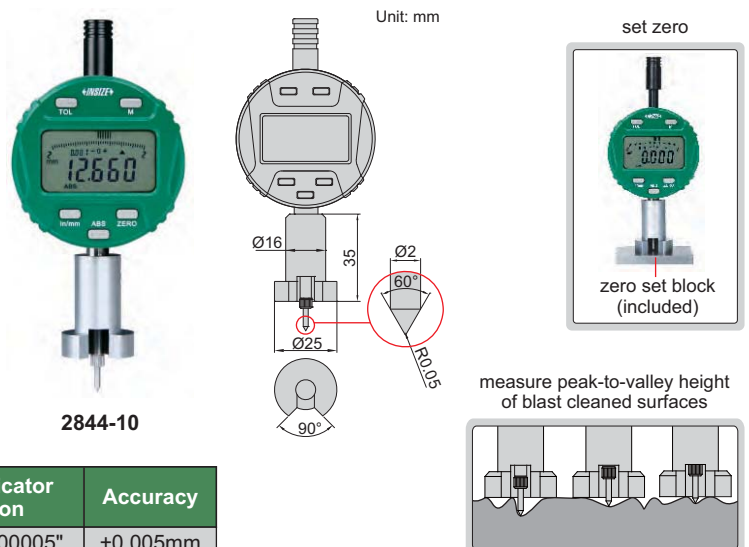
DATA OUTPUT

DISPLAY MAXIMUM, MINIMUM, DIFFERENCE VALUE BETWEEN MAXIMUM AND MINIMUM



- Measure peak-to-valley height of blast cleaned surface. If the profile is too low, the adhesion of the coating to the surface will be reduced. If the profile is too high, there is the danger that the profile peaks will remain uncoated, allowing rust spots to occur.
- Meet ASTM D 4417-B
- Zero set block is included, set zero before measurement
- Button function: tolerance Go and No-Go display, data preset, measuring direction change, max./min./TIR measurement, inch/metric conversion, absolute/incremental measurement
- CR2032 battery, automatic power off
- Data output
- Stainless steel base
- Optional accessory: data output cable (code 7315-50M, 7302-40M, 7305-40M)

DIGITAL SURFACE PROFILE GAGE



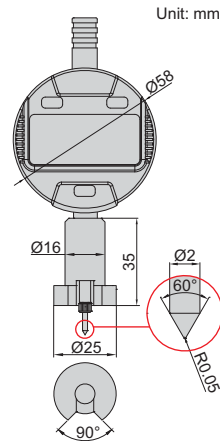
Code	Range	Digital indicator stroke	Digital indicator resolution	Accuracy
2844-10	0-12.7mm/0-0.5"	12.7mm/0.5"	0.001mm/0.00005"	±0.005mm

DIGITAL SURFACE PROFILE GAGE

- Measure peak-to-valley height of blast cleaned surface. If the profile is too low, the adhesion of the coating to the surface will be reduced. If the profile is too high, there is the danger that the profile peaks will remain uncoated, allowing rust spots to occur.
- Meet ASTM D 4417-B
- Zero set block is included, set zero before measurement
- Button function: on/off, zero, mm/inch, absolute/incremental measurement
- CR2032 battery, automatic power off
- Data output
- Stainless steel base
- Optional accessory: data output cable (code 7315-50M, 7302-40M, 7305-40M)



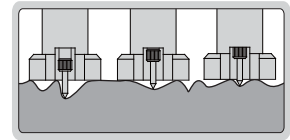
2843-10



DATA OUTPUT



measure peak-to-valley height of blast cleaned surfaces



Code	Range	Digital indicator stroke	Digital indicator resolution	Accuracy
2843-10	0-12.7mm/0-0.5"	12.7mm/0.5"	0.001mm/0.00005"	±0.005mm

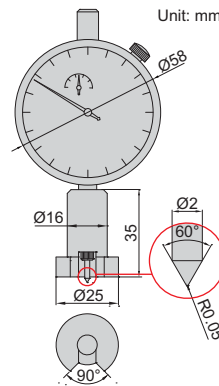


SURFACE PROFILE GAGE

- Measure peak-to-valley height of blast cleaned surface. If the profile is too low, the adhesion of the coating to the surface will be reduced. If the profile is too high, there is the danger that the profile peaks will remain uncoated, allowing rust spots to occur.
- Meet ASTM D 4417-B
- Zero set block is included, set zero before measurement
- Stainless steel base



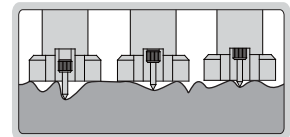
2344-1



set zero



measure peak-to-valley height of blast cleaned surfaces

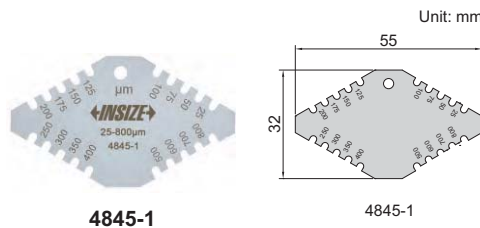


Code	Range	Dial indicator stroke	Dial indicator graduation	Accuracy
2344-1	0-1mm	1mm	0.001mm	±0.005mm



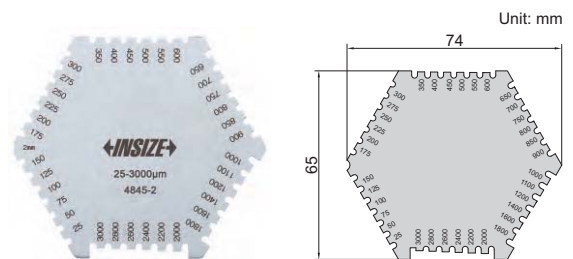
WET FILM GAGES

- Made of stainless steel



4845-1

4845-1



4845-2

4845-2

Code	Range	Accuracy	Thickness
4845-1	25-800µm	±5µm	1.8mm
4845-2	25-3000µm	25-100µm: ±5µm 100µm-3000µm: ±5%	1mm

DATA
OUTPUT

WITH A AND B SCAN

PENETRATE NON-METALLIC COATING AND
MEASURE THE THICKNESS OF METAL SUBSTRATES

ULTRASONIC THICKNESS GAGE CODE ISU-720D

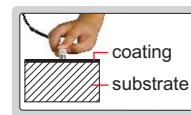


- Two measuring modes, Echo-Echo (E-E) and Transmit-Echo (T-E):
 - E-E is applicable for non-metallic coating (such as paint, plastic resin, etc.) on metal substrates, can penetrate coating and measure the thickness of substrates
 - T-E is to measure the thickness of material without coating, such as metal, plastic, glass, nylon, resin, ceramics, ice, etc.
- A scan, through the waveform, judges whether there are impurities, pores, cracks and so on inside, in order to avoid wrong measurement
- B scan, measures continuously, displays the thickness change on the screen
- Transducers can be automatically identified and zeroed
- Memory 10000 measurement values and transmitted through USB cable
- Automatic or manual measurement
- When transducers are removed from workpieces, the measurement data are held on screen for easy viewing
- Set upper and lower limits for alarm when out-of-tolerance
- Automatic power off

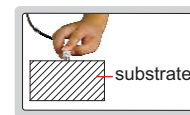


SPECIFICATION

Measuring range	T-E mode: substrate thickness 1.5~200mm
	E-E mode: substrate thickness 3~25mm
Measuring unit	mm/inch
Resolution	0.1/0.01mm
Accuracy	±0.04mm (H<9.9mm)
	±(0.04+0.1%H)mm (H: 10~99.9mm) ±(0.3%H)mm (H>100mm) H is the thickness to be measured in mm
Frequency	5.0MHZ
Display	320×240, color screen display
Velocity	1000~9999m/s
Measuring frequency	2 times/second and 10 times/second
Applicable temperature	-20~50°C
Output	USB
Power supply	2×1.5V AA batteries
Dimension	133×75×29mm
Weight	260g (including batteries)



Echo-Echo mode (E-E)



Transmit-Echo mode (T-E)



couplant (included)

transducer ISU-T04 (optional)



transducer ISU-T06 (optional)



transducer ISU-T08 (optional)



transducer ISU-T12 (optional)



transducer ISU-T13 (optional)



transducer ISU-T25 (optional)



STANDARD DELIVERY

Main unit	1 pc
Bicrystal transducer ISU-T07	1 pc
Battery (AA)	2 pcs
Couplant	1 bottle
USB cable	1 pc

OPTIONAL ACCESSORY

Transducer	ISU-T04, ISU-T06, ISU-T08, ISU-T12, ISU-T13, ISU-T25
Couplant (for ISU-T13)	ISU-HT5-COULPLANT

SPECIFICATION OF TRANSDUCERS

Code	Mode	Frequency	Diameter (Ød)	Measuring range	Minimum size of pipes for measurement (diameter × wall thickness)	Applicable temperature	Application
ISU-T07 (included)	T-E E-E	5.0MHz	13.2mm	T-E mode: 1.5~200mm E-E mode: 3~25mm	T-E mode: Ø25×3mm	<60°C	general use
ISU-T04 (optional)	T-E	10.0MHz	6mm	0.7~20mm	Ø15×1mm	<60°C	for small tubes
ISU-T06 (optional)	T-E	7.5MHz	9mm	0.7~50mm	Ø15×1.2mm	<60°C	for thin workpieces
ISU-T08 (optional)	T-E	5.0MHz	11mm	0.8~300mm	Ø25×1.2mm	<60°C	general use
ISU-T12 (optional)	T-E	2.0MHz	17mm	2~400mm	Ø40×3mm	<60°C	for casting iron
ISU-T13 (optional)	T-E	5.0MHz	15mm	2~200mm	Ø25×2mm	<350°C	for high temperature
ISU-T25 (optional)	T-E	1.0MHz	26mm	3~200mm	-	<60°C	for fiberglass and organic material

ULTRASONIC THICKNESS GAGE (FOR THICK WORKPIECES MADE OF ORGANIC MATERIALS) CODE ISU-710D

DATA
OUTPUT

WITH A AND B SCAN

SPECIFICATION

Measuring range	20~590mm	
Measuring unit	mm/inch	
Resolution	0.1/0.01mm	
Accuracy	$\pm(0.04+0.1\%H)$ mm (H: 10~99.9mm) $\pm(0.3\%H)$ mm (H>100mm) H is the thickness to be measured in mm	
Transducer	Type	Monocrystal probe
	Frequency	1.0MHz
	Diameter (Ød)	26mm
Display	320×240, color screen display	
Velocity	1000~9999m/s	
Measuring frequency	2 times/second and 10 times/second	
Applicable temperature	-20~50°C	
Output	USB	
Power supply	2×1.5V AA batteries	
Dimension	133×75×29mm	
Weight	260g (including batteries)	

STANDARD DELIVERY

Main unit	1 pc
Transducer	1 pc
Battery (AA)	2 pcs
Couplant	1 bottle
USB cable	1 pc



- For thick workpieces made of organic materials
- A scan, through the waveform, judges whether there are impurities, pores, cracks and so on inside, in order to avoid wrong measurement
- B scan, measures continuously, displays the thickness change on the screen
- Transducers can be automatically identified and zeroed
- Memory 10000 measurement values and transmitted through USB cable
- Automatic or manual measurement
- When transducers are removed from workpieces, the measurement data are held on screen for easy viewing
- Set upper and lower limits for alarm when out-of-tolerance
- Automatic power off

ULTRASONIC THICKNESS GAGE (FOR THIN WORKPIECES) CODE ISU-700D



DATA
OUTPUT

WITH A AND B SCAN

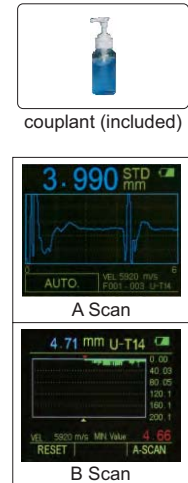
SPECIFICATION

Measuring range	Transmit-echo (T-E) mode: 1.5~20mm Echo-echo (E-E) mode: 0.2~10mm	
Measuring unit	mm/inch	
Resolution	0.1/0.01/0.001mm	
Accuracy	± 0.04 mm (H<9.99mm) $\pm(0.04+0.1\%H)$ mm (H≥10mm) H is the thickness to be measured in mm	
Transducer	Type	Monocrystal probe
	Frequency	15.0MHz
	Diameter (Ød)	7.5mm
Display	320×240, color screen display	
Velocity	1000~9999m/s	
Measuring frequency	2 times/second and 10 times/second	
Applicable temperature	-20~50°C	
Output	USB	
Power supply	2×1.5V AA batteries	
Dimension	133×75×29mm	
Weight	260g (including batteries)	

STANDARD DELIVERY

Main unit	1 pc
Transducer	1 pc
Transducer protective sleeve	1 pc
Battery (AA)	2 pcs
Couplant	1 bottle
USB cable	1 pc

transducer protection
sleeve (included)



- For thin workpieces
- A scan, through the waveform, judges whether there are impurities, pores, cracks and so on inside, in order to avoid wrong measurement
- B scan, measures continuously, displays the thickness change on the screen
- Transducers can be automatically identified and zeroed
- Memory 10000 measurement values and transmitted through USB cable
- Automatic or manual measurement
- When transducers are removed from workpieces, the measurement data are held on screen for easy viewing
- Set upper and lower limits for alarm when out-of-tolerance
- Automatic power off

PENETRATE NON-METALLIC COATING AND MEASURE THE THICKNESS OF METAL SUBSTRATE

DATA OUTPUT

INSPECTION CERTIFICATE

ULTRASONIC THICKNESS GAGE (THROUGH COATING) CODE ISU-300D

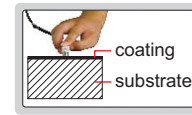


- Two measuring modes, Echo-Echo (E-E) and Transmit-Echo (T-E):
 - E-E is applicable for non-metallic coating (such as paint, plastic resin, etc.) on metal substrates, can penetrate coating and measure the thickness of substrates
 - T-E is to measure the thickness of material without coating, such as metal, plastic, glass, nylon, resin, ceramics, ice, etc.
- Tolerance measurement
- Average calculation of maximum 9 readings
- Data can be input to Excel and Word as keyboard signal

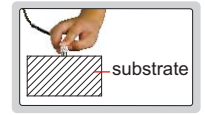


SPECIFICATION

Measuring range	E-E mode: coating thickness 0~1mm, substrate thickness 4~25mm
	T-E mode: substrate thickness 1.5~200mm
Resolution	0.01mm (range<100mm) 0.1mm (range≥100mm)
Repeatability	0.03mm (range<100mm) 0.1mm (range≥100mm)
Accuracy	±0.04mm (range<10mm) ±(0.04+H/1000)mm (range 10~100mm) ±H/333mm (range≥100mm) H is the thickness to be measured in mm
Velocity	1000~9999m/s
Power supply	2×1.5V AAA batteries
Dimension	116×64×27mm
Weight	220g



Echo-Echo mode (E-E)



Transmit-Echo mode (T-E)



couplant (included)



transducer ISU-T04 (optional)



transducer ISU-T06 (optional)



transducer ISU-T12 (optional)



transducer ISU-T13 (optional)

STANDARD DELIVERY

Main unit	1 pc
Transducer ISU-T07	1 pc
Battery (AAA)	2 pcs
Couplant (for ISU-T04, ISU-T06, ISU-T07, ISU-T12)	1 bottle
USB cable	1 pc

OPTIONAL ACCESSORY

Transducer	ISU-T04, ISU-T06, ISU-T12, ISU-T13
Couplant (for ISU-T13)	ISU-HT5-COULPLANT

SPECIFICATION OF TRANSDUCERS

Code	Mode	Frequency	Diameter (Ød)	Measuring range	Minimum size of pipes for measurement (diameter × wall thickness)	Applicable temperature	Application
ISU-T07 (included)	T-E E-E	5.0MHz	13.2mm	T-E mode: 1.5~200mm E-E mode: 3~25mm	T-E mode: 20×1.2mm E-E mode: 20×4mm	<60°C	general use
ISU-T04 (optional)	T-E	10.0MHz	6mm	0.7~20mm	10×1mm	<60°C	for small tubes
ISU-T06 (optional)	T-E	7.5MHz	8.5mm	0.7~50mm	15×1.2mm	<60°C	for thin workpieces
ISU-T12 (optional)	T-E	2.0MHz	16.3mm	2~400mm	30×4mm	<60°C	for casting iron
ISU-T13 (optional)	T-E	5.0MHz	13mm	2~200mm	25×3mm	<350°C	for high temperature

ULTRASONIC THICKNESS GAGE CODE ISU-250C



DATA
OUTPUT



- Measure the thickness from one side of objects, suitable for pipes, tanks, etc.
- Applicable material: metal, plastic, glass, nylon, resin, ceramic, ice
- Tolerance measurement
- Average calculation of 9 readings
- Data can be input to Excel and Word as keyboard signal

SPECIFICATION

Resolution	0.01mm (range<100mm)
	0.1mm (range≥100mm)
Repeatability	0.03mm (range<100mm)
	0.1mm (range≥100mm)
Accuracy	±0.04mm (range<10mm)
	±(0.04+H/1000)mm (range 10~100mm)
	±H/333mm (range≥100mm)
	H is the thickness to be measured in mm
Velocity	1000-9999m/s
Power supply	2×1.5V AAA batteries
Dimension	64×116×27mm
Weight	220g



couplant (included)



transducer ISU-T04 (optional)



transducer ISU-T06 (optional)



transducer ISU-T12 (optional)



transducer ISU-T13 (optional)

STANDARD DELIVERY

Main unit	1 pc
Transducer ISU-T08	1 pc
Battery (AAA)	2 pcs
Couplant (for ISU-T04, ISU-T06, ISU-T08, ISU-T12)	1 bottle
USB cable	1 pc

OPTIONAL ACCESSORY

Transducer	ISU-T04, ISU-T06, ISU-T12, ISU-T13
Couplant (for ISU-T13)	ISU-HT5-COUPPLANT

SPECIFICATION OF TRANSDUCERS

Code	Frequency	Diameter (Ød)	Measuring range	Minimum size of pipes for measurement (diameter × wall thickness)	Applicable temperature	Application
ISU-T08 (included)	5.0MHz	10.8mm	0.8~300mm	20×1.2mm	<60°C	general use
ISU-T04 (optional)	10.0MHz	6mm	0.7~20mm	10×1mm	<60°C	for small tubes
ISU-T06 (optional)	7.5MHz	8.5mm	0.7~50mm	15×1.2mm	<60°C	for thin workpieces
ISU-T12 (optional)	2.0MHz	16.3mm	2~400mm	30×4mm	<60°C	for casting iron
ISU-T13 (optional)	5.0MHz	13mm	2~200mm	25×3mm	<350°C	for high temperature

ULTRASONIC THICKNESS GAGE (BASIC TYPE) CODE ISU-100D

- Measure the thickness from one side of objects, suitable for pipes, tanks, etc.
- Applicable material: metal, plastic, glass, nylon, resin, ceramic, ice

SPECIFICATION

Measuring range	0.8~300mm
Resolution	0.01mm (range<100mm)
	0.1mm (range≥100mm)
Accuracy	±0.04mm (range<10mm)
	±(0.04+H/1000)mm (range 10~100mm)
	±H/333mm (range≥100mm)
	H is the thickness to be measured in mm
Transducer	frequency
	diameter (Ød)
Minimum size of pipes for measurement	20×1.2mm (diameter × wall thickness)
Applicable temperature	<60°C
Velocity	1000-9999m/s
Power supply	2×AAA batteries
Dimension	114×64×28mm
Weight	200g



ATTENTION: NOT SUITABLE FOR CASTING WORKPIECES



STANDARD DELIVERY

Main unit	1 pc
Transducer	1 pc
Couplant	1 bottle
Battery (AAA)	2 pcs



VIDEO

LASER DISTANCE METERS

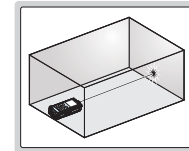


9561-80

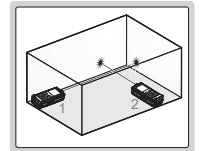
- Large display with backlight
- Unit: m, ft, in
- Distance, area, volume and height measurement
- Continuous measuring mode to track maximum and minimum value
- Memory of 99 measurement values
- Automatic power off: laser 20s, main unit 150s

SPECIFICATION

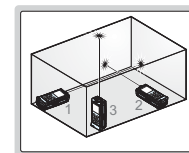
Code	9561-40	9561-80
Measuring range	0.05~40m	0.05~80m
Accuracy	$\pm(5.0+D/20)$ mm D: measured distance, unit: m	
Resolution	1mm, 10mm, .1", .01ft	
Measuring speed	0.5 second	
Laser type	635nm, class II, <1mW	
Power supply	3×AAA batteries, for 4000 measurements	
Dimension (L×W×H)	120×60×28mm	
Weight	175g	



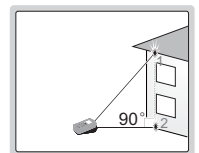
distance measurement



area measurement



volume measurement



height measurement

STANDARD DELIVERY

Main unit	1 pc
Battery (AAA)	3 pcs



VIDEO

INFRARED THERMOMETER CODE 9120-550

- With maximum reading
- Tolerance measurement
- Automatic power off

SPECIFICATION

Measuring range	-30~550°C/-22~1022°F
Accuracy	-30~0°C (-22~32°F): $\pm 3^{\circ}\text{C}$ 0~550°C (32~1022°F): $\pm(1.5\%+2^{\circ}\text{C})$
Resolution	0.1°C/0.1°F
Distance to spot ratio (D:S)	12:1
Emissivity	0.1~1 (adjustable)
Laser type	630~670nm, class II, <1mW
Response time	<0.5s
Power supply	2×1.5V AAA batteries
Dimension	155×110×45mm
Weight	126g (without batteries)

STANDARD DELIVERY

Main unit	1 pc
1.5V AAA battery	2 pcs



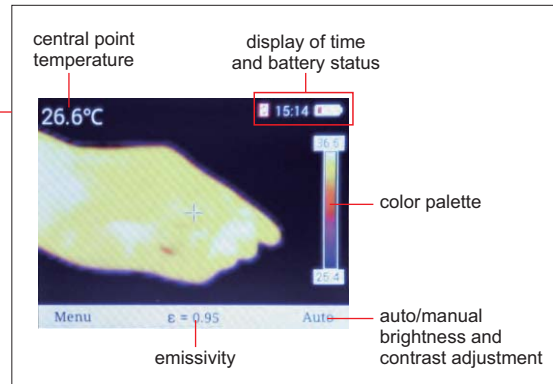
front view



INFRARED THERMAL IMAGING CAMERA (BASIC TYPE) CODE 9131-B350

IP43
WATERPROOF

DATA
OUTPUT



- Easy to use
- Four image presentations: IR, visible, PIP and MIF
- WIFI real-time sharing, one-click connection to mobile devices
- USB interface for data transmission and charging

SPECIFICATION

IR resolution	160×120
NETD	≤50mk
Focus length	5mm/F1.2
Angle of view	30°×23°
Spatial resolution	3.30mrad
Focus adjustment	fixed
Detector type	unrefrigerated vanadium oxide/8~14μm
Pixel size	17μm
Visible camera	resolution 640×480, automatic focus
Display	3.5" highlight LCD screen, 320×240
Image mode	IR image, visible image, MIF, PIP
Digital zoom	x2, x4
Color palette	6 modes
Temperature range	-20°C~350°C
Accuracy	±2°C or ±2% (of maximize range)
Emissivity	0.01-1.00 (adjustable)
Storage	SD card (16G)
Image format	JPG with temp info
Output	USB
Power	rechargeable Li-ion battery, working time≥4h
Operating temperature	-10°C~50°C
Operating humidity	10%~95%RH
Vibration	10HZ~150HZ~10HZ 0.15mm (IEC 60068-2-6)
Impact	30g (IEC 60068-2-27)
Weight	740g
Dimension	258x98x90mm



STANDARD DELIVERY

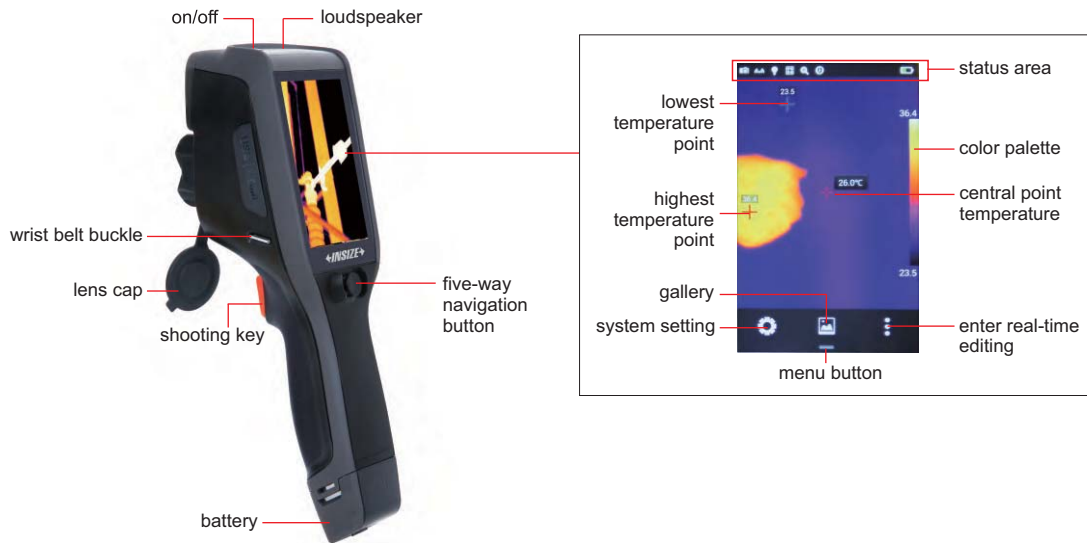
Main unit	1 pc
Power supply adapter	1 pc
USB cable	1 pc
16G SD card	1 pc



IP54
WATERPROOF

DATA
OUTPUT

INFRARED THERMAL IMAGING CAMERA CODE 9130-H360



- 4 inch high-brightness touchscreen
- Four image presentations: IR, visible, PIP and MIF
- WIFI real-time sharing, one-click connection to mobile devices
- USB interface for data transmission and charging
- Built-in illumination
- Video can be recorded and stored

SPECIFICATION

IR resolution	192×144
NETD	≤50mk
Focus length	7mm/F1.1
Angle of view	37.8°×28.8°
Spatial resolution	3.45mrad
Focus adjustment	focus-free
Detector type	unrefrigerated vanadium oxide/8~14μm
Pixel size	25μm
Visible camera	resolution 500W, focus-free
Display	4" highlight LCD touch screen, 480×800
Image mode	IR image, visible image, MIF, PIP
Digital zoom	1.1~4
Color palette	8 modes
Temperature range	-20°C~350°C
Accuracy	±2°C or ±2% (of maximize range)
Emissivity	0.01-1.00 (adjustable)
Storage	in camera and TF card (up to 32GB)
Image format	JPG with temp info
Output	USB, HDMI
Power	rechargeable Li-ion battery (7.4V), working time≥4h
Operating temperature	-10°C~50°C
Vibration	10HZ~150HZ~10HZ 0.15mm (IEC 60068-2-6)
Impact	30g 11ms (IEC 60068-2-27)
Weight	735g
Dimension	274x97x78mm



STANDARD DELIVERY

Main unit	1 pc
Power supply adapter	1 pc
USB cable	1 pc
HDMI cable	1 pc
Capacitive screen gloves	1 pc
TF card (16GB)	1 pc

FACE RECOGNITION THERMAL SCANNER 4 IN 1

- TEMPERATURE DETECTION
- MASK DETECTION
- TIME ATTENDANCE
- ACCESS CONTROL



ATF-1612

Code	Description
ATF-1612	With desk stand



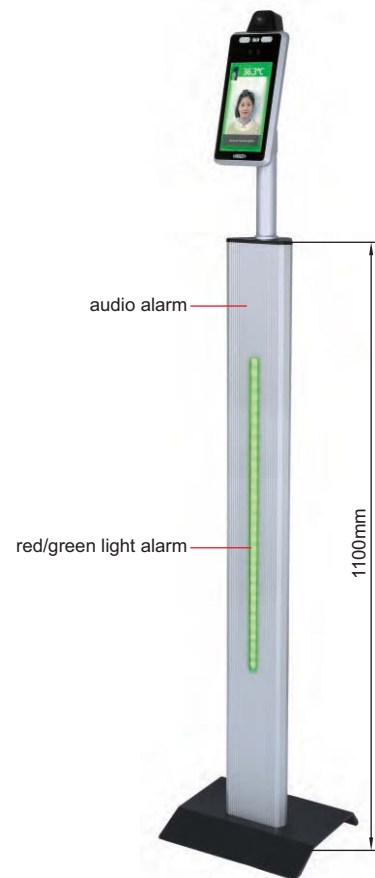
ATF-1612L

Code	Description
ATF-1612L	With floor stand for children



ATF-1612N

Code	Description
ATF-1612N	With mount for door control



ATF-1612H

Code	Description
ATF-1612H	With floor stand

To be continued



ATF-1612W

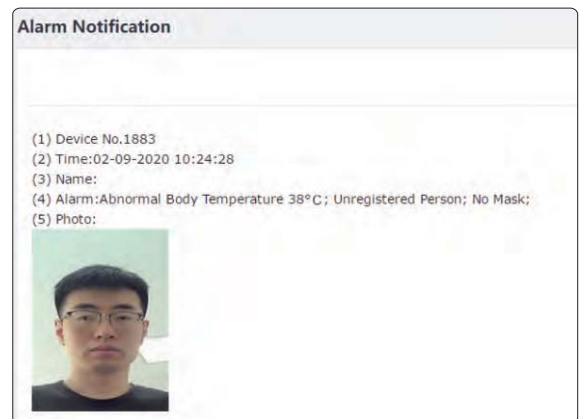
Code	Description
ATF-1612W	With wall-mount

Continued from previous page

- This device introduces a highly advanced built-in facial recognition algorithm and high resolution infrared thermal imaging camera. This brand new technology will identify someone by face, even while wearing a face mask. It locates the forehead and measures forehead temperature without touch. This device is the ideal solution for fully automatic contactless access control, time attendance, and temperature measurement.



can be connected with computer through WiFi



automatic email notification
(abnormal body temperature, no mask, unregistered person)

Features:

- **Access at a glance**
Walk through identification & authorization, no slowing down or stopping needed.
- **Contactless forehead temperature measurement**
High resolution infrared thermal imaging camera enhanced by an algorithm provides instant and high accuracy forehead temperature measurement with zero human involvement in less than 0.1 second.
The new technology comes pre-calibrated and has automatic temperature calibration through software and algorithm when the camera is turned on every time. This eliminates the need for a calibration system generally referred to as a black body. This eliminates not just added cost but human error when attempting to calibrate.
(1) To be used for initial temperature assessment for triage use in high throughput areas (e.g., airports, businesses, warehouses, factories) due to the high detection speed.
(2) Working distance is 0.5-1.2m and no operation needed, which can avoid inter infection.
(3) Captures photo of people when abnormal body temperature is detected, which can be used for tracing.
- **High accurate & reliable face ID**
Built-in world class facial recognition algorithm with dual cameras detects the identification in less than 0.2 seconds with the accuracy rate more than 99.9%. High performance face anti-spoofing technology can resist many kinds of presentation attack, such as, printed photo, the electronic display of a facial photo, replaying video using an electronic display and 3D face masks. Enhanced facial recognition algorithm can identify people even if they are wearing masks with the accuracy rate more than 90%.
- **Detect someone wearing or not wearing a mask**
- **Snapshot function can be disabled to protect privacy**

Use:

- This device is for indoor use only. It detects one person at a time.
- The device is used for initial temperature assessment. The final temperature should be confirmed with secondary evaluation methods (e.g., clinical grade contact thermometer).
- Select "Temperature", "Mask" and "Face recognition" as conditions to trigger alarm or to control door opening.
- For hospital / restaurant / hotel / retail store, etc., it can be used as thermal detector and/or mask detector. No need to input facial pictures in advance. It will alert you when the forehead temperature is above the preset target (for example, 37.3°C), for people with or without marks. It can also detect if people wear or not wear masks.
- A plant or school can have this set up at entrance for access control and time attendance, as well as temperature and mask detection. Input face pictures taken with a cell phone in advance for facial recognition. The readings can be monitored in an office.

To be continued

Continued from previous page

**time attendance record including staffs and visitors
(temperature documentation)**

	ID	Name	Gender	Age	Phone	Time	Temperature	Mask	
Visitor	1	001501	Anderson	0	29	-	2020/07/16-09:06:38	35.8°C	1
	2	001502	polo	0	30	-	2020/07/16-09:06:41	35.8°C	1
	3						2020/07/16-09:06:43	35.9°C	1
	4	001504	nich	1	30	-	2020/07/16-09:06:59	35.9°C	1
	5	001505	aimly	0	30	-	2020/07/16-09:07:11	35.8°C	1
	6	001506	hamer	1	28	-	2020/07/16-09:08:30	36.0°C	1
	7	001507	Aaron	0	32	-	2020/07/17-10:19:56	36.3°C	0
	8	001508	Barbara	0	30	-	2020/07/17-10:20:07	36.3°C	1
	9	001509	Robert	1	25	-	2020/07/17-10:20:19	36.3°C	1
	10	001510	Henry	1	30	-	2020/07/17-10:20:21	36.3°C	1
	11	001511	Nacy	0	27	-	2020/07/17-10:20:34	36.4°C	1
	12	001512	Mike	1	30	-	2020/07/17-10:20:37	35.5°C	1
	13	001513	Daisy	1	31	-	2020/07/17-10:20:39	36.3°C	1
	14	001514	Emma	0	31	-	2020/07/17-10:21:10	36.6°C	0
	15	001515	Jack	0	30	-	2020/07/17-10:21:13	36.3°C	1

SPECIFICATION

Operation system	Linux
Display	7 inch screen TFT
Speaker	voice prompt
Language	English, Spanish, etc.
Face database capacity	50K
Verification & identification speed	less than 0.1 second for thermal and less than 0.2 second for facial
Face anti spoofing	printed photo, electronic display of a facial photo, replaying video, 3D face masks, etc.
Facial recognition accuracy rate	>99.9%
Forehead thermometer range & accuracy	32°C~42°C, ±0.5°C
Work range	0.5~1.2m
Infrared thermal imaging camera	Uncooled infrared focal plane junction detectors array sensor Resolution: 160x120
Facial recognition camera	dual 1080p starlight CMOS sensors for visible light and near infrared light
Communication	RS232/485, TCP/IP, USB-Host, USB-Client, RJ45
Power supply	12V DC 2A
Ambient temperature	18°C~32°C

Application



school/campus



public transportation



airport



office



shopping mall



hospital



THERMOHYGROMETER CODE 9361-T65

- Measure humidity, ambient temperature, dew-point temperature and wet bulb temperature
- Min/Max/Average, data hold function
- Display backlight
- Auto power off

SPECIFICATION

Function	Measuring range	Resolution	Accuracy
Ambient temperature	-20°C~60°C/-4°F~140°F	0.1°C/0.1°F	±1°C/2°F
Wet bulb temperature	-20°C~60°C/-4°F~140°F		
Dew-point temperature	-10°C~50°C/14°F~122°F		
Humidity	0~99.9%RH	0.1%RH	±5%RH
Date storage	99 groups		
Auto power off	30 minutes		
Weight	190g		
Dimension	180×60×33mm		
Power supply	3×AAA battery		



STANDARD DELIVERY

Main unit	1 pc
Battery (AAA)	3 pcs



LUX METER CODE 9371-L110

- Measure visible light emitted by fluorescent lamps, metal halide lamps, high voltage sodium lamps or incandescent lamps
- Min/Max, data hold
- Two units: LUX and FC
- Reading in digital and analog
- Display backlight
- Auto power off

SPECIFICATION

Measuring range	0~200000LUX (0~20000FC)
Resolution	0.1LUX (range<1000LUX), 1LUX (range≥1000LUX) 0.01FC (range<100FC), 0.1FC (range<1000FC), 1FC (range≥1000FC)
Accuracy	±4%
LED type	standard light source, white LED, red LED, yellow LED, green LED, blue LED, purple LED
Sensor	silicon photo-diode and spectral response filter
Operating temperature	0°C~40°C
Operating humidity	<80%RH
Operating altitude	<2000m
Sampling rate	about 0.5 seconds
Spectral range	320~730nm
Auto power off	10 minutes
Dimension	190×60×33mm
Weight	180g
Power supply	3×AAA battery

sensor can rotate 180°



STANDARD DELIVERY

Main unit	1 pc
Battery (AAA)	3 pcs

DIGITAL ANEMOMETER CODE 9331-40

- Measure velocity, flow, temperature and relative humidity
- Velocity unit: m/s, km/h, mil/h, ft/m, ft/s, knots
- Flow unit: CMS (cubic meter per second), CMM (cubic meter per minute), CFM (cubic feet per minute)
- Temperature type: ambient, dew point, wet bulb
- Maximum and minimum modes
- Automatic power off



VIDEO



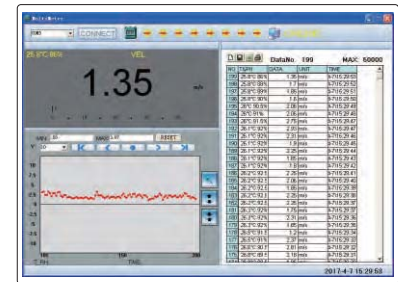
software CD
(included)



DATA
OUTPUT

SPECIFICATION

Measuring range	velocity	0.8~30m/s, 1.4~108km/h, 0.9~67.2mil/h, 1.3~98.5ft/s, 78~5900ft/m, 0.8~58.3knots
	flow	0~9999CMS, 0~99990CMM, 0~99990CFM
	temperature	-20~60°C/-4~140°F
	relative humidity	0~100%RH
Accuracy	velocity	±(2%+0.5) for m/s, km/h, mil/h, ft/s, knots ±(2%+50) for ft/m
	temperature	±1.5°C/±2.7°F
	relative humidity	±3% (20~80%RH), ±5% (<20%RH or >80%RH)
Resolution	velocity	0.01m/s, 0.01km/h, 0.01mil/h, 0.01ft/s, 1ft/m, 0.01knots
	flow	0.01CMS, 0.1CMM, 0.1CFM
	temperature	0.1°C/0.1°F
	relative humidity	0.1%RH
Flowing area range	0~9.999m ² /0~9.999ft ²	
Sampling time	0.4s	
Maximum working altitude	2000m	
Output	USB	
Power supply	9V battery	
Dimension	165×85×38mm	
Weight	200g	



software (included), display measurement values and graph, save and output data

STANDARD DELIVERY

Main unit	1 pc
Software and USB cable	1 pc
9V battery	1 pc

DIGITAL MOISTURE METER CODE 9341-50

- Suitable for wood, smooth cement, hard gypsum, mixed mortar, brick, etc.
- Measure moisture, temperature and relative humidity
- Temperature type: ambient, dew point, wet bulb
- Maximum and minimum modes
- Automatic power off



VIDEO

cover (included)



SPECIFICATION

Measuring depth	0~50mm	
Measuring range	moisture	0~60%
	temperature	-10~50°C/14~122°F
	relative humidity	0~100%RH
Accuracy	moisture	±2%
	temperature	±2%
	relative humidity	±5%RH
Resolution	moisture	0.1%
	temperature	0.1°C/0.1°F
	relative humidity	0.1%RH
Sampling time	0.5s for moisture 1s for temperature and relative humidity	
Power supply	2×AAA batteries	
Dimension	130×56×29mm	
Weight	206g	

STANDARD DELIVERY

Main unit	1 pc
Battery (AAA)	2 pcs

DATA
OUTPUT

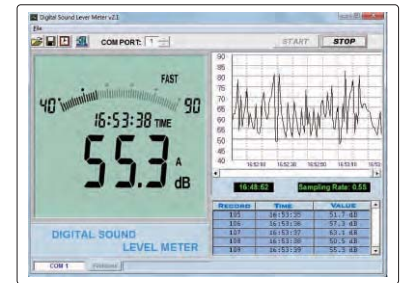
DIGITAL SOUND LEVEL METER CODE 9351-130



- Automatically select best range: 30~80dB, 40~90dB, 50~100dB, 60~110dB, 70~120dB, 80~130dB
- Over range indicator
- Real time, average, maximum modes
- Memory 16000 measurement values
- AC signal output: 0.707 Vrms at FS, impedance approx. 600Ω
- DC signal output: 10mV/dB, impedance approx. 100Ω
- Automatic power off

SPECIFICATION

Measuring range	30~130dB
Accuracy	±2dB
Resolution	0.1dB
Sampling time	0.5s for digital, 0.05s for analogue
Response time	fast: 125ms, slow: 1s
Frequency	30Hz~8KHz
Frequency weighting	A/C
Microphone	electret condenser type
Output	RS232, AC/DC
Power supply	6×AAA batteries
Dimension	265×80×69mm
Weight	317g



software (included), display measurement values and graph, save and output data

STANDARD DELIVERY

Main unit	1 pc
RS232 cable and software	1 pc
Output connector	1 pc
Battery (AAA)	6 pcs



software CD
(included)



NON-CONTACT DIGITAL TACHOMETER CODE 9221-999

- Maximum and minimum modes
- Memory 100 measurement values
- Automatic power off

SPECIFICATION

Measuring range	50~99999RPM
Accuracy	±(0.03%+2) RPM
Resolution	0.01RPM (range 50~99.99RPM)
	0.1RPM (range 100~9999.9RPM)
	1RPM (range 10000~99999RPM)
Measuring distance	50~250mm
Power supply	4×AAA batteries
Dimension	155×60×27mm
Weight	118g



reflection sticker (included)



STANDARD DELIVERY

Main unit	1 pc
Reflection sticker	1 roll
Battery (AAA)	4 pcs

CONTACT DIGITAL TACHOMETER CODE 9222-199



- Unit: RPM, m/min, m/sec, ft/min, ft/sec, in/min
- Maximum and minimum modes
- Memory 100 measurement values
- Automatic power off



wheel with 0.1m perimeter (included)



wheel with 6" perimeter (included)



extension rod (included)



cone cavity head (included)



cone head (included)

SPECIFICATION

Measuring range	50~19999RPM
Accuracy	±(0.03%+2) RPM
Resolution	0.01RPM (range 50~99.99RPM)
	0.1RPM (range 100~9999.9RPM) 1RPM (range 10000~19999RPM)
Power supply	4×AAA batteries
Dimension	183×60×27mm
Weight	122g

STANDARD DELIVERY

Main unit	1 pc
Wheel with 0.1m perimeter	1 pc
Wheel with 6" perimeter	1 pc
Cone cavity head	1 pc
Cone head	1 pc
Extension rod	1 pc
Battery (AAA)	4 pcs

VIBRATION PEN CODE 9720-199



- Measure vibration of motors, fans, pumps, compressors and machine tools to prevent mechanical failure
- Small size, light weight, low energy consumption, easy operation, easy to carry
- One key control
- Automatic power off



SPECIFICATION

Code	9720-199
Measured parameter	speed
Measuring range	0.1~199.9mm/s
Frequency	10Hz~1KHz
Accuracy	±(5%±2)mm/s
Operating temperature	0°C~40°C
Operating humidity	< 85%
Power supply	2×LR44 batteries (for 10 hours working)
Dimension	150x22x18mm
Weight	55g

STANDARD DELIVERY

Main unit	1 pc
LR44 battery	2 pcs



PEN-TYPE DIGITAL MULTIMETER CODE 9241-ML200

- Automatic ranging
- Maximum mode
- Data hold
- Low battery display
- Auto power off
- Safety rating: CAT III 600V



probe (included)



clips (included)



SPECIFICATION

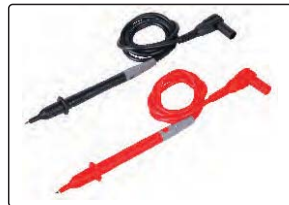
Function	Range	Resolution	Accuracy
DC Voltage	200mV/2V/20V/200V/600V	0.1mV/1mV/10mV/0.1V/1V	$\pm(0.7\%+2)$
	200mV/2V/20V/200V	0.1mV/1mV/10mV/0.1V	$\pm(0.8\%+3)$
AC Voltage	600V	1V	$\pm(1.0\%+3)$
	20mA/200mA	10 μ A/0.1mA	$\pm(1.5\%+3)$
DC Current	20mA/200mA	10 μ A/0.1mA	$\pm(2.0\%+3)$
AC Current	200 Ω	0.1 Ω	$\pm(1.0\%+3)$
	2k Ω /20k Ω /200k Ω /2M Ω	1 Ω /10 Ω /0.1k Ω /1k Ω	$\pm(1.0\%+1)$
	20M Ω	10k Ω	$\pm(1.0\%+5)$
Logic level test	<1.5V (green LED on)		
	1.5~3.5V (green & red LED off)		
	>3.5V (red LED on)		
Diode	open circuit voltage 1.5V		
Continuity buzzer	<50 Ω		
Power supply	2×1.5V AAA batteries		

STANDARD DELIVERY

Main unit	1 pc
Probe	1 pc
Clip	2 pcs
1.5V battery	2 pcs

DIGITAL MULTIMETER CODE 9242-ML100

- Data hold
- Display backlight
- Low battery display
- Safety rating: CAT II 600V



probes (included)



SPECIFICATION

Function	Range	Resolution	Accuracy
DC Voltage	200mV/2V/20V/200V	0.1mV/1mV/10mV/0.1V	$\pm(0.5\%+3)$
	600V	1V	$\pm(0.8\%+5)$
AC Voltage	200V/600V	0.1V/1V	$\pm(1.2\%+10)$
	200 μ A/2mA	0.1 μ A/1 μ A	$\pm(1.0\%+3)$
DC Current	20mA	10 μ A	$\pm(1.0\%+5)$
	200mA	0.1mA	$\pm(1.5\%+5)$
	10A	10mA	$\pm(3.0\%+10)$
	200 Ω	0.1 Ω	$\pm(0.8\%+5)$
Resistance	2k Ω /20k Ω /200k Ω	1 Ω /10 Ω /0.1k Ω	$\pm(0.8\%+2)$
	2M Ω	1k Ω	$\pm(1.0\%+5)$
	Diode	open circuit voltage 3.0V	
Continuity buzzer	<70 \pm 30 Ω		
Transistor hFE	measuring range 0~1000		
Power supply	1×9V 6F22/NEDA 1604 battery		

STANDARD DELIVERY

Main unit	1 pc
Probe	2 pcs
9V battery	1 pc

AC DIGITAL CLAMP METER CODE 9243-CA600

- Auto/manual ranging
- Maximum mode
- Data hold
- Display backlight
- Work light
- Low battery display
- Auto power off
- Safety rating: CAT III 600V



probes (included)



SPECIFICATION

Function	Range	Resolution	Accuracy
DC Voltage	200mV/2V/20V/200V	0.1mV/1mV/10mV/0.1V	±(0.8%+2)
	600V	1V	±(1.0%+2)
AC Voltage	2V/20V/200V	1mV/10mV/0.1V	±(1.0%+5)
	600V	1V	±(1.2%+5)
AC Current	2A(≤0.5A)	1mA	±(3.5%+20)
	2A	1mA	±(3.0%+10)
	20A	10mA	±(3.0%+10)
	200A	0.1A	±(2.5%+10)
	600A	1A	±(1.5%+5)
Resistance	200Ω/2kΩ/20kΩ/200kΩ/2MΩ	0.1Ω/1Ω/10Ω/0.1kΩ/1kΩ	±(1.2%+2)
	20MΩ	10kΩ	±(2.0%+5)
Diode	open circuit voltage 1.5V		
Continuity buzzer	<50Ω		
Power supply	3×1.5V AAA batteries		
Dimension	208×78×35mm		
Weight	245g		

STANDARD DELIVERY

Main unit	1 pc
Probe	2 pcs
1.5V battery	3 pcs

60° GLOSS METER CODE ISQ-DG6



- To test the gloss of coating, such as painting, varnish, printing ink, etc.
- To test the material surfaces, such as metal, granite, ceramic, plastic, paper, etc.
- According to ISO 2813, ASTM D2457, ASTM D523
- Automatic power off



base with calibration block
(included)

SPECIFICATION

Incidence angle	60°
Measuring range	0~150GU
Resolution	0.1GU
Accuracy	±1.2GU
Repeatability	0.4GU
Zero set error	0.2GU
Measuring area	20×10mm
Power supply	1×1.5V AA battery
Dimension	123×38×65mm
Weight	300g

STANDARD DELIVERY

Main unit	1 pc
Base with calibration block	1 pc
Spare calibration block	1 pc



DATA
OUTPUT

BLUETOOTH

CAN BE OPERATED BY
COMPUTERS OR MOBILE PHONES

20°/60°/85° GLOSS METER CODE ISQ-DG8



base with calibration block
(included)



software CD
(included)

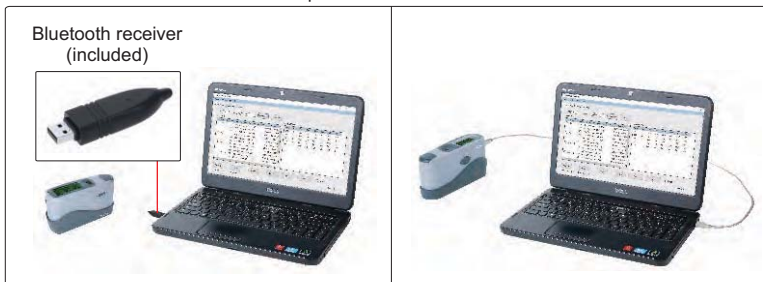
- To test the gloss of coating, such as painting, varnish, printing ink, etc.
- To test the material surfaces, such as metal, granite, ceramic, plastic, paper, etc.
- According to ISO 2813, ASTM D2457, ASTM D523
- Memory of 10000 measurement results for browsing and output
- Automatic power off

connect mobile phone via bluetooth
(only Android system)



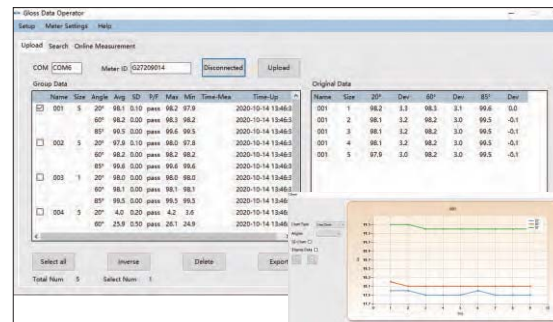
operate and output data by mobile phone

connect computer via bluetooth or USB cable



SPECIFICATION

Incidence angle	20°	60°	85°
Measuring range	0~2000GU	0~1000GU	0~160GU
Resolution	0.1GU (range≤119.9GU) 1GU (range>119.9GU)		
Accuracy	±1.5GU (range≤119.9GU) ±1.5% (range>119.9GU)		
Repeatability	0.2GU (range≤119.9GU) 0.2% (range>119.9GU)		
Zero set error	0.2GU		
Measuring area	10×9mm	16×9mm	39×5mm
Output	USB and bluetooth		
Power supply	1×1.5V AA battery		
Dimension	155×48×75mm		
Weight	400g		



software (included), test can be controlled from the software,
display test data, output to Excel

STANDARD DELIVERY

Main unit	1 pc
Base with calibration block	1 pc
Software and USB cable	1 pc
Bluetooth receiver	1 pc

SPECTROPHOTOMETER CODE 9710-30



- Concave grating spectrophotometric
- 3.5 inch TFT color LCD, capacitive touch screen, 256 image element double arrays CMOS image sensor
- D/8 geometrical optics, conforms with CIE No.15, GB/T 3978, GB2893, GB/T 18833, ISO7724/1, ASTM E1164, DIN5033 Teil
- Use long life and low power consumption combined LED light source
- Camera locating function, switchable 8mm/4mm aperture, support both SCI and SCE at the same time
- Large capacity storage space, over 20,000 measurement data
- USB port and Bluetooth 4.0
- Two standard observer angles, a variety of illuminant, a variety of color indexes, conforms with a variety of standard colorimetric data,
- Measure sample spectra, accurate Lab data , can be used in color matching and accurate color transmission

DATA
OUTPUT

CONCAVE GRATING
SPECTROPHOTOMETRIC

Ø8/4mm DUAL APERTURE

BLUETOOTH



software CD
(included)



white and black calibration
cavity (included)



printer (optional)

SPECIFICATION

Optical geometry	reflect: di: 8°, de: 8° (diffused illumination, 8-degree viewing angle)
Integrating sphere size	Ø48mm
Light source	combined LED light, UV light
Spectrophotometric mode	concave grating
Sensor	256 image element double array CMOS image sensor
Wavelength range	400~700nm
Wavelength interval	10nm
Semiband width	10nm
Measured reflectance range	0~200%
Measuring aperture	dual aperture: MAV: Ø8mm; SAV: Ø4mm
Specular component	SCI&SCE
Color space	CIE LAB, XYZ, Yxy, LCh, CIE LUV, Hunter LAB
Color difference formula	ΔE^*ab , ΔE^*uv , ΔE^*94 , ΔE^*cmc (2:1), ΔE^*cmc (1:1), ΔE^*00v , ΔE (Hunter)
Other colorimetric index	WI (ASTM E313, CIE/ISO, AATCC, Hunter), YI (ASTM D1925, ASTM 313), Metamerism index MI, Staining fastness, Color fastness, Colorstrength, Opacity
Observer angle	2°/10°
Illuminant	A, C, D50, D55, D65, D75, F1, F2, F3, F4, F5, F6, F7, F8, F9, F10, F11, F12, CWF, U30, T183, T184, U35
Displayed data	spectrogram/values, samples chromaticity values, color difference values/graph, PASS/FAIL result, color offset
Measuring time	2.6s
Repeatability	spectral reflectance
	colorimetric values
Inter-instrument error	MAV/SCI: within 0.08% of standard deviation (400~700nm: 0.18%)
Measurement mode	MAV/SCI: $\Delta E^* \leq 0.03$
Measurement mode	MAV/SCI: $\Delta E^* \leq 0.15$
Measurement mode	single measurement, average measurement
Data port	USB, Bluetooth 4.0
Data storage	standard 1000 pcs, sample 28000 pcs
Illuminant life span	5 years, more than 3 million times measurements
Battery	Li-ion battery, 5000 measurements within 8 hours
Dimension	184×77×105mm
Weight	600g



measurement



reflectivity

software

report

measurement data is exported to EXCEL

software (included), test can be controlled from the software, display test data, report

STANDARD DELIVERY

Main unit	1 pc
White and black calibration cavity	1 pc
Software and USB cable	1 pc
AC/DC adapter	1 pc

OPTIONAL ACCESSORY

Printer	9710-PRINTER
Powder test box	9710-POWDERBOX
Universal test kit	9710-TESTKIT

DIGITAL LED TACHOMETER/STROBOSCOPE CODE ISQ-TS120K



- Make cyclical motion (rotation, vibration, etc.) objects to appear slow-moving or stationary
- On-line inspection or observation for moving objects
- Measure the rotation or vibration speed and frequency
- Can be triggered from outside by moving objects, make LED flash frequency same as the rotation or vibration

SPECIFICATION

Flash frequency range	60~120000FPM (Flash Per Minute), 1~2000Hz	
Resolution	FPM	0.1FPM (<100000FPM), 1FPM (≥100000FPM)
	HZ	0.01Hz (<200Hz), 0.1Hz (≥200Hz)
Setting accuracy	±0.01%	
Phase shift increment	3°	
Flash pulse duration time	0.1~2.5°	
LED light	3 pcs CREE 10W lamp	
LED life	3~5 years	
Trigger mode	internal and external	
Power supply	built-in rechargeable battery or AC/DC adapter	
Dimension	208×70×60mm	
Weight	380g	



proximity trigger (included)



make LED flash frequency same as the rotation or vibration (power supply from AC/DC adapter when external trigger is used)

STANDARD DELIVERY

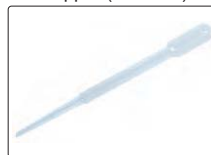
Main unit	1 pc
AC/DC adapter	1 pc
Proximity trigger	1 pc

- Quickly measure the concentration of coolant
- Two measurement modes: single measurement and automatic average multiple measurement
- Two units: brix and refractive index
- Refer to the refraction factor of coolant, for example: the refraction factor of grinding emulsion is 2.1, the reading value is 6%, so the actual concentration is $(2.1 \times 6\%) = 12.6\%$
- Automatic power off

SPECIFICATION

Measuring range	0~50% (1.3330~1.4200RI)
Accuracy	±0.2% (±0.0003RI)
Resolution	0.1% (0.0001RI)
Power supply	1×AAA battery
Dimension	121×58×25mm
Weight	90g

dropper (included)



STANDARD DELIVERY

Main unit	1 pc
Dropper	1 pc
Battery (AAA)	1 pc

DIGITAL REFRACTOMETER CODE ISQ-DRM31

SUITABLE FOR WATER BASED COOLANT



SUITABLE FOR WATER BASED COOLANT



- Quickly measure the concentration of coolant
- Refer to the refraction factor of coolant, for example: the refraction factor of grinding emulsion is 2.1, the reading value is 6%, so the actual concentration is $(2.1 \times 6\%) = 12.6\%$

SPECIFICATION

Measuring range	0~32%
Graduation	0.2%
Dimension	27×40×160mm
Weight	175g

PORTABLE REFRACTOMETER CODE ISQ-RM30



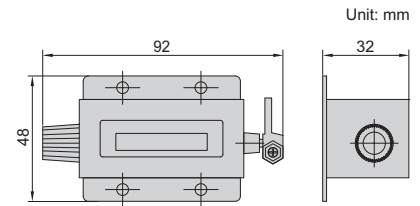
STROKE COUNTER CODE 7600-6

- Accumulate and record the number of mechanical movements
- Rotate back to zero



SPECIFICATION

Code	Number of digits	Range
7600-6	6	0-999999



DIGITAL LEVEL CODE ISE-2DT

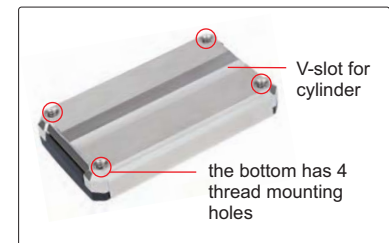
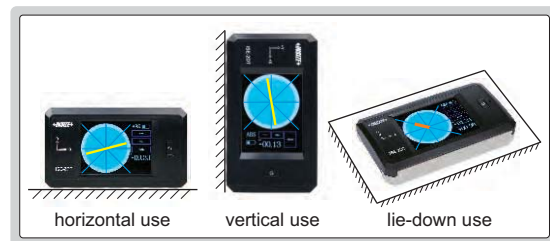
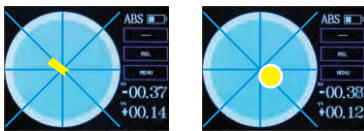
DATA
OUTPUT

- Color LCD, touch panel
- X-Y axis measurement
- Set the tolerance and the display is shown in different colors



within the tolerance (green) slightly out of the tolerance (yellow) seriously out of the tolerance (red)

- To show the incline with line or bubble



SPECIFICATION

Measuring range	±30°
Resolution	0.01°, 0.1mm/m
Accuracy	±0.03° (range 0~3°) ±0.05° (range >3°)
Power supply	rechargeable battery
Dimension	115×66×23mm
Weight	224g

STANDARD DELIVERY

Main unit	1 pc
USB cable	1 pc

OPTIONAL ACCESSORY

Software	ISE-2DT-SOFTWARE
----------	------------------



IP67
WATERPROOF

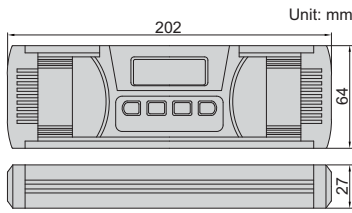
ABSOLUTE LEVEL

BACKLIGHT

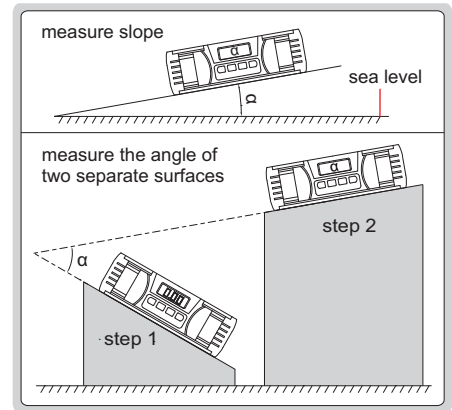
BUZZER ALARM AT 0° AND 90°

WORKING TEMPERATURE -5°C ~ 50°C

DIGITAL LEVEL AND SLOPE METER



2175-360



- IP67 dust/waterproof
- Used as level and slope meter
- Aluminum frame, shock absorbing rubber end caps
- Magnetic bottom with V-groove for shafts
- The sea level is permanently set inside the chip, zero setting is not needed when batteries are replaced
- Buttons: ON/OFF, backlight/buzzer alarm, absolute and incremental measurement, unit (mm/m, %, °), HOLD (keep the reading)
- Three AAA batteries, automatic power off

Code	Range	Resolution	Accuracy
2175-360	0-360° (90°x4)	0.05° (=0.873mm/m)	at 0°: ±0.05°; at others: ±0.1°

IP54
WATERPROOF

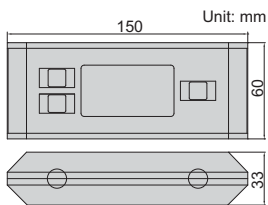
ABSOLUTE LEVEL

BACKLIGHT

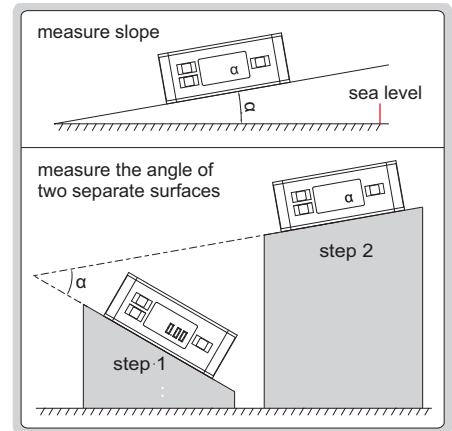
BUZZER ALARM AT 0° AND 90°

WORKING TEMPERATURE -5°C ~ 50°C

DIGITAL LEVEL AND SLOPE METER



2179-360



- IP54 dust/waterproof
- Used as level and slope meter
- Aluminum frame
- Magnetic bottom with V-groove for shafts
- The sea level is permanently set inside the chip, zero setting is not needed when battery is replaced
- Buttons: ON/OFF, absolute and incremental measurement, keep the reading, buzzer alarm, unit (mm/m, %, in/ft), conversion, backlight
- Two AAA batteries, automatic power off

Code	Range	Resolution	Accuracy
2179-360	0-360° (90°x4)	0.05° (=0.873mm/m)	at 0° and 90°: ±0.1°; at others: ±0.2°

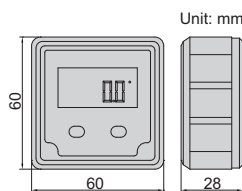
DISPLAY FLIPS OVER WHEN THE BOTTOM FACES UP

WORKING TEMPERATURE -5°C ~ 50°C

BACKLIGHT

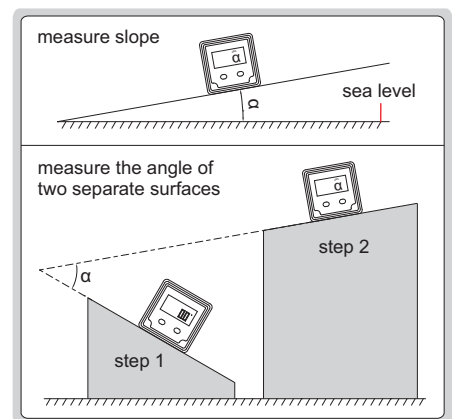
ABSOLUTE LEVEL

MAGNETIC BOTTOM



2170-1

DIGITAL LEVEL AND SLOPE METER



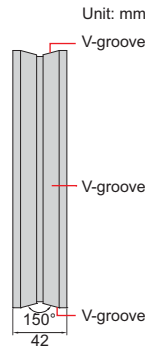
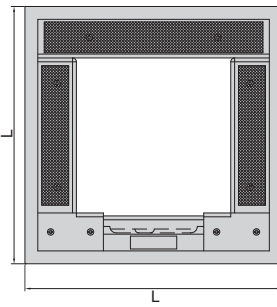
- Used as level and slope meter
- Aluminum frame
- Magnetic bottom
- The display flips over when the bottom faces up
- The backlight is on automatically when in use, and automatically off in 15 seconds after use
- The sea level is permanently set inside the chip, zero setting is not needed when battery is replaced
- Buttons: ON/OFF, ZERO, absolute and incremental measurement
- One AAA battery, automatic power off in 5 minutes

Code	Range	Resolution	Accuracy
2170-1	4x90°	0.1° (=1.745mm/m)	at 0° and 90°: ±0.1°; at others: ±0.2°

FRAME LEVELS

INSIZE PLUS
MADE IN EUROPE

- No need to set zero before use
- Three V-grooves for shafts (shafts dia. 19.3~115.9mm)
- With longitudinal vial



NO NEED TO SET ZERO BEFORE USE



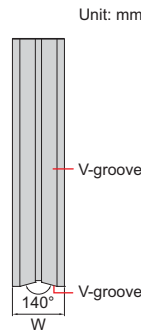
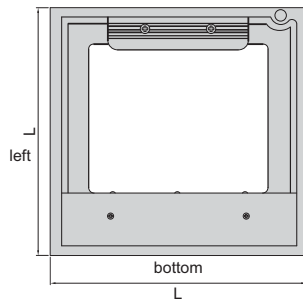
4906-200

Code		Size (LxL)
Sensitivity 0.02mm/m (=0.001°)	Sensitivity 0.1mm/m (=0.0057°)	
4906-150	4906-B150	150x150mm
4906-200	4906-B200	200x200mm
4906-300	4906-B300	300x300mm

FRAME LEVELS (ECONOMIC TYPE)



- V-groove on bottom and left for shafts (shafts dia. 15~70mm)
- With transverse vial
- Supplied with adjusting wrench



4902-200

Code		Size (LxL)	W
Sensitivity 0.02mm/m (=0.001°)	Sensitivity 0.05mm/m (=0.0029°)		
4902-150	4902-C150	150x150mm	40mm
4902-200	4902-C200	200x200mm	40mm
4902-300	4902-C300	300x300mm	45mm

BLOCK LEVELS

INSIZE PLUS
MADE IN EUROPE

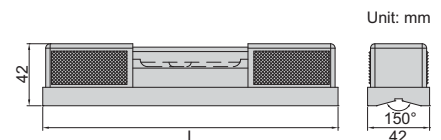
- No need to set zero before use
- V-groove on bottom for shafts (shafts dia. 19.3~115.9mm)
- With longitudinal vial



4905-200

NO NEED TO SET ZERO BEFORE USE

Code		Size (L)
Sensitivity 0.02mm/m(=0.001°)	Sensitivity 0.1mm/m(=0.0057°)	
4905-160	4905-B160	160mm
4905-200	4905-B200	200mm
4905-300	4905-B300	300mm
4905-500	4905-B500	500mm



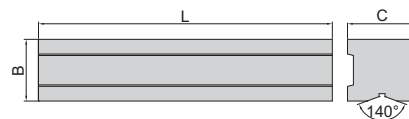


BLOCK LEVELS (ECONOMIC TYPE)



4903-200A

- V-groove on bottom for shafts (shafts dia. 15~70mm)
- With transverse vial
- Supplied with adjusting wrench



Code		Length (L)	B	C
Sensitivity 0.02mm/m (=0.001°)	Sensitivity 0.05mm/m (=0.0029°)			
4903-150A	4903-C150	150mm	40mm	45mm
4903-200A	4903-C200	200mm	42mm	47mm
4903-300A	4903-C300	300mm	45mm	50mm

NO NEED TO SET ZERO BEFORE USE

- No need to set zero before use
- Suitable for small spaces like crankshaft
- Longitudinal and transverse V-grooves on bottom for shafts (shafts dia. 19.3~115.9mm)
- With transverse vial

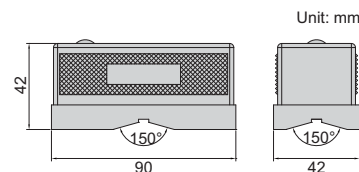


4907-90

Code	Length	Sensitivity
4907-90	90mm	0.1mm/m (=0.0057°)

SHORT LEVEL

INSIZE PLUS
MADE IN EUROPE



NO NEED TO SET ZERO BEFORE USE

- No need to set zero before use
- With mounting holes (for M5 screws)

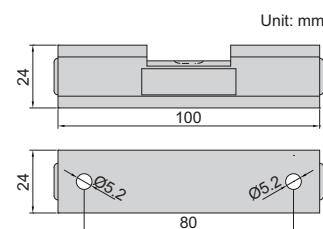


4908-100

Code	Length	Sensitivity
4908-100	100mm	0.1mm/m (=0.0057°)

MINI LEVEL

INSIZE PLUS
MADE IN EUROPE



MACHINISTS' LEVELS

- With transverse and longitudinal vials
- V-groove on bottom for shafts (shafts dia. 15-60mm for 4904-150, and 15-70mm for 4904-200/300)
- Supplied with adjust wrench

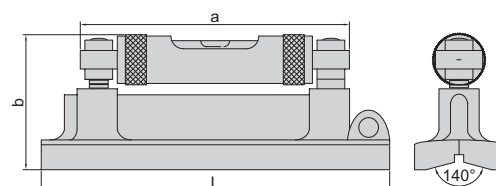


4904-200

rotate cover to protect vials



Code	Sensitivity	Size (L)	a	b
4904-150	0.3mm/m (=0.017°)	150mm	116mm	58mm
4904-200	0.3mm/m (=0.017°)	200mm	135mm	73mm
4904-300	0.3mm/m (=0.017°)	300mm	216mm	73mm

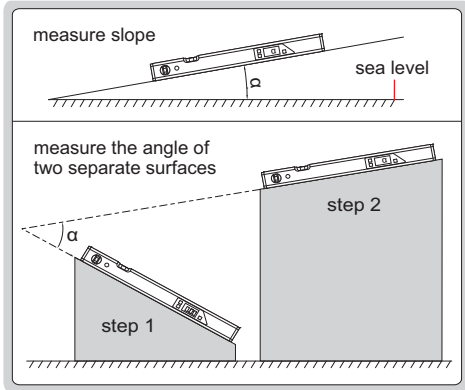


DIGITAL LEVELS AND SLOPE METERS

ABSOLUTE LEVEL

BACKLIGHT

WORKING TEMPERATURE
0°C ~ 50°C

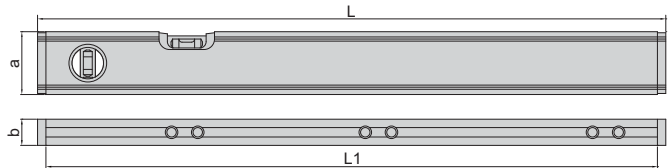


4910-400



4910-600

- With transverse and longitudinal vials
- Used as level and slope meter
- Aluminum frame, magnetic bottom
- The sea level is permanently set inside the chip, zero setting is not needed when batteries are replaced
- Buttons: ON/OFF, absolute and incremental measurement, keep the reading, buzzer alarm (not for 4910-400), unit (mm/m, %, in/ft), conversion (not for 4910-400), backlight
- The display flips over when the bottom faces up
- Two AAA batteries
- Automatic power off



(mm)

Code	Range	Resolution	Accuracy	Remark	L	L1	a	b
4910-400	0~360° (90°×4)	angle: 0.1°; slope: 1mm/m	±0.2°	both angle and slope are displayed	416	400	50	21
4910-600	0~360° (90°×4)	at 0° and 90°: 0.05° (=0.8725mm/m); at others: 0.1° (=1.745mm/m)	at 0° and 90°: ±0.1°; at others: ±0.2°	at 0° and 90° buzzer alarms	600	585	60	25

ALUMINUM ALLOY LEVELS

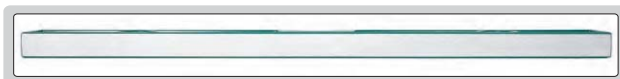
LIFETIME WARRANTY VIALS

- Top and bottom working surfaces
- Shock-proof and UV-proof vials
- Die casting aluminum alloy frame
- Zero position of horizontal vial can be set
- One graduation of horizontal vial is 2% slope
- Working temperature: -15°C~55°C

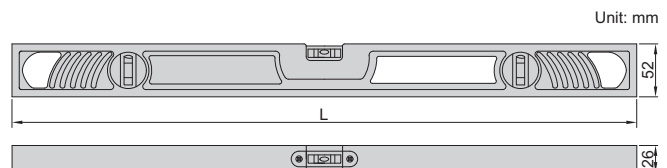


4911-600

bottom surface (non-magnetic, milled)



Code	Length (L)	Accuracy
4911-600	600mm	0.5mm/m
4911-800	800mm	0.5mm/m



MAGNETIC BASE

LIFETIME WARRANTY VIALS

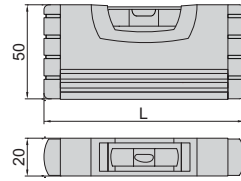
HANDY LEVEL

magnetic base surface



4912-100

Unit: mm



packaging



- Shockproof vials
- Magnetic base
- Shock absorbing rubber end caps
- Working temperature: -15°C~55°C

Code	Size (L)	Accuracy
4912-100	100mm	0.5mm/m

MAGNETIC BASE

LIFETIME WARRANTY VIALS

CASTING ALUMINUM LEVEL

magnetic bottom surface (milled)



4913-250

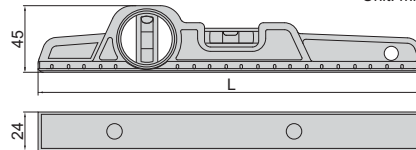
packaging



- Shockproof horizontal and vertical vials
- Magnetic base
- Working temperature: -15°C~55°C
- Casting aluminum body

Code	Size (L)	Accuracy
4913-250	250mm	0.5mm/m

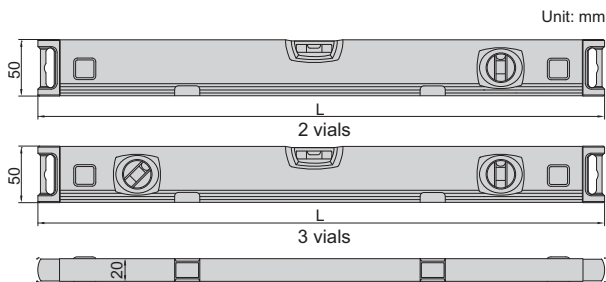
Unit: mm



LIFETIME WARRANTY VIALS

MAGNETIC BASE

ALUMINUM LEVELS



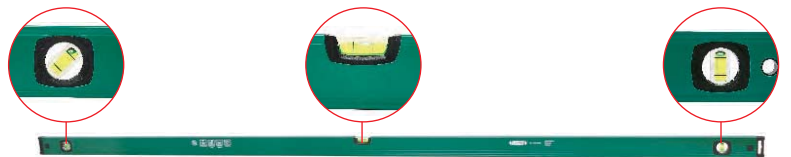
Unit: mm



4914-600

- Shockproof horizontal and vertical vials
- Magnetic base
- Shock absorbing rubber end caps
- Working temperature: -15°C~55°C

Code	Size (L)	Accuracy	Number of vials
4914-300	300mm	0.5mm/m	2
4914-600	600mm	0.5mm/m	2
4914-800	800mm	0.5mm/m	2
4914-1000	1000mm	0.5mm/m	2
4914-1200	1200mm	0.5mm/m	2
4914-2000	2000mm	0.5mm/m	3



4914-2000

magnetic bottom surface (milled)



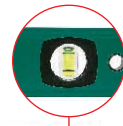
ALUMINUM ALLOY LEVELS (BASIC TYPE)

MAGNETIC BASE

LIFETIME WARRANTY VIALS



4918-300



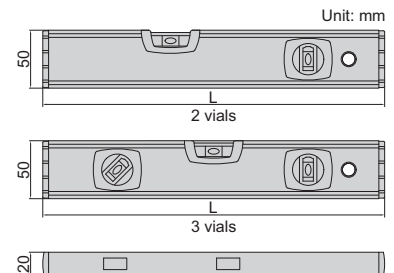
4918-2000

magnetic bottom surface



- Shock-proof and UV-proof vials
- Magnetic base
- Shock absorbing rubber end caps
- Working temperature: -15°C~55°C

Code	Size (L)	Accuracy	Number of vials
4918-300	300mm	1mm/m	2
4918-600	600mm	1mm/m	2
4918-800	800mm	1mm/m	2
4918-1000	1000mm	1mm/m	2
4918-1200	1200mm	1mm/m	2
4918-2000	2000mm	1mm/m	3



CROSS-LINE LASER LEVEL CODE 4917-30



IP54
WATERPROOF

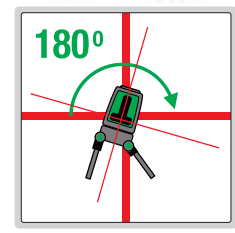
AUDIBLE AND VISUAL
WARNING WHEN OUT OF ±3°

- Red horizontal and vertical cross laser lines
- Self-leveling within ±3°, self-leveling time within 4s, audible and visual warning when out of ±3°
- Folding legs for angle and height adjustment
- Outdoor use with the detector (code: 4917-DETECTOR)

application examples



folding legs for angle
and height adjustment



SPECIFICATION

Laser line width	2±0.5mm (within 5m)
Laser type	630~660nm, class II, <1mW
Beam angle	120±0.5°
Self-leveling range	±3°
Working distance	indoor: 30m, outdoor: 50m with detector (optional)
Accuracy	0.2mm/m
Operation temperature	-10~40°C
Power supply	3×AA batteries, for 3 hours working
Dimension	100×82×104mm
Weight	620g

STANDARD DELIVERY

Main unit	1 pc
1/4" to 5/8" tripod adaptor	1 pc
Battery (AA)	3 pcs

OPTIONAL ACCESSORY

Outdoor detector	4917-DETECTOR
------------------	---------------

OUTDOOR DETECTOR (OPTIONAL)

Detecting distance	horizontal 1~50m, vertical 1~30m
Detecting accuracy *	high accuracy ±1.5mm, low accuracy ±2.5mm
Power supply	9V battery
Dimension	168×58×30mm
Weight	140g (battery included)

* Use high accuracy detection mode within 15m, use low accuracy detection mode over 15m



outdoor detector (optional)



stand
(included with outdoor detector)

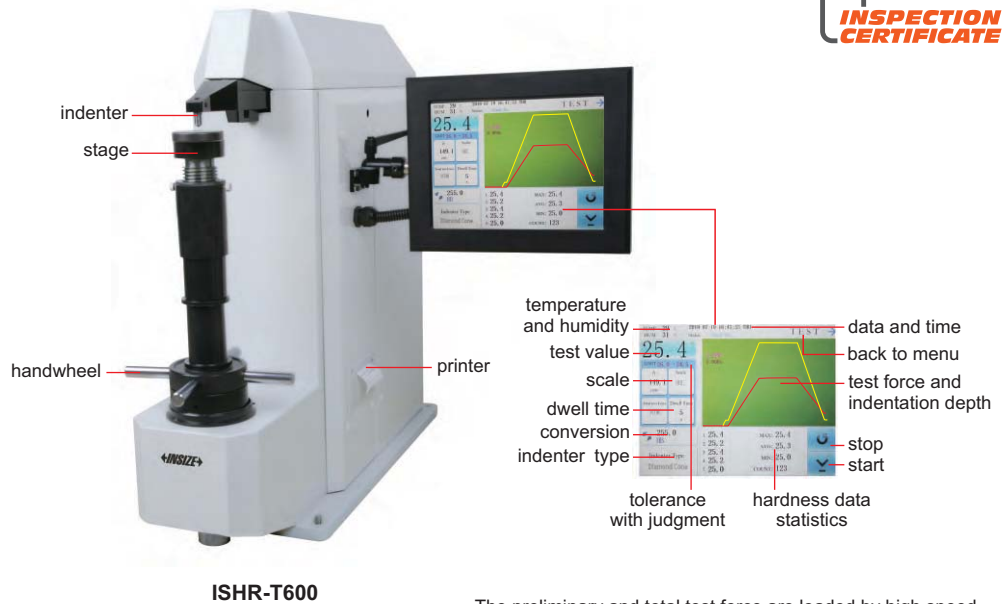
FORCE LOADING BY CLOSE-LOOP SYSTEM (WITHOUT WEIGHTS)

AUTOMATIC TESTING, CONTINUOUS TESTING



AUTOMATIC DIGITAL ROCKWELL/SUPERFICIAL ROCKWELL HARDNESS TESTERS (DOLPHIN-NOSE TYPE)

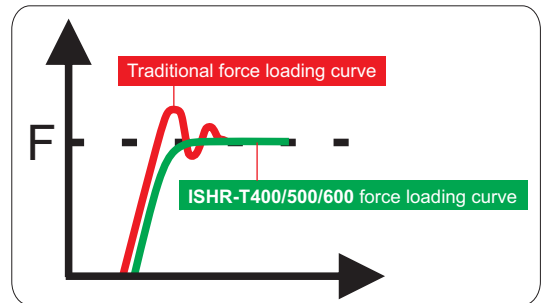
INSPECTION CERTIFICATE



ISHR-T600

- Automatic testing, the preliminary and total test force are loaded by high speed close-loop system automatically
- Dolphin-nose indenter for easy reach of the internal wall of pipes and grooves, the minimum internal diameter is 40mm
- Can transmit test data to computer
- LCD touch screen
- Tolerance with judgement
- Memory of 120 test values for browsing and output
- Provide the maximum, minimum and average values of measurement
- The test process curve shows the material property
- Test force is selected automatically according to hardness scale

The preliminary and total test force are loaded by high speed close-loop system automatically, faster and more stable than traditional motor loading. Loading process is smooth, no overshoot. Loading speed and accuracy are improved greatly



SPECIFICATION

Code	ISHR-T400	ISHR-T500	ISHR-T600
Type	Rockwell	Superficial Rockwell	Rockwell and Superficial Rockwell
Hardness scale	with standard indenters	HR15N, HR30N, HR45N, HR15T, HR30T, HR45T	HRA, HRB, HRC, HRD, HRF, HRG, HR15N, HR30N, HR45N, HR15T, HR30T, HR45T
	with optional indenters	HRE, HRH, HRK, HRL, HRM, HRP, HRR, HRS, HRV	HRE, HRH, HRK, HRL, HRM, HRP, HRR, HRS, HRV, HR15W, HR30W, HR45W, HR15X, HR30X, HR45X, HR15Y, HR30Y, HR45Y
Preliminary test force	Rockwell: 98N (10kg)	Superficial Rockwell: 29.4N (3kg)	Rockwell: 98N (10kg) Superficial Rockwell: 29.4N (3kg)
Total test force	588N (60kg), 980N (100kg), 1471N (150kg)	147.1N (15kg), 294.2N (30kg), 441.3N (45kg)	147.1N (15kg), 294.2N (30kg), 441.3N (45kg), 588N (60kg), 980N (100kg), 1471N (150kg)
Conversion scale	HR, HB, HK, HV		
Stage elevation	manual		
Load control	high speed close-loop system automatic loading (load/dwell/unload)		
Load dwell time	0~99 second		
Resolution	0.1HR		
Data output	built-in printer, RS232		
Max. workpiece height	260mm		
Max. testing width	150mm (from the center of indenter to the wall of main body)		
Power supply	110/220V, 50/60Hz		
Dimension	700×260×700mm		
Weight	85kg		

To be continued

Continued from previous page

STANDARD DELIVERY

Code	ISHR-T400	ISHR-T500	ISHR-T600
Main unit	1 pc	1 pc	1 pc
Ø60mm flat anvil	1 pc	1 pc	1 pc
Ø150mm flat anvil	1 pc	1 pc	1 pc
V-type anvil	1 pc	1 pc	1 pc
Ø1.5875mm carbide ball indenter	1 pc	1 pc	1 pc
Diamond indenter	1 pc	1 pc	1 pc
Hardness test block HRB88~95	1 pc	—	1 pc
Hardness test block HRC20~30	1 pc	—	1 pc
Hardness test block HRC40~50	1 pc	—	1 pc
Hardness test block HRC60~65	1 pc	—	1 pc
Hardness test block 78~88HR15N	—	1 pc	1 pc
Hardness test block 55~73HR30N	—	1 pc	1 pc
Hardness test block 57~69HR30T	—	1 pc	1 pc



Ø60mm flat anvil (included)



Ø150mm flat anvil (included)



V-type anvil (included) for cylinders with diameter Ø4~60mm



small V-type anvil (optional) for cylinders with diameter Ø2~4mm

OPTIONAL ACCESSORY

Hardness test block HRB88~100	HDT-B-HRB
Hardness test block HRC20~30	HDT-B-HRC1
Hardness test block HRC35~55	HDT-B-HRC2
Hardness test block HRC60~70	HDT-B-HRC3
Hardness test block 78~88HR15N	HDT-B-HR15N2
Hardness test block 55~73HR30N	HDT-B-HR30N2
Hardness test block 57~69HR30T	ISH-BHR30T1
Small V-type anvil	ISH-SMALLANVIL
Connection cable and software	ISHR-T-SOFTWARE

AUTOMATIC DIGITAL ROCKWELL/SUPERFICIAL ROCKWELL HARDNESS TESTERS

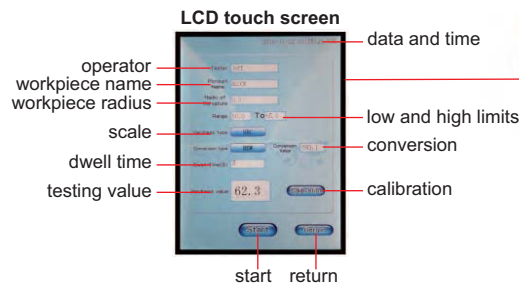
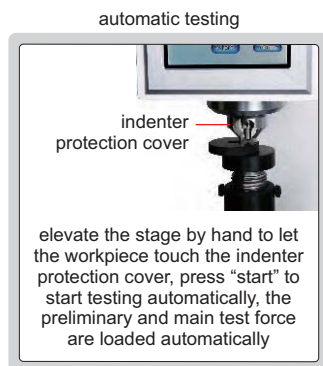
INSPECTION CERTIFICATE



VIDEO

FORCE LOADING BY ELECTRIC MOTOR (WITHOUT WEIGHTS)

DATA OUTPUT



ISH-RSR400

- Automatic testing, the preliminary and main test force are loaded automatically
- LCD touch screen, easy operation
- Convert to other Rockwell scales, HV or HB automatically
- Tolerance testing
- Insert USB flash disk, save the testing results as Excel
- Self-correcting the hardness value for curved workpieces
- Force loading by electric motor (without weights)
- The test force is selected automatically according to hardness scale

To be continued

Continued from previous page



Ø63mm flat anvil
(included)



Ø150mm flat anvil
(included)



level (included)



touch pen (included)



V-type anvil (included)
for cylinders with
diameter Ø4~60mm



small V-type anvil
(optional)
for cylinders with
diameter Ø2~4mm

SPECIFICATION

Code		ISH-RSR400 **	ISH-RSR500 **	ISH-RSR600 **
Type		Rockwell	Superficial Rockwell	Rockwell and Superficial Rockwell
Hardness scale	with standard indenters	HRA, HRB, HRC, HRD, HRF, HRG	HR15N, HR30N, HR45N, HR15T, HR30T, HR45T	HRA, HRB, HRC, HRD, HRF, HRG, HR15N, HR30N, HR45N, HR15T, HR30T, HR45T
	with optional indenter	HRE, HRH, HRK, HRL, HRM, HRP, HRR, HRS, HRV	HR15W, HR30W, HR45W, HR15X, HR30X, HR45X, HR15Y, HR30Y, HR45Y	HRE, HRH, HRK, HRL, HRM, HRP, HRR, HRS, HRV, HR15W, HR30W, HR45W, HR15X, HR30X, HR45X, HR15Y, HR30Y, HR45Y
Preliminary test force		98N/10kgf for Rockwell	29.4N/3kgf for Superficial Rockwell	98N/10kgf for Rockwell 29.4N/3kgf for Superficial Rockwell
Test force		588N (60kg), 980N (100kg), 1471N (150kg)	147.1N (15kg), 294.2N (30kg), 441.3N (45kg)	147.1N (15kg), 294.2N (30kg), 441.3N (45kg), 588N (60kg), 980N (100kg), 1471N (150kg)
Stage elevation		manual		
Load control		automatic (load/dwell/unload)		
Load dwell time		0~60 second		
Resolution		0.1HR		
Output		USB		
Max. workpiece height		220mm		
Max. testing width		200mm (from the center of indenter to the wall of main body)		
Power supply		220V, 50/60Hz **		
Dimension		510×260×780mm		
Weight		70kg		

STANDARD DELIVERY

Code	ISH-RSR400 **	ISH-RSR500 **	ISH-RSR600 **
Main unit	1 pc	1 pc	1 pc
Ø63mm flat anvil	1 pc	1 pc	1 pc
Ø150mm flat anvil	1 pc	1 pc	1 pc
V-type anvil	1 pc	1 pc	1 pc
Diamond indenter	1 pc	1 pc	1 pc
Ø1.5875mm carbide ball indenter	1 pc	1 pc	1 pc
Hardness test block HRB88~95	1 pc	—	1 pc
Hardness test block HRC60~65	1 pc	—	1 pc
Hardness test block HRC20~30	1 pc	—	1 pc
Hardness test block 78~88HR15N	—	1 pc	1 pc
Hardness test block 55~73HR30N	—	1 pc	1 pc
Hardness test block 57~69HR30T	—	1 pc	1 pc
USB flash disk (8G)	1 pc	1 pc	1 pc
Level	1 pc	1 pc	1 pc
Touch pen	1 pc	1 pc	1 pc
Anti-dust cover	1 pc	1 pc	1 pc

** Add "-U" on code No. when power supply is 110V, 50/60Hz

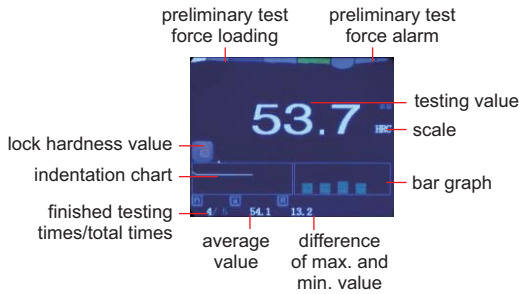
OPTIONAL ACCESSORY

Hardness test block HRB88~100	HDT-B-HRB
Hardness test block HRC60~70	HDT-B-HRC3
Hardness test block HRC20~30	HDT-B-HRC1
Hardness test block 78~88HR15N	HDT-B-HR15N2
Hardness test block 55~73HR30N	HDT-B-HR30N2
Hardness test block 57~69HR30T	ISH-BHR30T1
Small V-type anvil	ISH-SMALLANVIL

AUTOMATIC DIGITAL ROCKWELL HARDNESS TESTER CODE ISH-MRD200**

INSPECTION
CERTIFICATE

DATA
OUTPUT



software CD (included)

- Tolerance testing
- Set testing times (2~10) to have average value and the difference of max. and min. value
- Convert to other Rockwell scales, HV or HB
- Memory of 500 testing values for browsing and output
- Testing value can be sent to wireless printer automatically
- Calibration function compensates the testing value for high accuracy
- The hardness value of soft materials like plastic is not stable, the lock function can obtain the value automatically
- Display unit is automatic power off



Ø60mm flat anvil (included)



Ø150mm flat anvil (included)



V-type anvil (included) for cylinders with diameter Ø4~60mm



small V-type anvil (optional) for cylinders with diameter Ø2~4mm



wireless printer (optional)

SPECIFICATION

Hardness scale	HRA, HRB, HRC, HRD HRF, HRG (with standard indenters) HRE, HRH, HRK (with optional indenter)
Preliminary test force	98N
Test force	588N, 980N, 1471N
Stage elevation	manual
Load control	automatic (load/dwell/unload)
Load dwell time	1~99 second
Resolution	0.1HR
Output	wireless and USB
Memory	500
Max. workpiece height	170mm
Max. testing width	165mm (from the center of indenter to the wall of main body)
Power supply of the display unit	built-in rechargeable battery
Power supply	220V, 50/60Hz **
Dimension	520×160×700mm
Weight	60kg

STANDARD DELIVERY

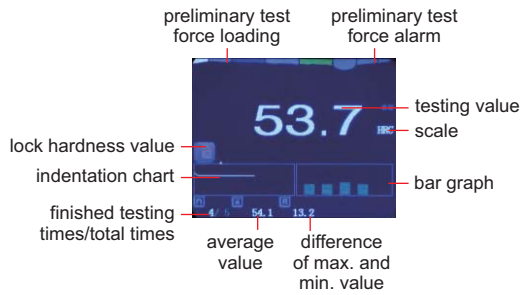
Main unit	1 pc
Ø60mm flat anvil	1 pc
Ø150mm flat anvil	1 pc
V-type anvil	1 pc
Diamond indenter	1 pc
Ø1.5875mm carbide ball indenter	1 pc
Hardness test block HRB88~95	1 pc
Hardness test block HRC60~65	1 pc
Hardness test block HRC20~30	1 pc
Anti-dust cover	1 pc
Software and USB cable	1 pc
AC/DC adapter	1 pc

OPTIONAL ACCESSORY

Wireless printer	ISH-DS-PRINTER
Ø3.175mm carbide ball indenter	ISH-EHK-INDENTER
Hardness test block HRB88~100	HDT-B-HRB
Hardness test block HRC60~70	HDT-B-HRC3
Hardness test block HRC20~30	HDT-B-HRC1
Small V-type anvil	ISH-SMALLANVIL

** Add "-U" on code No. when power supply is 110V, 50/60Hz

MANUAL DIGITAL ROCKWELL HARDNESS TESTER CODE ISH-RD200



- Tolerance testing
- Set testing times (2~10) to have average value and the difference of max. and min. value
- Convert to other Rockwell scales, HV or HB
- Memory of 500 testing values for browsing and output
- Testing value can be sent to wireless printer automatically
- Calibration function compensates the testing value for high accuracy
- The hardness value of soft materials like plastic is not stable, the lock function can obtain the value automatically
- Automatic power off



Ø60mm flat anvil (included)



Ø150mm flat anvil (included)



V-type anvil (included) for cylinders with diameter Ø4~60mm



small V-type anvil (optional) for cylinders with diameter Ø2~4mm



wireless printer (optional)

SPECIFICATION

Hardness scale	HRA, HRB, HRC, HRD HRF, HRG (with standard indenters) HRE, HRH, HRK (with optional indenter)
Preliminary test force	98N
Test force	588N, 980N, 1471N
Stage elevation	manual
Load control	manual
Resolution	0.1HR
Output	wireless and USB
Memory	500
Max. workpiece height	170mm
Max. testing width	165mm (from the center of indenter to the wall of main body)
Power supply	built-in rechargeable battery
Dimension	520×160×700mm
Weight	60kg

STANDARD DELIVERY

Main unit	1 pc
Ø60mm flat anvil	1 pc
Ø150mm flat anvil	1 pc
V-type anvil	1 pc
Diamond indenter	1 pc
Ø1.5875mm carbide ball indenter	1 pc
Hardness test block HRB88~95	1 pc
Hardness test block HRC60~65	1 pc
Hardness test block HRC20~30	1 pc
Anti-dust cover	1 pc
Software and USB cable	1 pc
AC/DC adapter	1 pc

OPTIONAL ACCESSORY

Wireless printer	ISH-DS-PRINTER
Ø3.175mm carbide ball indenter	ISH-EHK-INDENTER
Hardness test block HRB88~100	HDT-B-HRB
Hardness test block HRC60~70	HDT-B-HRC3
Hardness test block HRC20~30	HDT-B-HRC1
Small V-type anvil	ISH-SMALLANVIL

AUTOMATIC ROCKWELL HARDNESS TESTER CODE ISH-MR150**



OPTIONAL ACCESSORY

Hardness test block HRB88~100	HDT-B-HRB
Hardness test block HRC60~70	HDT-B-HRC3
Hardness test block HRC20~30	HDT-B-HRC1
Small V-type anvil	ISH-SMALLANVIL

SPECIFICATION

Hardness scale	HRA, HRB, HRC, HRD, HRF, HRG
Preliminary test force	98N
Test force	588N, 980N, 1471N
Display	analogue
Stage elevation	manual
Load control	automatic (load/dwell/unload)
Load dwell time	1~99 second
Min. reading	0.5HR
Max. workpiece height	170mm
Max. testing width	165mm (from the center of indenter to the wall of main body)
Power supply	220V, 50/60Hz**
Dimension	520×160×700mm
Weight	60kg

** Add "-U" on code No. when power supply is 110V, 50/60Hz

STANDARD DELIVERY

Main unit	1 pc
Ø60mm flat anvil	1 pc
Ø150mm flat anvil	1 pc
V-type anvil	1 pc
Diamond indenter	1 pc
Ø1.5875mm carbide ball indenter	1 pc
Hardness test block HRB88~95	1 pc
Hardness test block HRC60~65	1 pc
Hardness test block HRC20~30	1 pc
Anti-dust cover	1 pc

AUTOMATIC ROCKWELL HARDNESS TESTER (BASIC TYPE) CODE HDT-RA151**



OPTIONAL ACCESSORY

Hardness test block HRA80~84	HDT-B-HRA
Hardness test block HRB88~100	HDT-B-HRB
Hardness test block HRC20~30	HDT-B-HRC1
Hardness test block HRC35~55	HDT-B-HRC2
Hardness test block HRC60~70	HDT-B-HRC3
Small V-type anvil	ISH-SMALLANVIL

SPECIFICATION

Hardness scale	HRA, HRB, HRC, HRD, HRF, HRG
Preliminary test force	98N
Test force	588N, 980N, 1471N
Display	analogue
Stage elevation	manual
Load control	automatic (load/dwell/unload)
Load dwell time	1~60 second
Min. reading	0.5HR
Max. workpiece height	170mm
Max. testing width	128mm (from the center of indenter to the wall of main body)
Power supply	220V, 50/60Hz**
Dimension	520×225×640mm
Weight	65kg

** Add "-U" on code No. when power supply is 110V, 50/60Hz

STANDARD DELIVERY

Main unit	1 pc
Ø58mm flat anvil	1 pc
Ø150mm flat anvil	1 pc
V-type anvil	1 pc
Diamond indenter	1 pc
Ø1.5875mm steel ball indenter	1 pc
Level	1 pc
Hardness test block HRA80~88	1 pc
Hardness test block HRB85~95	1 pc
Hardness test block HRC20~30	1 pc
Hardness test block HRC35~55	1 pc
Hardness test block HRC60~70	1 pc
Anti-dust cover	1 pc



MANUAL ROCKWELL HARDNESS TESTER CODE ISH-R150

SPECIFICATION

Hardness scale	HRA, HRB, HRC, HRD, HRF, HRG
Preliminary test force	98N
Test force	588N, 980N, 1471N
Display	analogue
Stage elevation	manual
Load control	manual
Min. reading	0.5HR
Max. workpiece height	170mm
Max. testing width	165mm (from the center of indenter to the wall of main body)
Dimension	520×160×700mm
Weight	60kg

STANDARD DELIVERY

Main unit	1 pc
Ø60mm flat anvil	1 pc
Ø150mm flat anvil	1 pc
V-type anvil	1 pc
Diamond indenter	1 pc
Ø1.5875mm carbide ball indenter	1 pc
Hardness test block HRB88~95	1 pc
Hardness test block HRC60~65	1 pc
Hardness test block HRC20~30	1 pc
Anti-dust cover	1 pc



V-type anvil (included) for cylinders with diameter Ø4~60mm



small V-type anvil (optional) for cylinders with diameter Ø2~4mm

OPTIONAL ACCESSORY

Hardness test block HRB88~100	HDT-B-HRB
Hardness test block HRC60~70	HDT-B-HRC3
Hardness test block HRC20~30	HDT-B-HRC1
Small V-type anvil	ISH-SMALLANVIL



MANUAL ROCKWELL HARDNESS TESTER (BASIC TYPE) CODE HDT-RW160

SPECIFICATION

Hardness scale	HRA, HRB, HRC, HRD, HRF, HRG
Preliminary test force	98N (10kg)
Test force	588N (60kg), 980N (100kg), 1471N (150kg)
Display	analogue
Stage elevation	manual
Load control	manual
Min. reading	0.5HR
Max. workpiece height	170mm
Max. testing width	135mm (from the center of indenter to the wall of main body)
Dimension	466×238×630mm
Weight	70kg

STANDARD DELIVERY

Main unit	1 pc
Ø58mm flat anvil	1 pc
Ø150mm flat anvil	1 pc
V-type anvil	1 pc
Diamond indenter	1 pc
Ø1.5875mm steel ball indenter	1 pc
Ø1.5875mm steel ball	5 pcs
Level	1 pc
Hardness test block HRA80~88	1 pc
Hardness test block HRB85~95	1 pc
Hardness test block HRC20~30	1 pc
Hardness test block HRC35~55	1 pc
Hardness test block HRC60~70	1 pc
Anti-dust cover	1 pc



V-type anvil (included) for cylinders with diameter Ø4~60mm



level (included)



small V-type anvil (optional) for cylinders with diameter Ø2~4mm

OPTIONAL ACCESSORY

Hardness test block HRA80~84	HDT-B-HRA
Hardness test block HRB88~100	HDT-B-HRB
Hardness test block HRC20~30	HDT-B-HRC1
Hardness test block HRC35~55	HDT-B-HRC2
Hardness test block HRC60~70	HDT-B-HRC3
Small V-type anvil	ISH-SMALLANVIL

MANUAL ROCKWELL AND SUPERFICIAL ROCKWELL HARDNESS TESTER CODE HDT-RSR100



INSPECTION CERTIFICATE



Ø60mm flat anvil
(included)



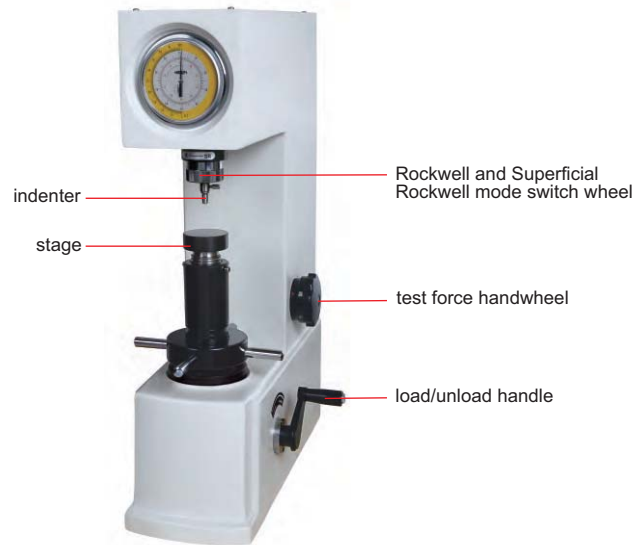
Ø150mm flat anvil
(included)



V-type anvil
(included) for
cylinders with
diameter Ø4~60mm



small V-type anvil
(optional) for
cylinders with
diameter Ø2~4mm



SPECIFICATION

Hardness scale	HRA, HRB, HRC, HRD, HRF, HRG, HR15N, HR30N, HR45N, HR15T, HR30T, HR45T
Preliminary test force	29.4N/3kgf for Superficial Rockwell 98N/10kgf for Rockwell
Test force	147N/15kgf, 294N/30kgf, 441N/45kgf, 588N/60kgf, 980N/100kgf, 1471N/150kgf
Display	analogue
Stage elevation	manual
Load control	manual
Min. reading	0.5HR
Max. workpiece height	160mm
Max. testing width	140mm (from the center of indenter to the wall of main body)
Dimension	460×240×660mm
Weight	75kg

STANDARD DELIVERY

Main unit	1 pc
Ø60mm flat anvil	1 pc
Ø150mm flat anvil	1 pc
V-type anvil	1 pc
Diamond indenter	1 pc
Ø1.5875mm carbide ball indenter	1 pc
Hardness test block HRB88~95	1 pc
Hardness test block HRC60~65	1 pc
Hardness test block HRC20~30	1 pc
Hardness test block 78~88HR15N	1 pc
Hardness test block 55~73HR30N	1 pc
Hardness test block 57~69HR30T	1 pc
Anti-dust cover	1 pc

OPTIONAL ACCESSORY

Hardness test block HRB88~100	HDT-B-HRB
Hardness test block HRC60~70	HDT-B-HRC3
Hardness test block HRC20~30	HDT-B-HRC1
Hardness test block 78~88HR15N	HDT-B-HR15N2
Hardness test block 55~73HR30N	HDT-B-HR30N2
Hardness test block 57~69HR30T	ISH-BHR30T1
Small V-type anvil	ISH-SMALLANVIL



Ø60mm flat anvil for Rockwell (included)



Ø150mm flat anvil for Rockwell (included)



Ø60mm flat anvil for Vickers and Brinell (included)



V-type anvil for Rockwell (included), for cylinders with diameter Ø4~60mm



V-type anvil for Vickers and Brinell (included)



small V-type anvil for Rockwell (optional), for cylinders with diameter Ø2~4mm



SPECIFICATION

Rockwell test load	98N preload, 588, 980, 1471N total load
Min. Rockwell reading	0.5HR
Brinell test load	306, 613, 1839N
Vickers test load	294N
Stage elevation	manual
Load control	manual
Magnification of microscope	37.5X/75X
Max. workpiece height	180mm
Max. testing width	200mm (from the center of indenter to the wall of main body)
Power supply	220V, 50/60Hz **
Dimension	546×300×767mm
Weight	90kg

** Add "-U" on code No. when power supply is 110V, 50/60Hz

STANDARD DELIVERY

Main unit	1 pc
Ø1.5875mm carbide ball indenter	1 pc
Diamond Rockwell indenter	1 pc
Ø5mm Brinell indenter	1 pc
Ø2.5mm Brinell indenter	1 pc
Vickers indenter	1 pc
Ø60mm flat anvil for Rockwell	1 pc
Ø150mm flat anvil for Rockwell	1 pc
V-type anvil for Rockwell	1 pc
Ø60mm flat anvil for Vickers and Brinell	1 pc
V-type anvil for Vickers and Brinell	1 pc
Hardness test block HRB88~95	1 pc
Hardness test block HRC60~65	1 pc
Hardness test block HRC20~30	1 pc
Hardness test block 400~500HV30	1 pc
Hardness test block 180~300HBW2.5/187.5	1 pc
Anti-dust cover	1 pc

OPTIONAL ACCESSORY

Hardness test block HRB88~100	HDT-B-HRB
Hardness test block HRC60~70	HDT-B-HRC3
Hardness test block HRC20~30	HDT-B-HRC1
Hardness test block 400-500HV30	HDT-B-HV30D
Hardness test block 200-3000HBW2.5/187.5	HDT-B-HB25A2
Small V-type anvil for Rockwell	ISH-SMALLANVIL

AUTOMATIC DIGITAL BRINELL HARDNESS TESTERS

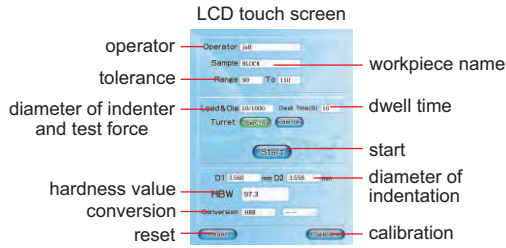
AUTOMATIC TESTING,
AUTOMATIC TEST FORCE LOADING



VIDEO

FORCE LOADING BY ELECTRIC
MOTOR (WITHOUT WEIGHT)

INSPECTION
CERTIFICATE



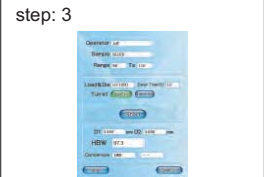
ISHB-D200



step 1
elevate the stage by hand to let the indenter approach the workpiece, press "start" to start testing automatically, the test force is loaded automatically



step 2
measure indentation with measuring microscope



step 3
read the hardness value from LCD

- Automatic testing, automatic test force loading
- LCD touch screen, easy operation
- Measure indentation by measuring microscope then read the hardness value from LCD
- Tolerance testing
- Insert USB flash disk, save the test results as Excel
- Converted to HRA, HRB, HRC, HRD, HRF, HV, HB, HR15N, HR30N, HR45N, HR15T, HR30T, HR45T
- Force loading by electric motor, without weights



Ø80mm flat anvil (included)



Ø200mm flat anvil (included)



V-type anvil (included)



touch pen (included)

SPECIFICATION

Code	ISHB-D200 **	ISHB-D300 **
Turret rotation	manual	automatic
Range	8~650HBW	
Reading mode	directly read from LCD	
Test force	62.5, 100, 125, 187.5, 250, 500, 750, 1000, 1500, 3000kgf	
Max. workpiece height	200mm	
Max. testing width	155mm (from the center of indenter to the wall of main body)	
Stage elevation	manual	
Load control	automatic (load/dwell/unload)	
Load dwell time	5~60 second	
Measuring microscope	magnification	20X
	resolution	0.625mm
Power supply	220V, 50/60Hz **	
Dimension	550x210x750mm	
Weight	110kg	

** Add "-U" on code No. when power supply is 110V, 50/60Hz

STANDARD DELIVERY

Main unit	1 pc
Ø80mm flat anvil	1 pc
Ø200mm flat anvil	1 pc
V-type anvil	1 pc
Ø2.5mm carbide ball indenter	1 pc
Ø5mm carbide ball indenter	1 pc
USB flash disk (8G)	1 pc
Ø10mm carbide ball indenter	1 pc
Hardness test block 150~250HBW2.5/187.5	1 pc
Hardness test block 75~125HBW10/1000	1 pc
Hardness test block 175~250HBW10/3000	1 pc
Touch pen	1 pc
Anti-dust cover	1 pc

OPTIONAL ACCESSORY

Hardness test block 200~300HBW2.5/187.5	HDT-B-HB25A2
Hardness test block 90~200HBW10/1000	HDT-B-HB10C1
Hardness test block 200~300HBW10/3000	HDT-B-HB10A2
Brinell indentation measuring system	ISHB-MSA

FORCE LOADING BY ELECTRIC MOTOR (WITHOUT WEIGHTS)


AUTOMATIC TESTING AFTER PRELIMINARY TEST FORCE IS LOADED BY HAND

AUTOMATIC BRINELL HARDNESS TESTER CODE ISHB-M100**




**INSPECTION
CERTIFICATE**

step: 1

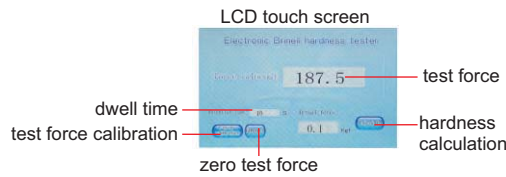


measure indentation diameter by measuring microscope

step: 2



input the diameters, the hardness value is shown on screen automatically



- LCD touch screen, easy operation
- Automatic testing after preliminary test force is loaded by hand
- Measure indentation diameter by measuring microscope, input the diameters, the hardness value is shown on screen automatically
- Force loading by electric motor, without weights



SPECIFICATION

Range	8~650HBW	
Reading mode	directly read from LCD	
Test force	62.5, 100, 125, 187.5, 250, 500, 750, 1000, 1500, 3000kgf	
Max. workpiece height	230mm	
Max. testing width	160mm (from the center of indenter to the wall of main body)	
Stage elevation	manual	
Load control	automatic (load/dwell/unload)	
Load dwell time	5~60 second	
Measuring microscope	magnification	20X
	graduation	0.01mm
Power supply	220V, 50/60Hz **	
Dimension	550×210×750mm	
Weight	90kg	

** Add "-U" on code No. when power supply is 110V, 50/60Hz

STANDARD DELIVERY

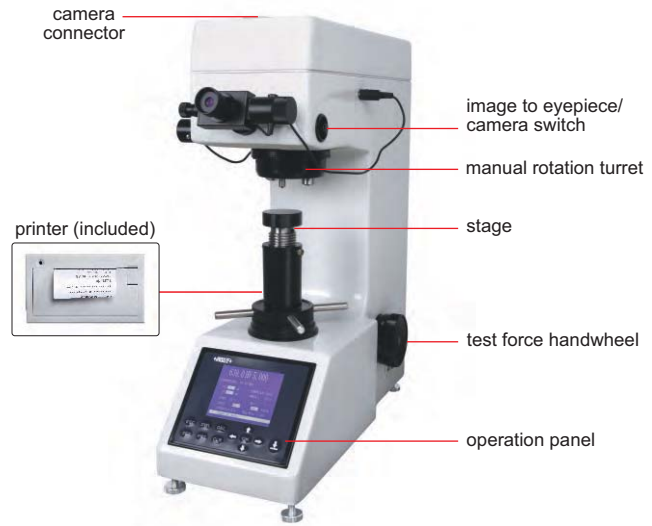
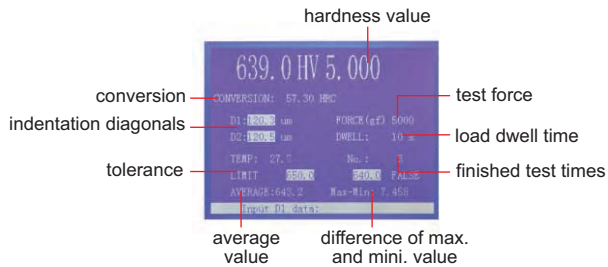
Main unit	1 pc
Ø80mm flat anvil	1 pc
Ø200mm flat anvil	1 pc
V-type anvil	1 pc
Ø2.5mm carbide ball indenter	1 pc
Ø5mm carbide ball indenter	1 pc
Ø10mm carbide ball indenter	1 pc
Hardness test block 150~250HBW2.5/187.5	1 pc
Hardness test block 75~125HBW10/1000	1 pc
Hardness test block 175~250HBW10/3000	1 pc
Measuring microscope	1 pc
Anti-dust cover	1 pc

OPTIONAL ACCESSORY

Hardness test block 200~300HBW2.5/187.5	HDT-B-HB25A2
Hardness test block 90~200HBW10/1000	HDT-B-HB10C1
Hardness test block 200~300HBW10/3000	HDT-B-HB10A2
Brinell indentation measuring system	ISHB-MSA

DIGITAL VICKERS HARDNESS TESTERS

**INSPECTION
CERTIFICATE**



ISH-DV5

- Based on Vickers (HV), can be converted to HRA, HRB, HRC, HRD, HR15N, HR30N, HR45N, HR15T, HR30T, HR45T, HK, HBW
- Can take tests up to 99 times, display average value and the difference of max. and mini. value
- Tolerance testing
- Also for Knoop hardness test, Knoop indenter is needed (optional)

SPECIFICATION

Code	ISH-DV5 **	ISH-DV10 **	ISH-DV50 **
Measuring range	5HV0.2~2500HV5	8HV0.3~2500HV10	5HV1~2500HV50
Test force	0.2, 0.5, 1, 2, 3, 5kgf	0.3, 0.5, 1, 3, 5, 10kgf	1, 5, 10, 20, 30, 50kgf
Accuracy	±3%	±3%	±3% (test force 1, 5, 10, 20kgf) ±2% (test force 30, 50kgf)
Eyepiece	magnification	10X	
	resolution	0.0625µm	
Objective	10X, 20X		
Total magnification	100X (for observation) 200X (for measuring)		
Stage elevation	manual		
Load control	automatic (load/dwell/unload)		
Dwell time	5~60 second		
Max. workpiece height	160mm		
Max. testing width	135mm (from the center of indenter to the wall of main body)		
Data output	RS232C		
Power supply	220V, 50/60Hz **		
Dimension	540×270×650mm		
Weight	33kg	35kg	45kg



Ø60mm flat anvil (included)



Ø150mm flat anvil (included)



V-type anvil (included)

** Add "-U" on code No. when power supply is 110V, 50/60Hz

23

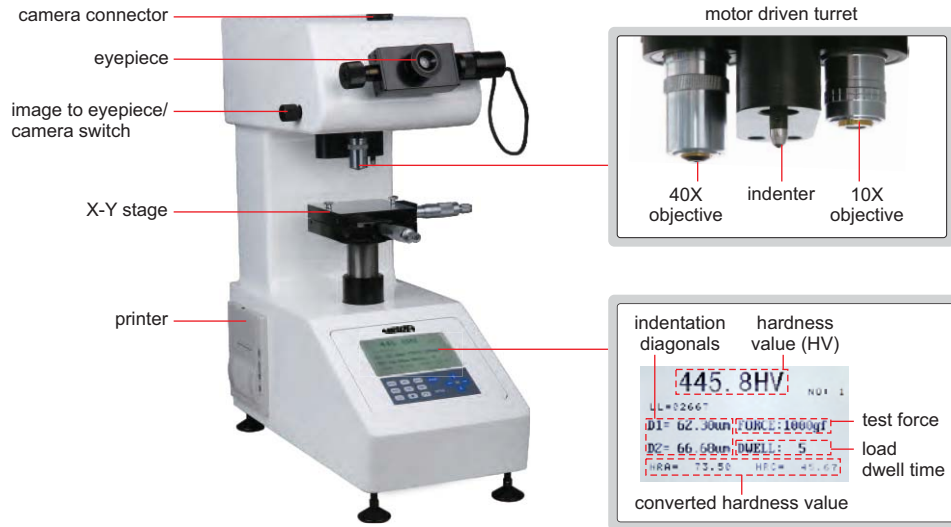
STANDARD DELIVERY

Main unit	1 pc
Ø60mm flat anvil	1 pc
Ø150mm flat anvil	1 pc
V-type anvil	1 pc
Vickers indenter	1 pc
10X objective	1 pc
20X objective	1 pc
Vickers test block	2 pcs
Anti-dust cover	1 pc

OPTIONAL ACCESSORY

Knoop indenter	ISH-KNOOP
Hardness test block 400~500HV5	HDT-B-HV5D
Hardness test block 700~750HV5	HDT-B-HV5G
Hardness test block 400~500HV10	HDT-B-HV10D
Hardness test block 700~750HV10	HDT-B-HV10G
Hardness test block 400~500HV30	HDT-B-HV30D
Camera adapter	ISH-DV-ADAPTER
Measuring system	9631-130

DIGITAL MICRO-VICKERS HARDNESS TESTER CODE ISH-TDV1000A **



- Measure hardness of thin or small workpieces
- Based on Vickers (HV), can be converted to Rockwell (HRA, HRB and HRC)



cylinder holder (included)



vice (included)



slice holder (included)

SPECIFICATION

Test force	0.01, 0.025, 0.05, 0.1, 0.2, 0.3, 0.5, 1kgf
Vickers scales	HV0.01, HV0.025, HV0.05, HV0.1, HV0.2, HV0.3, HV0.5, HV1
Stage elevation	manual
Load control	automatic (load/dwell/unload)
Load dwell time	5~60 second (5 second increment)
Objective	10X, 40X
Eyepiece	15X
Total magnification	150X (for observation) 600X (for measurement)
Max. workpiece height	85mm
Max. testing width	85mm (from the center of indenter to the wall of main body)
X-Y stage	dimensions: 100×100mm
	travel range: 25×25mm
	graduation: 0.01mm
Data output	RS232C
Power supply	110/220V, 50Hz **
Dimension	540x500x640mm
Weight	50kg

STANDARD DELIVERY

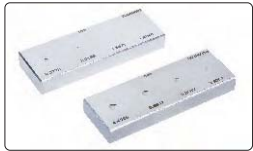
Main unit	1 pc
10X, 40X objective	1 pc of each
Micro Vickers indenter	1 pc
Hardness test block 400~500HV0.2	1 pc
Hardness test block 700~800HV1	1 pc
Slice holder	1 pc
Vice	1 pc
Cylinder holder	1 pc
Level	1 pc
Anti-dust cover	1 pc

OPTIONAL ACCESSORY

20X objective	ISH-TDV-20X
Hardness test block 400~500HV0.2	HDT-B-HV02C
Hardness test block 700~750HV1	HDT-B-HV1F
Measuring system	9631-130
Camera adapter	ISH-TDV-ADAPTER

** Add "-B" on code No. when power supply is 110/220V, 60Hz

BRINELL INDENTATION MEASURING SYSTEM CODE ISHB-MSA



standard blocks for Ø5mm and Ø10mm indenters (included)



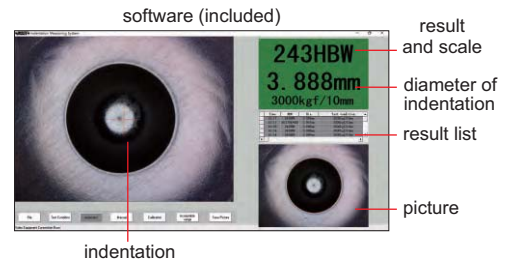
VIDEO



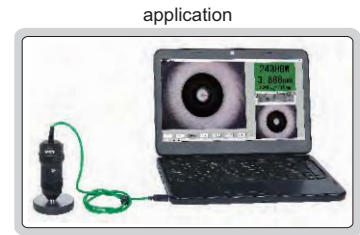
- Connected to computer USB port
- Automatically measure the indentation
- Result saved to Excel automatically
- Tolerance testing
- Calibration with standard hardness blocks or standard indentation blocks

SPECIFICATION

Applicable Brinell indenter	Ø10mm, Ø7.26mm, Ø5mm, Ø4mm, Ø2.5mm	
Hardness range	16~650HB	
Range of indentation diameter	Ø0.6~6mm	
Test force	62.5, 100, 125, 187.5, 250, 500, 750, 1000, 1500, 3000kgf	
Hardness resolution	1HB	
Diameter measuring resolution	0.001mm	
Diameter measuring accuracy	Ø10mm ball indneter	±0.4% (indentation diameter)
	Ø5mm ball indneter	±0.8% (indentation diameter)
	Ø2.5mm ball indneter	±1.2% (indentation diameter)
Camera	sensor	1/3.2" CMOS
	pixel	2M (resolution 1600×1200)
	view filed	8×6mm
Dimension	170×54×54mm	
Weight	385g	



software CD (included)



STANDARD DELIVERY

Main unit	1 pc
Software	1 pc
Ø5mm standard indentation block	1 pc
Ø10mm standard indentation block	1 pc

OPTIONAL ACCESSORY

Ø2.5mm standard indentation block	ISHB-MSA-BLOCK25
-----------------------------------	------------------

VICKERS HARDNESS MEASURING SYSTEM CODE 9631-130

- Connected to computer USB port
- Measure the indentation sizes automatically or manually
- Multiple measurements to have average value, max. value and min. value
- Tolerance testing
- Convert to HRA, HRB, HRC, HRD, HRE, HRF, HRG, HRK, HR15T/30T/45T, HR15N/30N/45N, HK, HV, HB, HS, HSD
- Calibration with standard test block
- Measurement result can be sent to Word or Excel



application example



VIDEO



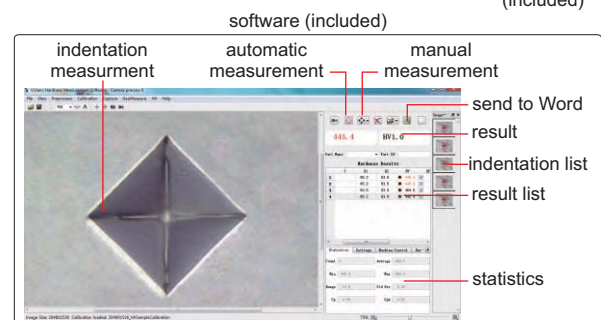
software CD (included)

SPECIFICATION

Sensor	1/2" CMOS
Pixel	1.3M (resolution 1280×1024)
Hardness measurement resolution	0.1HV
Length measurement resolution	0.1µm
Hardness measurement accuracy	±3%
Test force	0.01, 0.025, 0.05, 0.1, 0.2, 0.3, 0.5, 1, 2, 2.5, 3, 5, 10, 20, 30, 50, 100kgf
Dimension	57×51×49mm
Weight	200g

STANDARD DELIVERY

Main unit	1 pc
USB dongle	1 pc
Software and USB cable	1 pc



ATTENTION: HARDNESS BLOCKS FOR CALIBRATION ARE OPTIONAL

ATTENTION: NEED TO CONFIRM IF THE WORKPIECES ARE SUITABLE BEFORE PURCHASE

ULTRASONIC HARDNESS TESTER CODE ISHU-330

INSPECTION
CERTIFICATE

DATA
OUTPUT



Application:

1. For steel material
2. Test surface hardening layers (carburized, nitriding, high frequency hardened, etc.)
3. Suitable for arc and conical surface
4. Suitable for small or light workpieces
5. Test large workpieces at any direction
6. Suitable for rough surfaces



test flat surfaces
(with the cover)



test cylinder surfaces
(use V-groove
on the cover)



- Small test indentation
- Test force and time are not affected by the operator
- Quick testing, only 2 seconds
- Average and statistics test modes
- Memory of 1024 test results for browsing and output
- Automatic power off
- Anti-dust and waterproof

SPECIFICATION OF MAIN UNIT

Hardness scale	HV, HB, HRC, MPa	
Range	100~940HV, 80~650HB, 20~70HRC, 370~1740MPa	
Resolution	1HV, 1HB, 0.1HRC, 1MPa	
Accuracy	HB	±3%
	HV	±3%
	HRC	±1.5%
Data output	USB	
Operating temperature	-20°C ~ +40°C	
Power supply	built-in rechargeable battery	
Dimension of main unit	120×60×25mm	
Weight of main unit	200g	

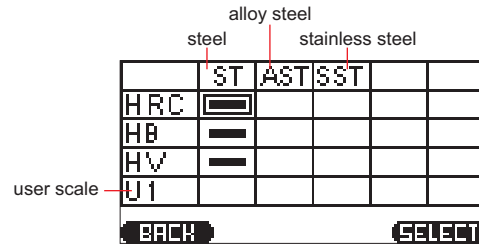
STANDARD DELIVERY

Main unit	1 pc
Probe A	1 pc
Rechargeable battery	2 pcs
Charger	1 pc
Software and USB cable	1 pc

SPECIFICATION OF PROBE

Type	A (standard)	B (optional)
Test force	50N	10N (small force)
Application	general use	plating
Maximum roughness of workpieces (Ra)	2.5µm	1.5µm
Minimum weight of workpieces (direct measurement)	0.1kg *	0.1kg *
Minimum thickness of workpieces (direct measurement)	1mm *	1mm *
Minimum radius of workpieces	5mm	5mm
Minimum thickness of surface hardening layer or plating	0.1mm	0.03mm
Minimum test area	Ø1mm	Ø1mm
Dimension and weight of probe	140×Ø37mm, 271g	145×Ø37mm, 271g

* If the weight or thickness of workpieces is less than required, the workpieces should be fixed or coupled on solid support.



select the material and scale, use the corresponding standard hardness blocks or workpieces for calibration (calibration of HRC, HB and HV for steel are already made, calibration is needed before use other materials and scales)

OPTIONAL ACCESSORY

Probe B	ISHU-460-B
Couplant	ISH-COULPLANT
Hardness block HRC20~30	HDT-B-HRC1
Hardness block HRC35~55	HDT-B-HRC2
Hardness block HRC60~70	HDT-B-HRC3
Hardness block 200~300HV5	HDT-B-HV5B
Hardness block 400~500HV5	HDT-B-HV5D
Hardness block 700~750HV5	HDT-B-HV5G
Hardness block 90~200HBW10/1000	HDT-B-HB10C1
Hardness block 200~300HBW10/3000	HDT-B-HB10A2
Hardness block 400~500HBW10/3000	HDT-B-HB10A4

PORTABLE LEEB HARDNESS TESTER APPLICABLE MATERIAL AND HARDNESS RANGE OF IMPACT DEVICE D

Material	HLD	HV	HB	HRC	HRB	HS	Tensile strength (MPa)
Steel & cast steel	300-900	81-955	81-654	20-68	38-100	32-100	375-2639
Tool steel	300-840	80-898		20-67			
Stainless steel	300-800	85-802	85-655		46-101		
Cast iron	360-650		93-334				
Cast aluminum alloy	170-570		19-164		23-84		
Brass	200-550		40-173		13-95		
Bronze	300-700		60-290				
Copper	200-690		45-315				

PORTABLE LEEB HARDNESS TESTER CODE ISH-PHB



- Based on Leeb (HLD), converted to Vickers (HV), Brinell (HB), Rockwell (HRC and HRB), Shore (HS) and tensile strength (MPa)
- Memory of 99 measurement values for browsing
- Set measurement times (1~9) to have average value
- Connected with printer via bluetooth
- Automatic power off, according to ASTM A 956



hardness test block D (included)



small support ring (included)



wireless printer (optional)

SPECIFICATION

Min. reading	1HLD, 1HV, 1HB, 0.1HRC, 0.1HRB, 1HS, 1MPa	
Accuracy	±6HLD (when HLD=800)	
Display	Leeb (HLD), converted hardness, material, impact direction, test times, average value, date	
Output	bluetooth	
Applicable workpiece	minimum weight	5kg 2kg (on solid support) 0.1kg (coupled on plate)
	minimum thickness	5mm
	minimum radius of curved surface	30mm
	maximum roughness (Ra)	1.6µm
Power supply	3×AAA batteries	
Dimension	150×84×28mm	
Weight	200g	

STANDARD DELIVERY

Main unit	1 pc
Impact device D	1 pc
Hardness test block D	1 pc
Small support ring	1 pc
Cleaning brush	1 pc

OPTIONAL ACCESSORY

Wireless printer	ISH-DS-PRINTER
Couplant	ISH-COUPPLANT
Support rings	see details
Hardness test block D	HDT-B-HLD3

PORTABLE LEEB HARDNESS TESTER CODE ISH-SPHA

- Based on Leeb (HL), converted to Vickers (HV), Brinell (HB), Rockwell (HRC and HRB), Shore (HS) and tensile strength (MPa)
- Connected with printer via bluetooth
- Connected with computer via USB port
- Up to 800 test results can be saved
- Tolerance testing
- Touch screen operation, large display with backlight
- Language: English, Chinese, Italian, German, French and Portuguese
- Automatic power off
- According to ASTM A 956



software CD
(included)



hardness test
block D (included)



small support ring
(included)



printer (included)

SPECIFICATION

Min. reading	1HL, 1HV, 1HB, 0.1HRC, 0.1HRB, 1HS, 1MPa
Accuracy	±6HL (when HL=800)
Display	Leeb (HL), converted hardness, material, impact direction, test times, average value, deviation, time
Output	bluetooth and USB
Power supply	built-in rechargeable battery
Dimension	135×83×24mm
Weight	350g

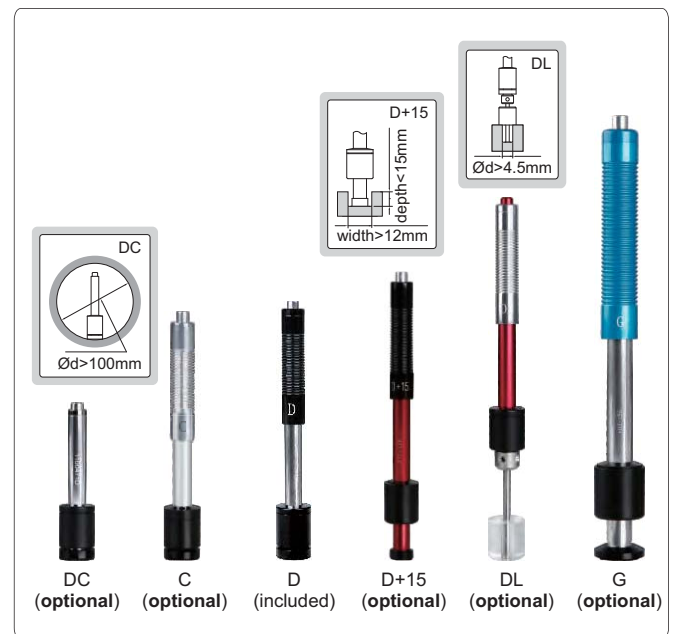
STANDARD DELIVERY

Main unit	1 pc
Impact device D	1 pc
Printer	1 pc
Hardness test block D	1 pc
Small support ring	1 pc
Cleaning brush	1 pc
AC/DC adapter	1 pc
Software disc and USB cable	1 pc
Pen for touch screen	1 pc

OPTIONAL ACCESSORY

Impact device DC	ISH-SPHA-DC
Impact device C	ISH-SPHA-C
Impact device D+15	ISH-SPHA-D15
Impact device DL	ISH-SPHA-DL
Impact device G	ISH-SPHA-G
Hardness test block D*	HDT-B-HLD3
Hardness test block G*	HDT-B-HLG2
Couplant	ISH-COUPPLANT
Support rings	see details

* Hardness test block G (HDT-B-HLG2) is for impact device G (ISH-SPHA-G).
Hardness test block D (HDT-B-HLD3) is for all others impact devices.



APPLICABLE WORKPIECE

Impact device	DC	C	D	D+15	DL	G
Application	inner wall of small space	small or thin workpiece, coating layer	general use	deep groove	narrow slot or small hole	casting or forging workpiece
Maximum roughness of workpiece (Ra)	1.6µm	0.4µm	1.6µm	1.6µm	1.6µm	7µm
Minimum weight of workpiece	direct measurement	5kg	1.5kg	5kg	5kg	15kg
	on solid support	2kg	0.5kg	2kg	2kg	5kg
	coupled on plate	0.1kg	0.02kg	0.1kg	0.1kg	0.5kg
Minimum thickness of workpiece	5mm	1mm	5mm	5mm	5mm	10mm

PORTABLE LEEB HARDNESS TESTERS (BASIC TYPE)



- Can change probes
- Dual-coil probe for high accuracy
- Universal testing angle, no need to set impact direction
- Based on Leeb (HLD), converted to Vickers (HV), Brinell (HB), Rockwell (HRC, HRA and HRB), Shore (HS) and tensile strength (SGM)
- Dual value display, shows both Leeb and converted hardness
- Large LCD display with backlight
- Can choose large font display and statistics display
- Automatically calculate maximum, minimum and average value
- Save 300 data
- Operating temperature: -10°C~45°C
- According to ASTM A956, DIN 50156, GB/T 17394

SPECIFICATION

Code	HDT-LP200	HDT-LP200B
Printer	not included	included
Output	—	bluetooth
Resolution	1HLD/1HV/1HB/0.1HRC/0.1HRB/ 0.1HRA/0.1HS/1SGM	
Accuracy	±6HLD (when HLD=800)	
Measuring range	HL 100-960/HRC 0.9-79.2/HRB 1-140/ HB 1-1878/HV 1-1698/HS 0.5-1370/ HRA 1-88.5/SGM (rm) 1-6599N/mm ²	
Power supply	2xAAA battery	
Dimension	127×67×30mm	
Weight	240g	

STANDARD DELIVERY

Main unit	1 pc
Hardness test block D	1 pc
Small support ring	1 pc
Cleaning brush	1 pc
Impact device D	1 pc
Printer (included in HDT-LP200B)	1 pc

OPTIONAL ACCESSORY

Impact device DC	HDT-LP200-DC
Impact device C	HDT-LP200-C
Impact device D+15	HDT-LP200-D15
Impact device DL	HDT-LP200-DL
Impact device E	HDT-LP200-E
Impact device G	HDT-LP200-G
Hardness test block D*	HDT-B-HLD3
Hardness test block G*	HDT-B-HLG2
Support rings	see details

* Hardness test block G (HDT-B-HLG2) is for impact device G (HDT-LP200-G).
Hardness test block D (HDT-B-HLD3) is for all others impact devices.



HDT-LP200



hardness test block D (included)



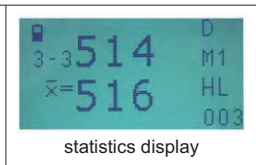
small support ring (included)



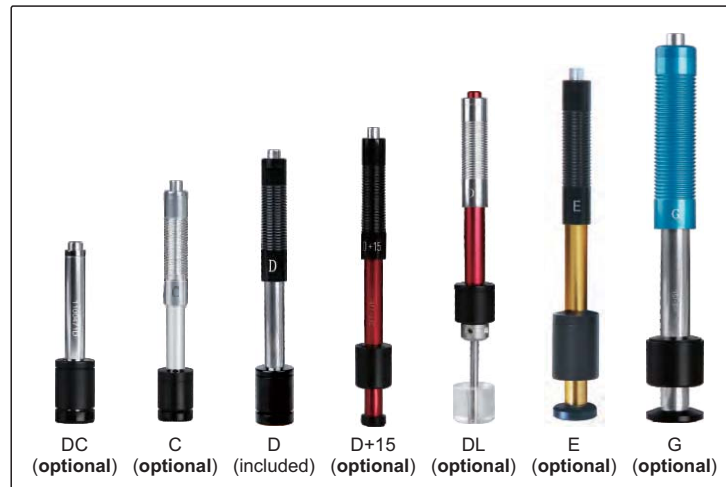
wireless printer (included in HDT-LP200B)



large font display



statistics display



DC (optional) C (optional) D (included) D+15 (optional) DL (optional) E (optional) G (optional)

APPLICABLE WORKPIECE

Impact device	DC	C	D	D+15	DL	E	G
Application	inner wall of small space	small or thin workpiece, coating layer	general use	deep groove	narrow slot or small hole	very hard material	casting or forging workpiece
Maximum roughness of workpiece (Ra)	2µm	0.4µm	2µm	2µm	2µm	2µm	7µm
Minimum weight of workpiece	direct measurement	5kg	1.5kg	5kg	5kg	5kg	15kg
	on solid support	2kg	0.5kg	2kg	2kg	2kg	5kg
	coupled on plate	0.05kg	0.02kg	0.05kg	0.1kg	0.05kg	0.5kg
Minimum thickness of workpiece	3mm	1mm	3mm	3mm	3mm	3mm	10mm

DATA OUTPUT

HIGH ACCURACY

DL PROBE IS OPTIONAL

PORTABLE LEEB HARDNESS TESTER (HIGH ACCURACY) CODE HDT-L410

INSPECTION CERTIFICATE



software CD (included)



hardness test block D (included)



wireless printer (optional)



small support ring (included)

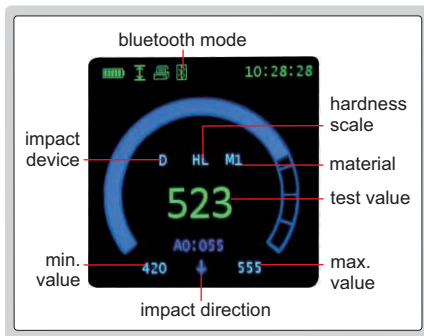
DL probe can be installed (optional)



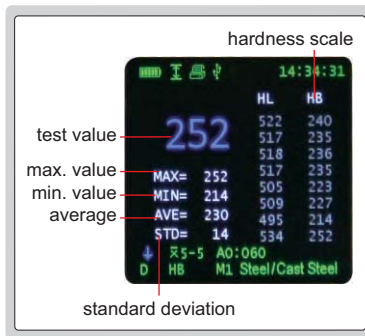
- Metal housing
- HD TFT 320×320 display
- Impact device D
- Based on Leeb (HLD), converted to Vickers (HV), Brinell (HB), Rockwell (HRC, HRA and HRB), Shore (HS) and tensile strength (SGM)
- Four display modes
- Automatic direction correction
- Tolerance testing
- Automatic power off, automatic calculation of statistics
- Dual value display, shows both Leeb and other conversion values
- 31 files can be saved, each containing 100 measurement data
- Connected to PC software via USB or Bluetooth 2.0
- Connected with printer via Bluetooth
- Operating temperature: -20°C~70°C
- According to ASTM A956, DIN 50156, GB/T 17394



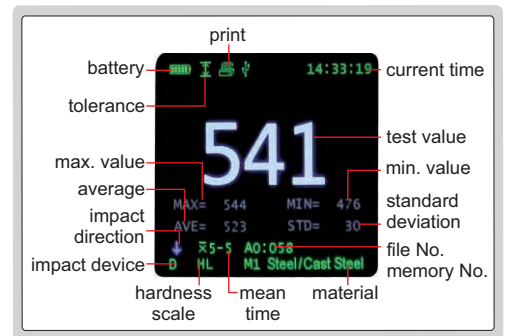
dynamic ring display



statistic display



can choose large font display

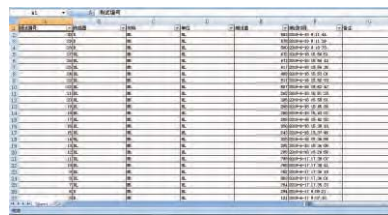


Software (included), upload the memory to PC, print and send to EXCEL

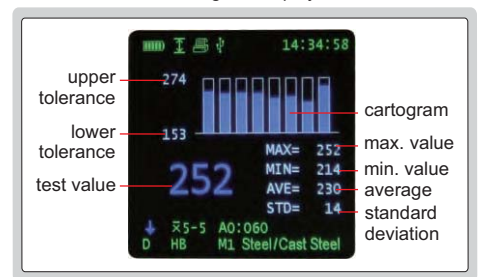
upload the memory to PC software via USB cable or Bluetooth



send the stored data to EXCEL



histogram display



SPECIFICATION

Resolution	1HLD, 1HV, 1HB, 0.1HRC, 0.1HRB, 0.1HRA, 0.1HS, 1SGM	
Accuracy	±4HLD (when HLD=800)	
Output	USB and bluetooth	
Applicable workpiece	minimum weight	5kg (direct measurement)
		2kg (on solid support)
		0.05kg (coupled on plate)
	minimum thickness: 5mm	
minimum radius of curved surface: 30mm		
maximum roughness (Ra): 2µm		
Power supply	built-in 3.7V rechargeable battery	
Dimension	148×44×22mm	
Weight	115g	

STANDARD DELIVERY

Main unit	1 pc
Hardness test block D	1 pc
Small support ring	1 pc
Cleaning brush	1 pc
AC/DC adapter	1 pc
Software disc and USB cable	1 pc

OPTIONAL ACCESSORY

Printer	HDT-L410-PRINTER
Support rings	see details
Hardness test block D	HDT-B-HLD3
DL probe	HDT-L410-DL

PORTABLE LEEB HARDNESS TESTER (BASIC TYPE) CODE HDT-L411

DATA
OUTPUT

INSPECTION
CERTIFICATE



software CD
(included)



VIDEO



hardness test
block D (included)

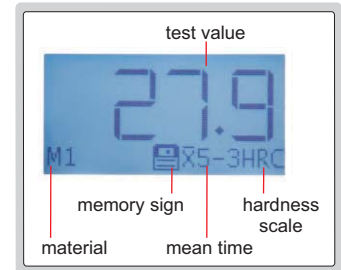


small support ring
(included)



- Impact device D
- Universal testing angle, no need to set impact direction
- Dual-coil probe, high accuracy
- Based on Leeb (HLD), converted to Vickers (HV), Brinell (HB), Rockwell (HRC, HRA and HRB), Shore (HS) and tensile strength (SGM)
- Dual value display, shows both Leeb and converted hardness
- High contrast digital LCD display
- Can choose large font display
- Automatically calculate maximum, minimum, average value
- Connected to PC via USB
- Save 999 data
- Operating temperature: -20°C~45°C
- According to ASTM A956, DIN 50156, GB/T 17394

can choose large font display



Software (included), upload the memory
to PC, print and send to EXCEL

upload the memory to PC
software via USB cable



send the stored data to EXCEL



SPECIFICATION

Resolution	1HLD, 1HV, 1HB, 0.1HRC, 0.1HRB, 0.1HRA, 0.1HS, 1SGM	
Accuracy	±6HLD (when HLD=800)	
Output	USB	
Measuring range	HL100-960, HRC1-74.7, HRB1.2-140, HB28-1027, HV45-1230, HS4-112, HRA7-88.5, SGM (m) 118-3315N/mm ²	
Applicable workpiece	minimum weight	5kg (direct measurement)
		2kg (on solid support)
		0.05kg (coupled on plate)
	minimum thickness: 5mm	
minimum radius of curved surface: 30mm		
maximum roughness (Ra): 2µm		
Power supply	1xAAA battery	
Dimension	148×45×21mm	
Weight	105g	

STANDARD DELIVERY

Main unit	1 pc
Hardness test block D	1 pc
Cleaning brush	1 pc
AAA battery	1 pc
Small support ring	1 pc
Software disc and USB cable	1 pc

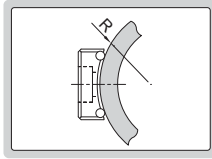
OPTIONAL ACCESSORY

Support rings	see details
Hardness test block D	HDT-B-HLD3

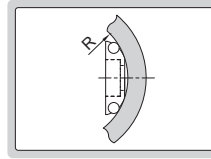


SUPPORT RING SET FOR PORTABLE LEEB HARDNESS TESTER CODE ISH-PH-SP9

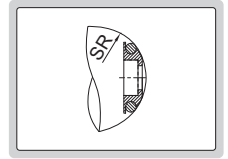
type A



type B



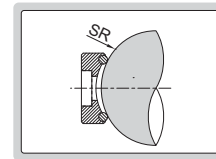
type C



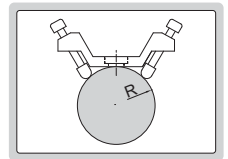
SPECIFICATION

Type	Applicable workpieces	Range (mm)	Quantity
A	cylindrical outside surface	R10-15	3 pcs
		R14.5-30	
		R25-50	
B	cylindrical inside surface	R11-13	3 pcs
		R12.5-17	
		R16.5-30	
C	spherical inside surface	SR11-13	3 pcs
		SR12.5-17	
		SR16.5-30	
D	spherical outside surface	SR10-15	2 pcs
		SR14.5-30	
E	cylindrical outside surface	R>10	1 pc

type D



type E



DIGITAL MAGNETIC ROCKWELL HARDNESS TESTER CODE ISHR-D121



flat anvil for test block
(included)



- Apply to large and heavy steel or iron workpieces
- With statistic function, display average, maximum and minimum values
- Convert to HV, HB and tensile strength
- According to ISO 6508, ASTM E18

SPECIFICATION

Hardness scale	HRA, HRB, HRC
Preliminary test force	10kg
Test force	60kg, 100kg, 150kg
Load control	manual
Min. reading	0.1HR
Flat workpiece requirement	length>190mm, width>60mm, thickness>5mm
Cylinder or tube workpiece requirement	length>200mm, diameter>Ø50mm, wall thickness>8mm
Power supply	3×AAA batteries
Dimension	245×105×230mm
Weight	5.3kg

STANDARD DELIVERY

Main unit	1 pc
Flat anvil	1 pc
Diamond indenter	1 pc
Ø1.5875mm carbide ball indenter	1 pc
Hardness test block HRB85~95	1 pc
Hardness test block HRC60~70	1 pc
Hardness test block HRC20~30	1 pc

MAGNETIC ROCKWELL HARDNESS TESTER CODE ISHR-M111

- Apply to large and heavy steel or iron workpieces
- According to ISO 6508, ASTM E18



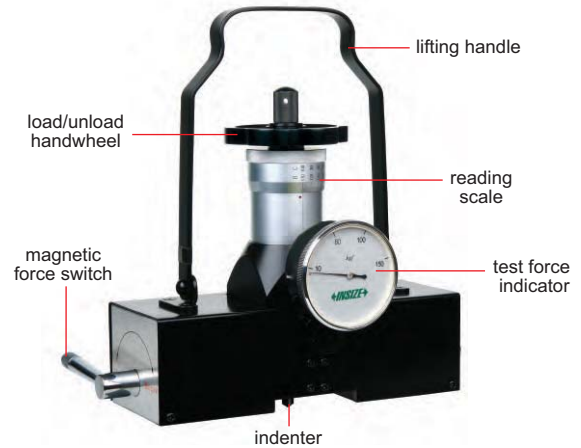
flat anvil for test block
(included)



supports for cylinder or
tube workpieces (included)



magnifier with LED
(included)



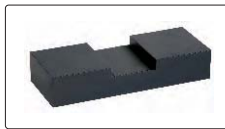
SPECIFICATION

Hardness scale	HRA, HRB, HRC, HRD, HRF, HRG
Preliminary test force	10kg
Test force	60kg, 100kg, 150kg
Load control	manual
Min. reading	1HR
Flat workpiece requirement	length>180mm, width>60mm, thickness>5mm
Cylinder or tube workpiece requirement	length>180mm, diameter>Ø50mm, wall thickness>8mm
Dimension	220×70×220mm
Weight	4.7kg

STANDARD DELIVERY

Main unit	1 pc
Diamond indenter	1 pc
Ø1.5875mm carbide ball indenter	2 pcs
Hardness test block HRB85~95	1 pc
Hardness test block HRC60~70	1 pc
Hardness test block HRC20~30	1 pc
Flat anvil	1 pc
Support	4 pcs
Magnifier with LED	1 pc

MAGNETIC BRINELL/ROCKWELL HARDNESS TESTER CODE ISHR-B141



flat anvil for test block
(included)



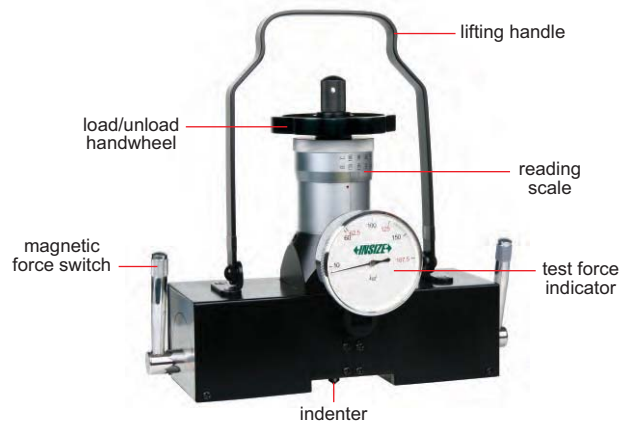
supports for cylinder or
tube workpieces (included)



magnifier with LED
(included)



measuring microscope
(included)



- Apply to large steel or iron workpieces
- According to ISO 6508, ASTM E18

SPECIFICATION

Rockwell scale	HRA, HRB, HRC, HRD, HRF, HRG
Brinell measuring range	20~650HBW
Rockwell test force	10kg preload, 60kg, 100kg, 150kg total load
Brinell test force	62.5kg, 125kg, 187.5kg
Load control	manual
Min. Rockwell reading	1HR
Measuring microscope	40X, graduation 0.01mm
Flat workpiece requirement	length>180mm, width>60mm, thickness>5mm
Cylinder and tube workpiece requirement	length>180mm, diameter>Ø50mm, thickness>8mm
Dimension	220×70×220mm
Weight	4.7kg

STANDARD DELIVERY

Main unit	1 pc
Flat anvil	1 pc
Support	4 pcs
Diamond Rockwell indenter	1 pc
Ø1.5875mm carbide ball indenter	1 pc
Ø2.5mm Brinell indenter	1 pc
Hardness test block HRB85~95	1 pc
Hardness test block HRC60~70	1 pc
Hardness test block HRC20~30	1 pc
Brinell test block	1 pc
Measuring microscope	1 pc
Magnifier with LED	1 pc

PORTABLE ROCKWELL HARDNESS TESTER CODE ISHR-P151



flat anvil (included)



V-type anvil (included)



anvil extension for thin workpieces (included)

- According to ISO 6508, ASTM E18

SPECIFICATION

Hardness scale	HRA, HRB, HRC, HRD, HRF, HRG
Preliminary test force	10kg
Test force	60kg, 100kg, 150kg
Load control	manual
Min. reading	1HR
Max. workpiece thickness	25mm
Max. testing width	25mm (from the center of indenter to the main body)
Dimension	240×70×160mm
Weight (with base)	2.5kg

STANDARD DELIVERY

Main unit	1 pc
Diamond indenter	1 pc
Ø1.5875mm carbide ball indenter	2 pcs
Hardness test block HRB88-95	1 pc
Hardness test block HRC60-65	1 pc
Hardness test block HRC20-30	1 pc
Flat anvil	1 pc
V-type anvil	1 pc
Base	1 pc
Anvil extension	1 pc
Magnifier	2 pcs



- Measure Brinell hardness of large and heavy workpieces
- 1580kg test force and Ø7.26mm ball indenter, equal to 3000kg test force and Ø10mm ball indenter
- Static and impact test modes
- According to ISO and ASTM standard

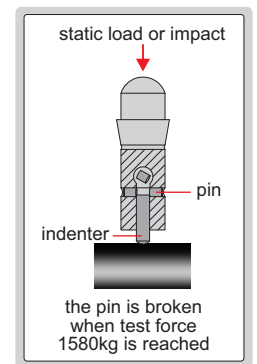
PIN BRINELL HARDNESS TESTER CODE ISHB-P101



static test clamp



impact test handle



static test



impact test



measuring microscope (included)



pins (included)



V-type anvil (included)

SPECIFICATION

Measuring range	100~350HBW (with Ø7.26mm indenter, included) 350~650HBW (with Ø4mm indenter, optional)
Test force	1580kg
Accuracy	static test: ±3% impact test: ±5%
Measuring microscope	20X, graduation 0.01mm
Max. workpiece height of static test	150mm
Max. testing width of static test	80mm (from the center of indenter to the clamp)
Dimension	195×60×350mm
Weight	4.2kg

STANDARD DELIVERY

Static test clamp	1 pc
Impact test handle	1 pc
Flat anvil	1 pc
V-type anvil	1 pc
Ø7.26mm indenter	1 pc
Hardness test block	1 pc
Pin	250 pcs
Measuring microscope	1 pc

OPTIONAL ACCESSORY

Ø4mm indenter	ISHB-P101-INDENTER
Pin (250 pcs)	ISHB-P101-PIN

HYDRAULIC BRINELL HARDNESS TESTER CODE ISHB-H131



V-type anvil
(included)



spherical anvil
(included)

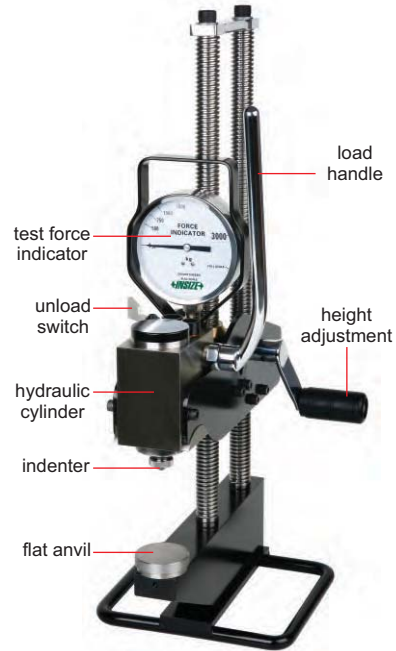


measuring microscope
(included)

- According to ISO 6506, ASTM E10

SPECIFICATION

Measuring range	16~650HBW
Test force	3000kg
Indenter	Ø10mm carbide ball
Measuring microscope	20X, graduation 0.01mm
Max. workpiece height	350mm
Max. testing width	90mm (from the center of indenter to the column)
Dimension	270×225×570mm
Weight	13.8kg



STANDARD DELIVERY

Main unit	1 pc
Flat anvil	1 pc
V-type anvil	1 pc
Spherical anvil	1 pc
Ø10mm carbide ball	2 pcs
Brinell test block	2 pcs
Measuring microscope	1 pc

CHAIN TYPE HYDRAULIC BRINELL HARDNESS TESTER CODE ISHB-C161



measuring microscope
(included)

- To measure the hardness of cylinders or tubes
- According to ISO 6506, ASTM E10



SPECIFICATION

Measuring range	32~650HBW
Workpiece diameter range	Ø150~Ø500mm
Test force	3000kg
Indenter	Ø10mm carbide ball
Measuring microscope	20X, graduation 0.01mm
Dimension	270×225×570mm
Weight	14.5kg

STANDARD DELIVERY

Main unit	1 pc
1.5m chain	1 pc
Ø10mm carbide ball	2 pcs
Brinell test block	2 pcs
Measuring microscope	1 pc

BARCOL HARDNESS TESTER CODE ISHB-B300

- To measure the hardness of workpieces made of pure aluminum, aluminum alloy, fiber reinforced plastic, hard plastic, etc.
- According to ASTM B648-00, ASTM D2853-07



SPECIFICATION

Hardness range	0~100HBa (equal to 25~150HBW)
Min. reading	1HBa
Accuracy	±2HBa (at 42~52HBa) ±1HBa (at 84~88HBa)
Min. workpiece thickness	0.8mm
Dimension	142×65×90mm
Weight	500g

STANDARD DELIVERY

Main unit	1 pc
Spare indenter	2 pcs
Hardness test block	2 pcs
Wrench	1 pc



WEBSTER HARDNESS TESTERS

- To measure the hardness of soft metal such as aluminum alloy, copper, brass, soft steel, etc.
- According to ASTM B647-84 (2000)

STANDARD DELIVERY

Main unit	1 pc
Spare indenter	1 pc
Hardness test block	1 pc
Wrench	1 pc



ISHW-L20

SPECIFICATION

Code	ISHW-L20	ISHW-L20A	ISHW-L20B	ISHW-B70	ISHW-B75	ISHW-B92
Application	for aluminum alloy general use	for aluminum alloy thick workpiece	for aluminum alloy small tube	for hard aluminum alloy and hard brass	for soft brass and copper	for soft steel and cold-rolled steel
Thickness requirement of flat workpiece	0.6~6mm	0.6~13mm	0.6~8mm	0.6~6mm	0.6~6mm	0.6~6mm
Internal diameter requirement of tube workpiece	>Ø10mm	>Ø10mm	>Ø6mm	>Ø10mm	>Ø10mm	>Ø10mm
Wall thickness requirement of tube workpiece	0.6~6mm	6~13mm (internal diameter Ø10~23.3mm) 0.6~6mm (internal diameter >Ø23.3mm)	0.6~8mm	0.6~6mm	0.6~6mm	0.6~6mm
Hardness range	0~20HW					
Min. reading	1HW					
Accuracy	±0.5HW (at 5~17HW)					
Dimension	205×30×85mm					
Weight	500g					

DIGITAL SHORE DUROMETERS

DATA OUTPUT



calibration block (included)

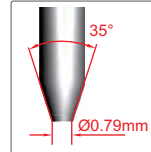


printer (optional)



VIDEO

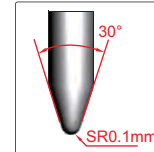
- According to ISO868, ISO7619, ASTM D 2240
- Average and peak (max.) mode
- Dwell time is adjustable
- Tolerance testing
- 500 memories
- Wireless connection to printer
- Handhold use or work with test stand (code **ISH-DS-STANDA**)
- Automatic power off



blunt taper indenter



ISH-DSA



sharp point indenter



ISH-DSD



software CD (included)

SPECIFICATION

Code	ISH-DSA	ISH-DSD
Unit	Shore A	Shore D
Test material	soft plastic, soft rubber, etc.	hard plastic, hard rubber, etc.
Measuring range	0~100HA	0~100HD
Resolution	0.1HA	0.1HD
Accuracy	±1HA	±1HD
Indenter protrusion	2.5mm	
Output	wireless and USB	
Power supply	built-in rechargeable battery	
Dimension	153×50×29mm	
Weight	170g	

- * Use **ISH-DSD** when measuring result is higher than 90HA
Use **ISH-DSA** when measuring result is lower than 20HD

STANDARD DELIVERY

Main unit	1 pc
Calibration block	1 pc
Software and USB cable	1 pc
AC/DC adapter	1 pc

OPTIONAL ACCESSORY

Printer	ISH-DS-PRINTER
Test stand	ISH-DS-STANDA

TEST STAND FOR DIGITAL SHORE DUROMETERS CODE ISH-DS-STANDA

- For digital shore durometers (code **ISH-DSA** and **ISH-DSD**)
- Perform repeatable hardness measurement due to fewer possibilities of human error or measurement variations
- Special structure for stable loading
- Weight block A (included) is for **ISH-DSA**, weight block D (optional) is for **ISH-DSD**



weight block D (optional) for ISH-DSD

SPECIFICATION

Stage diameter	Ø115mm
Max. workpiece height	45mm
Max. testing width	63mm (from test point to the column)
Dimension	Ø195×370mm
Weight	5.61kg

STANDARD DELIVERY

Test stand	1 pc
Weight block A (for ISH-DSA)	1 pc

OPTIONAL ACCESSORY

Weight block D (for ISH-DSD)	ISH-DS-W4
------------------------------	-----------

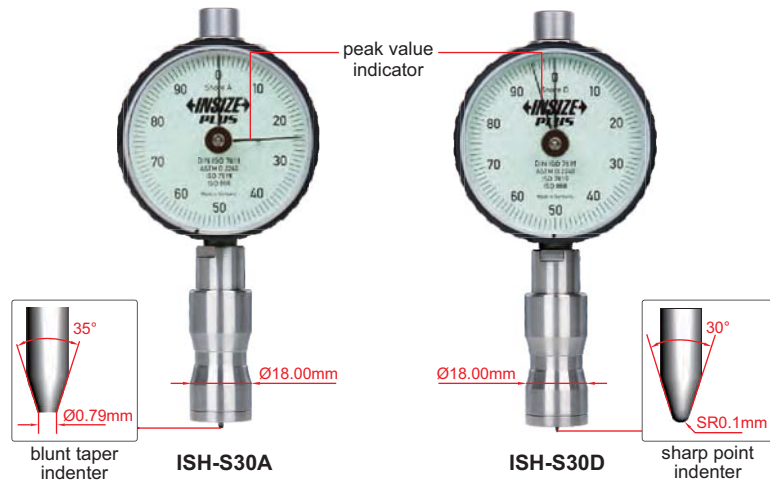


SHORE DUROMETERS

INSIZE PLUS
MADE IN EUROPE



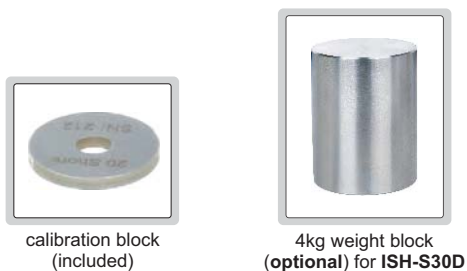
- According to ISO868, ISO7619, ASTM D 2240
- With peak value indicator
- Handhold use or work with test stand (code **ISH-OS2**)



SPECIFICATION

Code	ISH-S30A	ISH-S30D
Scale	Shore A	Shore D
Test material	soft plastic, soft rubber, etc.	hard plastic, hard rubber, etc.
Measuring range *	0~100HA	0~100HD
Resolution	1HA	1HD
Accuracy	±0.5HA	±0.5HD
Indenter protrusion	2.5mm	
Weight	184g	

* Use **ISH-S30D** when measuring result is higher than 90HA
Use **ISH-S30A** when measuring result is lower than 20HD



calibration block
(included)

4kg weight block
(optional) for **ISH-S30D**

- For shore durometers (code **ISH-S30A** and **ISH-S30D**)
- Perform repeatable hardness measurement due to fewer possibilities of human error or measurement variations
- Special structure for stable loading
- 1kg weight block (included) is for **ISH-S30A**,
4kg weight block (optional) is for **ISH-S30D**

SPECIFICATION

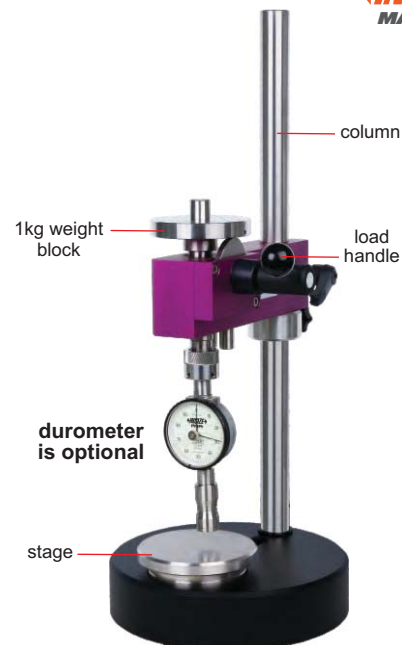
Stage diameter	Ø98mm
Max. workpiece height	180mm
Max. testing width	115mm (from test point to the column)
Dimension	Ø200×500mm
Weight	18kg

STANDARD DELIVERY

Test stand	1 pc
1kg weight block (for ISH-S30A)	1 pc
Calibration block	1 pc

TEST STAND FOR SHORE DUROMETERS CODE **ISH-OS2**

INSIZE PLUS
MADE IN EUROPE



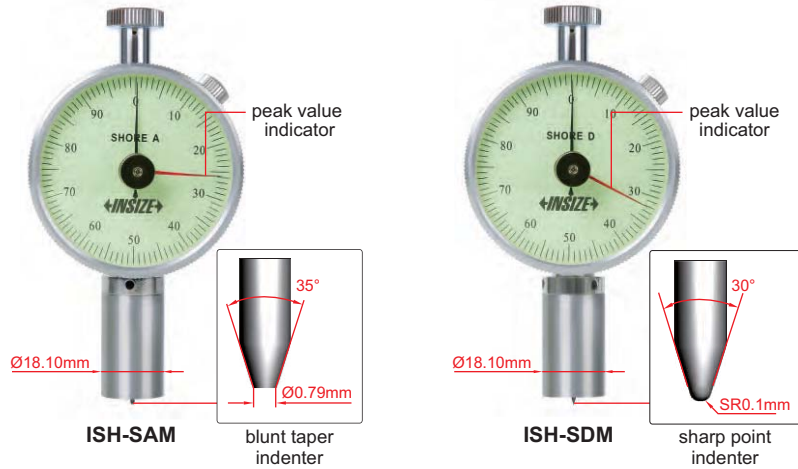
OPTIONAL ACCESSORY

4kg weight block (for ISH-S30D)	ISH-OS2-W4
---	-------------------

SHORE DUROMETERS



- According to ISO868, ISO7619, ASTM D 2240
- With peak value indicator
- Optional accessory: test stand **ISH-STAC** and **ISH-STD**

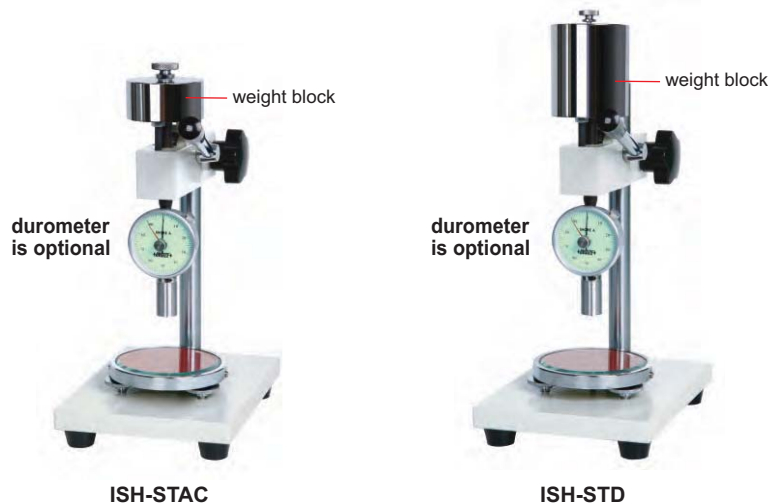


SPECIFICATION

Code	ISH-SAM	ISH-SDM
Scale	Shore A	Shore D
Application	nature rubber, soft elastomer, etc.	hard rubber, plastic, hard elastomer, etc.
Measuring range *	10~90HA	20~90HD
Graduation	1HA	1HD
Indenter protrusion	2.5mm	
Dimension	115×60×25mm	
Weight	160g	

- * Use **ISH-SDM** when measuring result is higher than 90HA
Use **ISH-SAM** when measuring result is lower than 20HD

TEST STANDS FOR SHORE DUROMETERS



- For shore durometers (code **ISH-SAM** and **ISH-SDM**)
- Perform repeatable hardness measurement due to fewer possibilities of human error or measurement variations

SPECIFICATION

Code	ISH-STAC	ISH-STD
Applicable durometer	ISH-SAM	ISH-SDM
Stage diameter	Ø100mm	Ø100mm
Max. workpiece height	75mm	75mm
Max. testing width	65mm (from test point to the column)	65mm (from test point to the column)
Weight block	1kg	5kg

HARDNESS TEST BLOCKS



Rockwell



Vickers



Leeb



Micro-Vickers



Brinell



Shore

■ Supplied with manufacturer inspection certificate

Rockwell hardness test blocks

Code	Type	Hardness
HDT-B-HRA	HRA	80-84
HDT-B-HRB	HRB	88-100
HDT-B-HRC1	HRC	20-30
HDT-B-HRC2	HRC	35-55
HDT-B-HRC3	HRC	60-70
HDT-B-HRD1	HRD	40-47
HDT-B-HRD2	HRD	55-63
HDT-B-HRD3	HRD	70-75
HDT-B-HRE	HRE	107-114
HDT-B-HRF	HRF	105-114
HDT-B-HRG1	HRG	57-82
HDT-B-HRG2	HRG	80-94

Rockwell superficial hardness test blocks

Code	Type	Hardness
HDT-B-HR15N1	HR15N	70-77
HDT-B-HR15N2	HR15N	78-88
HDT-B-HR15N3	HR15N	89-91
HDT-B-HR30N1	HR30N	42-54
HDT-B-HR30N2	HR30N	55-73
HDT-B-HR30N3	HR30N	74-80
HDT-B-HR45N1	HR45N	20-31
HDT-B-HR45N2	HR45N	32-61
HDT-B-HR45N3	HR45N	63-70
HDT-B-HR15T	HR15T	88-93
HDT-B-HR30T	HR30T	73-82
HDT-B-HR45T	HR45T	58-72

Leeb hardness test blocks

Code	Type	Hardness
HDT-B-HLD1	HLD	490-570
HDT-B-HLD2	HLD	590-670
HDT-B-HLD3	HLD	750-830
HDT-B-HLG1	HLG	460-540
HDT-B-HLG2	HLG	550-630

Vickers hardness test blocks

Code	Type	Hardness
HDT-B-HV5A	HV5	175-200
HDT-B-HV5B	HV5	200-300
HDT-B-HV5C	HV5	300-400
HDT-B-HV5D	HV5	400-500
HDT-B-HV5E	HV5	500-600
HDT-B-HV5F	HV5	600-700
HDT-B-HV5G	HV5	700-750
HDT-B-HV10A	HV10	175-200
HDT-B-HV10B	HV10	200-300
HDT-B-HV10C	HV10	300-400
HDT-B-HV10D	HV10	400-500
HDT-B-HV10E	HV10	500-600
HDT-B-HV10F	HV10	600-700
HDT-B-HV10G	HV10	700-750
HDT-B-HV30A	HV30	175-200
HDT-B-HV30B	HV30	200-300
HDT-B-HV30C	HV30	300-400
HDT-B-HV30D	HV30	400-500
HDT-B-HV30E	HV30	500-600
HDT-B-HV30F	HV30	600-700
HDT-B-HV30G	HV30	700-750
HDT-B-HV50A	HV50	175-200
HDT-B-HV50B	HV50	200-300
HDT-B-HV50C	HV50	300-400
HDT-B-HV50D	HV50	400-500
HDT-B-HV50E	HV50	500-600
HDT-B-HV50F	HV50	600-700
HDT-B-HV50G	HV50	700-750
HDT-B-HV100A	HV100	175-200
HDT-B-HV100B	HV100	200-300
HDT-B-HV100C	HV100	300-400
HDT-B-HV100D	HV100	400-500
HDT-B-HV100E	HV100	500-600
HDT-B-HV100F	HV100	600-700
HDT-B-HV100G	HV100	700-750

To be continued

Continued from previous page

Micro-Vickers hardness test blocks

Code	Type	Hardness
HDT-B-HV005A	HV0.05	200-300
HDT-B-HV005B	HV0.05	300-400
HDT-B-HV005C	HV0.05	400-500
HDT-B-HV005D	HV0.05	500-600
HDT-B-HV005E	HV0.05	600-700
HDT-B-HV005F	HV0.05	700-750
HDT-B-HV01A	HV0.1	200-300
HDT-B-HV01B	HV0.1	300-400
HDT-B-HV01C	HV0.1	400-500
HDT-B-HV01D	HV0.1	500-600
HDT-B-HV01E	HV0.1	600-700
HDT-B-HV01F	HV0.1	700-750
HDT-B-HV02A	HV0.2	200-300
HDT-B-HV02B	HV0.2	300-400
HDT-B-HV02C	HV0.2	400-500
HDT-B-HV02D	HV0.2	500-600
HDT-B-HV02E	HV0.2	600-700
HDT-B-HV02F	HV0.2	700-750
HDT-B-HV03A	HV0.3	200-300
HDT-B-HV03B	HV0.3	300-400
HDT-B-HV03C	HV0.3	400-500
HDT-B-HV03D	HV0.3	500-600
HDT-B-HV03E	HV0.3	600-700
HDT-B-HV03F	HV0.3	700-750
HDT-B-HV05A	HV0.5	200-300
HDT-B-HV05B	HV0.5	300-400
HDT-B-HV05C	HV0.5	400-500
HDT-B-HV05D	HV0.5	500-600
HDT-B-HV05E	HV0.5	600-700
HDT-B-HV05F	HV0.5	700-750
HDT-B-HV1A	HV1	200-300
HDT-B-HV1B	HV1	300-400
HDT-B-HV1C	HV1	400-500
HDT-B-HV1D	HV1	500-600
HDT-B-HV1E	HV1	600-700
HDT-B-HV1F	HV1	700-750

Shore hardness test blocks

Code	Type	Hardness
HDT-B-SA	SA	6 pcs/set
HDT-B-SD	SD	3 pcs/set

Brinell hardness test blocks

Code	Type	Hardness
HDT-B-HB10A1	HBW10/3000	100-200
HDT-B-HB10A2	HBW10/3000	200-300
HDT-B-HB10A3	HBW10/3000	300-400
HDT-B-HB10A4	HBW10/3000	400-500
HDT-B-HB10A5	HBW10/3000	500-600
HDT-B-HB10A6	HBW10/3000	600-650
HDT-B-HB10B1	HBW10/1500	100-200
HDT-B-HB10B2	HBW10/1500	200-300
HDT-B-HB10B3	HBW10/1500	300-400
HDT-B-HB10B4	HBW10/1500	400-500
HDT-B-HB10B5	HBW10/1500	500-600
HDT-B-HB10B6	HBW10/1500	600-650
HDT-B-HB10C1	HBW10/1000	90-200
HDT-B-HB10C2	HBW10/1000	200-300
HDT-B-HB10C3	HBW10/1000	300-400
HDT-B-HB10C4	HBW10/1000	400-450
HDT-B-HB10D1	HBW10/500	90-200
HDT-B-HB10D2	HBW10/500	200-300
HDT-B-HB10D3	HBW10/500	300-400
HDT-B-HB10D4	HBW10/500	400-450
HDT-B-HB25A1	HBW2.5/187.5	100-200
HDT-B-HB25A2	HBW2.5/187.5	200-300
HDT-B-HB25A3	HBW2.5/187.5	300-400
HDT-B-HB25A4	HBW2.5/187.5	400-500
HDT-B-HB25A5	HBW2.5/187.5	500-600
HDT-B-HB25A6	HBW2.5/187.5	600-650
HDT-B-HB25B1	HBW2.5/62.5	90-200
HDT-B-HB25B2	HBW2.5/62.5	200-300
HDT-B-HB25B3	HBW2.5/62.5	300-400
HDT-B-HB25B4	HBW2.5/62.5	400-450
HDT-B-HB5A1	HBW5/750	100-200
HDT-B-HB5A2	HBW5/750	200-300
HDT-B-HB5A3	HBW5/750	300-400
HDT-B-HB5A4	HBW5/750	400-500
HDT-B-HB5A5	HBW5/750	500-600
HDT-B-HB5A6	HBW5/750	600-650
HDT-B-HB5B1	HBW5/250	90-200
HDT-B-HB5B2	HBW5/250	200-300
HDT-B-HB5B3	HBW5/250	300-400
HDT-B-HB5B4	HBW5/250	400-450

FRUIT HARDNESS TESTER

23

- Measure the hardness of apples, pears, strawberries and grapes, etc.
- The degree of ripeness can be judged by measuring the hardness of the fruit

SPECIFICATION

Code	Range	Graduation	Accuracy	Probe diameter	Probe depth	Dimension	Weight
9643-4	0.5-4kg/cm ² (0.5-4×10 ⁵ Pa)	0.02kg/cm ² (0.02×10 ⁵ Pa)	±2%	Ø3.5mm	10mm	151×55×30mm	0.2kg



9643-4

DATA
OUTPUT

CONCRETE STRENGTH TESTERS



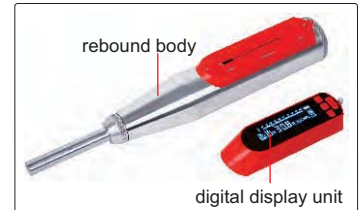
CST-D101



CST-D102

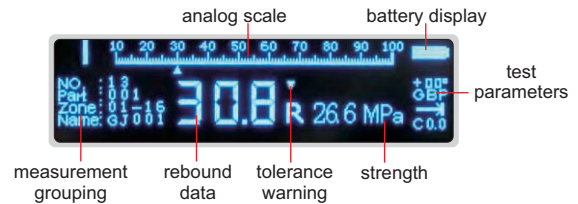


VIDEO



CST-D102 separable

- Measure the strength of general building components, bridges and various concrete components (slabs, beams, columns, bridges, etc.)
- Angle, test surface, pumping, carbonization depth and other parameters can be customized according to the requirements
- The rebound body can be used for 2000 times
- USB data transmission
- The software can automatically generate the test report, and the strength curve can be customized and stored in the tester
- Storage and reading of 1000 test data
- According to JGJ / T23-2011, the curve of rebound meter can be customized to calculate the compressive strength of concrete



SPECIFICATION

Code	CST-D101	CST-D102
Display	OLED display	
Range	10-70N/mm ²	
Accuracy	±1R	
Parameter	MPa, N/mm ² , Kg/mm ²	
Impact energy	2.207J, for testing common buildings or bridge structures	
Output	USB	
Structure	one body, non-seperable	separable, the digital display unit can be reused
Memory	1000 data	
Operating temperature	-40°C~60°C	
Power supply	built-in rechargeable battery	
Dimension	280×75×60mm	
Weight	1.1Kg	



software CD (included)



sander (included)

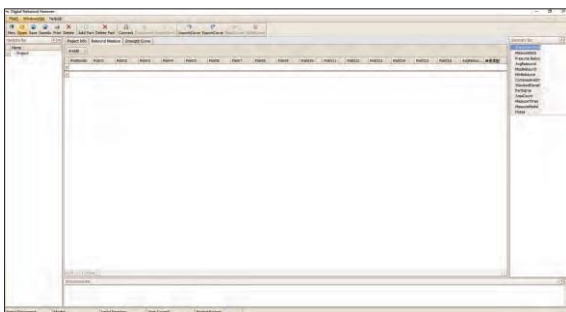
STANDARD DELIVERY

Main unit	1 pc
Sander	1 pc
Power adapter	1 pc
Software and USB cable	1 pc

OPTIONAL ACCESSORY

Rebound body (for CST-D102)	CST-D102-REBOUND
Digital display unit (for CST-D102)	CST-D102-DISPLAY

Software (included) for uploading and storing data, printing and importing/exporting strength curves



	A	B	C	D	E	F	G
1	1	15.2					
2	2	15.2					
3	3	15.8					
4	4	15.8					
5	5	15.8					
6	6	16.2					
7	7	16.2					
8	8	16.4					
9	9	16.6					
10	10	16.8					
11	11	17					
12	12	17.2					
13	13	17.4					
14	14	17.4					
15	15	17.6					
16	16	17.8					
17	17	18					
18	18	18.2					
19	19	18.4					
20	20	18.6					
21	21	18.8					
22	22	19					
23	23	19.2					
24	24	19.4					
25	25	19.6					
26	26	19.8					
27	27	20	1.7	3.3	13.4	8.3	
28	28	20.2	1.8	3.5	13.6	8.4	
29	29	20.4	1.8	3.5	13.7	8.5	

Concrete compressive strength report detected by rebound method						
Report Name	Project	Testing Unit	Scale	Report Date	2018-11-17 00	Report Date
Construction Unit	Contractor Unit	Inspector	Inspector	Inspector	Inspector	Inspector
Test No.	Test Date	Test Area	Area	ETOR	Strength	Strength
Test No.	Result	The type of brick	Rebound value (1-10)	Area value	Area value	Area value
1						
2						
3						
4						
5						
6						
7						
8						
9						
10						
11						
12						
13						
14						
15						
16						
17						
18						
19						
20						
21						
22						
23						
24						
25						
26						
27						
28						
29						

DIGITAL FORCE GAGES (HIGH ACCURACY)



INSPECTION
CERTIFICATE

DATA
OUTPUT

printer (optional)



software CD
(included)



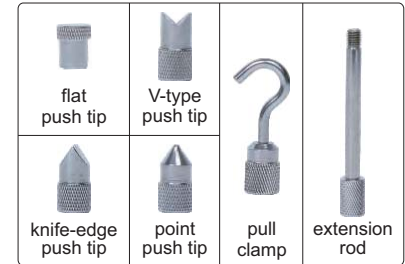
- Push and pull test
- Peak (max.) and tracking mode
- Units: mN, N, gf, kgf, ozf, lbf, MPa (only for type B)
- Tolerance testing
- 1000 memories
- Automatic power off
- Metal case, touch buttons
- LCD display with backlight
- The display flips over when the bottom faces up
- Overload alarm



ISF-DF100A
type A

ISF-DF5KA
type B

accessory for type A (included)



accessory for type B (included)



SPECIFICATION

Code	ISF-DF 5A	ISF-DF 10A	ISF-DF 20A	ISF-DF 50A	ISF-DF 100A	ISF-DF 200A	ISF-DF 500A	ISF-DF 1KA	ISF-DF 2KA	ISF-DF 5KA	ISF-DF 10KA	ISF-DF 20KA
Type	A (internal sensor)								B (external sensor)			
Load capacity (N)	5	10	20	50	100	200	500	1000	2000	5000	10000	20000
Resolution (N)	0.0005	0.001	0.005	0.005	0.01	0.05	0.05	0.1	0.5	0.5	1	5
Accuracy	±0.2% (of load capacity)											
Power supply	built-in rechargeable battery											

STANDARD DELIVERY

Code	ISF-DF 5A	ISF-DF 10A	ISF-DF 20A	ISF-DF 50A	ISF-DF 100A	ISF-DF 200A	ISF-DF 500A	ISF-DF 1KA	ISF-DF 2KA	ISF-DF 5KA	ISF-DF 10KA	ISF-DF 20KA
Main unit	1 pc								1 pc			
AC/DC adapter	1 pc								1 pc			
Software and USB cable	1 pc								1 pc			
Push/pull accessory	6 pcs (flat push tip, V-type push tip, knife-edge push tip, point push tip, pull clamp, extension rod)								4 pcs (flat push tip, adapter, pull clamps)			

OPTIONAL ACCESSORY

Printer	ISF-DF-PRINTER
Test stand	ISF-MT1K

TEST STAND FOR DIGITAL FORCE GAGE CODE ISF-MT1K

- For digital force gages (code ISF-1DF□□□ and ISF-DF□□□)
- To be used in vertical and horizontal orientation

SPECIFICATION

Load capacity	1000N
Travel	200mm (3mm vertical movement per revolution of handwheel)
Dimension	196x250x446mm
Weight	13kg

OPTIONAL ACCESSORY

Digital scale (range: 200mm, resolution: 0.01mm/0.0005")	ISF-MT1K-SCALE
--	----------------

force gage
is optional



digital scale (optional)

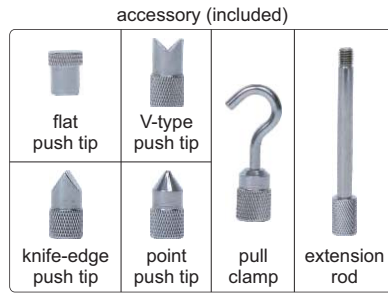


horizontal orientation test



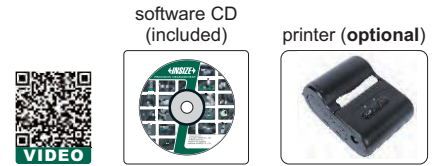
DATA OUTPUT

- Push and pull test
- Units: N, gf, kgf, ozf, lbf
- 500 memories
- Automatic power off
- Metal case
- LCD display with backlight
- The display flips over when the bottom faces up
- Overload alarm



ISF-1DF100

DIGITAL FORCE GAGES



STANDARD DELIVERY

Main unit	1 pc
AC/DC adapter	1 pc
Software and USB cable	1 pc
Push/pull accessory	6 pcs (flat push tip, V-type push tip, knife-edge push tip, point push tip, pull clamp, extension rod)

OPTIONAL ACCESSORY

Printer	ISF-DF-PRINTER
Test stand	ISF-MT1K

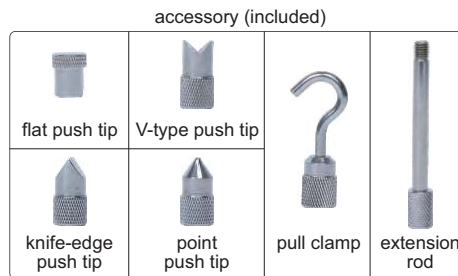
SPECIFICATION

Code	ISF-1DF10	ISF-1DF50	ISF-1DF100	ISF-1DF500	ISF-1DF1000
Load capacity (N)	10	50	100	500	1000
Resolution (N)	0.01	0.01	0.1	0.1	1
Accuracy	±0.3% (of load capacity)				
Measuring mode	tracking, peak (max.), tolerance testing				
Power supply	built-in rechargeable battery				
Dimension	150×73×33mm				
Weight	450g				

- Push and pull test
- Peak (max.) or tracking mode

STANDARD DELIVERY

Main unit	1 pc
Push tip	4 pcs (flat, V type, knife-edge, point)
Pull clamp	1 pc
Extension rod	1 pc



ISF-F500



SPECIFICATION

Code		ISF-F10	ISF-F20	ISF-F30	ISF-F50	ISF-F100	ISF-F200	ISF-F300	ISF-F500
Capacity	N	10	20	30	50	100	200	300	500
	kgf	1	2	3	5	10	20	30	50
Graduation	N	0.05	0.1	0.2	0.25	0.5	1	2	2.5
Accuracy		±1% (of load capacity)							

OPTIONAL ACCESSORY

Test stand	ISF-MT500
------------	-----------

TEST STAND FOR FORCE GAGE CODE ISF-MT500

- For force gages (code ISF-F□□□)
- To be used in vertical and horizontal orientation



SPECIFICATION

Load capacity	500N
Travel	150mm (3mm vertical movement per revolution of handwheel)
Dimension	160×240×460mm
Weight	12kg

force gage is optional



horizontal orientation test

MANUAL VERTICAL TEST STANDS FOR FORCE GAGES

ATTENTION:
ONLY FOR PRESS TEST



- For press test with force gages

SPECIFICATION

Code	ISF-V10A	ISF-V10D
Apply to	dial force gages (code ISF-1F□□□)	digital force gages (code ISF-1DF□□□ and ISF-DF□□□)
Load capacity	500N	
Maximum workpiece height	280mm	
Travel	70mm	
Dimension	152×235×425mm	
Weight	10.7kg	

force gage
is optional



ISF-V10A

MANUAL HORIZONTAL TEST STANDS FOR FORCE GAGES

ATTENTION:
ONLY FOR PULL TEST



- For pull test with force gages

SPECIFICATION

Code	ISF-H20A	ISF-H20D
Apply to	dial force gages (code ISF-1F□□□)	digital force gages (code ISF-1DF□□□ and ISF-DF□□□)
Load capacity	500N	
Travel	60mm	
Dimension	450×185×170mm	
Weight	9kg	

force gage
is optional



ISF-H20A

MANUAL STRIPPING FORCE TEST STANDS

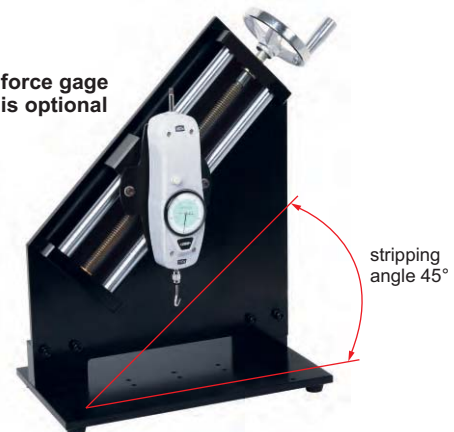


- For stripping force test with force gages

SPECIFICATION

Code	ISF-P30A	ISF-P30D
Apply to	dial force gages (code ISF-1F□□□)	digital force gages (code ISF-1DF□□□ and ISF-DF□□□)
Load capacity	500N	
Horizontal travel	170mm	
Dimension	420×215×480mm	
Weight	22kg	

force gage
is optional



stripping
angle 45°

ISF-P30A

DATA
OUTPUT

DIGITAL SPRING TESTERS

- Peak hold and automatic release function
- Set upper and lower limits, red and green indicator and buzzer alarm
- Automatic conversion of three units: N, kgf, lbf
- Built in printer
- Automatic power off



ISF-S10



ISF-S500



ISF-S1000

SPECIFICATION

Code	ISF-S10*	ISF-S20*	ISF-S30*	ISF-S50*	ISF-S100*	ISF-S200*
Maximum load	10N	20N	30N	50N	100N	200N
Resolution	0.001N	0.002N	0.01N	0.01N	0.02N	0.05N
Range of digital scale	65mm	65mm	65mm	95mm	95mm	95mm
Resolution of digital scale	0.01mm	0.01mm	0.01mm	0.01mm	0.01mm	0.01mm
Disk diameter	Ø30mm	Ø30mm	Ø30mm	Ø49mm	Ø49mm	Ø49mm
Maximum free length of spring	65mm	65mm	65mm	95mm	95mm	95mm
Measuring range of force	5%~100% (maximum load)					
Accuracy of force	±1% (maximum load)					
Data output	RS232					
Power supply	220V, 50/60Hz*					
Dimension	300×235×600mm	300×235×600mm	300×235×600mm	300×235×620mm	300×235×620mm	300×235×620mm
Weight	13.2kg	13.2kg	13.2kg	17.3kg	19.1kg	19.1kg

Code	ISF-S300*	ISF-S500*	ISF-S1000*	ISF-S2000*	ISF-S5000*
Maximum load	300N	500N	1000N	2000N	5000N
Resolution	0.1N	0.1N	0.2N	0.5N	1N
Range of digital scale	95mm	95mm	150mm	150mm	150mm
Resolution of digital scale	0.01mm	0.01mm	0.01mm	0.01mm	0.01mm
Disk diameter	Ø49mm	Ø49mm	Ø108mm	Ø108mm	Ø108mm
Maximum free length of spring	95mm	95mm	200mm	200mm	200mm
Measuring range of force	5%~100% (maximum load)				
Accuracy of force	±1% (maximum load)				
Data output	RS232				
Power supply	220V, 50/60Hz*				
Dimension	300×235×620mm	300×235×620mm	490×300×920mm	490×300×920mm	490×300×920mm
Weight	19.1kg	20.8kg	47.5kg	47.5kg	47.5kg

*Add "-U" on code No. when power supply is 110V, 50/60Hz

STANDARD DELIVERY

Main unit	1 pc
Power supply adapter	1 pc

ELECTRONIC UNIVERSAL TESTING MACHINES



flat jaws (included)

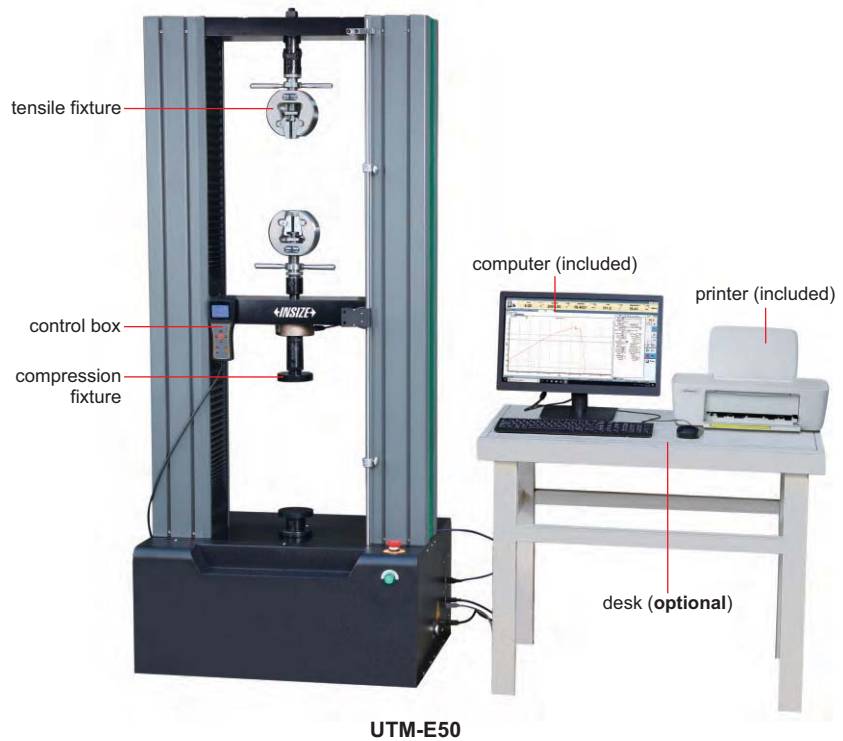


V-shaped jaws (included)

- For tensile, compression, bend, shear, peel, tear tests of metal and non-metal materials

STANDARD DELIVERY

Main unit	1 pc
Control box	1 pc
Computer	1 pc
Measuring software	1 pc
Printer	1 pc
Wedge tension fixture (including flat jaws and V-shaped jaws)	1 set
Compression fixture	1 set
Extensometer (only for UTM-E100, UTM-E300)	1 pc



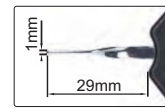
UTM-E50

SPECIFICATION

Code	UTM-E10	UTM-E50	UTM-E100	UTM-E300
Max. test force	10kN	50kN	100kN	300kN
Accuracy class	0.5 class			
Test force measurement range	0.2%~100%FS			
Test force indication accuracy	±0.5% of indicating value			
Resolution of test force measurement	1/300000 of Max. test force (same resolution all the way)			
Deformation measurement range	0.2%~100%FS			
Deformation indication accuracy	±0.5% of indicating value			
Deformation resolution	1/300000 of Max. deformation			
Large deformation measurement range	10~800mm			
Large deformation indication accuracy	±1% of indicating value			
Large deformation resolution	8μm			
Displacement indication accuracy	±0.5% of indicating value			
Displacement resolution	0.025μm			
Force control speed adjustment range	0.005~5%FS/s			
Force control speed control accuracy	±2% of the set value (rate<0.05%FS/s) ±0.5% of the set value (rate≥0.05%FS/s)			
Deformation rate adjustment range	0.2%~100%FS			
Deformation rate control accuracy	±2% of the set value (rate<0.05%FS/s) ±0.5% of the set value (rate≥0.05%FS/s)			
Beam displacement speed adjustment range	0.001~500mm/min			
Beam displacement speed control accuracy	±1% of the set value (rate<0.5mm/min) ±0.2% of the set value (rate≥0.5mm/min)			
Crosshead travel	1030mm	970mm	1250mm	1000mm
Effective compression travel	800mm	700mm	700mm	600mm
Horizontal test space	400mm	440mm	600mm	550mm
Power supply	220V, 50Hz, 0.4kW~1kW		380V, 50Hz, 2kW~5kW	
Dimension	715×500×1680mm	820×620×1880mm	1070×855×2180mm	1070×920×2550mm
Weight	230kg	350kg	1000kg	1500kg

DIAL TENSION GAGES

- Clockwise and counter-clockwise use
- For electronic and precision mechanical industry, such as test the contact pressure of relay, adjust the tension or compression of spring



ISF-TG3

SPECIFICATION (Unit: N)

Code	ISF-TGD1	ISF-TGD3	ISF-TGD5	ISF-TG1	ISF-TG1D5	ISF-TG3	ISF-TG5
Range (N)	0.01~0.1	0.03~0.3	0.05~0.5	0.1~1	0.15~1.5	0.3~3	0.5~5
Graduation (N)	0.002	0.005	0.01	0.02	0.025	0.05	0.1
Accuracy	±2% (full scale)						
Dimension (L×W×H)	90×47×19mm						
Weight	60g						

SPECIFICATION (Unit: gf)

Code	ISF-TG10	ISF-TG30	ISF-TG50	ISF-TG100	ISF-TG150	ISF-TG300	ISF-TG500
Range (gf)	1~10	3~30	5~50	10~100	15~150	30~300	50~500
Graduation (gf)	0.2	0.5	1	2	2.5	5	10
Accuracy	±2% (full scale)						
Dimension (L×W×H)	90×47×19mm						
Weight	60g						

ATTENTION: NOT SUITABLE FOR ELECTRIC WRENCHES, IMPACT WRENCHES OR PNEUMATIC WRENCHES

DIGITAL TORQUE TESTERS

- With external sensor, to test torque wrenches, torque screwdrivers and other torque tools
- Clockwise and counter-clockwise operation
- Peak, track and first peak working modes
- Unit: N.m, in.lb, ft.lb, kg.cm
- Tolerance testing
- LED indicator for the target torque alarm:
 - Yellow LED light on when the value is below the low tolerance; green LED light on when the value is within tolerance; red LED light on when the value is above the high tolerance
 - The buzzer alarms when the maximum torque value is captured in the first peak mode
- Automatic power off



IST-TT550

STANDARD DELIVERY

Main unit	1 pc
Transducer with 1.5m cable	1 pc
Extension cable (1.2m)	1 pc
AC/DC adapter	1 pc
Adaptor	see details



extension cable (included)



adaptor (included)



with 3 mounting holes on the bottom

SPECIFICATION

Code	IST-TT05	IST-TT5	IST-TT30	IST-TT50	IST-TT220	IST-TT550	IST-TT1000	IST-TT2200
Range	0.1~0.5N.m	0.5~5N.m	3~30N.m	5~50N.m	22~220N.m	55~550N.m	100~1000N.m	220~2200N.m
Accuracy	±1% (clockwise and counter-clockwise)							
Resolution	0.0001N.m	0.0001N.m	0.001N.m	0.001N.m	0.01N.m	0.01N.m	0.1N.m	0.1N.m
Square socket (L)	1/4"	1/4"	3/8"	3/8"	1/2"	3/4"	1"	1"
Power supply	DC							
Adaptor	no	no	3/8" to 1/4"	3/8" to 1/4"	1/2" to 3/8" 3/8" to 1/4"	3/4" to 1/2" 1/2" to 3/8"	1" to 3/4" 3/4" to 1/2" 1/2" to 3/8"	1" to 3/4" 3/4" to 1/2"
Transducer dimension	63×63 ×65mm	63×63 ×65mm	89×89 ×75mm	89×89 ×75mm	109×109 ×83mm	140×140 ×107mm	160×160 ×126mm	160×160 ×126mm
Weight	0.75kg	0.75kg	1.1kg	1.1kg	1.4kg	2.9kg	5.0kg	5.1kg

TORQUE WRENCH TEST STAND CODE IST-TS500



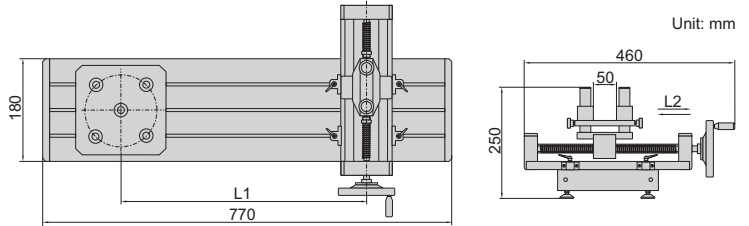
application example



digital torque tester (optional)



adaptor (optional, for digital torque tester IST-TT5, IST-TT30, IST-TT50, IST-TT220)



- Work with digital torque testers (IST-TT5, IST-TT30, IST-TT50, IST-TT220, IST-TT550)

SPECIFICATION

Digital torque tester	IST-TT5 (optional)	IST-TT30 (optional)	IST-TT50 (optional)	IST-TT220 (optional)	IST-TT550 (optional)
Applicable torque wrenches	0.5~5N.m	3~30N.m	5~50N.m	22~220N.m	220~340N.m
Arm length (L1)	150~620mm, adjustable				
Maximum travel (L2)	200mm				
Weight	12.78kg				

OPTIONAL ACCESSORY

Digital torque tester	IST-TT5, IST-TT30, IST-TT50, IST-TT220, IST-TT550
Adaptor	IST-TS500-BLOCK (necessary for IST-TT5, IST-TT30, IST-TT50 and IST-TT220, not needed for IST-TT550)

DIGITAL TORQUE TESTERS



printer (optional)



software CD (included)

- External sensor
- Metal case, touch buttons
- Clockwise and counter-clockwise operation
- Test mode: track, peak, first peak, preset tolerance
- Unit: N.m, N.cm, kgf.cm, lbf.in, lbf.ft
- Set tolerance with judgement
- 1000 memories
- LCD display with backlight, can automatically turn 180°
- Overload alarm
- Automatic power off



IST-DTT5



DATA OUTPUT

two display modes



SPECIFICATION

Code	IST-DTT1	IST-DTT5	IST-DTT10
Load capacity	1N.m	5N.m	10N.m
Resolution	0.001N.m	0.001N.m	0.01N.m
Max. clamping diameter	Ø10mm	Ø10mm	Ø13mm
Sampling frequency	2000 times per second		
Accuracy	±0.3% (of load capacity)		
Output	USB, RS232, alarm signal		
Power supply	built-in rechargeable battery		
Dimension	145x73x34mm		
Weight	1.4kg		

STANDARD DELIVERY

Main unit	1 pc
External sensor	1 pc
AC/DC adapter	1 pc
Software and USB cable	1 pc

OPTIONAL ACCESSORY

Printer	ISF-DF-PRINTER
RS232 cable	IST-DTT-CABLE



DATA
OUTPUT

DIGITAL BOTTLE CAP TORQUE TESTERS



software CD
(included)



printer (optional)

- Measure the opening and tightening torque of bottle caps
- Unit: N.m, N.cm, kgf.cm, lbf.in, lbf.ft
- 1500 memories
- Wireless connection to printer
- Automatic power off
- LCD display with backlight
- Overload alarm
- With calibration function



IST-DCT20

two display modes



digit mode



graph mode

SPECIFICATION

Code	IST-DCT2	IST-DCT5	IST-DCT10	IST-DCT20
Load capacity	2N.m	5N.m	10N.m	20N.m
Resolution	0.001N.m	0.001N.m	0.01N.m	0.01N.m
Clamping range	Ø19.5~190mm			
Accuracy	±0.5% (of load capacity)			
Measuring mode	tracking, peak (max.), first peak, double peak, tolerance testing			
Output	wireless and USB			
Power supply	built-in rechargeable battery			
Dimension	200×197×142mm			
Weight	2.5kg			

STANDARD DELIVERY

Main unit	1 pc
AC/DC adapter	1 pc
Software and USB cable	1 pc

OPTIONAL ACCESSORY

Printer	ISH-DS-PRINTER
---------	----------------

DIAL TORQUE SCREWDRIVERS



IST-DS2

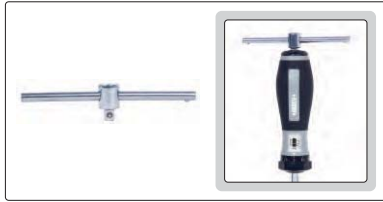
- Clockwise and counter-clockwise operation
- With peak value indicator

SPECIFICATION

Code	IST-DS02	IST-DS05	IST-DS1	IST-DS2	IST-DS5
Range	0.05~0.2N.m	0.1~0.5N.m	0.2~1N.m	0.5~2N.m	1~5N.m
Graduation	0.005N.m	0.01N.m	0.02N.m	0.05N.m	0.1N.m
Head	1/4" hex socket				
Accuracy	±6%				
Length	152mm	273mm	273mm	273mm	273mm
Weight	170g	400g	400g	400g	400g

TORQUE SCREWDRIVERS

ATTENTION: CLOCKWISE OPERATION ONLY



T-bar wrench (only for IST-MG250, IST-MG360, IST-MG600)



IST-MG600

SPECIFICATION

Code	IST-MG50	IST-MG100	IST-MG250	IST-MG360	IST-MG600
Range (clockwise)	10~50cN.m	20~100cN.m	50~250cN.m	60~360cN.m	1.0~6.0N.m
Graduation	1cN.m	2cN.m	5cN.m	5cN.m	0.1N.m
Head	1/4" hex socket				
Accuracy	±6%				
Length	172mm				
Weight	0.26kg				

STANDARD DELIVERY

Torque screwdriver	1 pc
T-bar wrench (only for IST-MG250, IST-MG360, IST-MG600)	1 pc

DIGITAL TORQUE SCREWDRIVERS

INSPECTION CERTIFICATE



- Clockwise and counter-clockwise operation
- Unit: cN.m, in.lb, kg.cm
- Peak and track working modes
- Target torque value can be set, with audible and visible alarm:
 - Green LED light on and buzzer sounds when target torque value is 90%~100% of target torque
 - Red LED light on and buzzer sounds when target torque value is reached
- Power off automatically in 5 minutes without any operations



IST-SD200

SPECIFICATION

Code	IST-SD50	IST-SD200	IST-SD400
Range	10~50cN.m	40~200cN.m	80~400cN.m
Accuracy	clockwise	±3%	±2.5%
	counter-clockwise	±4%	±3.5%
Resolution	0.1cN.m	0.1cN.m	0.1cN.m
Size of hex socket (L)	1/4"	1/4"	1/4"
Power supply	1×AAA battery		
Length	193mm	203mm	203mm
Weight	190g	200g	200g

OPTIONAL ACCESSORY

Calibration cable	IST-SD-CABLE
-------------------	--------------



SMALL RANGE DIGITAL TORQUE WRENCHES

- Clockwise and counter-clockwise operation
- Unit: N.m, in.lb, ft.lb, kg.cm
- Peak and track working modes
- Target torque value can be set, with audible and visible alarm:
 - Green LED light on and buzzer sounds when target torque value is 90%~100% of target torque
 - Red LED light on and buzzer sounds when target torque value is reached
- Power off automatically in 5 minutes without any operations
- Non-slip grip handle
- With overload record (once the torque reaches 110% of the maximum range)



IST-WP20

SPECIFICATION

Code	IST-WP6	IST-WP12	IST-WP20
Range	1.2~6N.m	2.4~12N.m	4~20N.m
Accuracy	clockwise	±3%	±3%
	counter-clockwise	±4%	±4%
Resolution	0.001N.m	0.01N.m	0.01N.m
Square driver (L)	1/4"	1/4"	1/4"
Power supply	1×AAA battery		
Length	260mm	260mm	260mm
Weight	430g	430g	430g

OPTIONAL ACCESSORY

Calibration cable	IST-SD-CABLE
-------------------	--------------

OPTIONAL ACCURACY:
CLOCKWISE: ±1%
COUNTER-CLOCKWISE: ±2%
ONLY FOR RANGE 6~850N.m



DIGITAL TORQUE WRENCHES

- Clockwise and counter-clockwise operation
- Unit: N.m, in.lb, ft.lb, kg.cm
- Peak and track working modes
- Target torque value can be set, with audible and visible alarm:
 - Green LED light on and buzzer sounds when torque value is 90%~100% of target torque
 - Both green and red LED light on and buzzer sounds when target torque value is reached
- Power off automatically in 5 minutes without any operations
- Non-slip grip handle
- With damp record
- With overload record (once the torque reaches 110% of the maximum range)



IST-W135A

SPECIFICATION

Code	Range	Accuracy	Resolution	Square driver (L)	Power supply	Length	Weight
IST-W30A	6~30N.m	clockwise: ±2% counter-clockwise: ±3%	0.01N.m	1/4"	2×AA batteries	390mm	830g
IST-W135A	27~135N.m		0.1N.m	3/8"		415mm	950g
IST-W200A	40~200N.m		0.1N.m	1/2"		530mm	1.4kg
IST-W340A	68~340N.m	clockwise: ±2.5% counter-clockwise: ±3.5%	0.1N.m	1/2"		650mm	1.6kg
IST-W500A	100~500N.m		0.1N.m	3/4"		950mm	2.1kg
IST-W850A	170~850N.m		0.1N.m	3/4"		1220mm	2.55kg
IST-W1200A	240~1200N.m	clockwise: ±2.5% counter-clockwise: ±3.5%	1N.m	1"		1800mm	13kg
IST-W1500A	300~1500N.m		1N.m	1"		1800mm	13kg
IST-W2000A	400~2000N.m		1N.m	1"		1800mm	14kg

OPTIONAL ACCESSORY

Calibration cable	IST-W-CABLE
-------------------	-------------

SHORT HANDLE DIGITAL TORQUE WRENCHES



- Clockwise and counter-clockwise operation
- Unit: N.m, in.lb, ft.lb, kg.cm
- Peak and track working modes
- Target torque value can be set, with audible and visible alarm:
 - Green LED light on and buzzer sounds when torque value is 90%~100% of target torque
 - Both green and red LED light on and buzzer sounds when target torque value is reached
- Power off in 5 minutes automatically
- Non-slip grip handle
- With damp record
- With overload record (once the torque reaches 110% of the maximum range)



IST-WS60



SPECIFICATION

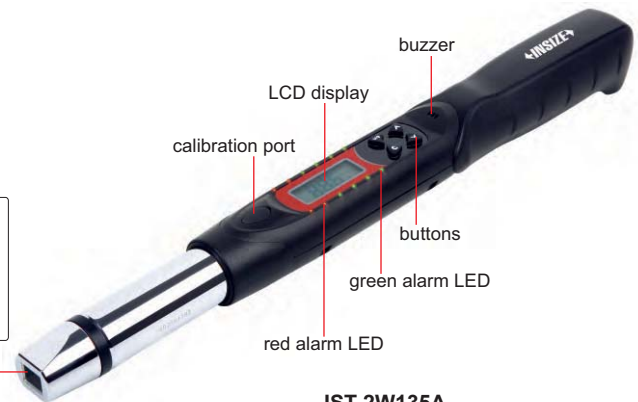
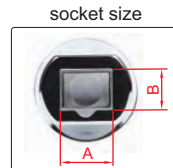
Code	IST-WS30	IST-WS30A	IST-WS60	IST-WS85
Range	6~30N.m	6~30N.m	12~60N.m	17~85N.m
Accuracy	clockwise	±3%		
	counter-clockwise	±4%		
Resolution	0.01N.m	0.01N.m	0.01N.m	0.1N.m
Square driver (L)	1/4"	3/8"	3/8"	3/8"
Power supply	2×AAA batteries			
Length	215mm	215mm	225mm	271mm
Weight	750g	830g	917g	1000g

OPTIONAL ACCESSORY

Calibration cable	IST-SD-CABLE
-------------------	--------------

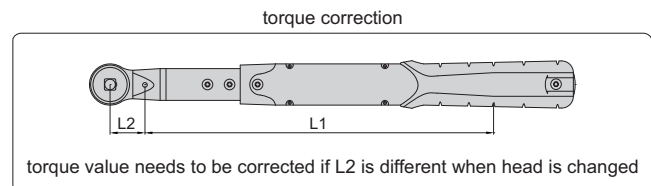
INTERCHANGEABLE HEAD DIGITAL TORQUE WRENCHES

OPTIONAL ACCURACY:
CLOCKWISE: ±1%
COUNTER-CLOCKWISE: ±2%



IST-2W135A

- Clockwise and counter-clockwise operation
- Unit: N.m, in.lb, ft.lb, kg.cm, degree
- Peak and track working modes
- Target torque value can be set, with audible and visible alarm:
 - Green LED light on and buzzer sounds when torque value is 90%~100% of target torque
 - Both green and red LED light on and buzzer sounds when target torque value is reached
- Power off in 5 minutes automatically without any operations
- Non-slip grip handle
- With damp record
- With overload record (once the torque reaches 110% of the maximum range)



SPECIFICATION

Code	IST-2W30A	IST-2W135A	IST-2W200A	IST-2W340A	IST-2W410A
Range	6~30N.m	27~135N.m	40~200N.m	68~340N.m	82~410N.m
Accuracy	clockwise	±2%			
	counter-clockwise	±3%			
Resolution	0.01N.m	0.1N.m	0.1N.m	0.1N.m	0.1N.m
Socket size (A×B)	12×9mm	12×9mm	18×14mm	18×14mm	18×14mm
Arm length (L1)	272.7mm	287.7mm	381.2mm	501.2mm	501.2mm
Power supply	2xAA batteries, for 110 hours working				
Weight	1400g	1570g	2170g	2320g	2320g

To be continued

Continued from previous page

RATCHET HEAD (INCLUDED) SPECIFICATION

Code of torque wrench	IST-2W30A	IST-2W135A	IST-2W200A	IST-2W340A	IST-2W410A
Square driver (D)	1/4"	3/8"	1/2"	1/2"	3/4"
Length (L2)	29mm	29mm	40mm	40mm	40mm

STANDARD DELIVERY

Torque wrench	1 pc
Ratchet head	1 pc

OPTIONAL ACCESSORY

Calibration cable	IST-W-CABLE
Interchangeable head	see details



RATCHET HEAD (optional)

Code	Square driver (D)	Applicable wrenches
IST-2W-R1	1/4"	IST-2W30A
IST-2W-R2	3/8"	IST-2W135A
IST-2W-R3	1/2"	IST-2W135A
IST-2W-R4	1/2"	IST-2W200A IST-2W340A IST-2W410A

ADJUSTABLE SPANNER HEAD (optional)

Code	Open size	Applicable wrenches
IST-2W-A1	5~27mm	IST-2W135A
IST-2W-A2	5-30mm	IST-2W-200A IST-2W-410A
IST-2W-A3	10-41mm	IST-2W-340A IST-2W-410A



OPEN END HEAD (optional)

Code	Open size	Applicable wrenches	
IST-2W-K7	7mm	IST-2W30A IST-2W135A	
IST-2W-K8	8mm		
IST-2W-K9	9mm		
IST-2W-K10	10mm		
IST-2W-K11	11mm		
IST-2W-K12	12mm		
IST-2W-K13	13mm		
IST-2W-K14	14mm		
IST-2W-K15	15mm		
IST-2W-K16	16mm		
IST-2W-K17	17mm		
IST-2W-K18	18mm		
IST-2W-K19	19mm		
IST-2W-K13A	13mm		IST-2W200A IST-2W340A IST-2W410A
IST-2W-K14A	14mm		
IST-2W-K15A	15mm		
IST-2W-K16A	16mm		
IST-2W-K17A	17mm		
IST-2W-K18A	18mm		
IST-2W-K19A	19mm		
IST-2W-K21A	21mm		
IST-2W-K22A	22mm		
IST-2W-K24A	24mm		
IST-2W-K27A	27mm		

BOX END HEAD (optional)

Code	Open size	Applicable wrenches	
IST-2W-M7	7mm	IST-2W30A IST-2W135A	
IST-2W-M8	8mm		
IST-2W-M10	10mm		
IST-2W-M11	11mm		
IST-2W-M12	12mm		
IST-2W-M13	13mm		
IST-2W-M14	14mm		
IST-2W-M15	15mm		
IST-2W-M16	16mm		
IST-2W-M17	17mm		
IST-2W-M18	18mm		
IST-2W-M19	19mm		
IST-2W-M21	21mm		
IST-2W-M22	22mm		IST-2W200A IST-2W340A
IST-2W-M13A	13mm		
IST-2W-M14A	14mm		
IST-2W-M15A	15mm		
IST-2W-M16A	16mm		
IST-2W-M17A	17mm		
IST-2W-M18A	18mm		
IST-2W-M19A	19mm		
IST-2W-M21A	21mm		

BLUETOOTH DIGITAL TORQUE WRENCHES (KEYBOARD SIGNAL)

OPTIONAL ACCURACY:
CLOCKWISE: $\pm 1\%$
COUNTER-CLOCKWISE: $\pm 2\%$

BUILT-IN BLUETOOTH

INSPECTION
CERTIFICATE



Torque wrenches:

- Unit: in.lb, ft.lb, N.m, kg.cm
- Clockwise and counter-clockwise operation
- Peak and track working mode
- Can set tolerance with judgement in peak working mode
- 9 target torque values can be set, with audible and visible alarm:
LED lights up in sequence, and the buzzer gets louder and louder when torque value is 80%~99.5% of target torque
- Memory of 2000 results
- Power off in 2 minutes automatically
- Non-slip grip handle
- With overload record (once the torque reaches 110% of the maximum range)

Data transmission:

- Built-in Bluetooth 4.0 module, which can be connected with computers (with Bluetooth function), mobile phones, tablets and other devices
- Keyboard signal, can be transmitted to Excel, Word, Txt
- Transmission distance is 10 meters (no obstacles, no electromagnetic interference)
- Bluetooth connection and disconnection are respectively shown by indicator lights



transmission distance is 10 meters
(no obstacles, no electromagnetic interference)

SPECIFICATION

Code	IST-15W30A	IST-15W135A	IST-15W200A	IST-15W340A
Range	6~30N.m	27~135N.m	40~200N.m	68~340N.m
Accuracy	clockwise	$\pm 2\%$		
	counter-clockwise	$\pm 3\%$		
Tolerance setting range	-20%~+20% (target torque value)			
Resolution	0.01N.m	0.1N.m	0.1N.m	0.1N.m
Square driver (L)	1/4"	3/8"	1/2"	1/2"
Power supply	2xAA batteries			
Length	390mm	415mm	530mm	650mm
Weight	760g	940g	1340g	1540g

OPTIONAL ACCESSORY

Calibration cable	IST-SD-CABLE
-------------------	--------------

ATTENTION: CLOCKWISE
OPERATION ONLY

INTERCHANGEABLE HEAD TORQUE WRENCHES

**INSPECTION
CERTIFICATE**



IST-11WM200

- According to DIN ISO 6789, ASME B107.300
- All-metal construction, sturdy and durable

SPECIFICATION

Code	Range (clockwise)	Accuracy	Graduation	Socket size (A×B)	Length	Weight
IST-11WM12	2.5~12N.m	±6% (<10N.m) ±4% (≥10N.m)	0.05N.m	12×9mm	284mm	580g
IST-11WM30	6.0~30N.m	±6% (<10N.m) ±4% (≥10N.m)	0.1N.m	12×9mm	303mm	720g
IST-11WM60	10~60N.m	±4%	0.5N.m	12×9mm	372mm	860g
IST-11WM125	25~125N.m	±4%	0.5N.m	12×9mm	427mm	940g
IST-11WM200	40~200N.m	±4%	1N.m	18×14mm	460mm	1060g
IST-11WM335	65~335N.m	±4%	1N.m	18×14mm	520mm	1200g

RATCHET HEAD (optional)

Code	Square driver	Applicable wrenches
IST-11WM-R1	1/4"	IST-11WM12 IST-11WM30
IST-11WM-R2	3/8"	IST-11WM12 IST-11WM30 IST-11WM60 IST-11WM125
IST-11WM-R3	1/2"	IST-11WM200 IST-11WM335
IST-11WM-R4*	3/4"	IST-11WM200 IST-11WM335



OPEN END HEAD (optional)

Code	Open size	Applicable wrenches
IST-11WM-K8	8mm	IST-11WM12 IST-11WM30 IST-11WM60 IST-11WM125
IST-11WM-K10	10mm	
IST-11WM-K13	13mm	
IST-11WM-K14	14mm	
IST-11WM-K15	15mm	
IST-11WM-K17	17mm	
IST-11WM-K19*	19mm	
IST-11WM-K13A	13mm	IST-11WM200 IST-11WM335
IST-11WM-K14A	14mm	
IST-11WM-K15A	15mm	
IST-11WM-K17A	17mm	
IST-11WM-K19A	19mm	
IST-11WM-K22A	22mm	
IST-11WM-K24A	24mm	
IST-11WM-K27A*	27mm	
IST-11WM-K30A*	30mm	
IST-11WM-K32A*	32mm	

BOX END HEAD (optional)

Code	Open size	Applicable wrenches
IST-11WM-M8	8mm	IST-11WM12 IST-11WM30 IST-11WM60 IST-11WM125
IST-11WM-M10	10mm	
IST-11WM-M13	13mm	
IST-11WM-M14	14mm	
IST-11WM-M15	15mm	
IST-11WM-M17	17mm	
IST-11WM-M19	19mm	
IST-11WM-M13A	13mm	IST-11WM200 IST-11WM335
IST-11WM-M14A	14mm	
IST-11WM-M15A	15mm	
IST-11WM-M17A	17mm	
IST-11WM-M19A	19mm	
IST-11WM-M22A	22mm	
IST-11WM-M24A	24mm	
IST-11WM-M27A	27mm	
IST-11WM-M30A	30mm	
IST-11WM-M32A	32mm	

* Torque value needs to be corrected with those heads

TORQUE WRENCHES



ATTENTION: CLOCKWISE OPERATION ONLY

- According to DIN ISO 6789, ASME B107.300
- All-metal construction, sturdy and durable



IST-9WM335

SPECIFICATION

Code	IST-9WM12	IST-9WM20	IST-9WM30	IST-9WM60	IST-9WM100	IST-9WM125	IST-9WM200
Range (clockwise)	2.5~12N.m	4~20N.m	6~30N.m	10~60N.m	20~100N.m	25~125N.m	40~200N.m
Accuracy	±6% (<10N.m) ±4% (≥10N.m)	±6% (<10N.m) ±4% (≥10N.m)	±6% (<10N.m) ±4% (≥10N.m)	±4%	±4%	±4%	±4%
Graduation	0.1N.m	0.1N.m	0.2N.m	0.5N.m	0.5N.m	0.5N.m	1N.m
Square driver (D)	1/4"	1/4"	3/8"	3/8"	1/2"	1/2"	1/2"
Length	290mm	290mm	318mm	388mm	443mm	443mm	468mm
Weight	680g	680g	820g	960g	1040g	1040g	1160g

Code	IST-9WM335	IST-9WM500	IST-9WM800	IST-9WM1000	IST-9WM1500	IST-9WM2000	IST-9WM3000
Range (clockwise)	65~335N.m	100~500N.m	160~800N.m	200~1000N.m	300~1500N.m	400~2000N.m	600~3000N.m
Accuracy	±4%	±4%	±4%	±4%	±4%	±4%	±4%
Graduation	1N.m	2.5N.m	4N.m	5N.m	5N.m	10N.m	15N.m
Square driver (D)	1/2"	3/4"	3/4"	3/4"	1"	1"	1"
Length	528mm	855mm	1055mm	1055mm	1260mm	1260mm	1260mm
Weight	1300g	5000g	5900g	5900g	9200g	9200g	10500g

PRESET TORQUE WRENCHES

ATTENTION: CLOCKWISE OPERATION ONLY

- Torque is preset, to prevent adjustment by mistake during use
- The torque is set at the factory before delivery. Customers can also set the torque with torque adjustment tool (IST-PW-TOOL, optional) and digital torque testers (IST-TT□□□, optional)
- Clockwise operation only



IST-PW60



torque adjustment tool (optional)

SPECIFICATION

Code	IST-PW12	IST-PW20	IST-PW30	IST-PW60	IST-PW125	IST-PW200
Adjustable range *	2.5~12N.m	4~20N.m	6~30N.m	10~60N.m	25~125N.m	40~200N.m
Accuracy	±3%	±3%	±3%	±3%	±3%	±3%
Square driver (D)	1/4"	1/4"	3/8"	3/8"	3/8"	1/2"
Length	184mm	184mm	214mm	255mm	366mm	457mm
Weight	450g	450g	500g	560g	790g	1200g

Code	IST-PW340	IST-PW500	IST-PW650	IST-PW800	IST-PW1000A	IST-PW1000B
Adjustable range *	65~340N.m	100~500N.m	150~650N.m	160~800N.m	200~1000N.m	200~1000N.m
Accuracy	±3%	±3%	±4%	±4%	±4%	±4%
Square driver (D)	1/2"	3/4"	3/4"	3/4"	3/4"	1"
Length	691mm	910mm	910mm	1037mm	1265mm	1265mm
Weight	1960g	2800g	2800g	5000g	6000g	6000g

OPTIONAL ACCESSORY

Torque adjustment tool	IST-PW-TOOL
------------------------	-------------

* Adjust to a fixed torque value according to customer requirements before delivery



DIAL TORQUE WRENCHES

- Clockwise and counter-clockwise operation
- According to DIN ISO 6789, ASME B107.300



IST-DW70

SPECIFICATION

Code	IST-DW3D5	IST-DW9	IST-DW18	IST-DW35	IST-DW70	IST-DW140	IST-DW240	IST-DW350
Range	0.7~3.5N.m 6~30in.lb	1.8~9N.m 15~75in.lb	3.6~18N.m 30~150in.lb	7~35N.m 60~300in.lb	14~70N.m 120~600in.lb	28~140N.m 20~100ft.lb	48~240N.m 35~175ft.lb	70~350N.m 50~250ft.lb
Accuracy	±3%	±3%	±3%	±3%	±3%	±3%	±3%	±3%
Graduation	0.05N.m 0.5in.lb	0.1N.m 1in.lb	0.2N.m 2in.lb	0.5N.m 5in.lb	1N.m 10in.lb	2N.m 1ft.lb	3N.m 2.5ft.lb	2.5N.m 2.5ft.lb
Square driver (D)	1/4"	1/4"	3/8"	3/8"	3/8"	1/2"	1/2"	1/2"
Length	254mm	254mm	254mm	254mm	378mm	546mm	546mm	546mm
Weight	480g	480g	480g	480g	820g	1300g	1300g	1300g



DIGITAL TORQUE ADAPTERS (WITH ANGLE DETECTION)

- Clockwise and counter-clockwise operation
- After reaching the desired torque, turn the wrench at an angle to apply extra torque
- Unit: N.m, in.lb, ft.lb, kg.cm, degree
- Peak and track working modes
- Target torque or angle value can be set, with audible and visible alarm:
 - Green LED light on and buzzer sounds when torque or angle value is 80%~100% of target torque or angle
 - Both green and red LED light on and buzzer sounds when target torque or angle value is reached
- Power off in 2 minutes automatically
- Memory 50 measurement values for browsing
- With overload record (once the torque reaches 110% of the maximum range)



IST-5W135A

SPECIFICATION

Code	IST-5W30A	IST-5W135A	IST-5W200A	IST-5W340A
Range	torque	6~30N.m	27~135N.m	40~200N.m
	angle	0~999°		
Accuracy	clockwise	±3%		
	counter-clockwise	±4%		
	angle	±2° (rotate at 90°)		
Resolution	torque	0.01N.m	0.1N.m	0.1N.m
	angle	1°		
Square driver (L)	1/4"	3/8"	1/2"	1/2"
Power supply	2xAAA batteries			
Length	Ø85×60mm	Ø85×75mm	Ø85×80mm	Ø85×80mm
Weight	150g	220g	240g	240g

working with mechanical wrenches



OPTIONAL ACCESSORY

Calibration cable	IST-SD-CABLE
-------------------	--------------

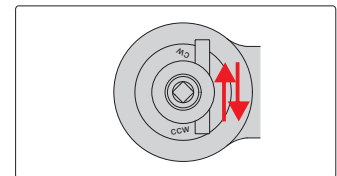
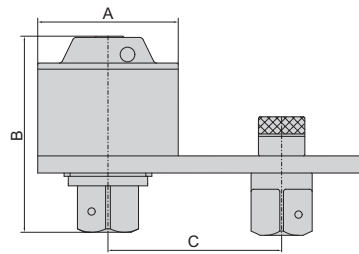
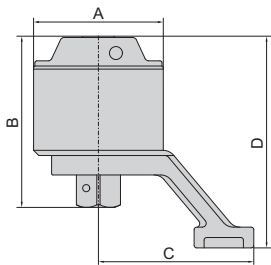
TORQUE MULTIPLIERS



IST-TM2000



IST-TM3500P



■ Input to output accuracy: $\pm 5\%$

After tightening, toggle the anti-bounce reversing dowel, turn the wrench in the anticlockwise direction, then remove the wrench from torque multiplier

Z TYPE (BEVEL TYPE) TORQUE MULTIPLIER

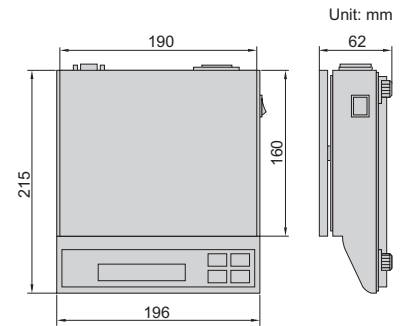
Code	Capacity	Torque ratio	Square socket	Square driver	Dimension (A×B×C×D)	For bolt	For nut	Weight
IST-TM1000	1000N.m	1:4	1/2"	1"	82x98.5x97x122.4mm	M20~30	S30~46	2.1kg
IST-TM2000	2000N.m	1:13	1/2"	1"	82x120x105x147mm	M22~35	S32~55	3.15kg
IST-TM3500	3500N.m	1:16	1/2"	1"	98x131x120x163mm	M30~45	S46~70	4.9kg
IST-TM5500	5500N.m	1:20.5	1/2"	1 1/2"	115x163.5x137x199mm	M38~52	S55~80	8.1kg
IST-TM7500	7500N.m	1:23	1/2"	1 1/2"	127x173x146x215mm	M42~60	S65~90	10.6kg
IST-TM10000	10000N.m	1:28	1/2"	1 1/2"	141x170x164x238mm	M52~72	S80~105	14kg

L TYPE (PLATE TYPE) TORQUE MULTIPLIER

Code	Capacity	Torque ratio	Square socket	Square driver	Dimension (A×B×C)	For bolt	For nut	Weight
IST-TM1000P	1000N.m	1:4	1/2"	1"	82x91x (76.7~127.3)mm	M20~30	S30~46	2.4kg
IST-TM2000P	2000N.m	1:13	1/2"	1"	82x120x (92.7~129.3)mm	M22~35	S32~55	3.5kg
IST-TM3500P	3500N.m	1:16	1/2"	1"	98x128x (102.7~145.3)mm	M30~45	S46~70	5.0kg
IST-TM5500P	5500N.m	1:20.5	1/2"	1 1/2"	115x157x (134.05~165.95)mm	M38~52	S55~80	8.7kg
IST-TM7500P	7500N.m	1:23	1/2"	1 1/2"	127x168x (139.05~190.95)mm	M42~60	S65~90	11.7kg
IST-TM10000P	10000N.m	1:28	1/2"	1 1/2"	141x186x (144.05~215.95)mm	M52~72	S80~105	15.2kg
IST-TM15000P	15000N.m	1:50	3/4"	2 1/2"	156x246x (155.25~244.75)mm	M60~85	S80~120	24.1kg
IST-TM20000P	20000N.m	1:76	3/4"	2 1/2"	170x264x (163.75~276.25)mm	M72~100	S105~145	27.8kg

DATA
OUTPUT

ELECTRONIC BALANCES



- Automatic zero when power on
- Unit: g (gram), ct (carat), ozt (troy ounce)
- Weighing, counting, taring
- Overload alarm
- Data output

8301-3000

Code	8301-300	8301-600	8301-1200	8301-3000	8301-6000
Maximum weighing	300g	600g	1200g	3000g	6000g
Minimum weighing	0.2g	0.2g	0.2g	2g	2g
Resolution	0.01g	0.01g	0.01g	0.1g	0.1g
Weighing pan size	Ø135mm			190×160mm	
Verification scale interval	10d				
Working temperature	0~40°C				
Working humidity	≤80% RH				
Power supply	power adapter				
Dimension (L×W×H)	215×196×62mm				



calibration weight
(included in 8301-300,
8301-600 and 8301-1200)



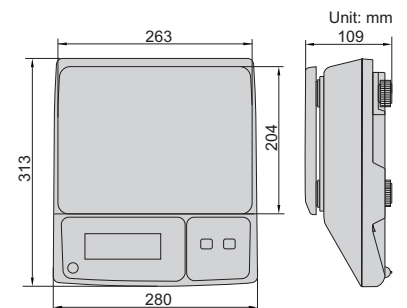
windshield
(included in 8301-300,
8301-600 and 8301-1200)

OPTIONAL ACCESSORY

RS232 CABLE	8301-CABLE
-------------	------------



WEIGHING SCALES (OIML CERTIFICATE)



- LCD display, with backlight
- Zero-setting, subtracting tare value
- Overload alarm
- Automatic power off
- OIML certificate (No. 0200-NAWI-04601)

8002-30M

SPECIFICATION

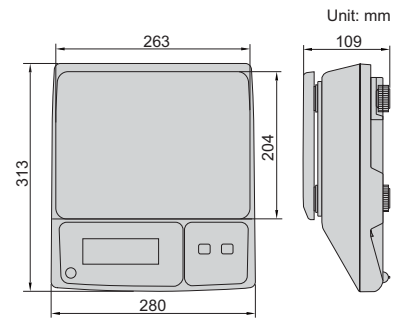
Code	8002-6M	8002-15M	8002-30M	8002-6MD	8002-15MD	8002-30MD
Maximum capacity	3/6kg	6/15kg	15/30kg	3/6kg	6/15kg	15/30kg
Minimum capacity	20g	40g	100g	20g	40g	100g
Division	1/2g	2/5g	5/10g	1/2g	2/5g	5/10g
Verification interval	2g	5g	10g	2g	5g	10g
Output	no			RS232		
Operating temperature	-10~40°C					
Power	rechargeable battery (6V/3.2Ah), power adapter (12V/500mA)					
Dimensions of pan	263×204mm					

WEIGHING SCALES (HIGH PRECISION)

- LCD display, with backlight
- Zero-setting, subtracting tare value
- Overload alarm
- Automatic power off



8001-30



SPECIFICATION

Code	8001-6	8001-15	8001-30	8001-6D	8001-15D	8001-30D
Maximum capacity	6kg	15kg	30kg	6kg	15kg	30kg
Minimum capacity	4g	10g	20g	4g	10g	20g
Division	0.2g	0.5g	1g	0.2g	0.5g	1g
Verification interval	2g	5g	10g	2g	5g	10g
Output	no			RS232		
Operating temperature	-10~40°C					
Power	rechargeable battery (6V/3.2Ah), power adapter (12V/500mA)					
Dimensions of pan	263×204mm					



printer (optional)

OPTIONAL ACCESSORY (for scales with RS232)

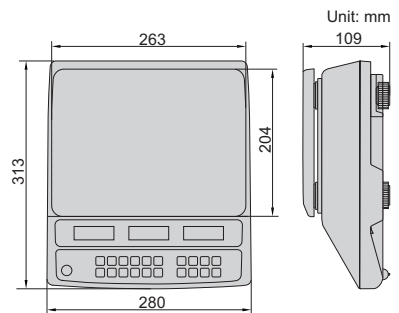
Printer	8001-PRINTER
---------	--------------

COUNTING SCALES

- LCD display, with backlight
- Zero-setting, subtracting tare value, counting, accumulation, checking alarm
- Overload alarm



8101-30



SPECIFICATION

Code	8101-6	8101-15	8101-30	8101-6D	8101-15D	8101-30D
Maximum capacity	6kg	15kg	30kg	6kg	15kg	30kg
Minimum capacity	4g	10g	20g	4g	10g	20g
Division	0.2g	0.5g	1g	0.2g	0.5g	1g
Verification interval	2g	5g	10g	2g	5g	10g
Output	no			RS232		
Operating temperature	-10~40°C					
Power	rechargeable battery (6V/3.2Ah), power adapter (12V/500mA)					
Dimensions of pan	263×204mm					



printer (optional)

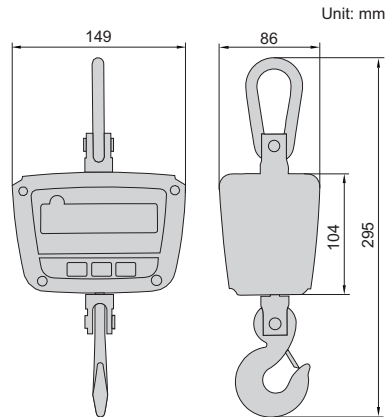
OPTIONAL ACCESSORY (for scales with RS232)

Printer	8001-PRINTER
---------	--------------

IP65
WATERPROOF

ELECTRONIC CRANE SCALES

- Dust/waterproof level: IP65
- LED display, remote control
- Low voltage indicator
- Unit: kg, lb
- Automatic power off
- Overload alarm
- 360° safe rotary hook and shackle
- Aluminum alloy die casting case with high strength



Remote controller (included)



8201-150KG

SPECIFICATION

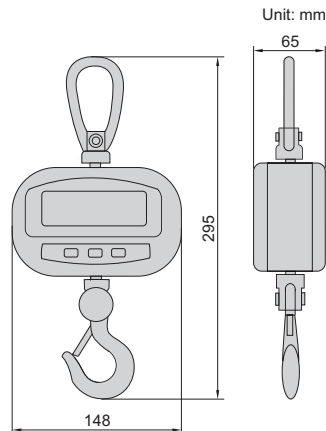
Code	8201-50KG	8201-150KG	8201-300KG
Maximum capacity	50kg	150kg	300kg
Minimum capacity	0.4kg	1.0kg	2.0kg
Resolution	0.02kg/0.01kg	0.05kg/0.02kg	0.10kg/0.05kg
Operating temperature	-10~40°C		
Operating humidity	30%~90% RH		
Overload alarm	100%F.S.+9e		
Maximum safe load	125%F.S.		
Limited overload	400%F.S.		
Power supply	rechargeable battery 6V/3Ah (for 40 hours working)		
Stable reading time	≤8s		

STANDARD DELIVERY

Main unit	1 pc
Remote controller	1 pc
Battery charger	1 pc

ELECTRONIC CRANE SCALES (ECONOMIC TYPE)

- LED display, remote control
- Low voltage indicator
- Unit: kg, lb
- Automatic power off
- Overload alarm
- 360° safe rotary hook and shackle
- Plastic case



Remote controller (included)



8202-150KG

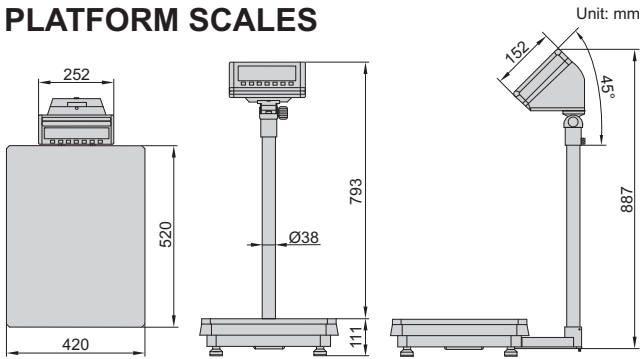
SPECIFICATION

Code	8202-50KG	8202-150KG	8202-300KG
Maximum capacity	50kg	150kg	300kg
Minimum capacity	0.4kg	1.0kg	2.0kg
Resolution	0.02kg/0.01kg	0.05kg/0.02kg	0.10kg/0.05kg
Operating temperature	-10~40°C		
Operating humidity	30%~90% RH		
Overload alarm	100%F.S.+9e		
Maximum safe load	125%F.S.		
Limited overload	400%F.S.		
Power supply	4×1.5V AA batteries (for 40 hours working)		
Stable reading time	≤8s		

STANDARD DELIVERY

Main unit	1 pc
Remote controller	1 pc

PLATFORM SCALES



SPECIFICATION

Code	8501-AL60	8501-AL150	8501-AL300
Maximum capacity	60kg	150kg	300kg
Minimum capacity	100g	200g	400g
Division	5g	10g	20g
Verification interval	20g	50g	100g
Operating temperature	-10~40°C		
Material	platform: stainless steel, base: die-cast aluminum		
Dimension of platform	420×520mm		
Power	rechargeable lead acid battery (6V/4Ah)		
Output	RS232		
Weight	18.3kg		



8501-AL150

DATA OUTPUT



printer (optional)

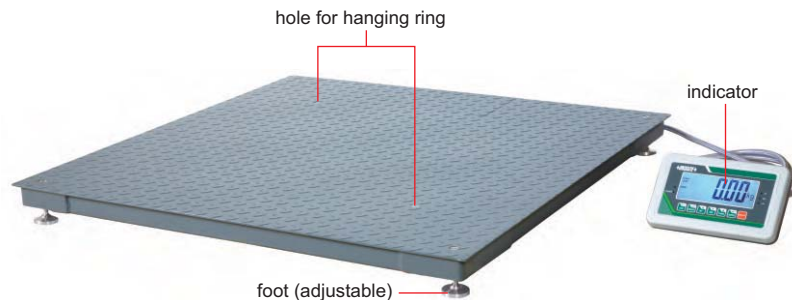
- LCD large screen display with LED backlight
- Weighing, overweight alarm, counting, keyboard lock, accumulating, auto zero and animal scale
- Units: kg, g, lb, oz

OPTIONAL ACCESSORY

Printer	8001-PRINTER
---------	--------------

FLOOR SCALES

- LCD large screen display with automatic backlight
- Zero, overweight alarm, deduction, unit conversion, accumulating, animal scale, etc.
- Units: kg, g, lb, oz
- OIML approved load cell

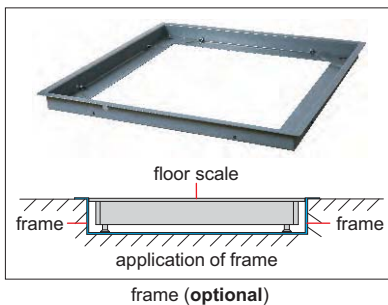


8401-1T1212

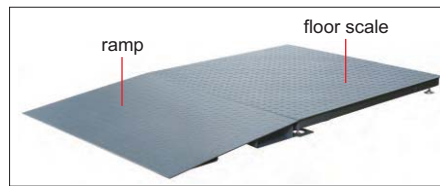
DATA OUTPUT



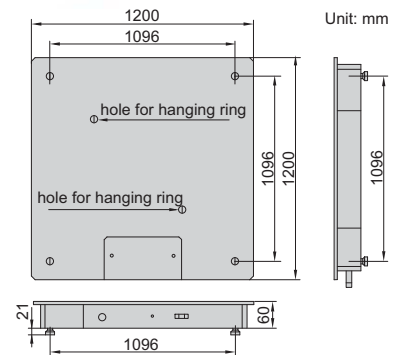
printer (optional)



frame (optional)



ramp (optional)



SPECIFICATION

Code	8401-1T1212	8401-2T1212	8401-3T1212
Maximum capacity	1t	2t	3t
Minimum capacity	10kg	20kg	20kg
Division	0.5kg	1kg	1kg
Verification interval	0.5kg	1kg	1kg
Load cell	4 pcs 350Ω		
Operating temperature	-10~40°C		
Material	mild steel		
Dimension of platform	1200×1200mm		
Power	rechargeable lead acid battery (6V/4Ah)		
Output	RS232		
Weight	140kg		

STANDARD DELIVERY

Main unit	1 pc
Indicator	1 pc
AC/DC adapter	1 pc
Stainless steel foot	4 pcs
Hanging ring	2 pcs

OPTIONAL ACCESSORY

Ramp	8401-1212-1
Frame	8401-1212-2
Stand	8401-STAND
Printer	8001-PRINTER



stand (optional)

WEIGHTS



OIML R111-2004 TOLERANCE

Weight	E2	F1	F2	M1
1mg	0.006mg	0.020mg	0.06mg	0.20mg
2mg	0.006mg	0.020mg	0.06mg	0.20mg
5mg	0.006mg	0.020mg	0.06mg	0.20mg
10mg	0.008mg	0.025mg	0.08mg	0.25mg
20mg	0.010mg	0.03mg	0.10mg	0.3mg
50mg	0.012mg	0.04mg	0.12mg	0.4mg
100mg	0.016mg	0.05mg	0.16mg	0.5mg
200mg	0.020mg	0.06mg	0.20mg	0.6mg
500mg	0.025mg	0.08mg	0.25mg	0.8mg
1g	0.03mg	0.10mg	0.3mg	1.0mg
2g	0.04mg	0.12mg	0.4mg	1.2mg
5g	0.05mg	0.16mg	0.5mg	1.6mg
10g	0.06mg	0.20mg	0.6mg	2.0mg
20g	0.08mg	0.25mg	0.8mg	2.5mg
50g	0.10mg	0.3mg	1.0mg	3.0mg
100g	0.16mg	0.5mg	1.6mg	5.0mg
200g	0.3mg	1.0mg	3.0mg	10mg
500g	0.8mg	2.5mg	8.0mg	25mg
1kg	1.6mg	5.0mg	16mg	50mg
2kg	3.0mg	10mg	30mg	100mg
5kg	8.0mg	25mg	80mg	250mg
10kg	16mg	50mg	160mg	500mg
20kg	30mg	100mg	300mg	1000mg

- Supplied with manufacturer inspection certificate

CLASS SELECTION

Resolution of the weighing instruments	Required class of weights
0.001mg	E1
0.01mg	E2
0.1mg	E2/F1
1mg	F2
0.01g/0.1g	M1

Weight	Class and material						Shape	
	E2 (non-magnetic stainless steel)	F1 (non-magnetic stainless steel)	F1 (304 stainless steel)	F2 (304 stainless steel)	M1 (304 stainless steel)	M1 (steel, chrome plated)		
1mg	8911-1MGE2	8911-1MGF1	8911-1MGF1S	8911-1MGF2	8911-1MGM1	-	sheet	
2mg	8911-2MGE2	8911-2MGF1	8911-2MGF1S	8911-2MGF2	8911-2MGM1			
5mg	8911-5MGE2	8911-5MGF1	8911-5MGF1S	8911-5MGF2	8911-5MGM1			
10mg	8911-10MGE2	8911-10MGF1	8911-10MGF1S	8911-10MGF2	8911-10MGM1			
20mg	8911-20MGE2	8911-20MGF1	8911-20MGF1S	8911-20MGF2	8911-20MGM1			
50mg	8911-50MGE2	8911-50MGF1	8911-50MGF1S	8911-50MGF2	8911-50MGM1			
100mg	8911-100MGE2	8911-100MGF1	8911-100MGF1S	8911-100MGF2	8911-100MGM1			
200mg	8911-200MGE2	8911-200MGF1	8911-200MGF1S	8911-200MGF2	8911-200MGM1			
500mg	8911-500MGE2	8911-500MGF1	8911-500MGF1S	8911-500MGF2	8911-500MGM1			
1g	8911-1GE2	8911-1GF1	8911-1GF1S	8911-1GF2	8911-1GM1			-
2g	8911-2GE2	8911-2GF1	8911-2GF1S	8911-2GF2	8911-2GM1			
5g	8911-5GE2	8911-5GF1	8911-5GF1S	8911-5GF2	8911-5GM1	8911-5GM1C		
10g	8911-10GE2	8911-10GF1	8911-10GF1S	8911-10GF2	8911-10GM1	8911-10GM1C		
20g	8911-20GE2	8911-20GF1	8911-20GF1S	8911-20GF2	8911-20GM1	8911-20GM1C		
50g	8911-50GE2	8911-50GF1	8911-50GF1S	8911-50GF2	8911-50GM1	8911-50GM1C		
100g	8911-100GE2	8911-100GF1	8911-100GF1S	8911-100GF2	8911-100GM1	8911-100GM1C		
200g	8911-200GE2	8911-200GF1	8911-200GF1S	8911-200GF2	8911-200GM1	8911-200GM1C		
500g	8911-500GE2	8911-500GF1	8911-500GF1S	8911-500GF2	8911-500GM1	8911-500GM1C		
1kg	8911-1KGE2	8911-1KGF1	8911-1KGF1S	8911-1KGF2	8911-1KGM1	8911-1KGM1C		
2kg	8911-2KGE2	8911-2KGF1	8911-2KGF1S	8911-2KGF2	8911-2KGM1	8911-2KGM1C		
5kg	8911-5KGE2	8911-5KGF1	8911-5KGF1S	8911-5KGF2	8911-5KGM1	8911-5KGM1C		
10kg	8911-10KGE2	8911-10KGF1	8911-10KGF1S	8911-10KGF2	8911-10KGM1	8911-10KGM1C		
20kg	8911-20KGE2	8911-20KGF1	8911-20KGF1S	8911-20KGF2	8911-20KGM1	8911-20KGM1C		

WEIGHT SETS



■ Supplied with manufacturer inspection certificate

8910-200GF1

CLASS AND MATERIAL

Specification	Code				
	E2 (non-magnetic stainless steel)	F1 (non-magnetic stainless steel)	F1 (304 stainless steel)	F2 (304 stainless steel)	M1 (304 stainless steel)
1mg~100g	8910-100GE2	8910-100GF1	8910-100GF1S	8910-100GF2	8910-100GM1
1mg~200g	8910-200GE2	8910-200GF1	8910-200GF1S	8910-200GF2	8910-200GM1
1mg~1kg	8910-1KGE2	8910-1KGF1	8910-1KGF1S	8910-1KGF2	8910-1KGM1
1mg~2kg	8910-2KGE2	8910-2KGF1	8910-2KGF1S	8910-2KGF2	8910-2KGM1
1mg~5kg	8910-5KGE2	8910-5KGF1	8910-5KGF1S	8910-5KGF2	8910-5KGM1

SPECIFICATION AND SHAPE

Weight	Specification				
	1mg~100g	1mg~200g	1mg~1kg	1mg~2kg	1mg~5kg
1mg	◆	◆	◆	◆	◆
2mg	◆◆*	◆◆*	◆◆*	◆◆*	◆◆*
5mg	◆	◆	◆	◆	◆
10mg	◆	◆	◆	◆	◆
20mg	◆◆*	◆◆*	◆◆*	◆◆*	◆◆*
50mg	◆	◆	◆	◆	◆
100mg	◆	◆	◆	◆	◆
200mg	◆◆*	◆◆*	◆◆*	◆◆*	◆◆*
500mg	◆	◆	◆	◆	◆
1g	■	■	■	■	■
2g	■◆*	■◆*	■◆*	■◆*	■◆*
5g	■	■	■	■	■
10g	■	■	■	■	■
20g	■◆*	■◆*	■◆*	■◆*	■◆*
50g	■	■	■	■	■
100g	■	■	■	■	■
200g		■◆*	■◆*	■◆*	■◆*
500g			■	■	■
1kg			■	■	■
2kg				■◆*	■◆*
5kg					■
Quantity	21 pcs	23 pcs	25 pcs	27 pcs	28 pcs
Total range	1mg~211.11g	1mg~611.11g	1mg~2111.11g	1mg~6111.11g	1mg~11111.11g

◆ sheet ■ cylinder
 ◆* sheet, with mark ■* cylinder, with mark



VIDEO

CUTTING MACHINE CODE MLP-CM60

- For metal and non-metal materials
- Cooling device avoids overheating and destroying sample structure
- With safety switch, the machine will automatically stop when the cover is opened



water tank



SPECIFICATION

Maximum cutting diameter	Ø60mm
Cutting blade	Ø250×1.5×Ø25.4mm
Rotation speed	2800r/min
Motor power	2.2kW
Power supply	AC 380V, 50Hz
Dimension	830×620×450mm
Weight	82kg

STANDARD DELIVERY

Main unit	1 pc
Cutting blade	2 pcs
Coolant	1 barrel (4L)
Water tank	1 pc



cutting blade (optional)



coolant (optional)

OPTIONAL ACCESSORY

Coolant (4L, 1:20 diluted with water)	MLP-CM60-COLT
Cutting blade (Ø250×1.5×Ø25.4mm, 60 pcs/box)	MLP-CM60-CUT2
Cutting blade (Ø250×2×Ø32mm, 50 pcs/box)	MLP-CM60-CUT *
Cutting blade chuck (Ø32mm hole)	MLP-CM60-CHUCK

* When use MLP-CM60-CUT, please purchase MLP-CM60-CHUCK

- Automatic heating, pressuring, cooling and pressure relief
- Water cooling system

SPECIFICATION

Diameter of workpiece	Ø30mm
Heating temperature range	100~200°C
Delay range	0~999s
Hold time	0~999s
Cooling temperature	20~90°C
Heating power	600W
Power supply	AC 220V, 50Hz
Dimension	350×450×470mm
Weight	45kg

STANDARD DELIVERY

Main unit	1 pc
Hot mounting resin	1 bottle (250g)
Funnel	1 pc

MOUNTING PRESS CODE MLP-MP30



VIDEO



hot mounting resin (optional)

OPTIONAL ACCESSORY

Hot mounting resin (black, 4kg)	MLP-MP30-PDR
---------------------------------	--------------

GRINDER AND POLISHER CODE MLP-GP260



- ABS case and stainless steel parts, anti-corrosion, easy to clean
- Can hold up to 4 samples (6 holes are optional and can hold up to 6 samples)
- Smooth rotation, low noise
- Adjustable speed
- Water cooling device and abrasive cleaning nozzle prevent samples from overheating and destroying structure
- Platen rotation direction can be selected
- Replaceable platen

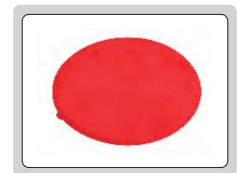


SPECIFICATION

Platen diameter	Ø250mm
Platen rotation speed	50~999r/min (stepless adjustable), 150 or 300r/min (two fixed speeds)
Platen rotation direction	clockwise or counterclockwise
Grinding head speed	50~150r/min (stepless adjustable)
Pressure range	5~60N
Operating time	5~995s
Sample diameter	Ø30mm (can be customized)
Air pressure	0.6~0.9MPa
Power supply	AC 220V, 50Hz
Input power	1.1kW
Dimension	594×795×687mm
Weight	98kg



silicon carbide paper
(optional)



polishing cloth (optional)

STANDARD DELIVERY

Main unit	1 pc
Silicon carbide paper	6 pcs (200, 600, 1000)
Polishing cloth	4 pcs

OPTIONAL ACCESSORY

Silicon carbide paper	MLP-GP260-S□□*	50 pcs/box, select granularity: 120, 180, 240, 400, 600, 800, 1000, 1200, 1500, 2000
Polishing cloth	MLP-GP260-CLT	15 pcs/box, long velvet silk material
Diamond polishing agent	MLP-GP260-D□□*	500ml, select granularity (µm): W40, W28, W20, W14, W9, W7, W5, W3.5, W2.5, W1.5, W1.0, W0.5, W0.25

* □□ is granularity specification, for example, code MLP-GP260-D40 stands for diamond polishing agent 40µm granularity



CODE	PAGE
11	
1102.....	11
1103.....	10
1104.....	10
1106.....	21
1108.....	11
1109.....	12
1110.....	14
1111.....	15
1113.....	8
1114.....	11
1117.....	21
1118.....	8
1119.....	12
1120.....	32
1121.....	33
1122.....	42
1123.....	39
1124.....	30
1125.....	28
1126.....	9
1127.....	9
1128.....	36
1129.....	35
1130.....	13
1135.....	22
1136.....	22
1138.....	40
1139.....	16
1140.....	57
1141.....	51
1142.....	51
1143.....	52
1144.....	52
1145.....	57
1146.....	68
1147.....	52
1148.....	53
1149.....	50
1150.....	66
1154.....	66
1155.....	62
1156.....	65
1157.....	63
1158.....	63
1160.....	235
1161.....	44
1162.....	48
1163.....	181
1165.....	46
1166.....	252
1167.....	49
1168.....	49
1169.....	38
1170.....	15
1171.....	15

CODE	PAGE
1172.....	46
1176.....	34
1177.....	41
1178.....	35
1179.....	45
1180.....	235
1181.....	48
1183.....	39
1184.....	43
1185.....	37
1186.....	43
1187.....	36
1188.....	38
1189.....	42
1191.....	36
1192.....	40
1193.....	13
1196.....	12
12	
1201.....	16
1202.....	17
1203.....	16
1204.....	16
1205.....	17
1207.....	23
1208.....	23
1210.....	23
1214.....	24
1215.....	24
1217.....	18
1223.....	18
1224.....	18
1226.....	19
1233.....	17
1236.....	22
1238.....	18
1239.....	19
1240.....	54
1243.....	56
1244.....	56
1247.....	55
1248.....	55
1249.....	55
1250.....	67
1253.....	68
1262.....	34
1267.....	235
1273.....	47
1275.....	250
1281.....	48
13	
1311.....	16
1312.....	16
1340.....	54
1351.....	67

CODE	PAGE
15	
1520.....	31
1524.....	42
1525.....	41
1526.....	29
1527.....	44
1528.....	45
1529.....	47
1530.....	31
1532.....	39
1533.....	46
1534.....	38
1535.....	37
1536.....	47
1538.....	50
1540.....	54
1541.....	50
21	
2103.....	130
2104.....	130
2108.....	134
2109.....	134
2112.....	129
2113.....	133
2114.....	135
2115.....	132
2116.....	129
2117.....	136
2118.....	135
2120.....	133
2121.....	170
2122.....	119
2124.....	107
2127.....	120
2128.....	121
2131.....	171
2132.....	172
2133.....	127
2134.....	128
2138.....	131
2139.....	131
2140.....	126
2141.....	60
2142.....	58
2143.....	60
2144.....	228
2151.....	171
2152.....	120
2163.....	181
2164.....	181
2166.....	180
2167.....	180
2168.....	182
2170.....	396
2171.....	214

CODE	PAGE
2172.....	218
2174.....	214
2175.....	396
2176.....	215
2179.....	396
2183.....	125
2184.....	178
2186.....	179
2187.....	180
2188.....	126
22	
2222.....	170
2223.....	173
2230.....	184
2231.....	184
2232.....	185
2233.....	185
2234.....	183
2235.....	183
2236.....	187
2237.....	186
2275.....	223
2276.....	250
2278.....	251
23	
2301.....	141
2302.....	144
2307.....	143
2308.....	142
2309.....	145
2310.....	144
2311.....	141
2313.....	141
2314.....	142
2316.....	145
2318.....	144
2321.....	170
2322.....	119
2324.....	143
2326.....	146
2328.....	143
2332.....	172
2333.....	172
2341.....	59
2342.....	59
2343.....	58
2344.....	375
2348.....	122
2361.....	177
2363.....	177
2364.....	174
2365.....	175
2366.....	174
2367.....	176
2372.....	217

CODE	PAGE
2373.....	218
2374.....	217
2380.....	151
2381.....	151
2383.....	152
2385.....	278
2386.....	152
2394.....	282
2395.....	123
2396.....	157
2397.....	282
2398.....	151
2399.....	152
24	
2480.....	153
25	
2501.....	134
27	
2724.....	121
28	
2801.....	142
2824.....	121
2827.....	120
2828.....	121
2841.....	182
2843.....	375
2844.....	374
2852.....	120
2862.....	177
2863.....	177
2866.....	178
2871.....	173
2872.....	174
2873.....	176
2876.....	176
2877.....	175
29	
2925.....	25~27
31	
3101.....	72
3102.....	73
3108.....	73
3109.....	74
3127.....	109~110
3128.....	111
32	
3202.....	75
3203.....	76
3205.....	78
3206.....	79

CODE	PAGE
3208.....	75
3209.....	77
3210.....	78
3220.....	111
3221.....	113
3222.....	114
3224.....	114
3225.....	114
3226.....	118
3227.....	108~109
3228.....	111
3229.....	113
3230.....	86
3231.....	77
3232.....	87
3233.....	89
3234.....	93
3235.....	80
3236.....	77
3238.....	97
3239.....	92
3240.....	61
3241.....	62
3260.....	91
3261.....	90
3262.....	93
3263.....	99
3264.....	99
3266.....	88
3280.....	95
3281.....	83
3282.....	96
3283.....	98
3285.....	100
3287.....	81
3288.....	91
3290.....	94
3291.....	85
3292.....	99
3293.....	100
3294.....	96
3296.....	81
33	
3331.....	80
3332.....	80
3334.....	179
3335.....	178
3350.....	69
34	
3400.....	75
35	
3506.....	79
3520.....	112
3521.....	112

CODE	PAGE
3530.....	86
3532.....	87
3533.....	89
3534.....	94
3538.....	97
3539.....	92
3540.....	61
3560.....	91
3561.....	90
3562.....	93
3565.....	74
3566.....	88
3580.....	96
3581.....	84
3583.....	98
3588.....	92
3590.....	95
3591.....	85
3594.....	97
36	
3634.....	116
3635.....	115
3638.....	116
3639.....	70
3641.....	117
3661.....	70
40	
4001.....	197
4002.....	199
4003.....	268
4004.....	268
41	
4100.....	191
4101.....	192
4105.....	189
4106.....	190
4107.....	194
4108.....	194
4110.....	201
4111.....	188
4113.....	201
4118.....	201
4120.....	207
4121.....	212
4124.....	204
4129.....	208~211
4130.....	204
4131.....	211
4139.....	205~206
4141.....	219
4142.....	220
4143.....	267
4144.....	219
4147.....	226

CODE	PAGE
4155.....	270
4157.....	169
4160.....	195
4164.....	193
4166.....	200
4168.....	213
4176.....	194
4180.....	227
4184.....	100
42	
4206.....	124
4208.....	124
4209.....	124
46	
4601.....	228
4602.....	229
4605.....	229
4608.....	229
4621.....	230
4622.....	230
4630.....	236
4662.....	213
4665.....	213
47	
4700.....	226
4701.....	224
4702.....	226
4705.....	223
4706.....	225
4707.....	222
4710.....	218
4711.....	223
4720.....	167
4721.....	166
4722.....	168
4723.....	167
4725.....	165
4726.....	166
4728.....	169
4745.....	224
4747.....	224
4754.....	225
4760.....	224
4762.....	225
4770.....	219
4771.....	169
4778.....	216
4779.....	215
4780.....	215
4782.....	167
4786.....	166
4788.....	168
4789.....	165
4790.....	220



CODE	PAGE
4791.....	221
4792.....	221
4793.....	221
4794.....	220
4795.....	222
4796.....	222
4797.....	216
4799.....	216
48	
4801.....	233
4802.....	234
4804.....	234
4806.....	233
4807.....	233
4808.....	244
4809.....	245
4810.....	232
4812.....	232
4820.....	231
4824.....	231
4830.....	237
4831.....	237
4832.....	238
4833.....	236
4834.....	238
4835.....	240
4836.....	238
4837.....	236
4838.....	240
4839.....	243
4840.....	242
4841.....	242
4842.....	245
4843.....	245
4844.....	234
4845.....	375
4846.....	241
4847.....	239
4848.....	239
4849.....	241
4850.....	241
4851.....	242
4852.....	237
4860.....	232
49	
4902.....	397
4903.....	398
4904.....	398
4905.....	397
4906.....	397
4907.....	398
4908.....	398
4910.....	399
4911.....	399
4912.....	400

CODE	PAGE
4913.....	400
4914.....	400
4917.....	401
4918.....	401
50	
5013.....	257
5021.....	253
5022.....	253
5023.....	253
5024.....	254
5031.....	254
5032.....	254
5041.....	255
5042.....	255
5051.....	255
5052.....	256
5061.....	256
5062.....	256
5063.....	257
5064.....	243
5071.....	244
5072.....	244
5091.....	257
51	
5101-M500.....	335
5101-M500BD.....	335
5102-M600.....	337
5102-M600BD.....	337
5103-M1000.....	338
5103-M1000BD.....	338
5104-M700.....	336
5106-M50.....	342
5106-M50T.....	342
53	
5301-D400.....	317
5302-AF105.....	315
5303-AF103.....	316
5305-ZS80.....	343
5307-ID100A.....	325
61	
6140.....	19
6141.....	56
6143.....	37
6144.....	20
62	
6200.....	158
6201.....	158
6202.....	158
6207.....	160
6208.....	157
6210.....	158
6211.....	161

CODE	PAGE
6212.....	161
6214.....	160
6215.....	159
6216.....	159
6217.....	160
6224.....	161
6250.....	185
6251.....	183
6252.....	184
6272.....	159
6282.....	146~148
6284.....	153
6291.....	154
6293.....	154
6294.....	278
6295.....	278
6296.....	154
6297.....	154
6298.....	153
63	
6300.....	103
6301.....	102
6307.....	102
6309.....	20
6310.....	103
6312.....	203
6315.....	100
6318.....	101
6353.....	103
6354.....	103
6372.....	104
6373.....	104
6375.....	106
6377.....	106
6381.....	105
6384.....	104
6385.....	104
6386.....	105
6387.....	105
6388.....	106
65	
6520.....	273
6521.....	272
6522.....	271
6523.....	271
6524.....	272
6526.....	273
6527.....	270
6528.....	272
6533.....	266
6534.....	266
6535.....	268
6536.....	270
6537.....	266
6538.....	271

CODE	PAGE
6539.....	264
6547.....	269
6548.....	269
6549.....	269
6553.....	281
6554.....	281
6555.....	282
6556.....	282
6557.....	281
6562.....	280
6566.....	279
6567.....	280
6568.....	280
6571.....	279
6572.....	279
6573.....	280
6582.....	274
6583.....	277
6584.....	275
6585.....	276
6586.....	273
6587.....	276
6588.....	277
68	
6801.....	264
6802.....	261
6803.....	261
6804.....	261
6832.....	239
6862.....	163
6863.....	163
6864.....	162
6865.....	164
6866.....	161
6867.....	162
6869.....	164
6878.....	265
6879.....	267
6881.....	196
6883.....	195
6884.....	198
6886.....	195
6887.....	262
6888.....	262
6889.....	263
6890.....	263
6891.....	264
6892.....	265
6894.....	267
6896.....	260
6897.....	262
6898.....	260
6899.....	265
69	
6900.....	258

CODE	PAGE
6902.....	259
6903.....	258
6990.....	252
71	
7101.....	283
7102.....	283
7106.....	137
7107.....	138
7110.....	249
7111.....	228
7113.....	249
7114.....	126
7117.....	227
7118.....	227
7119.....	249
7120.....	250
7123.....	249
7140.....	247
7142.....	247
7143.....	248
7144.....	248
7145.....	248
7150.....	68
7160.....	356
7161.....	357
7162.....	357
7163.....	357
7164.....	358
72	
7202.....	251
7203.....	252
7205.....	251
7230.....	252
7231.....	252
7232.....	252
7240.....	246
7241.....	246
7247.....	247
7260.....	247
7261.....	246
7262.....	246
73	
7302.....	3-4
7302-ADD10.....	7
7302-ADD5.....	7
7302-HUB.....	6
7302-HUB7.....	6
7304.....	7
7305.....	5-6
7309-B01M.....	139
7309-C01M.....	140
7315.....	2-3
7316.....	1
7321.....	118

CODE	PAGE
7323-OTGC.....	7
7323-OTGC4.....	7
7323-OTGM.....	7
7330.....	150
7331.....	149
7332.....	149
7333.....	149
7340.....	202
7341.....	202
7350.....	123
7351.....	122
7353.....	123
7360.....	136
7381.....	82
7382.....	82
7383.....	117
7384.....	71
7385.....	118
7391.....	85
75	
7511.....	354
7512.....	356
7513.....	355
7514.....	354
7515.....	354
7516.....	353
7517.....	353
7518.....	355
7519.....	355
7520.....	353
7521.....	353
7522.....	355
7523.....	356
7524.....	354
76	
7600.....	395
80	
8001.....	451
8002.....	450
81	
8101.....	451
82	
8201.....	452
8202.....	452
83	
8301.....	450
84	
8401.....	453
85	

CODE	PAGE
8501.....	453
89	
8910.....	455
8911.....	454
91	
9120.....	380
9130.....	382
9131.....	381
92	
9221.....	388
9222.....	389
9241.....	390
9242.....	390
9243.....	391
93	
9331.....	387
9341.....	387
9351.....	388
9361.....	386
9371.....	386
94	
9401.....	295
9404.....	295
9407.....	293-294
95	
9501.....	373
9561.....	380
96	
9631.....	415
9643.....	431
97	
9710.....	393
9720.....	389
ATF	
ATF-1612.....	383-385
ATF-1612H.....	383-385
ATF-1612L.....	383-385
ATF-1612N.....	383-385
ATF-1612W.....	383-385
CMM	
CMM-MN432.....	291
CST	
CST-D101.....	432
CST-D102.....	432
DHG	

CODE	PAGE
DHG-C420.....	64-65
HDT	
HDT-B-□□□.....	430-431
HDT-L410.....	420
HDT-L411.....	421
HDT-LP200.....	419
HDT-LP200B.....	419
HDT-RA151.....	407
HDT-RSR100.....	409
HDT-RW160.....	408
ISD	
ISD-H210.....	308-309
ISD-H320.....	308-309
ISD-H430.....	308-309
ISD-V150A.....	307
ISD-V220CNCA.....	309-310
ISD-V250A.....	307
ISD-V270CNCA.....	309-310
ISD-V300A.....	307
ISD-V370CNCA.....	309-310
ISD-V400A.....	307
ISD-VMM□□□.....	311-312
ISE	
ISE-2DT.....	395
ISF	
ISF-1DF□□□.....	434
ISF-DF□□□.....	433
ISF-F□□□.....	434
ISF-H20A.....	435
ISF-H20D.....	435
ISF-MT1K.....	433
ISF-MT500.....	434
ISF-P30A.....	435
ISF-P30D.....	435
ISF-S□□□.....	436
ISF-TG□□□.....	438
ISF-V10A.....	435
ISF-V10D.....	435
ISHB	
ISHB-B300.....	426
ISHB-C161.....	425
ISHB-D200.....	411
ISHB-D300.....	411
ISHB-H131.....	425
ISHB-M100.....	412
ISHB-MSA.....	415
ISHB-P101.....	424
ISH	
ISH-BRV.....	410
ISH-DSA.....	427
ISH-DSD.....	427



CODE	PAGE
ISH-DS-STANDA.....	427
ISH-DV10.....	413
ISH-DV5.....	413
ISH-DV50.....	413
ISH-MR150.....	407
ISH-MRD200.....	405
ISH-OS2.....	428
ISH-PHB.....	417
ISH-PH-SP9.....	422
ISH-R150.....	408
ISH-RD20.....	406
ISH-RSR400.....	403~404
ISH-RSR500.....	403~404
ISH-RSR600.....	403~404
ISH-S30A.....	428
ISH-S30D.....	428
ISH-SAM.....	429
ISH-SDM.....	429
ISH-SPHA.....	418
ISH-STAC.....	429
ISH-STD.....	429
ISH-TDV1000A.....	414
ISHR	
ISHR-B141.....	423
ISHR-D121.....	422
ISHR-M111.....	423
ISHR-P151.....	424
ISHR-T400.....	402~403
ISHR-T500.....	402~403
ISHR-T600.....	402~403
ISHU	
ISHU-330.....	416
ISHW	
ISHW-B□□□.....	426
ISHW-L□□□.....	426
ISL	
ISL-A1-□□□.....	284~285
ISL-A5-□□□.....	284~285
ISL-B5-□□□.....	284~285
ISL-DR2.....	285
ISL-DR3.....	285
ISL-SET1.....	286
ISM	
ISM-AD-□□□.....	352
ISM-CM20.....	347~348
ISM-CM63.....	345~346
ISM-DL300.....	318~319
ISM-DL301.....	318~319
ISM-DL302.....	320
ISM-DL400.....	327~328
ISM-DL500.....	321~322
ISM-DL510.....	323~324

CODE	PAGE
ISM-DL-COAXIAL.....	330
ISM-DL-LED.....	330
ISM-DL-OB□□□.....	331
ISM-DL-STAGE1.....	329
ISM-LED-100L4.....	329
ISM-LED-9245R.....	329
ISM-LED-BRACKET.....	330
ISM-LED-CTRL.....	329
ISM-MAS100.....	349~350
ISM-MV10.....	346
ISM-PM20.....	352
ISM-PM40.....	352
ISM-PM50.....	352
ISM-PM100.....	352
ISM-PM200SA.....	332
ISM-PM200SB.....	332
ISM-POL1000.....	344
ISM-WF200.....	333~334
ISM-ZS100.....	340
ISM-ZS100T.....	340
ISM-ZS200.....	339
ISM-ZS30.....	343
ISM-ZS50.....	341
ISM-ZS50T.....	341
ISM-ZS70-S.....	351
ISM-ZS-LED.....	330
ISO	
ISO-2000FN.....	372
ISP	
ISP-A1000E.....	297~298
ISP-A3000E.....	301~302
ISP-A5000E.....	299~300
ISP-A6000.....	305~306
ISP-A6000E.....	305~306
ISP-A7000E.....	303~304
ISP-AZ3020.....	299~300
ISP-W3020.....	301~302
ISP-W4025.....	303~304
ISP-Z3015.....	297~298
ISQ	
ISQ-DB50.....	155~156
ISQ-DG.....	391
ISQ-DG8.....	392
ISQ-DRM31.....	394
ISQ-PK100.....	374
ISQ-RA600.....	125
ISQ-RM30.....	394
ISQ-TS120K.....	394
ISR	
ISR-C002.....	366~367
ISR-C003.....	370
ISR-C300.....	368~369
ISR-CS□□□.....	370

CODE	PAGE
ISR-CS017.....	371
ISR-CS018.....	371
ISR-CS130-W.....	371
ISR-RS□□□.....	371
IST	
IST-11WM□□□.....	446
IST-15W□□□.....	445
IST-2W□□□.....	443~444
IST-5W135A.....	448
IST-5W200A.....	448
IST-5W30A.....	448
IST-5W340A.....	448
IST-9WM□□□.....	447
IST-DCT10.....	440
IST-DCT2.....	440
IST-DCT20.....	440
IST-DCT5.....	440
IST-DS□□□.....	440
IST-DTT1.....	439
IST-DTT10.....	439
IST-DTT5.....	439
IST-DW□□□.....	448
IST-MG□□□.....	441
IST-PW□□□.....	447
IST-SD200.....	441
IST-SD400.....	441
IST-SD50.....	441
IST-TM□□□.....	449
IST-TS500.....	439
IST-TT□□□.....	438
IST-W□□□.....	442
IST-WP12.....	442
IST-WP20.....	442
IST-WP6.....	442
IST-WS30.....	443
IST-WS30A.....	443
IST-WS60.....	443
IST-WS85.....	443
ISU	
ISU-100D.....	379
ISU-250C.....	379
ISU-300D.....	378
ISU-700D.....	377
ISU-710D.....	377
ISU-720D.....	376
ISV	
ISV-1H□□□.....	364
ISV-1HLED.....	365
ISV-1LED1.....	366
ISV-2000DS.....	361
ISV-2001DS.....	361
ISV-2002DS.....	361
ISV-2CAM.....	365
ISV-3000DS.....	361

CODE	PAGE
ISV-3001DS.....	361
ISV-3002DS.....	361
ISV-4000DS.....	361
ISV-E10.....	363
ISV-E20.....	364
ISV-MS714.....	360
ISV-MS716.....	360
ISV-MS724.....	360
ISV-MS726.....	360
ISV-MS734.....	360
ISV-MS736.....	360
ISV-RV.....	363
ISV-VP280.....	362
ISY	
ISY-100.....	289~290
LDM	
LDM-030.....	292
LDM-065.....	292
MLP	
MLP-CM60.....	456
MLP-GP260.....	457
MLP-MP30.....	456
SPM	
SPM-1000.....	287~288
TLP	
TLP-P340.....	296
UTM	
UTM-E10.....	437
UTM-E100.....	437
UTM-E300.....	437
UTM-E50.....	437
VSP	
VSP-201.....	358~359

APPLICATION INDEX OF MEASURING TOOLS

SHAFT DIAMETER



Dial Snap Gages
2186-
(page 179)



Adjustable Snap Gages
2187- (page 180)



Indicating Micrometers
3332- (page 80)



Micrometers With Dial Indicator
3296-, 3331-
(page 80-81)



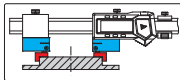
Dial Snap Gages
3335-, 3334-
(page 178-179)



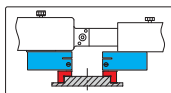
Outside Micrometers
(page 72-79)



Universal Calipers
1125-
(page 28)



Universal Comparison Gages
2925-
(page 25-27)



Digital/Dial/Vernier Calipers
(page 8-24)



External Caliper Gages
2131-, 2333-, 2332-, 2132-
(page 171-172)



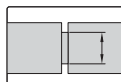
Circumference Tapes
7114-
(page 126)



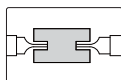
EXTERNAL GROOVE DIAMETER



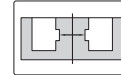
Digital Blade Calipers
1188-, 1532-
(page 38-39)



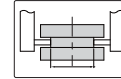
Blade Micrometers
3232-, 3532-
(page 87)



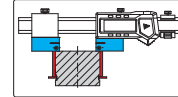
Digital Outside Neck Calipers
1187-
(page 36)



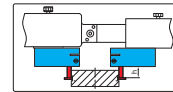
Digital Calipers With Interchangeable Points
1526-, 1124-, 1530-
(page 29-31)



Universal Calipers
1125-
(page 28)



Universal Comparison Gages
2925-
(page 25-27)



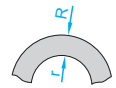
External Caliper Gages
2131-, 2333-, 2332-, 2132-
(page 171-172)



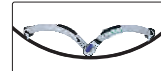
Outside Calipers
7262-, 7241-
(page 246)



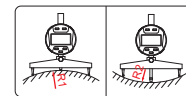
ARC RADIUS



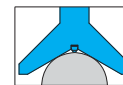
Large Diameter Gage
ISQ-RA600 (page 125)



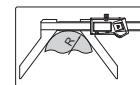
Digital Radius Gage
2183
(page 125)



Digital Radius Gage
2188-
(page 126)



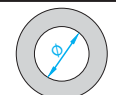
Digital Arc Radius Calipers
1189- (page 42)



Radius Gages
4801-, 4804-
(page 233)



BORE DIAMETER



APPLICATION INDEX OF MEASURING TOOLS

Digital/Dial/Vernier Calipers With Internal Measuring Jaws
(page 8-24)



Universal Calipers
1125-
(page 28)



Universal Comparison Gages
2925-
(page 25-27)



Digital Inside Knife-edge Calipers
1123-, 1138-
(page 39-40)



Inside Micrometers
3220-, 3520-
(page 111-112)



Three Points Internal Micrometers
3227-, 3127-, 3228-, 3128-
(page 108-111)



Pistol Grip Three Points Bore Gages
2124-
(page 107)



Tubular Inside Micrometers
(page 112-116)



Bore Gages
(page 119-122)



Telescoping Gages
4208-, 4206-, 4209-
(page 124)



Inside Spring Calipers
7261-, 7240-
(page 246)



Internal Caliper Gages
2121-, 2222-, 2321-, 2151-, 2223-
(page 170-173)



Taper Bore Gages
4852-
(page 237)



Pin Gages
(page 200-202)



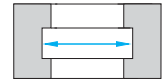
Plain Plug Gages
4124- (page 204)



Taper Gages
4833-, 4837-
(page 236)



DIAMETER OF GROOVE INSIDE HOLES



Universal Calipers
1125-
(page 28)



Universal Comparison Gages
2925-
(page 25-27)



Digital Calipers With Interchangeable Points
1526-, 1124-, 1530-
(page 29-31)



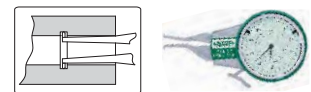
Inside Groove Calipers
(page 31-36)



Accessory Set For Digital Calipers
6144- (page 20)



Internal Caliper Gages
2121-, 2222-, 2321-, 2151-, 2223-
(page 170-173)



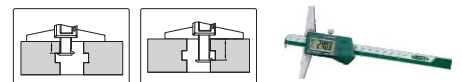
WIDTH AND POSITION OF GROOVE INSIDE HOLES



Digital Hook Calipers
1122-
(page 42)



Depth Gages With Hook
1142-, 1144-
(page 51-52)
1540-, 1248-, 1243-
(page 54-56)

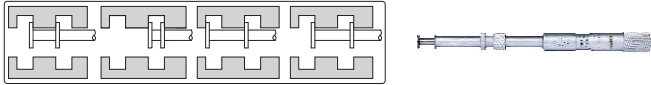


Digital Depth Gages With Round Depth Bar
1148-
(page 53)

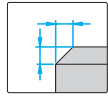


APPLICATION INDEX OF MEASURING TOOLS

Groove Micrometers
3287- (page 81)



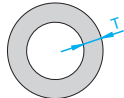
CHAMFER



Chamfer Gages
4844-, 1180-, 1267-
(page 234)



TUBE WALL THICKNESS



Ultrasonic Thickness Gages
(page 376-379)



Digital Tube Thickness Calipers
1161- (page 44)



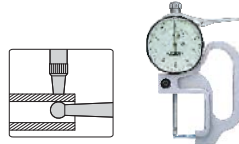
Cylindrical Anvil Tube Micrometers
3261-, 3561-
(page 90)



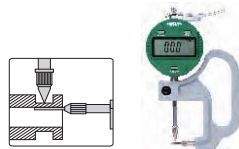
Spherical Anvil Tube Micrometers
3260-, 3560-
(page 91)



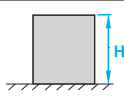
Tube Thickness Gages
2876-, 2367-
(page 176)



Digital Tube Thickness Gages
2873-
(page 176)



HEIGHT



1D Manual Height Gage
DHG-C420
(page 64-65)



Digital Height Gages
1155-, 1157-, 1158-
(page 62-63)



Height Gages
(page 65-68)



Dial Indicator Stands
6866-, 6867-, 6863-, 6864-, 6862-, 6869-
(page 178-181)



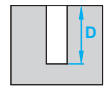
Transfer Stands
6865-
(page 181)



Mini Digital Height Gages
1146-
(page 68)



DEPTH



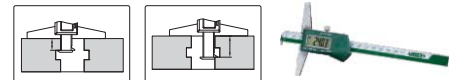
Depth Gages
(page 50-51)



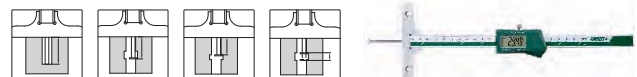
Depth Gages With Point
1143-
(page 52)



Depth Gages With Hook
1142-, 1144- (page 51-52)
1540-, 1248-, 1243-
(page 54-56)



Digital Depth Gages With Round Depth Bar
1148- (page 53)



Mini Depth Gages
1244-, 1145-, 1140-
(page 56-57)



APPLICATION INDEX OF MEASURING TOOLS

Dial/Digital Depth Gages
2343-, 2142-, 2341-, 2342-, 2141-
(page 58-60)



Internal Caliper Gages
2121-, 2222-, 2321-, 2151-, 2223
(page 170-173)



Depth Micrometers
3540-, 3240-, 3241-
(page 61-62)



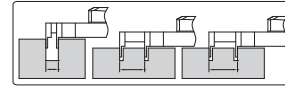
Feeler Gages
4601-, 4602-, 4605-
(page 228-229)



Digital/Dial/Vernier Calipers With Depth Bar
(page 8-19)



Step And Gap Gages
2168-
(page 182)



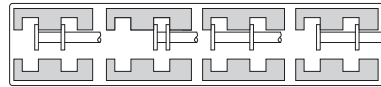
THICKNESS



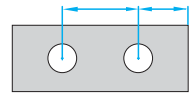
Thickness Gages
(page 173-178)



Groove Micrometers
3287- (page 81)



HOLE CENTER-TO-CENTER AND CENTER-TO-EDGE DISTANCE



Digital Snap Gages
2166-, 2167-, 2163-, 1163-
(page 180-181)



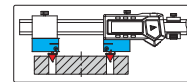
Digital Centering Calipers
1192-, 1177-, 1525-,
1524- (page 40-42)



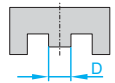
External Caliper Gages
2131-, 2333-, 2332-, 2132-
(page 171-172)



Universal Calipers
1125-
(page 28)



SHAFT DIAMETER INSIDE HOLE



Caliper Type Micrometers
3238-, 3538-
(page 97)



Universal Comparison Gages
2925-
(page 25-27)



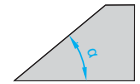
Jaw Type Micrometers
3283-, 3583-
(page 98)



Accessory Set For Digital Calipers
6144-
(page 20)



ANGLE



Digital Outside Neck Calipers
1187-
(page 36)



Protractors
(page 214-216)



SLOT WIDTH



Taper Gages
4833-, 4837-
(page 236)



Protractors
2374-, 2372-, 2373-, 2172-
(page 217-218)



Taper Slot Gages
1160-, 4630-
(page 235-236)



Squares
4745-, 4747-, 4760-, 4762-, 4706-, 4754-
(page 224-225)



Angle Gages
4806-, 4807
(page 232)



APPLICATION INDEX OF MEASURING TOOLS

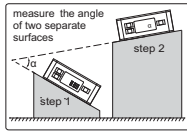
Angle Gage Blocks
4002-
(page 199)



Bench Centers
(page 166-169)



Digital Levels And Slope Meters
2175-, 2179-, 2170-
(page 392)



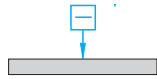
V-blocks
(page 260-262)



Magnetic V-blocks
(page 263-265)



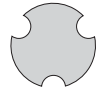
STRAIGHTNESS AND FLATNESS



Straight Edges
(page 226-227)



DIAMETER OF CUTTING TOOLS WITH ODD FLUTES



Digital V Type Calipers
1529-, 1273-
(page 47)



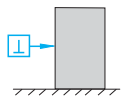
Straightness/flatness Gage
2144-
(page 228)



V-Anvil Micrometers
3290-, 3590-
(page 94-95)



SQUARENESS



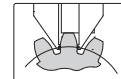
Squares
4141-, 4144-, 4710-
(page 218-219)



GEAR AND SPLINE



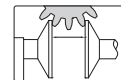
Digital Gear Tooth Calipers
1181-, 1281-
(page 48)



Granite Squares With V Groove
4142- (page 220)
6539- (page 264)



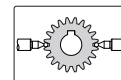
Disk Micrometers
3282-, 3294-, 3594-
(page 96-97)



Perpendicularity Testers
4770-
(page 219)



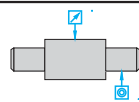
External Gear Tooth Micrometers
3291-, 3591- (page 85)



Squares
(page 220-223)



COAXIALITY AND RUNOUT



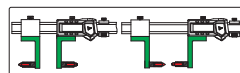
Concentricity Gages
(page 165-166)



Internal Gear Tooth Micrometers
3638-
(page 116)



Universal Calipers
1125- (page 28)



APPLICATION INDEX OF MEASURING TOOLS

Universal Comparison Gages
2925- (page 25-27)



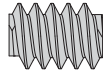
Digital Calipers With Interchangeable Points
1526-, 1124-
(page 29-30)



Gear Tooth Pitch Gages
4860-
(page 231)



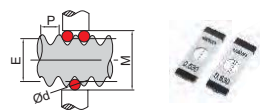
THREAD



Threaded Hole Location Gages
4662-, 4665-
(page 213)



3-wires
7382-
(page 82)



External Screw Thread Micrometers
3639- (page 70)
3281-, 3581-
(page 83-84)



Internal Screw Thread Micrometers
3641-, 3226-
(page 117-118)



Thread Plug Gages
(page 204-211)



Thread Ring Gages
(page 207-212)



Pitch Gages
4824-, 4820-
(page 230-231)



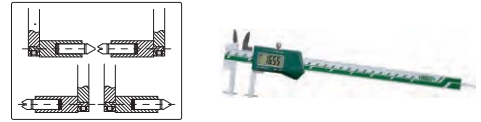
Universal Calipers
1125-
(page 28)



Universal Comparison Gages
2925- (page 25-27)



Digital Calipers With Interchangeable Points
1526-, 1124-
(page 29-30)



FOR OIL PIPES AND FLANGES

Thread Pitch Measuring Instruments
2235-, 2234-
(page 183)



Thread Taper Measuring Instruments
2230-, 2231-
(page 184)



Thread Height Measuring Instruments
2232-, 2233-
(page 185)



Thread Crest Diameter Measuring Instruments
2237-, 2236-
(page 186-187)



Digital Calipers With Interchangeable Ball Tips
1527-, 1528-
(page 44-45)



Digital RTJ Ring Groove Calipers
1179-
(page 45)



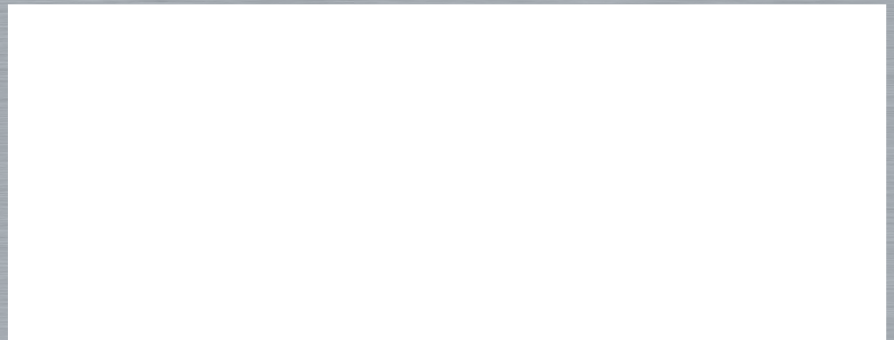


www.insize-eu.com

Application index of
measuring tools
(page 463-468)



Distributed by:



INSIZE EUROPE S.L.

Add: Plg. Ugaldeguren I P3-Hall 2
48170-Zamudio (Bizkaia) Spain

Tel: +34-94-4544308

E-mail: europe@insize.com

Website: www.insize-eu.com