



HELIOS · PREISSER



# METROLOGY CATALOGUE

In Germany at home – in demand worldwide

**2019/2020**

valid from 01.07.2019 to 30.06.2021

[www.helios-preisser.de](http://www.helios-preisser.de)

# METROLOGY CATALOGUE 2019/2020



Calipers



Dial gauges and indicators



Micrometers

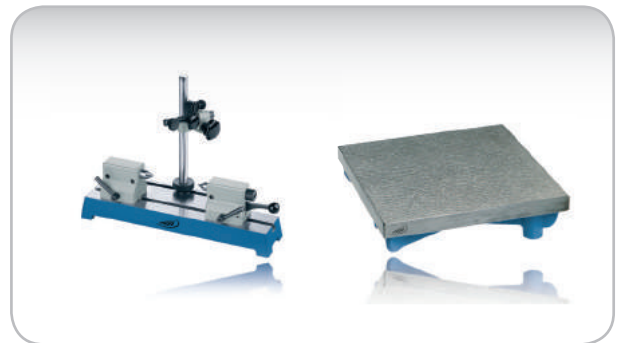

Bench centres &  
inspection plates



Plug gauges &  
Feeler gauge tapes

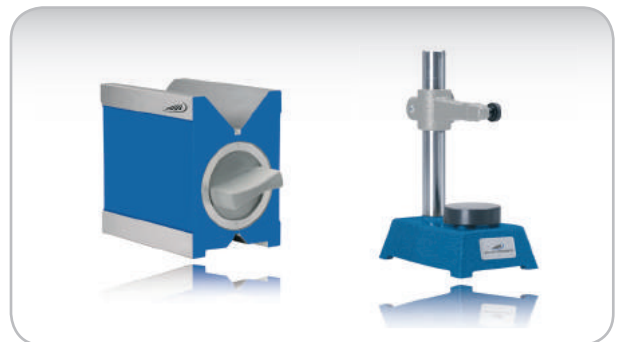

Inspection equipment



Services

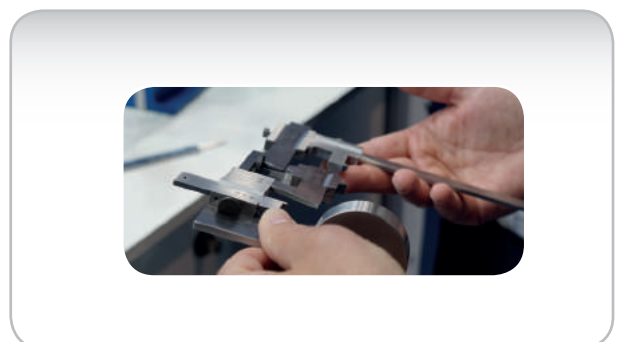

Custom made products



HELIOS · PREISSER

## In Germany at home

For more than 75 years



**Our headquarters  
on the Swabian Alps**

*„For more than 75 years,  
your reliable partner for  
everything about metrology“*



HELIOS • PREISSER



Siegfried Lorch  
Managing director  
Production

Rainer Fahrenholz  
Managing director  
Sales

Dear customer,

For more than 75 years,  
HELIOS-PREISSER is a flexible and  
reliable partner regarding metrology –  
for our traders as well as for end users  
in craft and industry.

In our standard product range, you can  
find almost 3.500 articles, which we are  
producing mainly in Germany.  
130 capable and experienced employees  
ensure an excellent quality of our products,  
a good availability and a service that  
adjusts to your demands.

And if our standard is not enough for you,  
we will gladly design, construct and  
produce a hand measuring tool especially  
for your requirements.

Challenge us, when it comes to quality in  
products and services.  
We are looking forward to convince you of  
our capability.



We are certified according to  
DIN EN ISO 9001:2015



*„Success driven by  
motivation, dedication  
and a strong team“*

**Quality as a result of dedication.**

**With us, you get the experience from more than 100 experts  
in every field of metrology.**

**And to keep it that way, we are offering a qualified training and  
enable our employees to write their own success stories  
within our company.**



**WE ARE AN APPROVED  
TRAINING COMPANY**

## Our great strength

Special measuring instruments

Designed according to your wishes



**MEASURING  
PROBLEM**



**CONSTRUCTION**



Special parts, forms or materials often require a particular measuring instrument geared to your requirements



Based on your specifications, we design your individual measuring tool - including 3D model and drawing

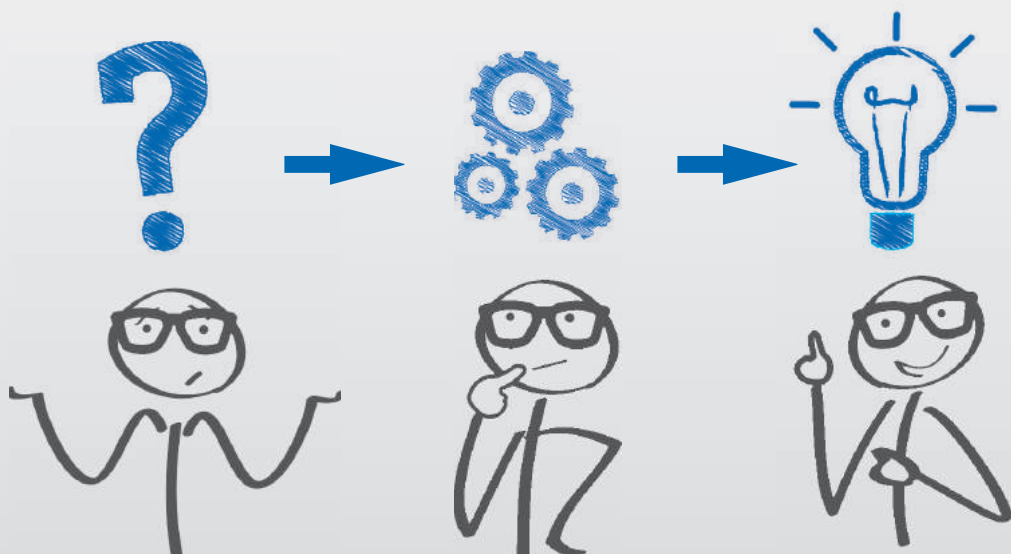

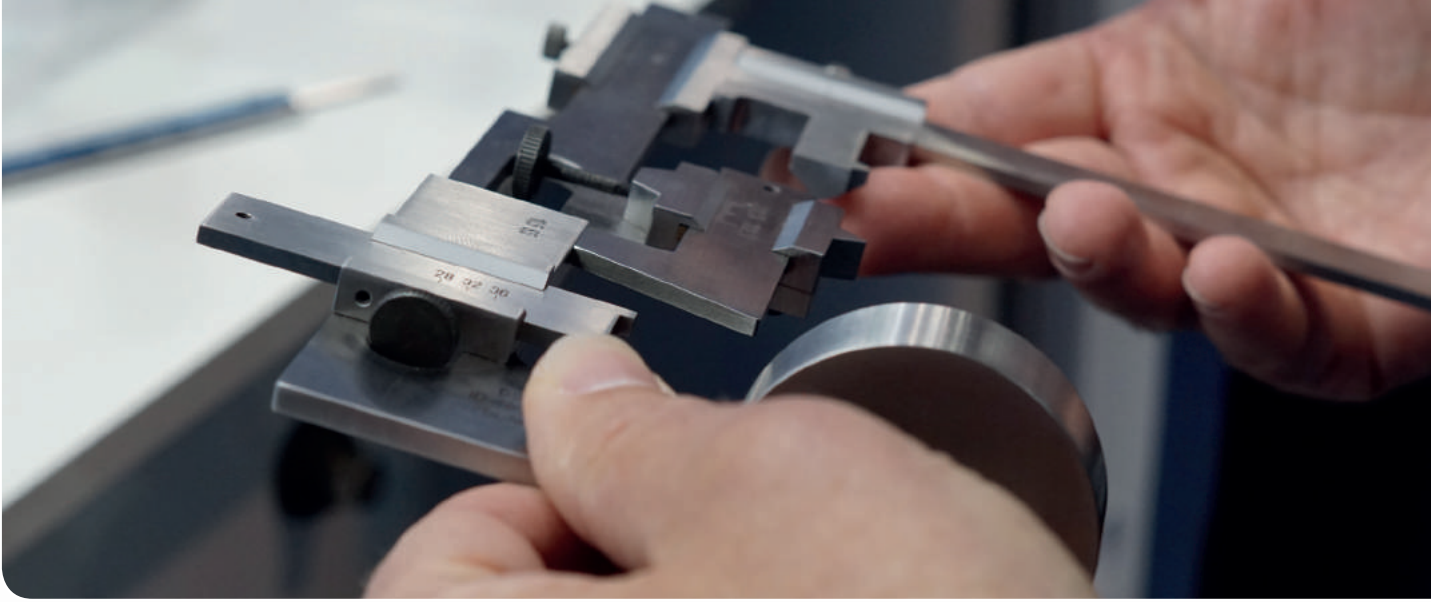

## ASSEMBLY

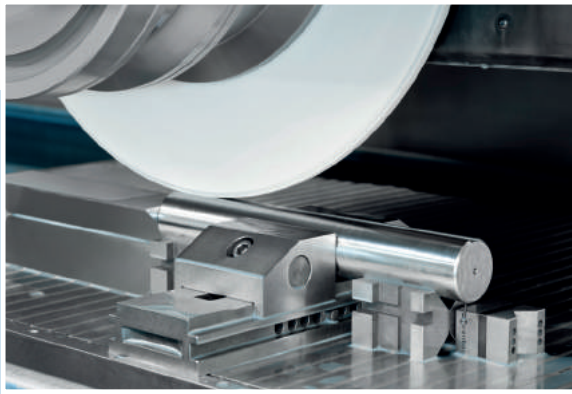

The measuring instrument is manufactured and calibrated especially for you at our production site in Gammertingen



## THE IDEAL SOLUTION

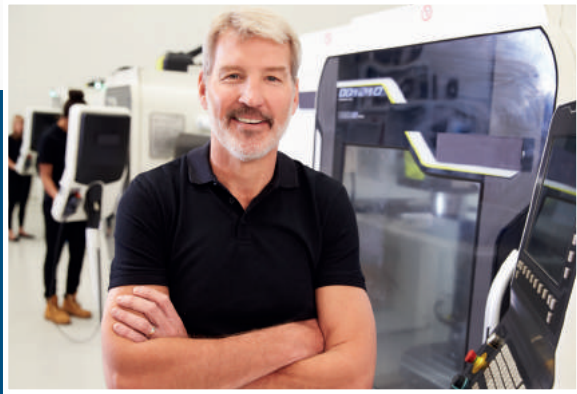

You get the ideal tool, customized to your individual requirements - guaranteed

**FAST** >>>  
**DELIVERY**

**PLUG GAUGES  
WITH SPECIAL DIMENSIONS**



Custom-made  
**according to ISO Fits**

or according to your  
**Nominal size & tolerance**





## Services that leave no questions unasked



### Precise

You get a completely overhauled product, tested and approved - and immediately ready for use.



### Fast

The exchange product will generally leave our company within 24 hours after the arrival of your product.



### Reliable

No bad surprises regarding costs. Due to our transparent Repair-Exchange prices, you have full control on your expenses.



### Cost-efficient

Your exchange product comes in familiar HELIOS-PREISSER quality and with 6 months of warranty.





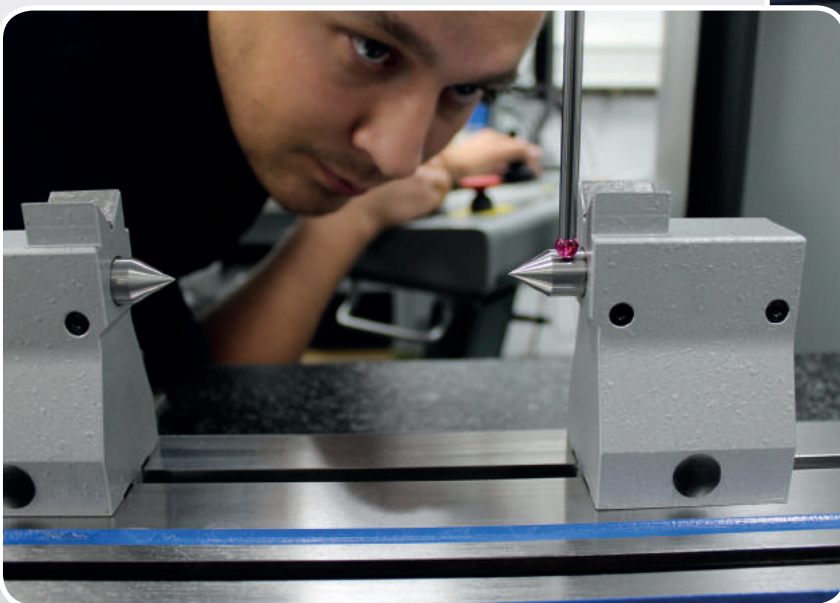
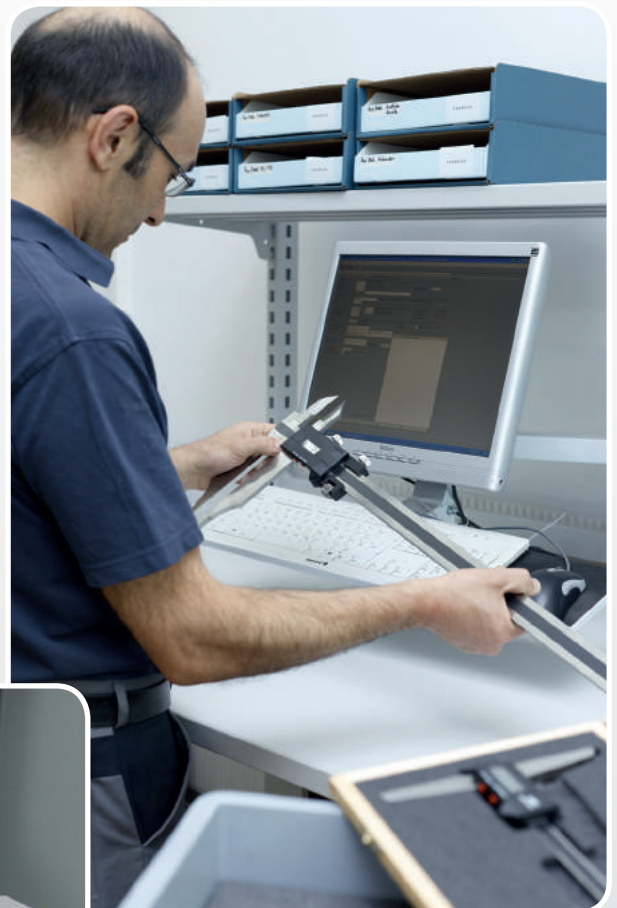

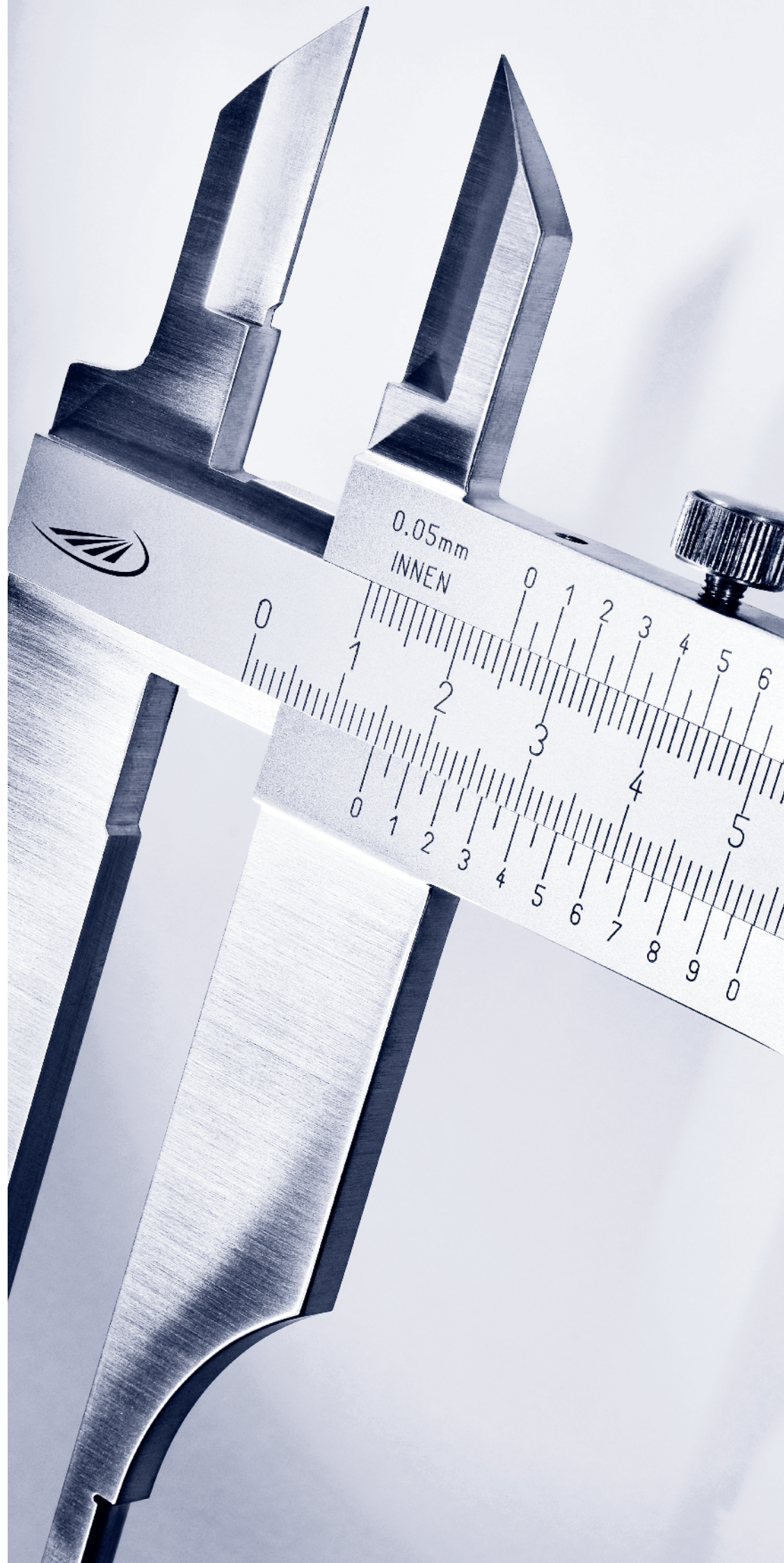

*„Proficient consultation  
& first-class service  
- we are here for you“*

- Comprehensive technical support**
- Competent after-sales service**
- Professional repairs**
- Calibration and monitoring**





# CONTENTS CATALOGUE

1	Calipers	
2	Micrometers	
3	Dial gauges and Indicating instruments	
4	Marking instruments	
5	Squares, Protractors, Bevel protractors	
6	Inspection equipment, Standards, Rules	
7	Data transmission	
8	Calibration service, Order number index, Keyword index	



# SAMPLES CALIPER

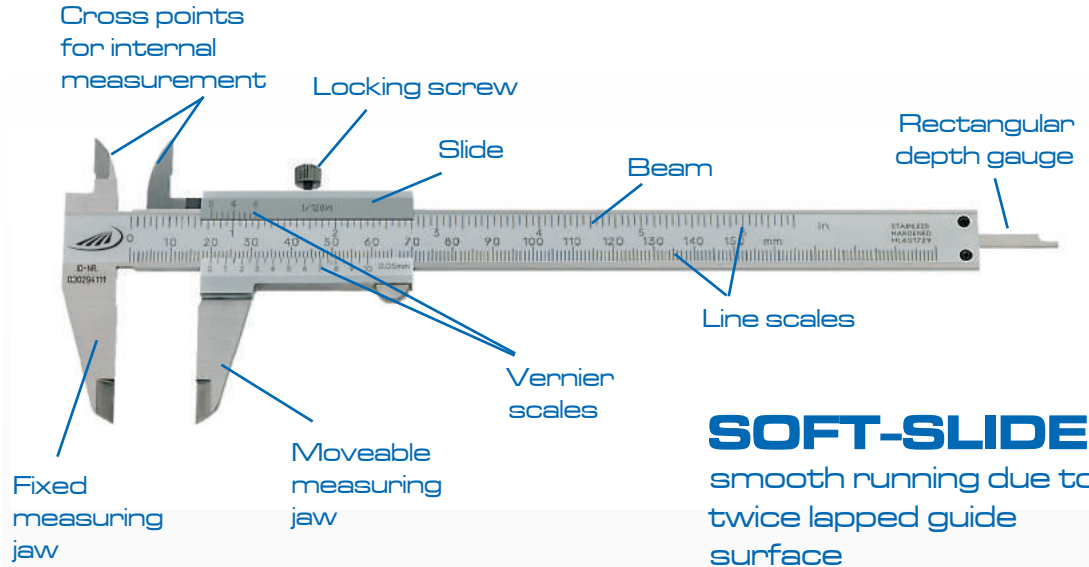

**SOFT-SLIDE**  
smooth running due to twice lapped guide surface

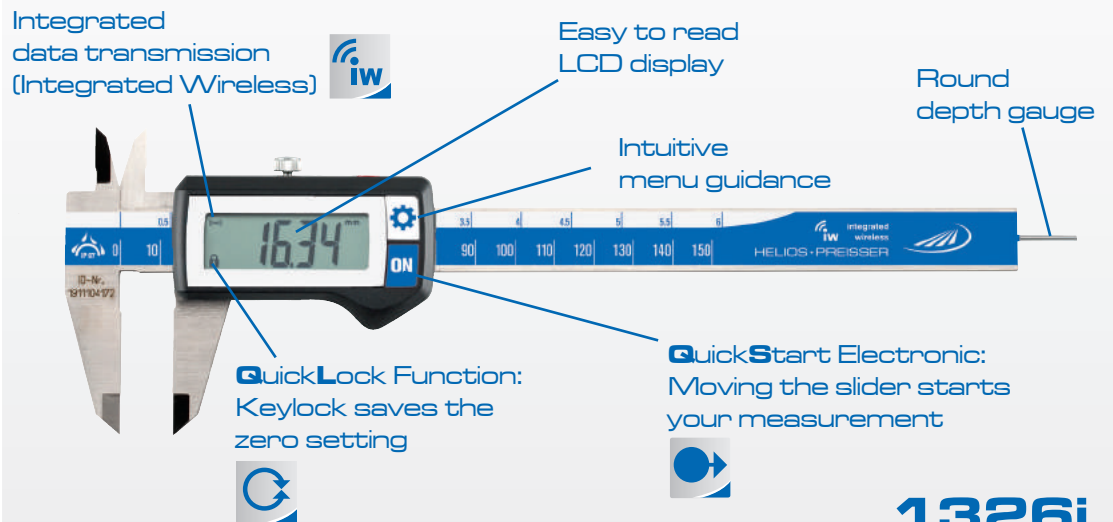

**1326i**  
with integrated wireless

## Possible application for **calipers**

### External measurement

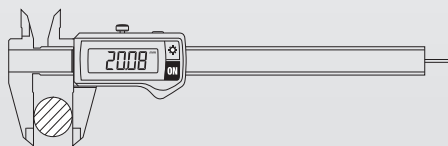

### Internal measurement

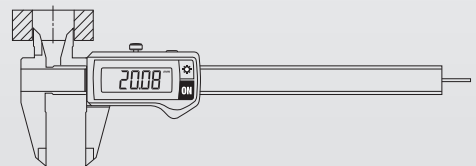

### Depth measurement



### Step (distance) measurement

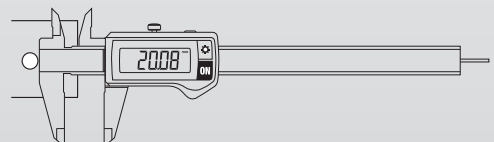

# 1. CHAPTER CALIPERS

14	Pocket vernier calipers
20	Pocket calipers / Tyre profile depth gauge
21	Pocket calipers with dial
22	Measuring tool sets
24	Digital pocket calipers
30	Digital pocket calipers for specific measuring tasks
36	Steel gauge block inspection set for calipers
37	Vernier workshop calipers
44	Workshop caliper with dial / Lightweight workshop calipers
45	Analogue caliper with cross points / gripper points
46	Digital workshop calipers
57	Contraction vernier calipers
59	Calipers for external locking grooves
60	Brake drum vernier calipers / Brake disc inspection gauges
61	Calipers for internal locking grooves
62	Calipers for 3/5 point measurement / for milling tool setting
64	Chamfer / Radius gauges
64	Gear tooth calipers
65	Vernier depth gauges
69	Digital depth gauges
77	Digital depth gauges with interchangeable inserts
80	Digital depth gauge for one-handed operation
82	Digital mounting scales
83	Wooden cases



## 0184 Pocket vernier calipers



DIN  
862

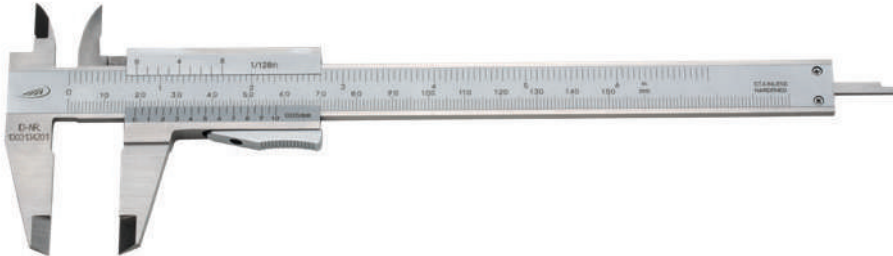

### Model

- Stainless steel
- Reading parts have a satin chrome finish
- DIN 862
- Inside cross points
- Low-set master scale
- Four way measurement
- Includes thread table

### Delivery

- Imitation leather case

✕	📏	Measuring range		Jaw length		Reading		Error limit	Depth gauge	Order no.	List price
		mm	inch	mm	inch	mm	inch	mm			EUR
<b>With thumb clamp</b>											
		0 - 150	0 - 6	40	1.6	0.05	1/128	0.05	rectangular	0184 501	26.00
		0 - 200	0 - 8	40	1.6	0.05	1/128	0.05	rectangular	0184 505	34.50
		0 - 300	0 - 12	50	2.0	0.05	1/128	0.05	none	0184 508	51.00

## 0185 Pocket vernier calipers



DIN  
862

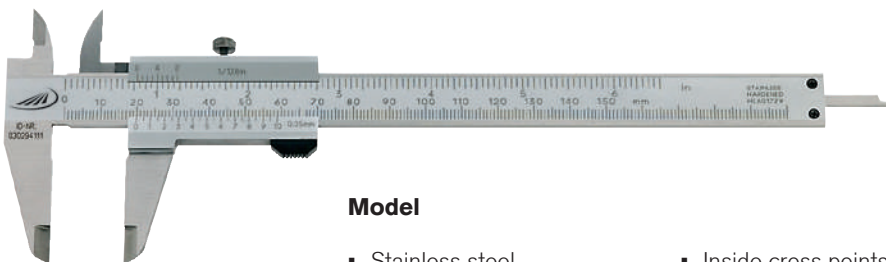

### Model

- Stainless steel
- Reading parts have a satin chrome finish
- DIN 862
- Inside cross points
- Low-set master scale
- Four way measurement
- Includes thread table

### Delivery

- Imitation leather case

✕	📏	Measuring range		Jaw length		Reading		Error limit	Depth gauge	Order no.	List price
		mm	inch	mm	inch	mm	inch	mm			EUR
<b>With locking screw</b>											
		0 - 100	0 - 4	30	1.2	0.05	-	0.05	rectangular	0185 500	20.00
		0 - 150	0 - 6	40	1.6	0.05	1/128	0.05	rectangular	0185 501	26.00
		0 - 200	0 - 8	50	2.0	0.05	1/128	0.05	rectangular	0185 505	34.50
		0 - 300	0 - 12	60	2.4	0.05	1/128	0.05	none	0185 508	51.00



## 0188 / 0189 Pocket vernier calipers



**DIN 862**

**1**

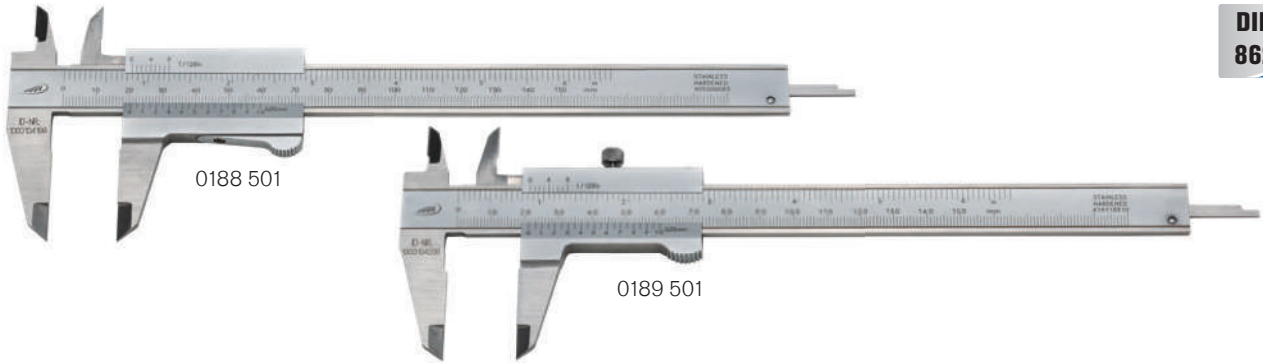

### Model

- Stainless steel
- Reading parts have a satin chrome finish
- DIN 862
- Inside cross points
- Low-set master scale
- Four way measurement
- Includes thread table

### Delivery

- Imitation leather case

Icon	Measuring range		Jaw length		Reading		Error limit	Depth gauge	Order no.	List price
	mm	inch	mm	inch	mm	inch				
With thumb clamp	0 - 150	0 - 6	40	1.6	0.05	1/128	0.05	rectangular	0188 501	23.00
With locking screw	0 - 150	0 - 6	40	1.6	0.05	1/128	0.05	rectangular	0189 501	23.00

## 0194 / 0195 Pocket vernier calipers with round depth rod



**DIN 862**

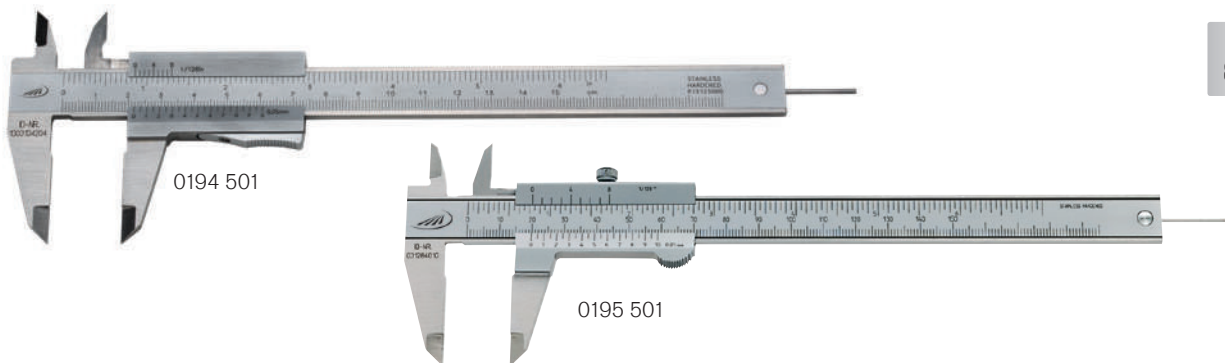

### Model

- Stainless steel
- Reading parts have a satin chrome finish
- DIN 862
- Inside cross points
- Low-set master scale
- Four way measurement
- Includes thread table

### Delivery

- Imitation leather case

Icon	Measuring range		Jaw length		Reading		Error limit	Depth gauge	Order no.	List price
	mm	inch	mm	inch	mm	inch				
With thumb clamp	0 - 150	0 - 6	40	1.6	0.05	1/128	0.05	round 1.6	0194 501	27.00
With locking screw	0 - 150	0 - 6	40	1.6	0.05	1/128	0.05	round 1.6	0195 501	27.00





## 0196 Pocket vernier calipers with reading 0.02 mm



### Model

- Stainless steel
- Reading parts have a satin chrome finish
- DIN 862
- Inside cross points
- Low-set master scale
- Four way measurement
- Includes thread table

### Delivery

- Imitation leather case

**DIN  
862**

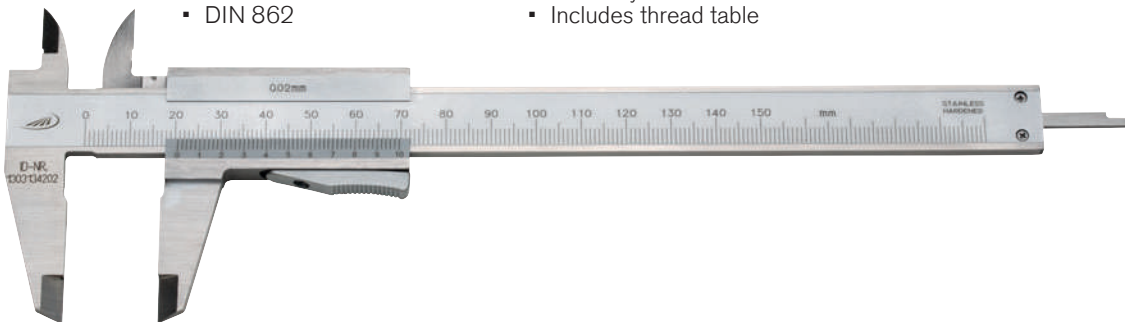

	Measuring range		Jaw length		Reading	Error limit	Depth gauge	Order no.	List price
	mm	inch	mm	inch	mm	mm			EUR
<b>With thumb clamp</b>	0 - 150	0 - 6	40	1.6	0.02	0.03	rectangular	019650 105	25.10

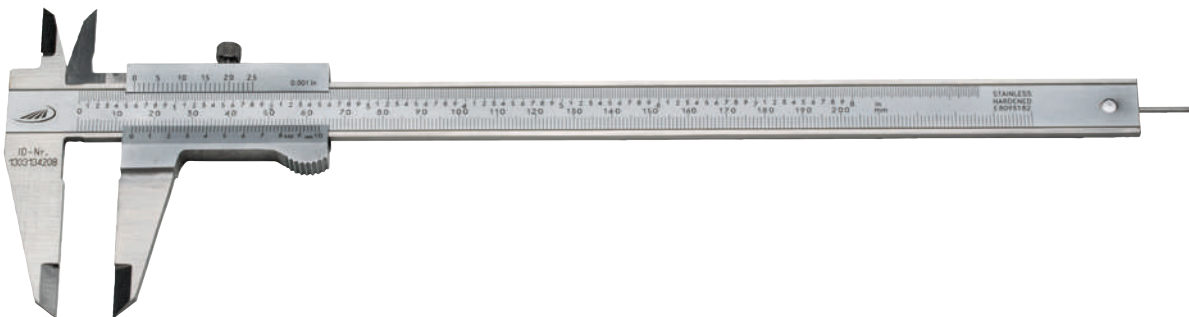

	Measuring range		Jaw length		Reading	Error limit	Depth gauge	Order no.	List price
	mm	inch	mm	inch	mm	mm			EUR
<b>With locking screw</b>	0 - 200	0 - 8	50	2.0	0.02	0.03	round 1.6	019650 516	35.90

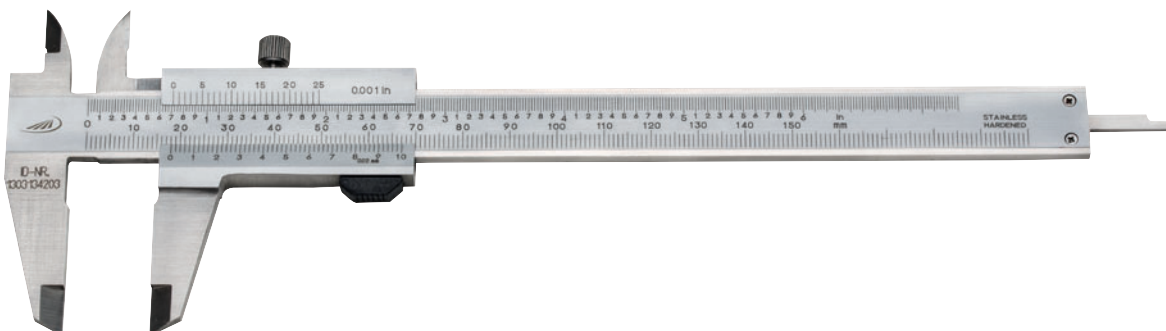

	Measuring range		Jaw length		Reading	Error limit	Depth gauge	Order no.	List price
	mm	inch	mm	inch	mm	mm			EUR
<b>With locking screw</b>	0 - 150	0 - 6	40	1.6	0.02	0.03	rectangular	019650 116	25.10



35,219

## 0197 Pocket vernier calipers SOFT - SLIDE



DIN 862

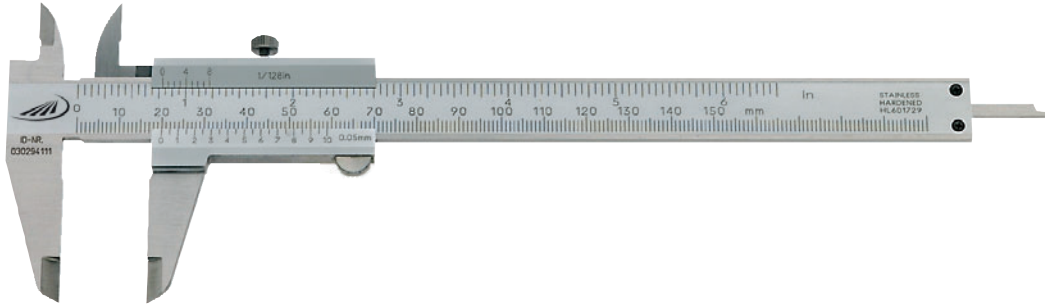

1

### Model

- Smooth running due to twice lapped guide surface
- Stainless steel
- Reading parts have a satin chrome finish

### Delivery

- Imitation leather case

DIN 862	Measuring range		Jaw length		Error limit	Depth gauge	Order no.	List price
	mm	inch	mm	inch				
	0 - 150	0 - 6	40	1.6	0.05	rectangular	0197 501	33.00
	0 - 200	0 - 8	50	2.0	0.05	rectangular	0197 505	75.00
	0 - 300	0 - 12	60	2.4	0.05	none	0197 508	149.00

## 0198 / 0199 Pocket vernier calipers with parallax-free reading



DIN 862

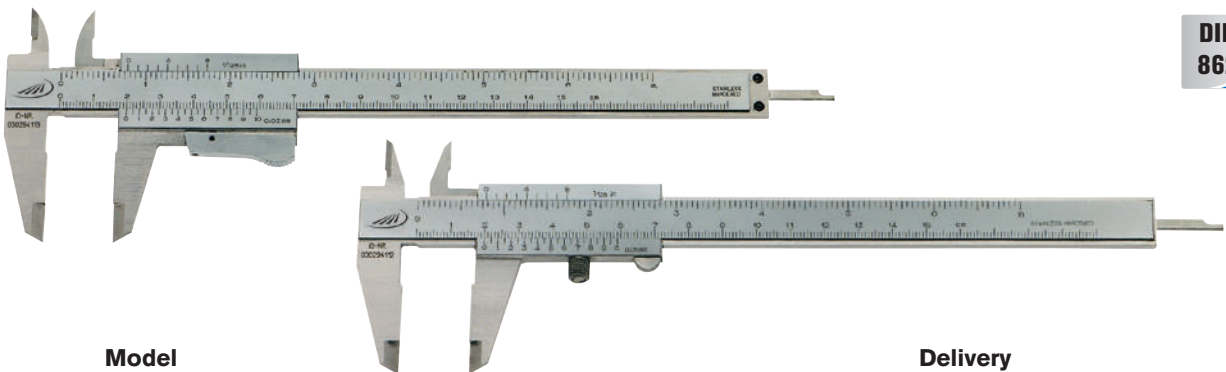

### Model

- **Parallax-free reading**
- Stainless steel
- Reading parts have a satin chrome finish
- DIN 862

### Delivery

- Imitation leather case

DIN 862	Measuring range		Jaw length		Reading		Error limit	Depth gauge	Order no.	List price
	mm	inch	mm	inch	mm	inch				
<b>With thumb clamp</b>										
	0 - 150	0 - 6	40	1.6	0.05	1/128	0.05	rectangular	0198 501	30.50
<b>With locking screw</b>										
	0 - 150	0 - 6	40	1.6	0.05	1/128	0.05	rectangular	0199 501	30.50



## 0190 Pocket vernier caliper DUO-FIX



DIN  
862

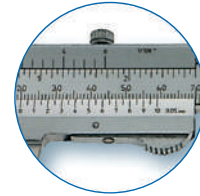
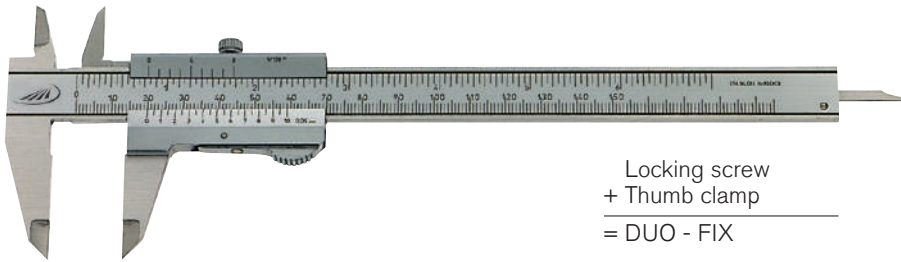

Locking screw  
+ Thumb clamp  
= DUO - FIX

### Model

- Stainless steel
- Reading parts have a satin chrome finish
- DIN 862
- Thumb clamp **and** locking screw
- Inside cross points
- Low-set master scale
- Four way measurement
- Includes thread table

### Delivery

- Imitation leather case

✕	📏	Measuring range		Jaw length		Reading		Error limit	Depth gauge	Order no.	List price
		mm	inch	mm	inch	mm	inch	mm			EUR
		0 - 150	0 - 6	40	1.6	0.05	1/128	0.05	rectangular	0190 501	27.00

## 0203 Precision pocket vernier caliper PRISMA



DIN  
862

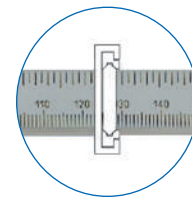

### Model

- **Parallax-free reading**
- **Double prisma guide with excellent sliding characteristics**
- Stainless steel
- Reading parts have a satin chrome finish
- DIN 862
- Low-set locking screw
- Inside cross points
- Four way measurement
- Includes thread table

### Delivery

- Imitation leather case

✕	📏	Measuring range		Jaw length		Reading		Error limit	Depth gauge	Order no.	List price
		mm	inch	mm	inch	mm	inch	mm			EUR
		0 - 150	0 - 6	40	1.6	0.05	1/128	0.05	rectangular	0203 501	52.00



## 0182 Pocket vernier caliper for lefthanded

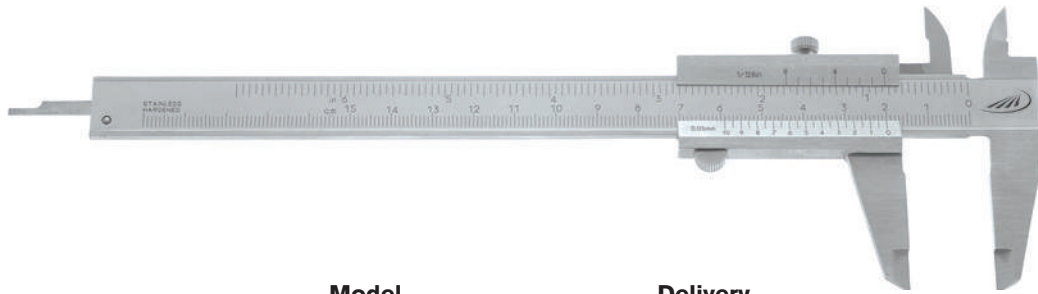

1

### Model

- Stainless steel
- Reading parts have a satin chrome finish
- Locking screw
- Factory standard

### Delivery

- Imitation leather case

Icon	Measuring range		Jaw length		Reading		Error limit	Depth gauge	Order no.	List price
	mm	inch	mm	inch	mm	inch				
With locking screw	0 - 150	0 - 6	40	1.6	0.05	1/128	0.05	rectangular	0182 501	34.50

## 0261 Shaft distance caliper

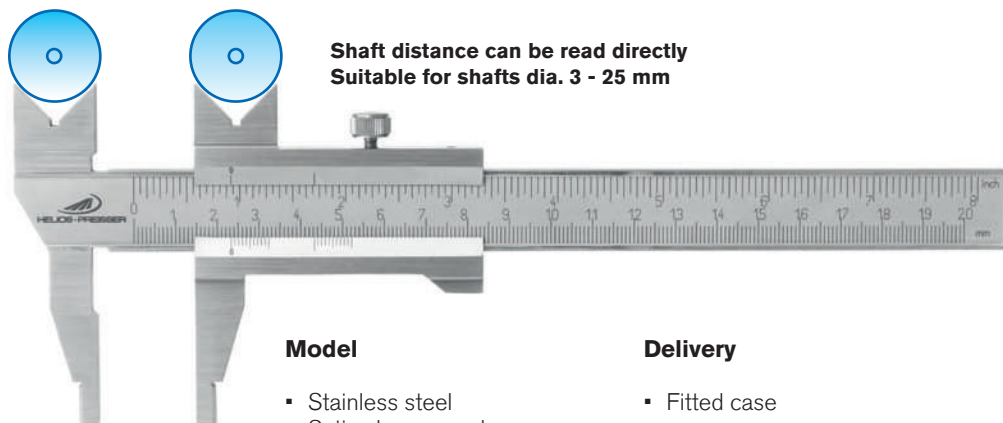

### Model

- Stainless steel
- Satin chrome scale
- Factory standard
- Main intervals are located deeper
- Stepped jaws for inside measurement: 10 mm

### Delivery

- Fitted case

Icon	Measuring range		Jaw length	Reading	Order no.	List price
	mm	inch	mm	mm		
	0 - 150	0 - 6	40	0.1	0261 516	224.00



## 0180 Pocket caliper



### Model

- Made from hard brass
- Factory standard

### Delivery

- Cardboard box

	Measuring range		Jaw length		Reading		Order no.	List price
	mm	inch	mm	inch	mm	inch		
	0 - 100	0 - 6	25	1.0	0.1	1/16	0180 320	EUR 7.10

## 0180 Pocket caliper



### Model

- Made from hard brass
- Stepped jaw 5 mm for internal measurement
- Factory standard

### Delivery

- Cardboard box

	Measuring range		Jaw length		Reading		Order no.	List price
	mm	inch	mm	inch	mm	inch		
	0 - 100	0 - 6	25	1.0	0.1	1/16	0180 330	EUR 7.10

## 0180 Tyre profile depth gauge



### Model

- Made from hard brass
- Factory standard

### Delivery

- Cardboard box

	Measuring range		Jaw length		Reading		Order no.	List price
	mm	inch	mm	inch	mm	inch		
	0 - 30	0 - 1.18	30	1.2	0.1	1/16	0180 310	EUR 4.40



## 0217 / 0218 Dial calipers



DIN  
862

1

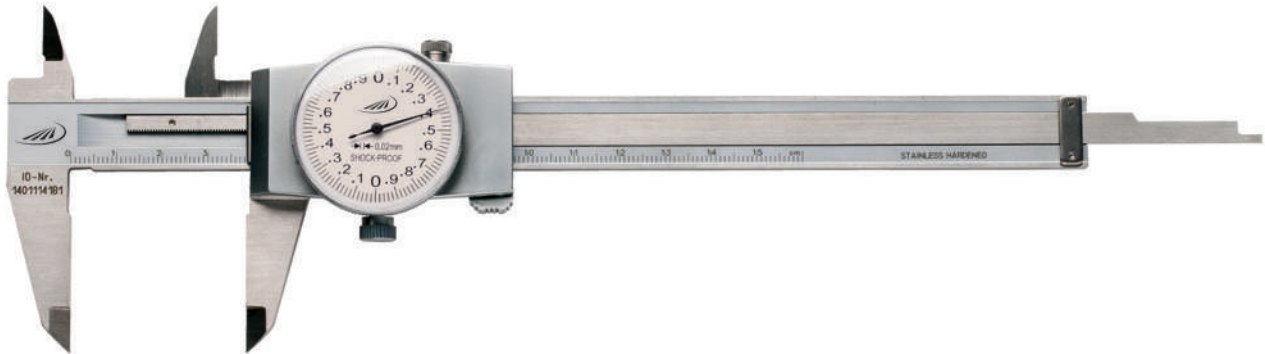

### Model

- Stainless steel
- Satin chrome scale
- DIN 862
- Locking screw
- Inside cross points

### Delivery

- One pointer revolution with 0217 = 2 mm with 0218 = 1 mm
- Four way measurement
- Fitted case

☒	Measuring range		Jaw length		Reading	Error limit	Depth gauge	Order no.	List price
	mm	inch	mm	inch	mm	mm			EUR
▪	0 - 150	0 - 6	40	1.6	0.02	0.03	rectangular	0217 501	67.00
▪	0 - 200	0 - 8	40	1.6	0.02	0.03	rectangular	0217 502	135.00
▪	0 - 150	0 - 6	40	1.6	0.01	0.03	rectangular	0218 501	90.00



## 0212 Quality measuring tool set, 8 piece



**INCLUDING  
ONE POCKET CALIPER  
OF YOUR CHOICE**

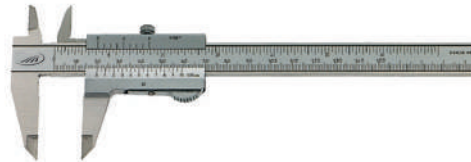

### Content

- Pocket calipers in 5 different types of choice
- External micrometer with carbide measuring faces, measuring range 0-25 mm, reading 0.01 mm
- Flexible steel rule, stainless steel, measuring range 200 mm, graduation mm / mm, 13 x 0.5 mm
- Knife square, hardened, DIN 875/00, 100 x 70 mm, with non-glare knife edge
- Knife edge, hardened and ground, DIN 874/00, length 100 mm
- Scriber, carbide tipped, hexagonal handle made of one piece, with pocket clip, length 180 mm
- Radius gauge, special steel, 17 sheets, concave and convex, with locking nut, measuring range 1.0 – 7.0 mm
- Screw pitch gauge, combined metric ISO- and Whitworth thread, 48 blades, increments 0.4 – 7.0 / 4 – 62

### ▪ Shipment

- Wooden case

☒	☒	Measuring range mm	Ableitung mm	Ableitung inch	Tiefenmaß mm	Best. Nr.	Listenpreis EUR
<b>Set mit Taschenmessschieber DUO - FIX (0190 501)</b>							
		0 - 150	0.05	1/128	rect.	0212 520	133.00
<b>Set mit DIGI-MET® Taschenmessschieber (1320 416 / 417)</b>							
		0 - 150	0.01	.0005	rund 1.5	0212 522	195.00
		0 - 150	0.01	.0005	rect.	0212 524	195.00
<b>Set mit DIGI-MET® Taschenmessschieber IP67 (1326 416 / 417)</b>							
		0 - 150	0.01	.0005	rund 1.5	0212 526	219.00
		0 - 150	0.01	.0005	rect.	0212 528	219.00



## DIGI-MET® QuickStart Electronic



### QuickStart-Electronic with the QuickLock-Function for only one zero setting

All digital calipers with the QuickStart-Electronic also have the **QuickLock** Function. Only set the zero position once, zero position remains stored for all further measurements. When the **QuickLock** Function is activated a lock symbol appears in the display, this ensures that the zero position is protected against any operating error caused by accidental usage of the operating keys (keys are locked). The caliper is immediately ready for measurement; once the caliper is switched ON or the slide is moved, the display is automatically activated.

The need to reset to zero as with a conventional caliper once it is switched on is obsolete.

1

### Conventional

- ① Switch ON
- ② Close the measuring jaws
- ③ Set to zero
- ④ Result of measurement

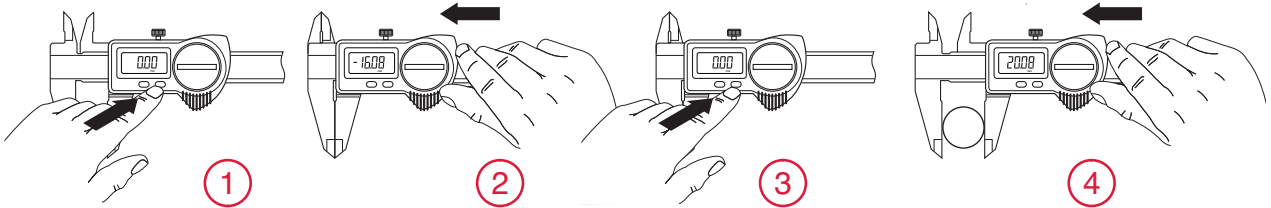

### QuickStart Electronic

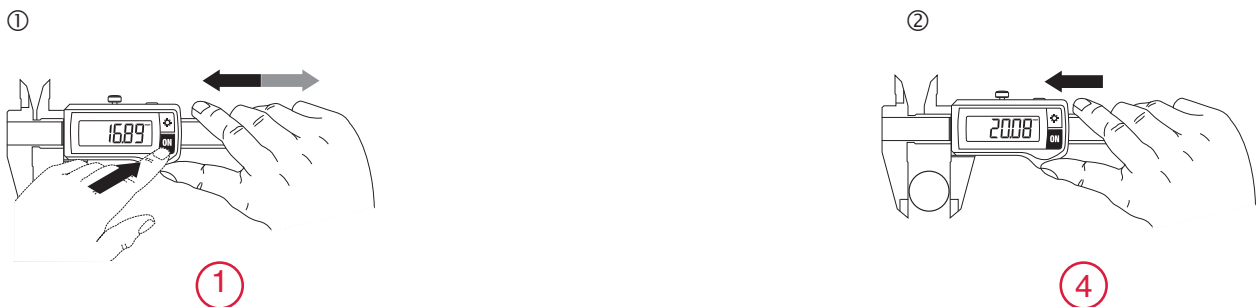

Press the ON key or move the slide

## DIGI-MET® QuickLock-Function



- 1. Set to zero
- 2. Activate the QuickLock Function

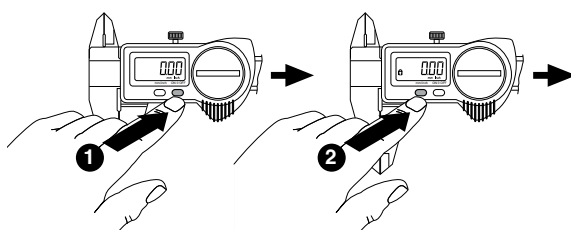

### Advantages of the QuickLock Function

- The caliper is immediately ready for measurement
- Lock symbol appears in the display. This ensures that the zero position is protected against any operating error caused by accidental usage of the operating keys (keys are locked)





## 1326i DIGI-MET® Pocket calipers IP67 with integrated wireless

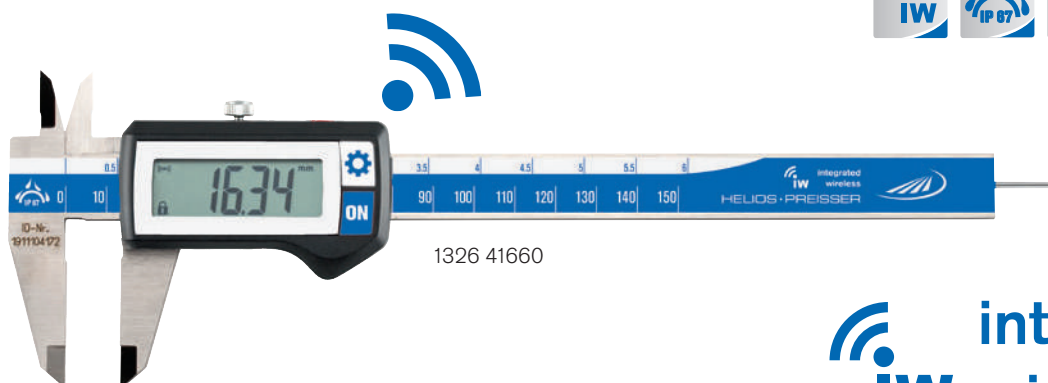

1326 41660

## integrated IW wireless

Wireless Data Transmission

### Model

- Measuring system is insensitive to cooling agents and dust
- Protection class IP67
- Stainless steel
- LCD display 11 mm
- DIN 862
- Housing and operating keys have an excellent chemical resistance
- Locking screw
- Inside cross points
- Four way measurements

### Functions

- ON / OFF
- Quick-Start**
- Quick-Lock** (key lock)
- Set to zero at any point
- mm / inch switching
- PRESET-Function (setting a numerical value)
- Integrated Wireless

### Delivery

- Plastic case



More information on our i-series and Integrated Wireless on page

✕	Measuring range		Jaw length		Reading		Error limit	Depth gauge	Order no.	List price
	mm	inch	mm	inch	mm	inch				
▪	0 - 150	0 - 6	40	1.6	0.01	.0005	0.03	round 1.5	1326 41660	218.00
▪	0 - 150	0 - 6	40	1.6	0.01	.0005	0.03	rectangular	1326 41760	218.00
▪	0 - 200	0 - 8	50	2.0	0.01	.0005	0.03	rectangular	1326 41860	279.00
▪	0 - 300	0 - 12	65	2.5	0.01	.0005	0.03	none	1326 42260	337.00



1998780

### Accessories

	Order no.	List price
Battery, 3V-Lithium, CR 2032	0220 704	3.90
i-Stick USB-receiver for Integrated Wireless	1998 780	95.00

Integrated Wireless is intended to be sold within the European Economic Area only



## 1320 DIGI-MET® Pocket calipers



1320 416



1320 517



### Model

- Inductive measuring system, resistant to moisture and sweat
- Stainless steel
- LCD display 11 mm without data output, 7.5 mm with data output
- DIN 862
- Locking screw
- Inside cross points

- Four way measurement with measuring ranges 150 and 200 mm
- Three way measurement with measuring range 300 mm

### Functions

- ON / OFF
- **Quick-Start**
- **Quick-Lock** (key lock)
- Set to zero at any point
- mm / inch switching
- **PRESET-Function** (setting a numerical value)

### Delivery

- Plastic case



Video electronic

▶	Measuring range		Jaw length		Reading		Error limit	Depth gauge	Order no.	List price EUR
	mm	inch	mm	inch	mm	inch				
<b>Without data output</b>										
▪	0 - 150	0 - 6	40	1.6	0.01	.0005	0.03	round 1.5	1320 416	110.00
▪	0 - 150	0 - 6	40	1.6	0.01	.0005	0.03	rectangular	1320 417	110.00
<b>With DATA VARIABLE</b>										
▪	0 - 150	0 - 6	40	1.6	0.01	.0005	0.03	round 1.5	1320 516	145.00
▪	0 - 150	0 - 6	40	1.6	0.01	.0005	0.03	rectangular	1320 517	145.00
▪	0 - 200	0 - 8	50	2.0	0.01	.0005	0.03	rectangular	1320 519	185.00
▪	0 - 300	0 - 12	65	2.5	0.01	.0005	0.03	none	1320 522	235.00
<b>With DATA VARIABLE, with extra long cross points (40 mm)</b>										
▪	0 - 150	0 - 6	40	1.6	0.01	.0005	0.03	round 1.5	1320 518	395.00

More information on 1320 518 on page 58



1998720

1998501

1997501

### Accessories

	Order no.	List price EUR
Battery, 3V-Lithium, CR 2032	0220 704	3.90
Data cable DATA VARIABLE to digimatic	1998 501	64.00
Data cable DATA VARIABLE to RS232	1997 501	50.00
Data cable DATA VARIABLE to USB	1998 720	72.00



## 1326 DIGI-MET® Pocket calipers IP67



DIN  
862

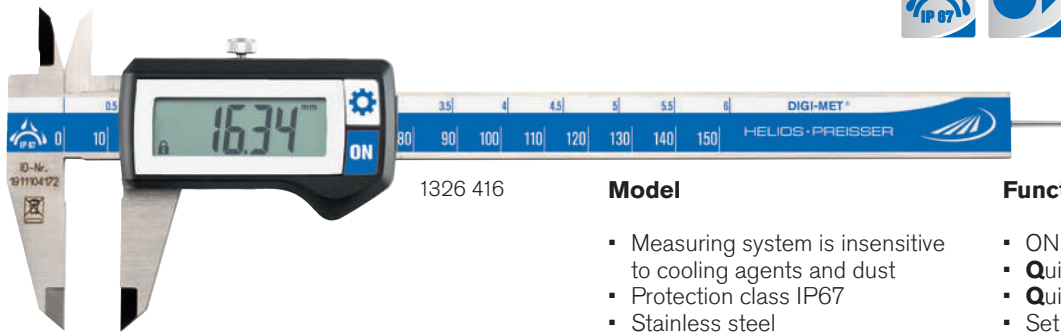

1326 416

### Model

- Measuring system is insensitive to cooling agents and dust
- Protection class IP67
- Stainless steel
- LCD display 11 mm
- DIN 862
- Housing and operating keys have an excellent chemical resistance
- Locking screw
- Inside cross points
- Four way measurement with measuring ranges 150 and 200 mm
- Three way measurement with measuring range 300 mm

### Functions

- ON / OFF
- Quick-Start**
- Quick-Lock** (key lock)
- Set to zero at any point
- mm / inch switching
- PRESET-Function (setting a numerical value)

### Delivery

- Plastic case



Video  
electronic

✕	🏠	Measuring range		Jaw length		Reading		Error limit mm	Depth gauge	Order no.	List price EUR
		mm	inch	mm	inch	mm	inch				
▪		0 - 150	0 - 6	40	1.6	0.01	.0005	0.03	round 1.5	1326 416	159.00
▪		0 - 150	0 - 6	40	1.6	0.01	.0005	0.03	rectangular	1326 417	159.00
▪		0 - 200	0 - 8	50	2.0	0.01	.0005	0.03	rectangular	1326 418	225.00
▪		0 - 300	0 - 12	65	2.5	0.01	.0005	0.03	none	1326 422	285.00

### With carbide-tipped measuring jaws

▪		0 - 150	0 - 6	40	1.6	0.01	.0005	0.03	round 1.5	1326 914	343.00
---	--	---------	-------	----	-----	------	-------	------	-----------	----------	--------

### Accessories

Battery, 3V-Lithium, CR 2032

### Order no.

0220 704

### List price

EUR

3.90

## 0220 Additional depth measuring base

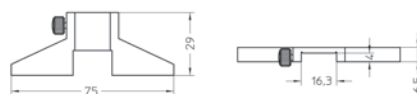
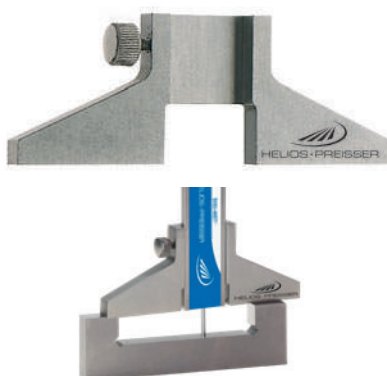

### Model

- Stainless steel
- Bridge length: 75 mm
- Dimensions: 75 x 6.5 mm

✕	🏠	Order no.	List price EUR
		0220 705	22.40



# HELIOS · PREISSER

## 1326 DIGI-MET® Pocket calipers IP67 with data output

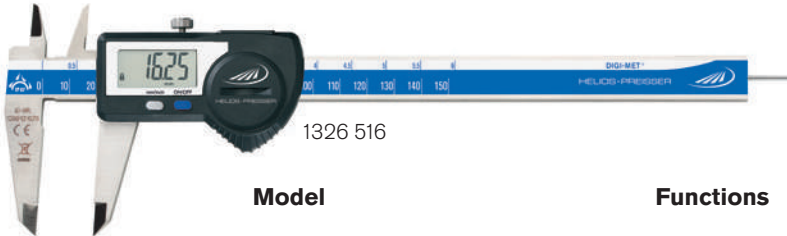

1326 516



### Model

- Measuring system is insensitive to cooling agents and dust
- Protection class IP67
- Stainless steel
- LCD display 7.5 mm
- DIN 862
- Locking screw
- Inside cross points
- Four way measurement

### Functions

- ON / OFF
- Quick-Start**
- Quick-Lock** (key lock)
- Set to zero at any point
- mm / inch switching
- Variable data output RS 232 + Digimatic + USB

### Delivery

- Plastic case

▣	Measuring range		Jaw length		Reading		Error limit	Depth gauge	Order no.	List price
	mm	inch	mm	inch	mm	inch	mm			EUR
▣	0 - 150	0 - 6	40	1.6	0.01	.0005	0.03	round 1.5	1326 516	159.00
▣	0 - 150	0 - 6	40	1.6	0.01	.0005	0.03	rectangular	1326 517	159.00
▣	0 - 200	0 - 8	50	2.0	0.01	.0005	0.03	rectangular	1326 518	235.00



### Accessories

	Order no.	List price
		EUR
Battery, 3V-Lithium, CR 2032	0220 704	3.90
Data cable DATA VARIABLE to RS232	1997 501	50.00
Data cable DATA VARIABLE to digimatic	1998 501	64.00
Data cable DATA VARIABLE to USB	1998 720	72.00

## 1322 DIGI-MET® Pocket caliper PRISMA



### Model

- Double prisma guide with excellent sliding characteristics
- Protection class IP67
- Stainless steel
- DIN 862
- LCD display 7.5 mm
- Locking screw
- Inside cross points
- Four way measurement

### Functions

- ON / OFF
- Set to zero at any point
- mm / inch switching
- Quick-Start**
- Quick-Lock** (key lock)
- Variable data output RS 232 + Digimatic + USB

### Delivery

- Wooden case

▣	Measuring range		Jaw length		Reading		Error limit	Depth gauge	Order no.	List price
	mm	inch	mm	inch	mm	inch	mm			EUR
▣	0 - 150	0 - 6	40	1.6	0.01	.0005	0.03	round 1.5	1322 516	212.00

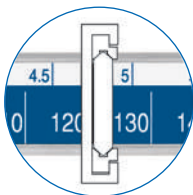



## 1998 / 0996 / 1997 Data cable

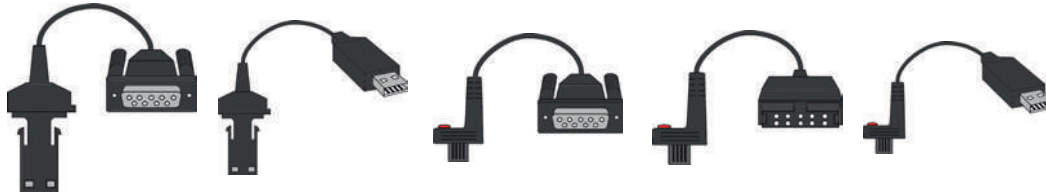

0996 701

0996 705

1997 501

1998 501

1998 720

### Model

- Length 2 m
- For use with MarCom Professional software to transfer the measured results to PC, laptop or workstation

Model	Description	Order no.	List price EUR
0996 701	Cable Opto for RS232	0996 701	77.00
0996 705	Cable Opto for USB	0996 705	147.00
1997 501	Cable DataVariable for RS232	1997 501	50.00
1998 501	Cable DataVariable for Digimatic	1998 501	64.00
1998 720	Cable DataVariable for USB	1998 720	72.00

## 0145 Measuring tool set >>Extensions<<



### Model

- Pairs of measuring inserts, disc dia. 6 / 10 / 12.5 mm
- Pair of measuring inserts with 60° cone, dia. 9 / 12.5 mm
- Pair of measuring inserts with cylindrical surfaces 1.5 mm
- Insert holder, right / left with thread M 2.5
- Allen wrench SW 1.2 mm
- For digital pocket calipers with max. jaw thickness of 3.5 mm

### Delivery

- Wooden box

Model	Description	Order no.	List price EUR
0145 110	Measuring tool set, 14 pieces	0145 110	171.00



Measure distances between bore holes

Measure grooves

Measure distances

Measure distances between bore holes

Measure grooves



## 1326 Universal pocket caliper „Pocket Talent“



Incl. setting standard

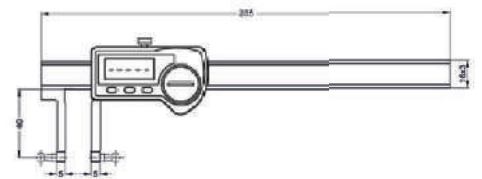

### Model

- Stainless steel
- Protection class IP67
- Factory standard
- LCD display 7.5 mm
- Locking screw
- For internal and external measurements
- Individually adaptable on problematic tasks through measuring inserts with thread M 2.5

### Functions

- ON / OFF
- **Quick-Start**
- **Quick-Lock** (key lock)
- Set to zero at any point
- mm / inch switching
- PRESET-Function (setting a numerical value)
- Variable data output RS 232 + Digimatic + USB

### Delivery

- Wooden box
- Measuring inserts No. 0710161\* and 0710177\*  
Planar surface Ø 4.8 mm /  
Ball inserts Ø 5.0 mm
- Setting standard

Models with measuring range 300 and 500 mm on page 56

Icon	Measuring range		Jaw length	Reading		Order no.	List price
	mm	inch		mm	mm		
	0 - 150	0 - 6	40	0.01	.0005	1326 932	359.00

Our all-round talent can be combined with all common types of measuring inserts for indicators with a standard M 2.5 thread. This way, the Pocket Talent offers you various solutions for numerous measurement applications.

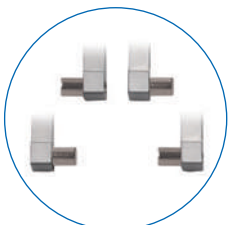

0710161\*

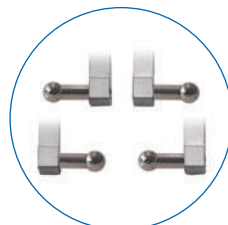

0710177\*

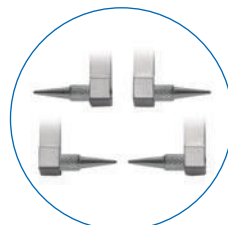

0710166

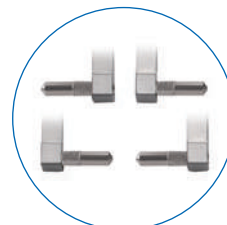

0710167

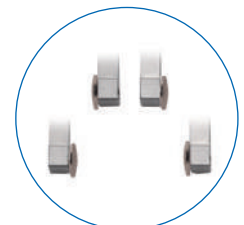

0710163



1998720



1998501



1997501



Product video

### Accessories

Accessories	Order no.	List price
		EUR
Battery, 3V-Lithium, CR 2032	0220 704	3.90
Measuring inserts M 2.5	0710 161	3.60
Measuring inserts M 2.5	0710 163	5.40
Measuring inserts M 2.5	0710 166	4.90
Measuring inserts M 2.5	0710 167	3.40
Measuring inserts M 2.5	0710 177	6.80
Setting standard for Pocket Talent	1326 990	39.00
Data cable DATA VARIABLE to RS232	1997 501	50.00
Data cable DATA VARIABLE to digimatic	1998 501	64.00
Data cable DATA VARIABLE to USB	1998 720	72.00



= QuickLock



= QuickStart



= Waterproof acc. IP



= Data output



= DIN



## 1326 DIGI-MET® Pocket calipers for specific measuring tasks

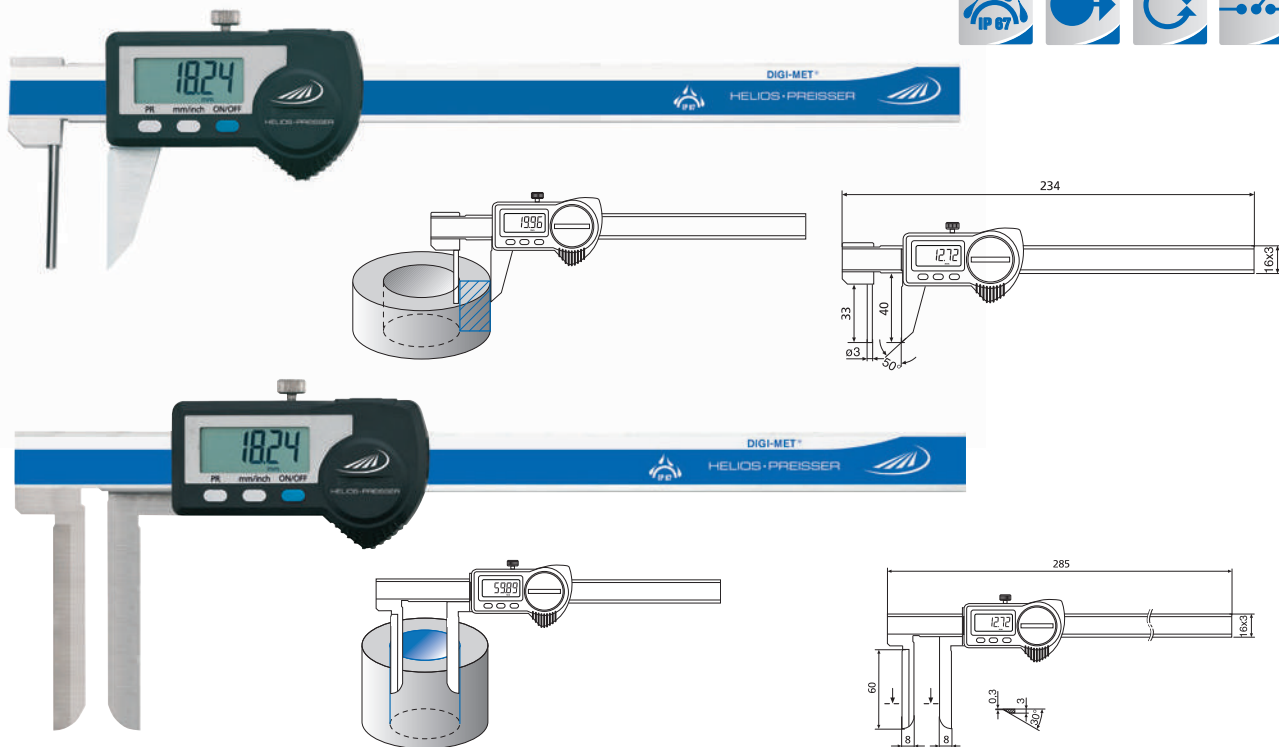

### Model

- Protection class IP67
- Stainless steel
- LCD display 7.5 mm
- Factory standard
- Measuring system is insensitive to cooling agents and dust

- Housing and operating keys have an excellent chemical resistance
- Inside cross points
- Locking screw

### Functions

- ON / OFF
- Quick-Start
- Quick-Lock (key lock)
- Set to zero at any point
- mm / inch switching
- PRESET-Function (setting a numerical value)
- Variable data output RS 232 + Digimatic + USB

### Delivery

- Wooden case

Icon	Measuring range		Jaw length		Reading		Order no.	List price EUR
	mm	inch	mm	inch	mm	inch		
	0 - 150	0 - 6	40	1.6	0.01	.0005	1326 918	503.00
	10 - 200	0.4 - 8	60	2.4	0.01	.0005	1326 930	653.00

### Accessories



Accessories	Order no.	List price EUR
Battery, 3V-Lithium, CR 2032	0220 704	3.90
Data cable DATA VARIABLE to RS232	1997 501	50.00
Data cable DATA VARIABLE to digimatic	1998 501	64.00
Data cable DATA VARIABLE to USB	1998 720	72.00



# HELIOS · PREISSER

## 1326 DIGI-MET® Pocket calipers for specific measuring tasks

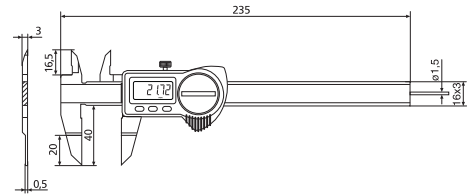
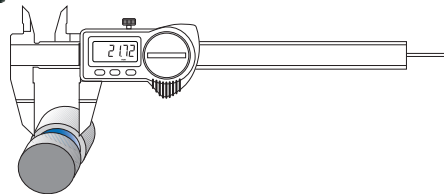
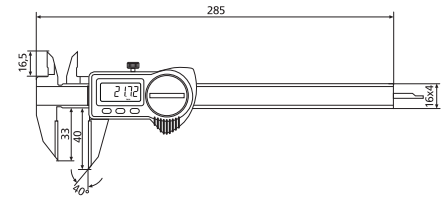
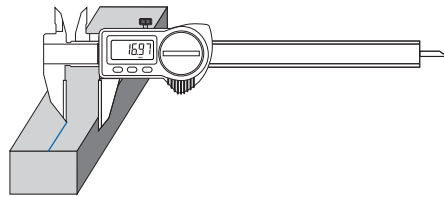
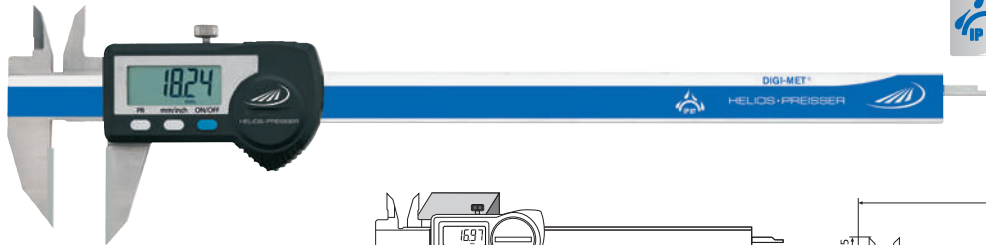

### Model

- Protection class IP67
- Stainless steel
- LCD display 7,5 mm
- Factory standard
- Measuring system is insensitive to cooling agents and dust

- Housing and operating keys have an excellent chemical resistance
- Inside cross points
- Locking screw

### Functions

- ON / OFF
- Quick-Start
- Quick-Lock (key lock)
- Set to zero at any point
- mm / inch switching
- PRESET-Function (setting a numerical value)
- Variable data output RS 232 + Digimatic + USB

### Delivery

- Wooden case

Icon	Measuring range		Jaw length		Reading		Depth gauge	Order no.	List price EUR
	mm	inch	mm	inch	mm	inch			
<b>Scribing caliper with carbide-tipped outer measuring surfaces</b>									
	0 - 200	0 - 8	33	1.3	0.01	.0005	rectangular	1326 912	320.00
<b>With flat measuring surfaces e.g. for outer recesses</b>									
	0 - 150	0 - 6	40	1.6	0.01	.0005	round 1.5	1326 920	545.00

### Accessories



	Order no.	List price EUR
Battery, 3V-Lithium, CR 2032	0220 704	3.90
Data cable DATA VARIABLE to RS232	1997 501	50.00
Data cable DATA VARIABLE to digimatic	1998 501	64.00
Data cable DATA VARIABLE to USB	1998 720	72.00





## 1326 DIGI-MET® Pocket calipers for specific measuring tasks

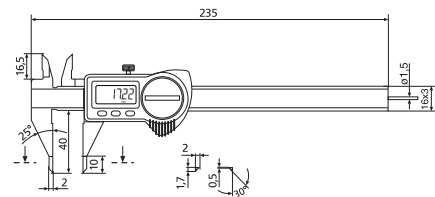
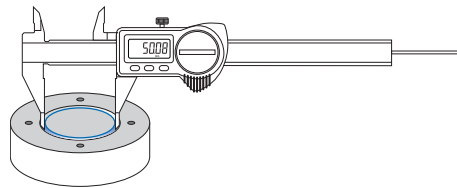
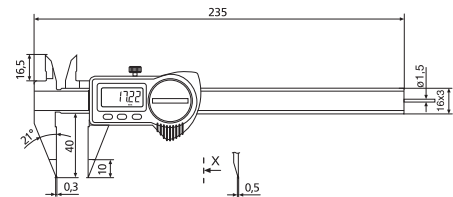
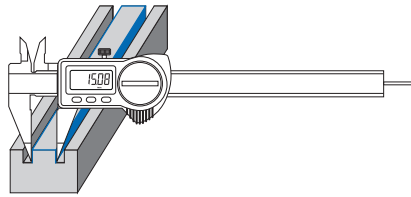

### Model

- Protection class IP67
- Stainless steel
- LCD display 7.5 mm
- Factory standard
- Measuring system is insensitive to cooling agents and dust

- Housing and operating keys have an excellent chemical resistance
- Inside cross points
- Locking screw

### Functions

- ON / OFF
- Quick-Start
- Quick-Lock (key lock)
- Set to zero at any point
- mm / inch switching
- PRESET-Function (setting a numerical value)
- Variable data output RS 232 + Digimatic + USB

### Delivery

- Wooden case

Measuring range	Jaw length		Reading		Order no.	List price EUR
	mm	inch	mm	inch		
<b>With pointed jaws</b>						
0 - 150	0 - 6	40	1.6	0.01	.0005	1326 916 396.00
<b>With fine measuring tips</b>						
0 - 150	0 - 6	40	1.6	0.01	.0005	1326 922 447.00



1998720

1998501

1997501

### Accessories

	Order no.	List price EUR
Battery, 3V-Lithium, CR 2032	0220 704	3.90
Data cable DATA VARIABLE to RS232	1997 501	50.00
Data cable DATA VARIABLE to digimatic	1998 501	64.00
Data cable DATA VARIABLE to USB	1998 720	72.00



# HELIOS · PREISSER

## 1326 DIGI-MET® Pocket calipers for specific measuring tasks

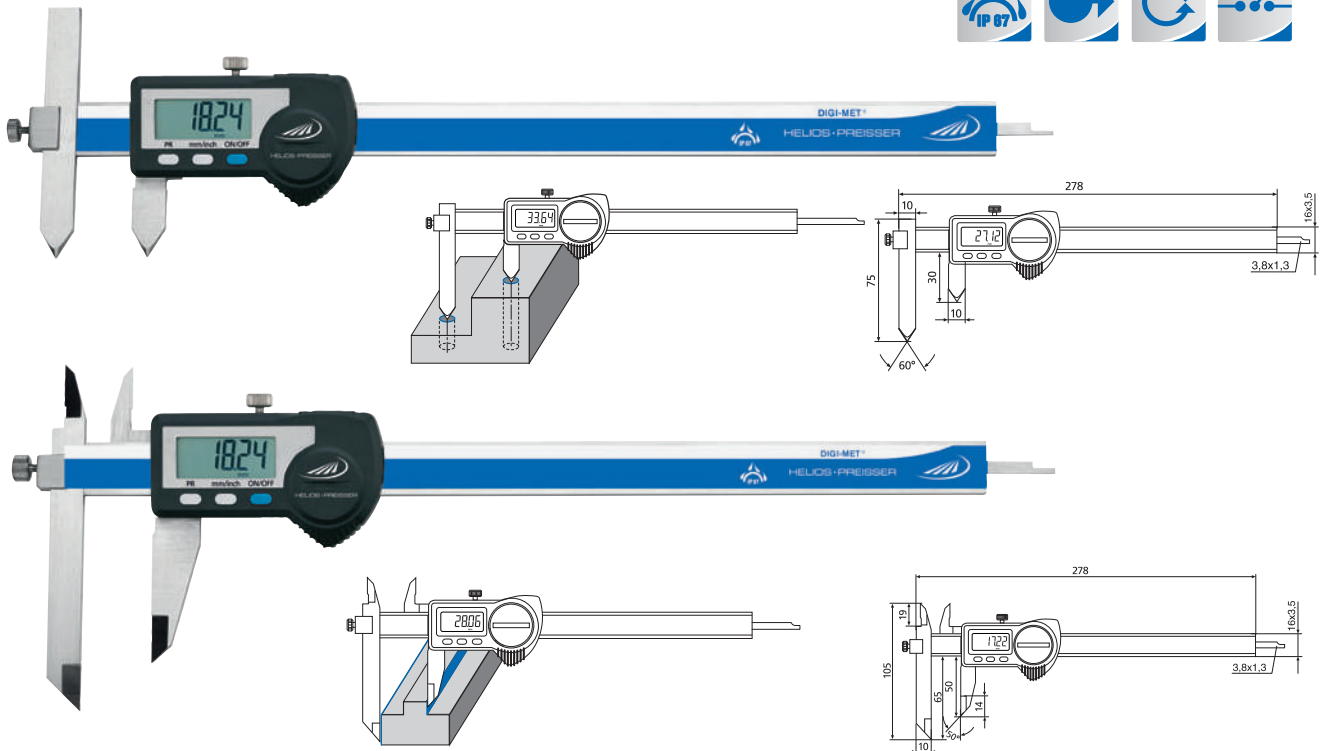

1

### Model

- Protection class IP67
- Stainless steel
- LCD display 7.5 mm
- Factory standard
- Measuring system is insensitive to cooling agents and dust

- Housing and operating keys have an excellent chemical resistance
- Inside cross points
- Locking screw

### Functions

- ON / OFF
- Quick-Start**
- Quick-Lock** (key lock)
- Set to zero at any point
- mm / inch switching
- PRESET-Function (setting a numerical value)
- Variable data output RS 232 + Digimatic + USB

### Delivery

- Wooden case

Icon	Measuring range		Jaw length		Reading		Order no.	List price EUR
	mm	inch	mm	inch	mm	inch		
	<b>Moving jaws for measuring the distance between bores</b>							
	10 - 210	0.4 - 8.3	75	3.0	0.01	.0005	1326 924	443.00
	<b>Moving jaws + cross tips</b>							
	0 - 200	0 - 8	65	2.5	0.01	.0005	1326 928	476.00



1998720

1998501

1997501

### Accessories

	Order no.	List price EUR
Battery, 3V-Lithium, CR 2032	0220 704	3.90
Data cable DATA VARIABLE to RS232	1997 501	50.00
Data cable DATA VARIABLE to digimatic	1998 501	64.00
Data cable DATA VARIABLE to USB	1998 720	72.00



## 1326 DIGI-MET® Pocket calipers for specific measuring tasks

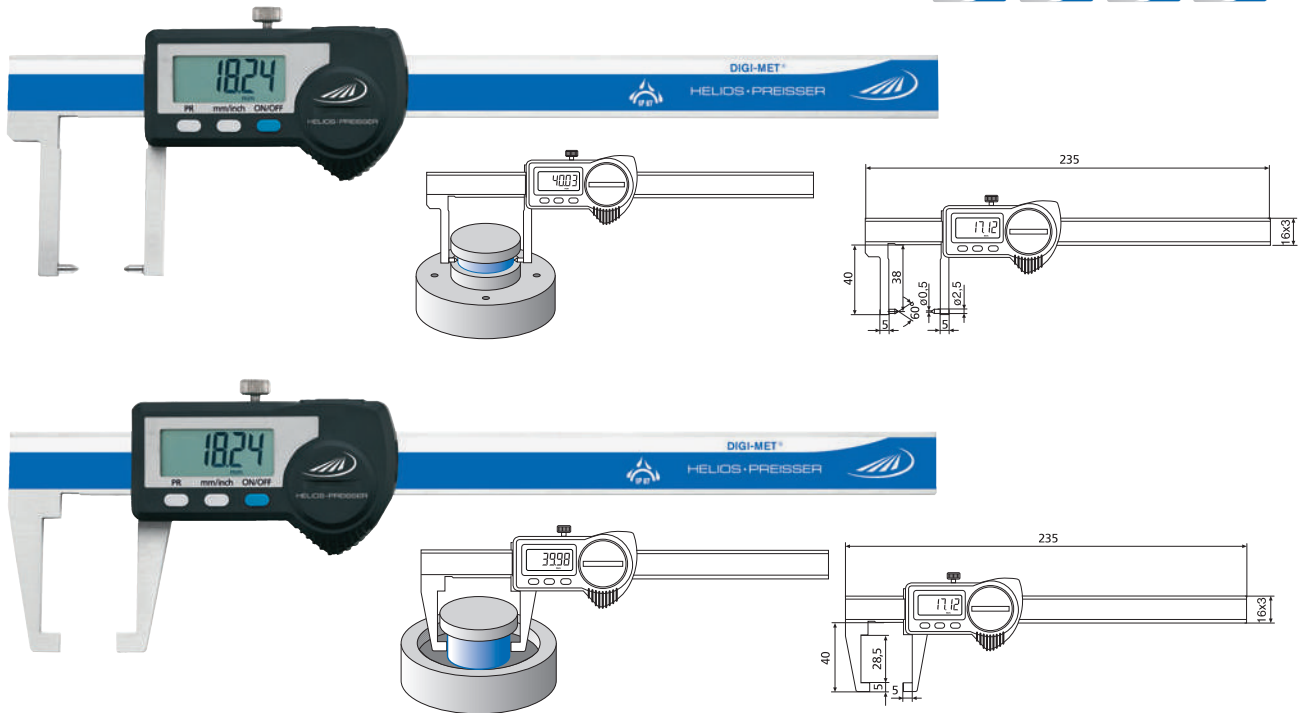

### Model

- Protection class IP67
- Stainless steel
- LCD display 7.5 mm
- Factory standard
- Measuring system is insensitive to cooling agents and dust

- Housing and operating keys have an excellent chemical resistance
- Inside cross points
- Locking screw

### Functions

- ON / OFF
- Quick-Start
- Quick-Lock (key lock)
- Set to zero at any point
- mm / inch switching
- PRESET-Function (setting a numerical value)
- Variable data output RS 232 + Digimatic + USB

### Delivery

- Wooden case

Measuring tips angled inwards	Measuring range		Jaw length		Reading		Order no.	List price EUR
	mm	inch	mm	inch	mm	inch		
	0 - 150	0 - 6	40	1.6	0.01	.0005	1326 904	573.00
Measuring jaws angled inwards								
	0 - 150	0 - 6	40	1.6	0.01	.0005	1326 908	489.00

### Accessories



1998720

1997501

1998501

Battery, 3V-Lithium, CR 2032

data cable DATA VARIABLE to RS232

data cable DATA VARIABLE to digimatic

data cable DATA VARIABLE to USB

Order no.

0220 704

1997 501

1998 501

1998 720

List price EUR

3.90

50.00

64.00

72.00



# HELIOS · PREISSER

## 1326 DIGI-MET® Pocket calipers for specific measuring tasks

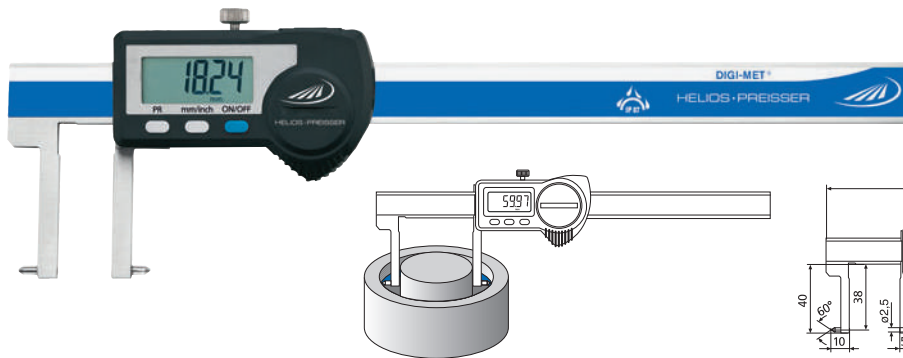

### Model

- Protection class IP67
- Stainless steel
- LCD display 7.5 mm
- Factory standard
- Measuring system is insensitive to cooling agents and dust

- Housing and operating keys have an excellent chemical resistance
- Inside cross points
- Locking screw

### Functions

- ON / OFF
- Quick-Start
- Quick-Lock (key lock)
- Set to zero at any point
- mm / inch switching
- PRESET-Function (setting a numerical value)
- Variable data output RS 232 + Digimatic + USB

### Delivery

- Wooden case

Measuring tips angled outwards	Measuring range		Jaw length		Reading		Order no.	List price EUR
	mm	inch	mm	inch	mm	inch		
Measuring tips angled outwards	20.5 - 170	0.8 - 6.7	40	1.6	0.01	.0005	1326 906	568.00
Measuring jaws angled outwards	10.5 - 160	0.4 - 6.3	40	1.6	0.01	.0005	1326 910	562.00

### Accessories



	Order no.	List price EUR
Battery, 3V-Lithium, CR 2032	0220 704	3.90
Data cable DATA VARIABLE to RS232	1997 501	50.00
Data cable DATA VARIABLE to digimatic	1998 501	64.00
Data cable DATA VARIABLE to USB	1998 720	72.00



## 0633 Steel gauge block inspection set for calipers



### Model

- EN ISO 3650
- Special steel, hardened
- Tolerance class 1
- Supplied with: setting rings 4 mm and 25 mm

### Delivery

- Wooden box

	For measuring range mm	Max. nominal size mm	Order no.	List price EUR
<b>3 pieces</b>	200	30.0 / 41.3 / 131.4	0633 833	563.00
<b>4 pieces</b>	300	30.0 / 41.3 / 131.4 / 243.5	0633 834	751.00
<b>6 pieces</b>	500	30.0 / 41.3 / 131.4 / 243.5 / 281.2 / 481.1	0633 836	1341.00
<b>5 pieces</b>	1000	131.4 / 243.5 / 281.2 / 481.1 / 900	0633 838	2371.00



## 0230 / 0231 Workshop calipers with parallax-free reading



DIN 862

1

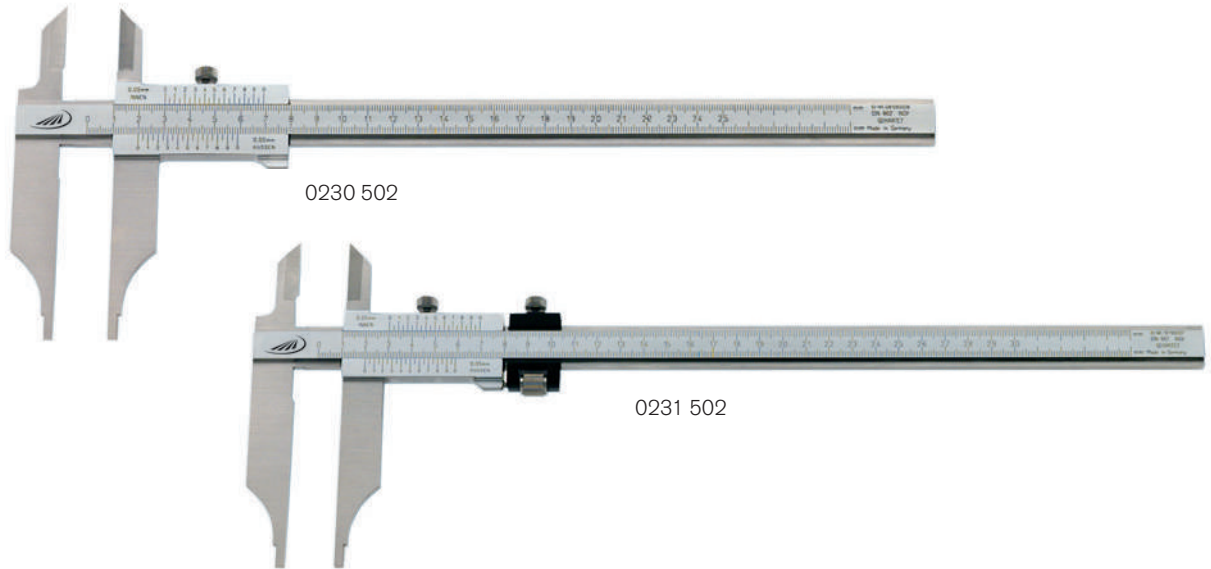

### Model

- Parallax-free reading
- Stainless steel
- Reading parts have a satin chrome finish
- DIN 862
- Locking screw
- Knife points

### Delivery

- Stepped jaws for inside measurement: 10 mm, for measuring range 500 mm: 20 mm
- Direct reading of internal and external measurements
- High-precision laser graduation on vernier and scale
- Cardboard box

☒	Measuring range		Jaw length		Reading	Error limit	Order no.	List price
	mm	inch	mm	inch				
<b>Without fine adjustment</b>								
▪	0 - 200	0 - 8	80	3.0	0.05	0.05	0230 501	146.00
▪	0 - 250	0 - 10	80	3.0	0.05	0.05	0230 502	163.00
▪	0 - 300	0 - 12	90	3.5	0.05	0.05	0230 503	178.00
▪	0 - 500	0 - 20	150	6.0	0.05	0.07	0230 508	510.00
<b>With fine adjustment</b>								
▪	0 - 200	0 - 8	80	3.0	0.05	0.05	0231 501	173.00
▪	0 - 250	0 - 10	80	3.0	0.05	0.05	0231 502	190.00
▪	0 - 300	0 - 12	90	3.5	0.05	0.05	0231 503	205.00
▪	0 - 500	0 - 20	150	6.0	0.05	0.07	0231 508	557.00



## 0234 Workshop calipers



DIN  
862

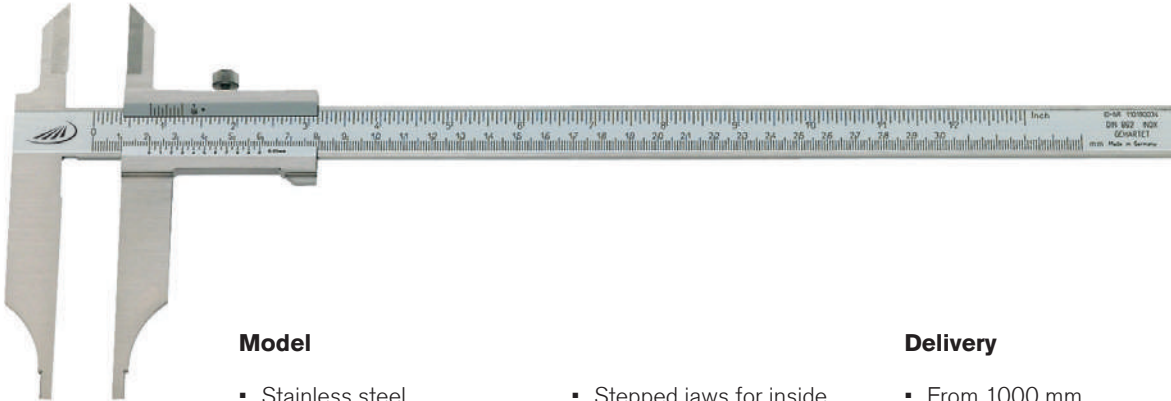

### Model

- Stainless steel
- Vernier and / or reading parts have a satin chrome finish
- DIN 862
- Locking screw
- Knife points

### Delivery

- From 1000 mm measuring range individually packed

✕	📏	Measuring range		Jaw length		Reading		Error limit mm	Order no.	List price EUR
		mm	inch	mm	inch	mm	inch			
<b>Vernier satin chrome finished</b>										
▪		0 - 200	0 - 8	80	3.0	0.05	1/128	0.05	0234 201	109.00
▪		0 - 250	0 - 10	80	3.0	0.05	1/128	0.05	0234 202	133.00
▪		0 - 300	0 - 12	90	3.5	0.05	1/128	0.05	0234 203	143.00
▪		0 - 400	0 - 16	125	5.0	0.05		0.06	0234 205*	334.00
▪		0 - 500	0 - 20	150	6.0	0.05		0.07	0234 208*	419.00
▪		0 - 600	0 - 24	150	6.0	0.05		0.08	0234 211*	490.00
▪		0 - 800	0 - 31	150	6.0	0.05		0.1	0234 214*	557.00
▪		0 - 1000	0 - 39	150	6.0	0.05		0.12	0234 218*	676.00
	▪	0 - 1250	0 - 49	200	8.0	0.05		0.16	0234 222**	1082.00
	▪	0 - 1500	0 - 59	200	8.0	0.05		0.18	0234 224**	1398.00
	▪	0 - 2000	0 - 79	200	8.0	0.05		0.22	0234 226**	2042.00
<b>Vernier + scale satin chrome finished</b>										
▪		0 - 200	0 - 8	80	3.0	0.05	1/128	0.05	0234 501	129.00
▪		0 - 250	0 - 10	80	3.0	0.05	1/128	0.05	0234 502	149.00
▪		0 - 300	0 - 12	90	3.5	0.05	1/128	0.05	0234 503	164.00
▪		0 - 400	0 - 16	125	5.0	0.05		0.06	0234 505*	379.00
▪		0 - 500	0 - 20	150	6.0	0.05		0.07	0234 508*	489.00
▪		0 - 600	0 - 24	150	6.0	0.05		0.08	0234 511*	554.00
▪		0 - 800	0 - 31	150	6.0	0.05		0.1	0234 514*	628.00
▪		0 - 1000	0 - 39	150	6.0	0.05		0.12	0234 518*	754.00
	▪	0 - 1250	0 - 49	200	8.0	0.05		0.16	0234 522**	1232.00
	▪	0 - 1500	0 - 59	200	8.0	0.05		0.18	0234 524**	1585.00
	▪	0 - 2000	0 - 79	200	8.0	0.05		0.22	0234 526**	2321.00



## 0235 Workshop calipers



**DIN  
862**

**1**

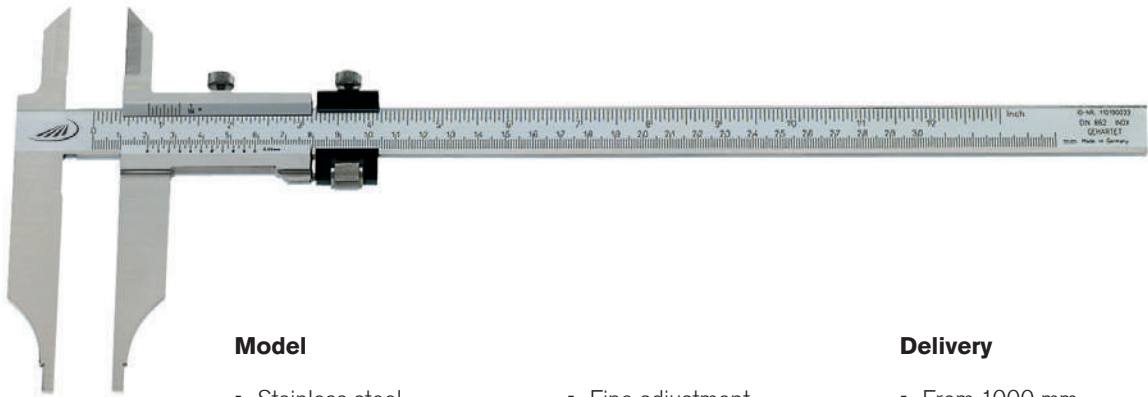

### Model

- Stainless steel
- Vernier and / or reading parts have a satin chrome finish
- DIN 862
- Locking screw
- Knife points

### Delivery

- From 1000 mm measuring range individually packed

- Fine adjustment
- Stepped jaws for inside measurement: 10 mm, 20 mm\* and 30 mm\*\*
- Low-set master scale
- High-precision laser graduation on vernier and scale

✕	📏	Measuring range		Jaw length		Reading		Error limit mm	Order no.	List price EUR
		mm	inch	mm	inch	mm	inch			
<b>Vernier satin chrome finished</b>										
▪		0 - 200	0 - 8	80	3.0	0.05	1/128	0.05	0235 201	138.00
▪		0 - 250	0 - 10	80	3.0	0.05	1/128	0.05	0235 202	159.00
▪		0 - 300	0 - 12	90	3.5	0.05	1/128	0.05	0235 203	168.00
▪		0 - 400	0 - 16	125	5.0	0.05		0.06	0235 205*	387.00
▪		0 - 500	0 - 20	150	6.0	0.05		0.07	0235 208*	471.00
▪		0 - 600	0 - 24	150	6.0	0.05		0.08	0235 211*	540.00
▪		0 - 800	0 - 31	150	6.0	0.05		0.1	0235 214*	619.00
▪		0 - 1000	0 - 39	150	6.0	0.05		0.12	0235 218*	721.00
	▪	0 - 1250	0 - 49	200	8.0	0.05		0.16	0235 222**	1184.00
	▪	0 - 1500	0 - 59	200	8.0	0.05		0.18	0235 224**	1495.00
	▪	0 - 2000	0 - 79	200	8.0	0.05		0.22	0235 226**	2208.00
<b>Vernier + scale satin chrome finished</b>										
▪		0 - 200	0 - 8	80	3.0	0.05	1/128	0.05	0235 501	147.00
▪		0 - 250	0 - 10	80	3.0	0.05	1/128	0.05	0235 502	176.00
▪		0 - 300	0 - 12	90	3.5	0.05	1/128	0.05	0235 503	189.00
▪		0 - 400	0 - 16	125	5.0	0.05		0.06	0235 505*	429.00
▪		0 - 500	0 - 20	150	6.0	0.05		0.07	0235 508*	528.00
▪		0 - 600	0 - 24	150	6.0	0.05		0.08	0235 511*	601.00
▪		0 - 800	0 - 31	150	6.0	0.05		0.1	0235 514*	692.00
▪		0 - 1000	0 - 39	150	6.0	0.05		0.12	0235 518*	817.00
	▪	0 - 1250	0 - 49	200	8.0	0.05		0.16	0235 522**	1321.00
	▪	0 - 1500	0 - 59	200	8.0	0.05		0.18	0235 524**	1681.00
	▪	0 - 2000	0 - 79	200	8.0	0.05		0.22	0235 526**	2476.00





## 0236 Workshop calipers



DIN  
862

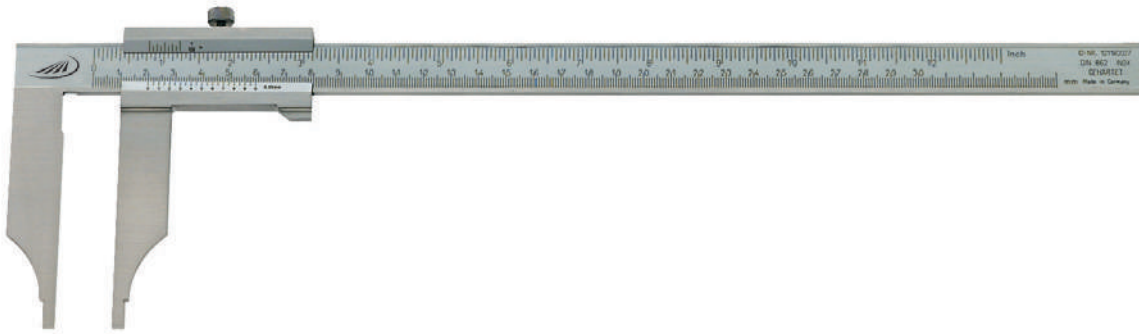

### Model

- Stainless steel
- Vernier and / or reading parts have a satin chrome finish
- Factory standard
- Locking screw
- Low-set master scale
- Stepped jaws for inside measurement: 10 mm, 20 mm\*, 30 mm\*\* and 50 mm (0236 230)
- High-precision laser graduation on vernier and scale
- 3000 mm = Factory standard

### Delivery

- From 1000 mm measuring range individually packed

⊞	⊞	Measuring range		Jaw length		Reading		Error limit	Order no.	List price
		mm	inch	mm	inch	mm	inch			
<b>Vernier satin chrome finished</b>										
▪		0 - 200	0 - 8	80	3.0	0.05	1/128	0.05	0236 201	94.00
▪		0 - 250	0 - 10	80	3.0	0.05	1/128	0.05	0236 202	115.00
▪		0 - 300	0 - 12	90	3.5	0.05	1/128	0.05	0236 203	129.00
▪		0 - 400	0 - 16	125	5.0	0.05		0.06	0236 205*	265.00
▪		0 - 500	0 - 20	150	6.0	0.05		0.07	0236 208*	349.00
▪		0 - 600	0 - 24	150	6.0	0.05		0.08	0236 211*	418.00
▪		0 - 800	0 - 31	150	6.0	0.05		0.1	0236 214*	446.00
▪		0 - 1000	0 - 39	150	6.0	0.05		0.12	0236 218*	557.00
	▪	0 - 1250	0 - 49	200	8.0	0.05		0.14	0236 222**	863.00
	▪	0 - 1500	0 - 59	200	8.0	0.05		0.18	0236 224**	1176.00
	▪	0 - 2000	0 - 79	200	8.0	0.05		0.22	0236 226**	1621.00
	▪	0 - 3000	0 - 118	200	8.0	0.05		0.22	0236 230	2682.00
<b>Vernier + scale satin chrome finished</b>										
▪		0 - 200	0 - 8	80	3.0	0.05	1/128	0.05	0236 501	107.00
▪		0 - 250	0 - 10	80	3.0	0.05	1/128	0.05	0236 502	135.00
▪		0 - 300	0 - 12	90	3.5	0.05	1/128	0.05	0236 503	146.00
▪		0 - 400	0 - 16	125	5.0	0.05		0.06	0236 505*	309.00
▪		0 - 500	0 - 20	150	6.0	0.05		0.07	0236 508*	407.00
▪		0 - 600	0 - 24	150	6.0	0.05		0.08	0236 511*	487.00
▪		0 - 800	0 - 31	150	6.0	0.05		0.1	0236 514*	504.00
▪		0 - 1000	0 - 39	150	6.0	0.05		0.12	0236 518**	629.00
	▪	0 - 1250	0 - 49	200	8.0	0.05		0.16	0236 522**	1034.00
	▪	0 - 1500	0 - 59	200	8.0	0.05		0.18	0236 524**	1387.00
	▪	0 - 2000	0 - 79	200	8.0	0.05		0.22	0236 526	2090.00



## 0237 Workshop calipers



**DIN  
862**

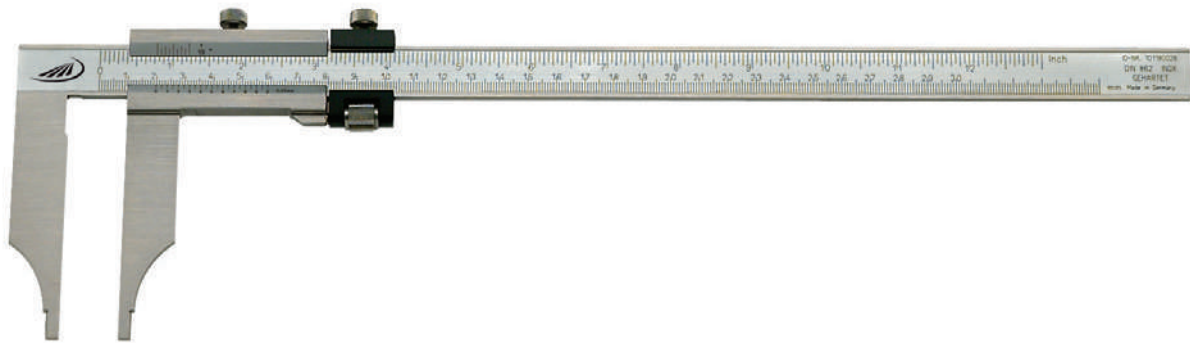

**1**

### Model

- Stainless steel
- Vernier and / or reading parts have a satin chrome finish
- Factory standard
- Locking screw
- Fine adjustment
- Low-set master scale

### Delivery

- Stepped jaws for inside measurement: 10 mm, 20 mm\*, 30 mm\*\* and 50 mm (0237 230)
- High-precision laser graduation on vernier and scale
- 3000 mm = Factory standard
- From 1000 mm measuring range individually packed

Icon	Measuring range		Jaw length		Reading		Error limit	Order no.	List price	
	mm	inch	mm	inch	mm	inch				mm
<b>Vernier satin chrome finished</b>										
▪	0 - 200	0 - 8	80	3.0	0.05	1/128	0.05	0237 201	121.00	
▪	0 - 250	0 - 10	80	3.0	0.05	1/128	0.05	0237 202	143.00	
▪	0 - 300	0 - 12	90	3.5	0.05	1/128	0.05	0237 203	156.00	
▪	0 - 400	0 - 16	125	5.0	0.05		0.06	0237 205*	317.00	
▪	0 - 500	0 - 20	150	6.0	0.05		0.07	0237 208*	403.00	
▪	0 - 600	0 - 24	150	6.0	0.05		0.08	0237 211*	471.00	
▪	0 - 800	0 - 31	150	6.0	0.05		0.1	0237 214*	507.00	
▪	0 - 1000	0 - 39	150	6.0	0.05		0.12	0237 218*	619.00	
▪	0 - 1250	0 - 49	200	8.0	0.05		0.16	0237 222**	961.00	
▪	0 - 1500	0 - 59	200	8.0	0.05		0.18	0237 224**	1275.00	
▪	0 - 2000	0 - 79	200	8.0	0.05		0.22	0237 226**	1782.00	
▪	0 - 3000	0 - 118	200	8.0	0.05		0.22	0237 230	2914.00	
<b>Vernier + scale satin chrome finished</b>										
▪	0 - 200	0 - 8	80	3.0	0.05	1/128	0.05	0237 501	132.00	
▪	0 - 250	0 - 10	80	3.0	0.05	1/128	0.05	0237 502	162.00	
▪	0 - 300	0 - 12	90	3.5	0.05	1/128	0.05	0237 503	174.00	
▪	0 - 400	0 - 16	125	5.0	0.05		0.06	0237 505*	362.00	
▪	0 - 500	0 - 20	150	6.0	0.05		0.07	0237 508*	457.00	
▪	0 - 600	0 - 24	150	6.0	0.05		0.08	0237 511*	536.00	
▪	0 - 800	0 - 31	150	6.0	0.05		0.1	0237 514*	567.00	
▪	0 - 1000	0 - 39	150	6.0	0.05		0.12	0237 518*	693.00	
▪	0 - 1250	0 - 49	200	8.0	0.05		0.16	0237 522**	1128.00	
▪	0 - 1500	0 - 59	200	8.0	0.05		0.18	0237 524**	1484.00	
▪	0 - 2000	0 - 79	200	8.0	0.05		0.22	0237 526**	2249.00	



## 0236 Workshop calipers with long measuring jaws

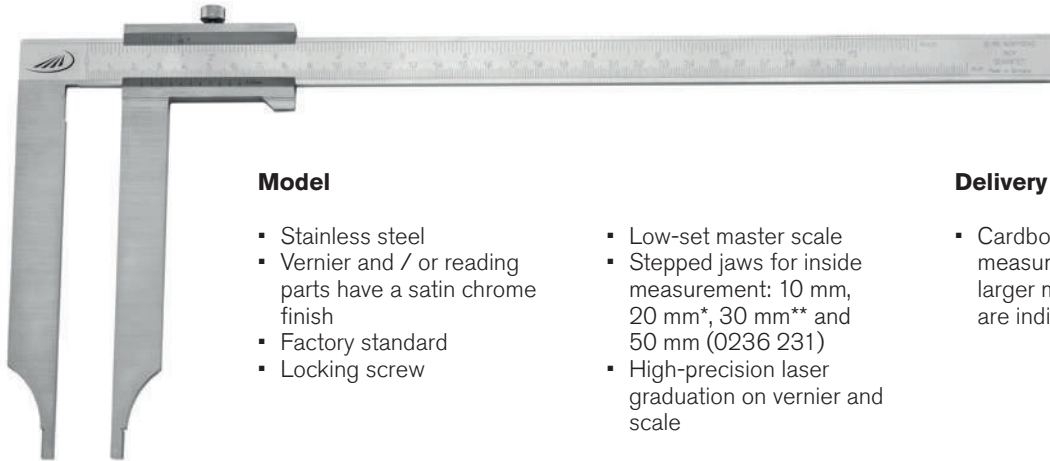

### Model

- Stainless steel
- Vernier and / or reading parts have a satin chrome finish
- Factory standard
- Locking screw

### Delivery

- Cardboard box up to measuring range 1000 mm, larger measuring ranges are individually packed

- Low-set master scale
- Stepped jaws for inside measurement: 10 mm, 20 mm\*, 30 mm\*\* and 50 mm (0236 231)
- High-precision laser graduation on vernier and scale

⊗	☒	Measuring range		Jaw length		Reading		Error limit	Order no.	List price
		mm	inch	mm	inch	mm	inch			
<b>Vernier satin chrome finished</b>										
		0 - 300	12	150	6.0	0.05	1/128	0.1	0236 204	240.00
		0 - 400	16	150	5.0	0.05		0.1	0236 206*	341.00
		0 - 400	16	200	8.0	0.05		0.12	0236 207*	416.00
		0 - 500	20	200	8.0	0.05		0.14	0236 209*	463.00
		0 - 500	20	250	10.0	0.05		0.14	0236 210*	557.00
		0 - 600	24	200	8.0	0.05		0.16	0236 212*	580.00
		0 - 600	24	300	12.0	0.05		0.16	0236 213*	714.00
		0 - 800	31	200	8.0	0.05		0.2	0236 215*	671.00
		0 - 800	31	300	12.0	0.05		0.2	0236 216*	859.00
		0 - 800	31	400	16.0	0.05		0.2	0236 217*	997.00
		0 - 1000	39	200	8.0	0.05		0.24	0236 219*	824.00
		0 - 1000	39	300	12.0	0.05		0.24	0236 220*	920.00
		0 - 1000	39	500	20.0	0.05		0.24	0236 221*	1387.00
	▪	0 - 1500	59	300	12.0	0.05		0.36	0236 225**	1422.00
	▪	0 - 2000	79	300	12.0	0.05		0.44	0236 227**	1979.00
	▪	0 - 3000	118	300	12.0	0.05		0.64	0236 231	3271.00
<b>Vernier + scale satin chrome finished</b>										
		0 - 300	12	150	6.0	0.05	1/128	0.1	0236 504	258.00
		0 - 400	16	150	6.0	0.05		0.12	0236 506*	397.00
		0 - 400	16	200	8.0	0.05		0.12	0236 507*	482.00
		0 - 500	20	200	8.0	0.05		0.14	0236 509*	536.00
		0 - 500	20	250	10.0	0.05		0.14	0236 510*	640.00
		0 - 600	24	200	8.0	0.05		0.16	0236 512*	605.00
		0 - 600	24	300	12.0	0.05		0.16	0236 513*	788.00
		0 - 800	31	200	8.0	0.05		0.2	0236 515*	779.00
		0 - 800	31	300	12.0	0.05		0.2	0236 516*	994.00
		0 - 800	31	400	16.0	0.05		0.2	0236 517*	1166.00
		0 - 1000	39	200	8.0	0.05		0.24	0236 519*	956.00
		0 - 1000	39	300	12.0	0.05		0.24	0236 520*	1206.00
		0 - 1000	39	500	20.0	0.05		0.24	0236 521*	1647.00
	▪	0 - 1500	59	300	12.0	0.05		0.36	0236 525**	1692.00
	▪	0 - 2000	79	300	12.0	0.05		0.44	0236 527**	2506.00



## 0237 Workshop calipers with long measuring jaws

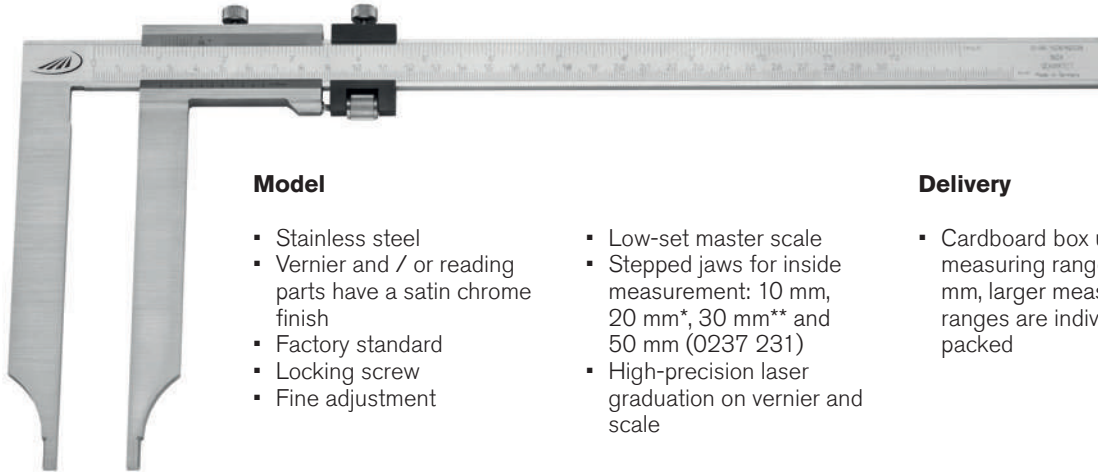

### Model

- Stainless steel
- Vernier and / or reading parts have a satin chrome finish
- Factory standard
- Locking screw
- Fine adjustment

### Delivery

- Cardboard box up to measuring range 1000 mm, larger measuring ranges are individually packed

✕	📏	Measuring range		Jaw length		Reading		Error limit mm	Order no.	List price EUR
		mm	inch	mm	inch	mm	inch			
<b>Vernier satin chrome finished</b>										
		0 - 300	0 - 12	150	6.0	0.05	1/128	0.1	0237 204	266.00
		0 - 400	0 - 16	150	6.0	0.05		0.12	0237 206*	393.00
		0 - 400	0 - 16	200	8.0	0.05		0.12	0237 207*	469.00
		0 - 500	0 - 20	200	8.0	0.05		0.14	0237 209*	517.00
		0 - 500	0 - 20	250	10.0	0.05		0.14	0237 210*	610.00
		0 - 600	0 - 24	200	8.0	0.05		0.16	0237 212*	630.00
		0 - 600	0 - 24	300	8.0	0.05		0.16	0237 213*	767.00
		0 - 800	0 - 31	200	8.0	0.05		0.2	0237 215*	737.00
		0 - 800	0 - 31	300	12.0	0.05		0.2	0237 216*	922.00
		0 - 800	0 - 31	400	16.0	0.05		0.2	0237 217*	1062.00
		0 - 1000	0 - 39	200	8.0	0.05		0.24	0237 219*	890.00
		0 - 1000	0 - 39	300	12.0	0.05		0.24	0237 220*	985.00
		0 - 1000	0 - 39	500	20.0	0.05		0.24	0237 221*	1450.00
	▪	0 - 1500	0 - 59	300	12.0	0.05		0.36	0237 225**	1521.00
	▪	0 - 2000	0 - 79	300	12.0	0.05		0.44	0237 227**	2138.00
	▪	0 - 3000	0 - 118	300	12.0	0.05		0.64	0237 231	3502.00
<b>Vernier + scale satin chrome finished</b>										
		0 - 300	0 - 12	150	6.0	0.05	1/128	0.1	0237 504	283.00
		0 - 400	0 - 16	150	6.0	0.05		0.12	0237 506*	448.00
		0 - 400	0 - 16	200	8.0	0.05		0.12	0237 507*	534.00
		0 - 500	0 - 20	200	8.0	0.05		0.14	0237 509*	586.00
		0 - 500	0 - 20	250	10.0	0.05		0.14	0237 510*	691.00
		0 - 600	0 - 24	200	8.0	0.05		0.16	0237 512*	704.00
		0 - 600	0 - 24	300	12.0	0.05		0.16	0237 513*	841.00
		0 - 800	0 - 31	200	8.0	0.05		0.2	0237 515*	843.00
		0 - 800	0 - 31	300	12.0	0.05		0.2	0237 516*	1055.00
		0 - 800	0 - 31	400	16.0	0.05		0.2	0237 517*	1231.00
		0 - 1000	0 - 39	200	8.0	0.05		0.24	0237 519*	1016.00
		0 - 1000	0 - 39	300	12.0	0.05		0.24	0237 520*	1269.00
		0 - 1000	0 - 39	500	20.0	0.05		0.24	0237 521*	1713.00
	▪	0 - 1500	0 - 59	300	12.0	0.05		0.36	0237 525**	1792.00
	▪	0 - 2000	0 - 79	300	12.0	0.05		0.44	0237 527**	2663.00



## 0238 Lightweight workshop calipers

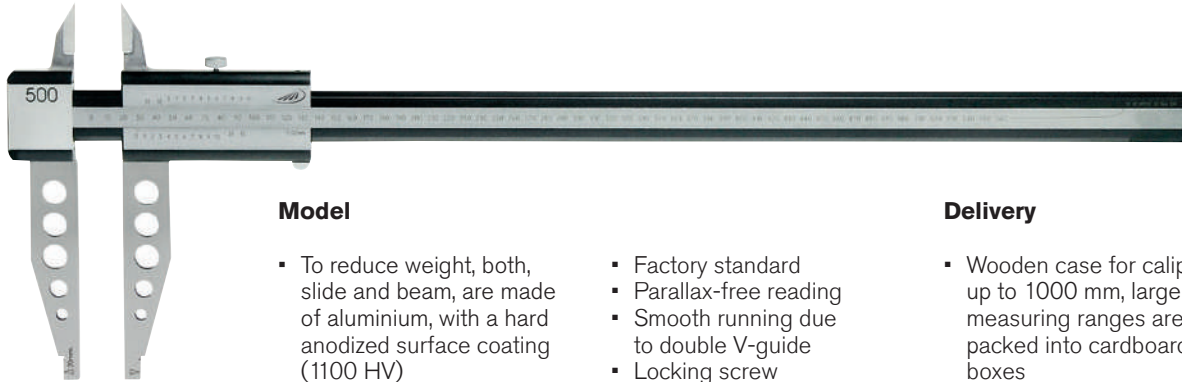

### Model

- To reduce weight, both, slide and beam, are made of aluminium, with a hard anodized surface coating (1100 HV)
- Measuring faces are made of hardened stainless steel
- Factory standard
- Parallax-free reading
- Smooth running due to double V-guide
- Locking screw
- Knife points
- Stepped jaws for inside measurement 20 mm

### Delivery

- Wooden case for calipers up to 1000 mm, larger measuring ranges are packed into cardboard boxes

✕	📏	Measuring range	Jaw length	Reading	Error limit	Order no.	List price
		mm	mm	mm	mm		EUR
		0 - 300	90	0.02	0.05	0238 503	379.00
		0 - 500	150	0.02	0.07	0238 508	542.00
		0 - 800	150	0.02	0.1	0238 514	724.00
		0 - 1000	150	0.02	0.12	0238 518	848.00
	▪	0 - 1500	200	0.05	0.17	0238 524	2199.00
	▪	0 - 2000	200	0.05	0.22	0238 526	2560.00



## 0265 Caliper with cross points

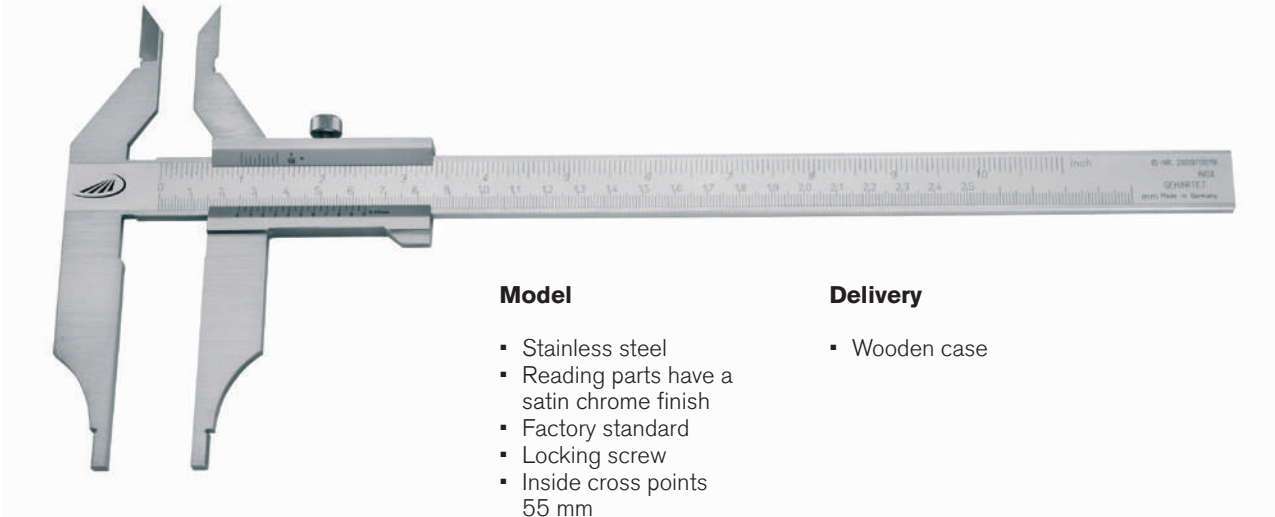

1

### Model

- Stainless steel
- Reading parts have a satin chrome finish
- Factory standard
- Locking screw
- Inside cross points 55 mm

### Delivery

- Wooden case

Icon	Measuring range	Jaw length		Reading	Error limit	Order no.	List price
	mm	mm	inch	mm	mm		EUR
	0 - 250	80	3.1	0.02	0.03	0265 52005	270.00

## 0266 Caliper with gripper points

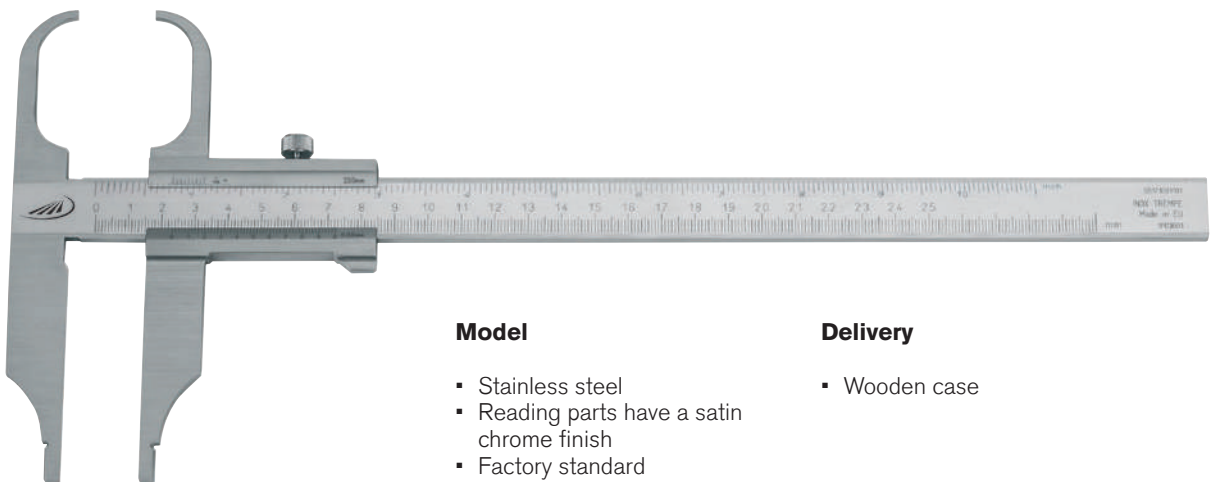

### Model

- Stainless steel
- Reading parts have a satin chrome finish
- Factory standard
- Locking screw
- Gripper points 55 mm

### Delivery

- Wooden case

Icon	Measuring range	Jaw length		Reading	Error limit	Order no.	List price
	mm	mm	inch	mm	mm		EUR
	0 - 250	75	3.0	0.02	0.03	0266 52005	362.00



## 1330 / 1331 DIGI-MET® Workshop calipers



1330 522

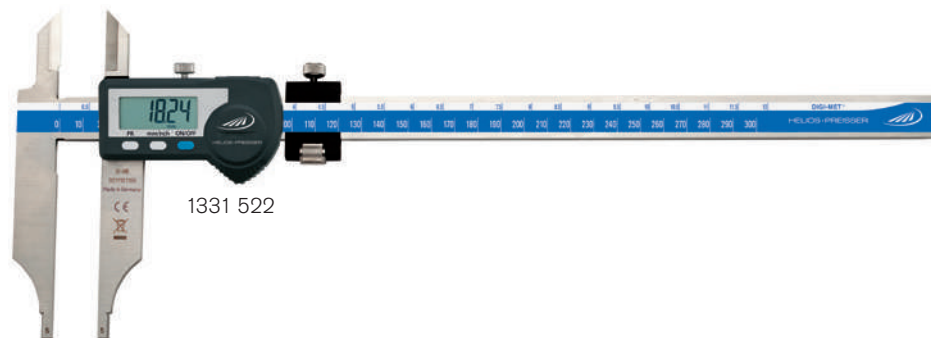

1331 522

### Model

- Stainless steel
- Inductive measuring system, resistant to damp and sweat
- DIN 862
- Knife points
- LCD display:
  - 10 mm with measuring range 300 mm;
  - 12.5 mm from measuring range 500 mm
- Locking screw

### Functions

- ON / OFF
- **Quick-Start**
- **Quick-Lock** (key lock)
- Set to zero at any point
- mm / inch switching
- PRESET-Function (setting a numerical value)
- Variable data output RS 232 + Digimatic + USB

### Delivery

- Wooden case

☒	🇩🇪	Measuring range		Jaw length		Reading		Stepped jaws mm	Error limit mm	Order no.	List price EUR
		mm	inch	mm	inch	mm	inch				
<b>With knife points, without fine adjustment</b>											
▪		0 - 300	0 - 12	90	3.5	0.01	.0005	10	0.03	1330 522	398.00
▪		0 - 500	0 - 20	125	5.0	0.01	.0005	20	0.03	1330 528	607.00
▪		0 - 800	0 - 31	150	6.0	0.01	.0005	20	0.04	1330 532	992.00
▪		0 - 1000	0 - 39	150	6.0	0.01	.0005	20	0.04	1330 534	1200.00
<b>With knife points, with fine adjustment</b>											
▪		0 - 300	0 - 12	90	3.5	0.01	.0005	10	0.03	1331 522	462.00
▪		0 - 500	0 - 20	125	5.0	0.01	.0005	20	0.03	1331 528	681.00
▪		0 - 800	0 - 31	150	6.0	0.01	.0005	20	0.04	1331 532	1049.00
▪		0 - 1000	0 - 39	150	6.0	0.01	.0005	20	0.04	1331 534	1206.00

### Accessories



1998720

1997501

1998501

	Order no.	List price EUR
Battery, 3V-Lithium, CR 2032	0220 704	3.90
Data cable DATA VARIABLE to USB	1998 720	72.00
Data cable DATA VARIABLE to RS232	1997 501	50.00
Data cable DATA VARIABLE to Digimatic	1998 501	64.00



## 1334 / 1335 DIGI-MET® Workshop calipers



1

### Model

- Stainless steel
- Inductive measuring system, resistant to damp and sweat
- DIN 862
- LCD display:
  - 10 mm with measuring range 300 mm;
  - 12.5 mm from measuring range 500 mm
- Locking screw

### Functions

- ON / OFF
- **Quick-Start**
- **Quick-Lock** (key lock)
- Set to zero at any point
- mm / inch switching
- PRESET-Function (setting a numerical value)
- Variable data output RS 232 + Digimatic + USB

### Delivery

- Wooden case

Icon	Measuring range		Jaw length		Reading		Stepped jaws	Error limit	Order no.	List price
	mm	inch	mm	inch	mm	inch				
<b>Without fine adjustment</b>										
▪	0 - 300	0 - 12	90	3.5	0.01	.0005	10	0.03	1334 522	369.00
▪	0 - 500	0 - 20	125	5.0	0.01	.0005	20	0.03	1334 528	518.00
▪	0 - 800	0 - 31	150	6.0	0.01	.0005	20	0.04	1334 532	905.00
▪	0 - 1000	0 - 39	150	6.0	0.01	.0005	20	0.04	1334 534	1071.00
<b>With fine adjustment</b>										
▪	0 - 300	0 - 12	90	3.5	0.01	.0005	10	0.03	1335 522	422.00
▪	0 - 500	0 - 20	125	5.0	0.01	.0005	20	0.03	1335 528	596.00
▪	0 - 800	0 - 31	150	6.0	0.01	.0005	20	0.04	1335 532	973.00
▪	0 - 1000	0 - 39	150	6.0	0.01	.0005	20	0.04	1335 534	1118.00



### Accessories

- Battery, 3V-Lithium, CR 2032
- Data cable DATA VARIABLE to USB
- Data cable DATA VARIABLE to RS232
- Data cable DATA VARIABLE to Digimatic

### Order no.

### List price

0220 704	3.90
1998 720	72.00
1997 501	50.00
1998 501	64.00





## 1340 / 1341 DIGI-MET® Workshop calipers IP65



### Model

- Stainless steel
- Inductive measuring system, protection class IP65
- DIN 862
- Knife points
- LCD display:
  - 10 mm with measuring range 300 mm;
  - 12.5 mm from measuring range 500 mm
- Locking screw

### Functions

- ON / OFF
- **Quick-Start**
- **Quick-Lock** (key lock)
- Set to zero at any point
- mm / inch switching
- PRESET-Function (setting a numerical value)
- Variable data output RS 232 + Digimatic + USB

### Delivery

- Wooden case

Marked	Measuring range	Jaw length		Reading		Stepped jaws	Error limit	Order no.	List price	
		mm	inch	mm	inch					mm
<b>With knife points, without fine adjustment</b>										
▪	0 - 300	0 - 12	90	3.5	0.01	.0005	10	0.03	1340 522	431.00
▪	0 - 500	0 - 20	125	5.0	0.01	.0005	20	0.03	1340 528	822.00
▪	0 - 800	0 - 31	150	6.0	0.01	.0005	20	0.04	1340 532	1110.00
▪	0 - 1000	0 - 39	150	6.0	0.01	.0005	20	0.04	1340 534	1365.00
<b>With knife points, with fine adjustment</b>										
▪	0 - 300	0 - 12	90	3.5	0.01	.0005	10	0.03	1341 522	488.00
▪	0 - 500	0 - 20	125	5.0	0.01	.0005	20	0.03	1341 528	878.00
▪	0 - 800	0 - 31	150	6.0	0.01	.0005	20	0.04	1341 532	1165.00
▪	0 - 1000	0 - 39	150	6.0	0.01	.0005	20	0.04	1341 534	1420.00



1998720

1997501

1998501

### Accessories

- Battery, 3V-Lithium, CR 2032
- Data cable DATA VARIABLE to USB
- Data cable DATA VARIABLE to RS232
- Data cable DATA VARIABLE to digimatic

### Order no.

### List price

EUR

0220 704

3.90

1998 720

72.00

1997 501

50.00

1998 501

64.00



HELIOS • PREISSER

1342 / 1343 DIGI-MET® Workshop calipers IP65



1



**Model**

- Stainless steel
- Inductive measuring system, protection class IP65
- DIN 862
- LCD display:
  - 10 mm with measuring range 300 mm;
  - 12.5 mm from measuring range 500 mm
- Locking screw

**Functions**

- ON / OFF
- **Quick-Start**
- **Quick-Lock** (key lock)
- Set to zero at any point
- mm / inch switching
- PRESET-Function (setting a numerical value)
- Variable data output RS 232 + Digimatic + USB

**Delivery**

- Wooden case

Icon	Measuring range		Jaw length		Reading		Stepped jaws	Error limit	Order no.	List price
	mm	inch	mm	inch	mm	inch				
<b>Without fine adjustment</b>										
▪	0 - 300	0 - 12	90	3.5	0.01	.0005	10	0.03	1342 522	396.00
▪	0 - 500	0 - 20	125	5.0	0.01	.0005	20	0.03	1342 528	731.00
▪	0 - 800	0 - 31	150	6.0	0.01	.0005	20	0.04	1342 532	1012.00
▪	0 - 1000	0 - 39	150	6.0	0.01	.0005	20	0.04	1342 534	1259.00
<b>With fine adjustment</b>										
▪	0 - 300	0 - 12	90	3.5	0.01	.0005	10	0.03	1343 522	452.00
▪	0 - 500	0 - 20	125	5.0	0.01	.0005	20	0.03	1343 528	788.00
▪	0 - 800	0 - 31	150	6.0	0.01	.0005	20	0.04	1343 532	1068.00
▪	0 - 1000	0 - 39	150	6.0	0.01	.0005	20	0.04	1343 534	1314.00



**Accessories**

	Order no.	List price
Battery, 3V-Lithium, CR 2032	0220 704	3.90
Data cable DATA VARIABLE to USB	1998 720	72.00
Data cable DATA VARIABLE to RS232	1997 501	50.00
Data cable DATA VARIABLE to digimatic	1998 501	64.00



## 0222 / 0223 DIGI-MET® Workshop calipers long version

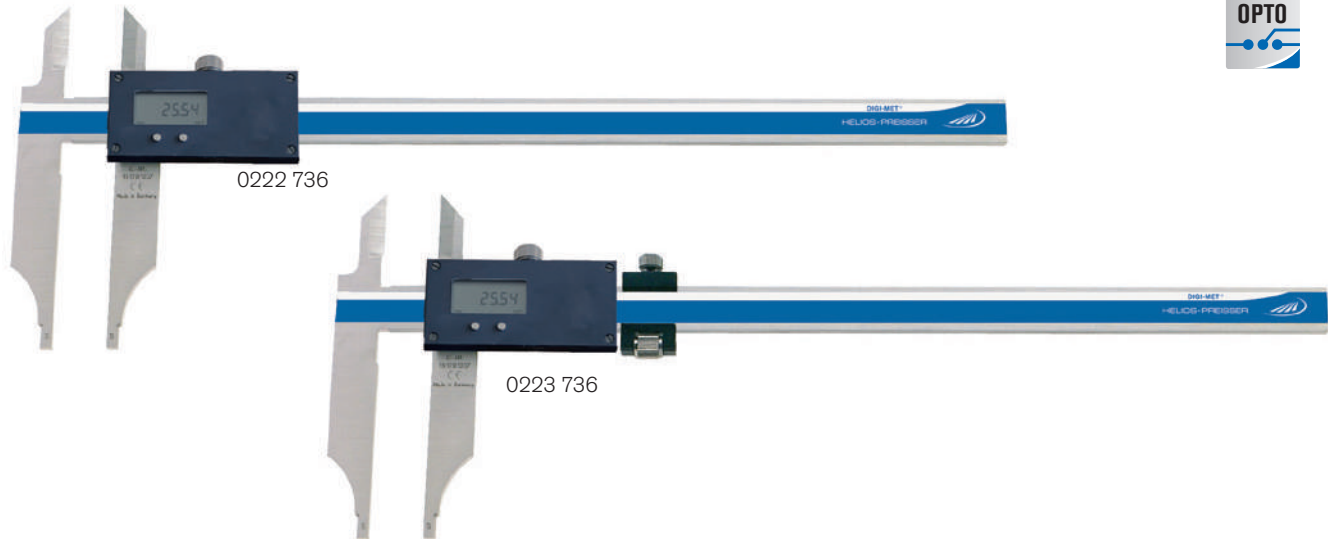

### Model

- Stainless steel
- LCD display 10 mm
- Locking screw
- Knife points
- Factory standard

### Functions

- ON / OFF
- Set to zero at any point
- mm / inch switching
- Hold
- Data output Opto RS 232
- PRESET-Function (setting a numerical value)

### Delivery

- Wooden case

▶◀	🏠	Measuring range		Jaw length		Reading		Error limit	Order no.	List price
		mm	inch	mm	inch	mm	inch	mm		EUR
<b>With knife points, without fine adjustment</b>										
	▪	0 - 1500	0 - 59	200	8.0	0.01	.0005	0.1	0222 734	2677.00
	▪	0 - 2000	0 - 79	200	8.0	0.01	.0005	0.12	0222 736	3212.00
<b>With knife points, with fine adjustment</b>										
	▪	0 - 1500	0 - 59	200	8.0	0.01	.0005	0.1	0223 734	2856.00
	▪	0 - 2000	0 - 79	200	8.0	0.01	.0005	0.12	0223 736	3309.00



### Accessories

	Order no.	List price
Battery, 3V-Lithium, CR 2032	0220 704	3.90
Data cable opto to RS232	0996 701	77.00
Data cable opto to USB	0996 705	147.00
USB-keyboard interface cable	0997 770	251.00



## 0224 / 0225 DIGI-MET® Workshop calipers long version



1



0224 736



0225 736

### Model

- Stainless steel
- LCD display 10 mm
- Locking screw
- Without knife points
- Factory standard

### Functions

- ON / OFF
- Set to zero at any point
- mm / inch switching
- Hold
- Data output Opto RS 232
- PRESET-Function (setting a numerical value)

### Delivery

- Wooden case

Icon	Measuring range		Jaw length		Reading		Error limit	Order no.	List price	
	mm	inch	mm	inch	mm	inch				mm
<b>Without fine adjustment</b>										
▪	0 - 1500	0 - 59	200	8.0	0.01	.0005	0.1	0224 734	2421.00	
▪	0 - 2000	0 - 79	200	8.0	0.01	.0005	0.12	0224 736	2934.00	
<b>With fine adjustment</b>										
▪	0 - 1500	0 - 59	200	8.0	0.01	.0005	0.1	0225 734	2552.00	
▪	0 - 2000	0 - 79	200	8.0	0.01	.0005	0.12	0225 736	3029.00	



0996705

0996701

0997770

### Accessories

	Order no.	List price
		EUR
Battery, 3V-Lithium, CR 2032	0220 704	3.90
Data cable opto to RS232	0996 701	77.00
Data cable opto to USB	0996 705	147.00
USB-keyboard interface cable	0997 770	251.00



## 1351 DIGI-MET® Workshop calipers with cross points



1351 522

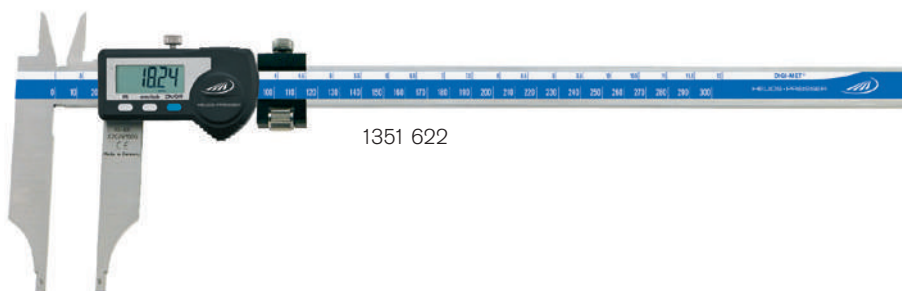

1351 622

### Model

- Stainless steel
- DIN 862
- Protection class IP65
- LCD display
- 10 mm with measuring range 300 mm;
- 12.5 mm from measuring range 500 mm
- Locking screw
- Inside cross points
- Three way measurement

### Functions

- ON / OFF
- **Quick-Start**
- **Quick-Lock** (key lock)
- Set to zero at any point
- mm / inch switching
- PRESET-Function (setting a numerical value)
- Variable data output RS 232 + Digimatic + USB

### Delivery

- Wooden case

Measuring range	Jaw length		Reading		Error limit	Order no.	List price	
	mm	inch	mm	inch				mm
<b>Without fine adjustment</b>								
0 - 300	0 - 12	90	3.5	0.01	.0005	0.03	1351 522	554.00
0 - 500	0 - 20	125	5.0	0.01	.0005	0.03	1351 528	717.00
<b>With fine adjustment</b>								
0 - 300	0 - 12	90	3.5	0.01	.0005	0.03	1351 622	591.00
0 - 500	0 - 20	125	5.0	0.01	.0005	0.03	1351 628	784.00



1998720

1997501

1998501

### Accessories

	Order no.	List price
Battery, 3V-Lithium, CR 2032	0220 704	3.90
Data cable DATA VARIABLE to USB	1998 720	72.00
Data cable DATA VARIABLE to digimatic	1998 501	64.00
Data cable DATA VARIABLE to RS232	1997 501	50.00



## 1338 DIGI-MET® Workshop caliper PRISMA



1

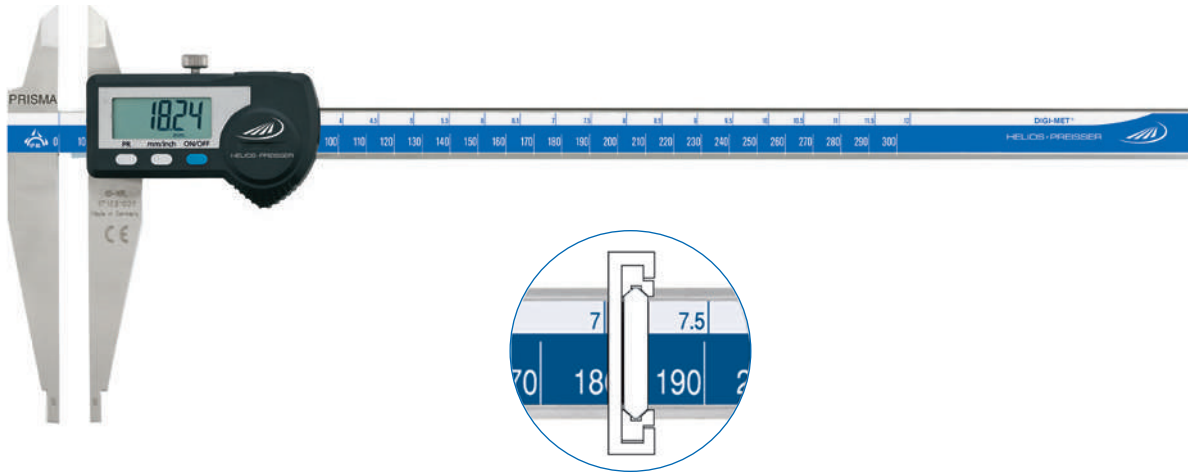

### Model

- Double prisma guide with excellent sliding characteristics
- Stainless steel
- Accuracy in accordance to DIN 862
- Protection class IP65
- LCD display 10 mm
- Locking screw
- Knife points
- Stepped jaws for inside measurement 10 mm

### Functions

- ON / OFF
- **Quick-Start**
- **Quick-Lock** (key lock)
- Set to zero at any point
- mm / inch switching
- PRESET-Function (setting a numerical value)
- Variable data output RS 232 + Digimatic + USB

### Delivery

- Wooden case

Icon	Measuring range		Jaw length		Reading		Error limit	Order no.	List price
	mm	inch	mm	inch	mm	inch	mm		EUR
▪	0 - 300	0 - 12	90	3.5	0.01	.0005	0.03	1338 522	475.00



1998720    1997501    1998501

### Accessories

	Order no.	List price
Battery, 3V-Lithium, CR 2032	0220 704	3.90
Data cable DATA VARIABLE to RS232	1997 501	50.00
Data cable DATA VARIABLE to digimatic	1998 501	64.00
Data cable DATA VARIABLE to USB	1998 720	72.00



## 0228 DIGI-MET® Workshop calipers lightweight

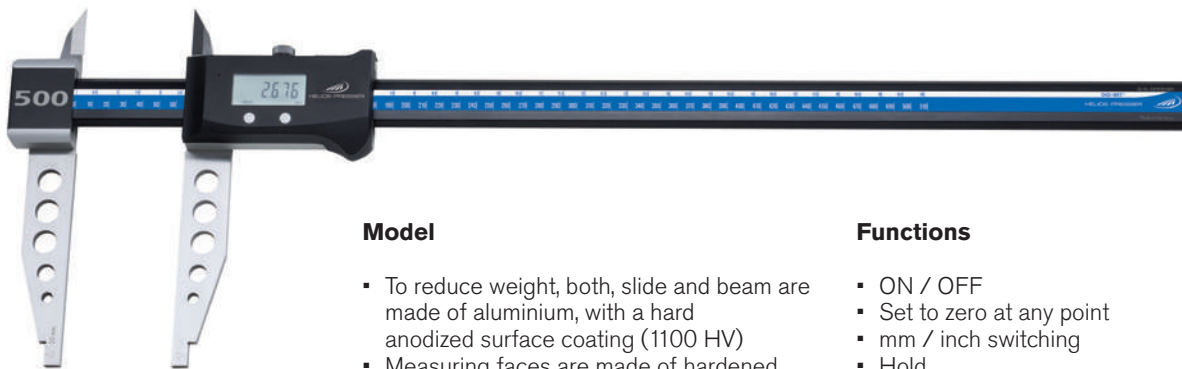

### Model

- To reduce weight, both, slide and beam are made of aluminium, with a hard anodized surface coating (1100 HV)
- Measuring faces are made of hardened stainless steel
- Factory standard
- Smooth movement due to the double V-guide
- LCD display
- Locking screw
- Knife points

### Functions

- ON / OFF
- Set to zero at any point
- mm / inch switching
- Hold
- PRESET-Function (setting a numerical value)

### Delivery

- Wooden case

✕	🏠	Measuring range		Jaw length		Reading		Error limit	Order no.	List price
		mm	inch	mm	inch	mm	inch	mm		EUR
		0 - 300	0 - 12	90	3.5	0.01	.0005	0.03	0228 701	493.00
		0 - 500	0 - 20	150	6.0	0.01	.0005	0.03	0228 702	686.00
		0 - 800	0 - 31	150	6.0	0.01	.0005	0.08	0228 703	964.00
		0 - 1000	0 - 39	150	6.0	0.01	.0005	0.08	0228 704	1137.00
	▪	0 - 1500	0 - 59	150	6.0	0.01	.0005	0.1	0228 724	2869.00
	▪	0 - 2000	0 - 79	150	6.0	0.01	.0005	0.12	0228 726	3410.00

### Accessories

Battery, 3V-Lithium, CR 2032

Order no.

0220 704

List price

EUR  
3.90

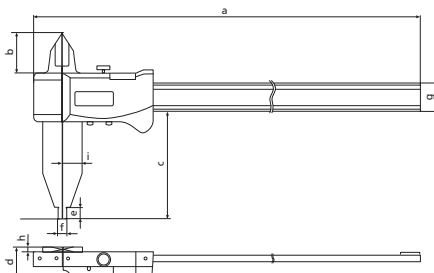

Measuring range mm	a	b	c	d	e	f	g	h	i
300	450	33	90	24.5	10	10	25.0	4.5	17.0
500	726	42	150	33.5	15	20	31.9	6.0	29.0
800	1026	42	150	33.5	15	20	31.9	6.0	29.0
1000	1226	42	150	33.5	15	20	31.9	6.0	29.0
1500	1726	42	150	33.5	15	20	31.9	6.0	29.0
2000	2226	42	150	33.5	15	20	31.9	6.0	29.0



# HELIOS · PREISSER

## 1351 DIGI-MET® Caliper with cross points

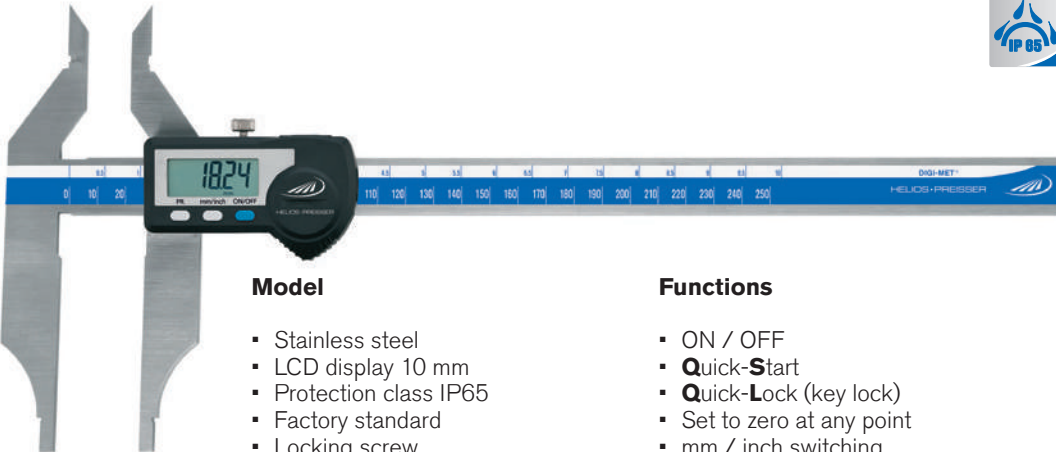

### Model

- Stainless steel
- LCD display 10 mm
- Protection class IP65
- Factory standard
- Locking screw
- Inside cross points 55 mm

### Functions

- ON / OFF
- **Quick-Start**
- **Quick-Lock** (key lock)
- Set to zero at any point
- mm / inch switching
- PRESET-Function (setting a numerical value)
- Variable data output RS 232 + Digimatic + USB

### Delivery

- Wooden case

Measuring range	Jaw length		Reading		Error limit	Order no.	List price	
	mm	inch	mm	inch				mm
0 - 250	0 - 10	80	3.2	0.01	.0005	0.03	1351 920	499.00



1998720

1997501

1998501

### Accessories

	Order no.	List price
		EUR
Battery, 3V-Lithium, CR 2032	0220 704	3.90
Data cable DATA VARIABLE to RS232	1997 501	50.00
Data cable DATA VARIABLE to digimatic	1998 501	64.00
Data cable DATA VARIABLE to USB	1998 720	72.00



## 1354 DIGI-MET® Caliper with gripper points

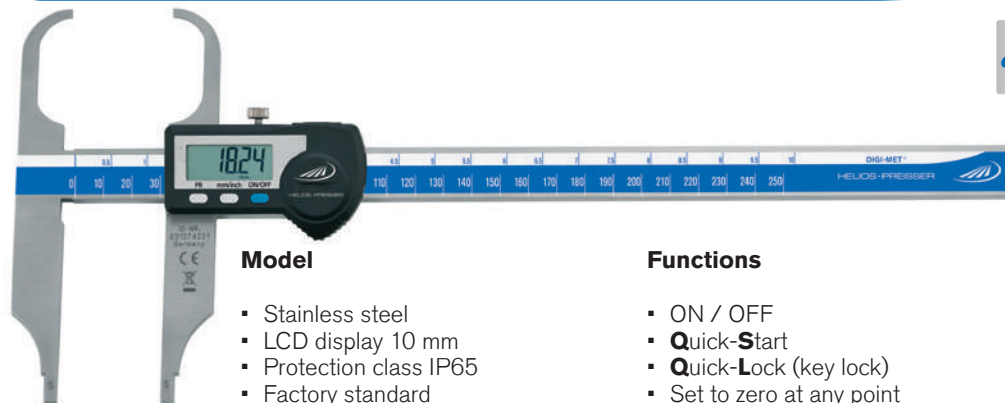

### Model

- Stainless steel
- LCD display 10 mm
- Protection class IP65
- Factory standard
- Locking screw
- Gripper points 55 mm

### Functions

- ON / OFF
- **Quick-Start**
- **Quick-Lock** (key lock)
- Set to zero at any point
- mm / inch switching
- Hold
- PRESET-Function (setting a numerical value)

- Variable data output RS 232 + Digimatic + USB

### Delivery

- Wooden case

Measuring range	Jaw length		Reading		Error limit	Order no.	List price	
	mm	inch	mm	inch				mm
0 - 250	0 - 10	75	3.0	0.01	.0005	0.03	1354 520	590.00







## 1348 DIGI-MET® Universal calipers

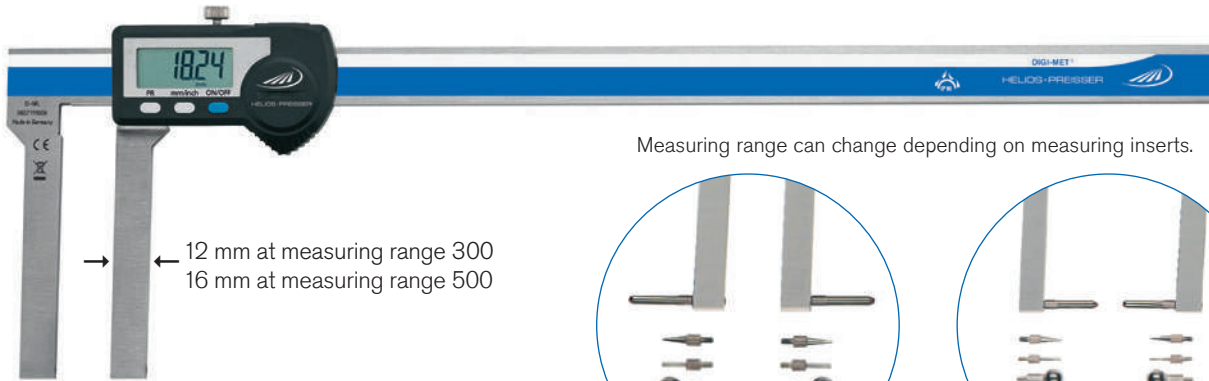

→ ← 12 mm at measuring range 300  
16 mm at measuring range 500

Measuring range can change depending on measuring inserts.

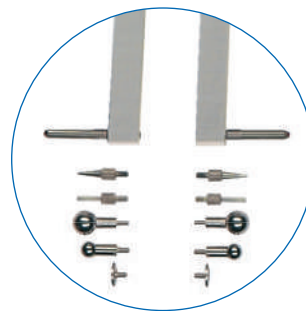

for internal measurements

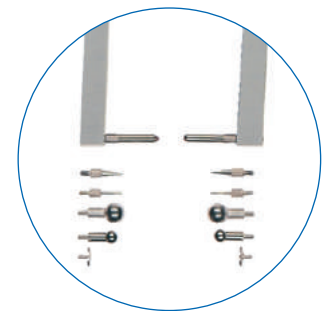

for external measurements

### Model

- Stainless steel
- Factory standard
- Protection class IP65
- LCD display 10 or 12.5 mm
- Locking screw
- For internal and external measurements
- Individually adaptable on problematic tasks through measuring inserts with thread M 2.5

### Functions

- ON / OFF
- **Quick-Start**
- **Quick-Lock** (key lock)
- Set to zero at any point
- mm / inch switching
- PRESET-Function (setting a numerical value)
- Variable data output RS 232 + Digimatic + USB

### Delivery

- Wooden box
- Without measuring inserts (correct measuring inserts with thread M 2.5 see pages 137 - 140)

Model „Pocket Talent“ with measuring range 150 mm on page 29

✕	Measuring range		Jaw length		Reading		Error limit	Order no.	List price
	mm	inch	mm	inch	mm	inch	mm		EUR
	0 - 300	0 - 12	90	3.5	0.01	.0005	0.06	1348 722	607.00
	0 - 500	0 - 20	100	4.0	0.01	.0005	0.06	1348 728	778.00



1998720

1998501

1997501

### Accessories

	Order no.	List price
Battery, 3V-Lithium, CR 2032	0220 704	3.90
Data cable DATA VARIABLE to RS232	1997 501	50.00
Data cable DATA VARIABLE to digimatic	1998 501	64.00
Data cable DATA VARIABLE to USB	1998 720	72.00



## 0250 Contraction vernier calipers

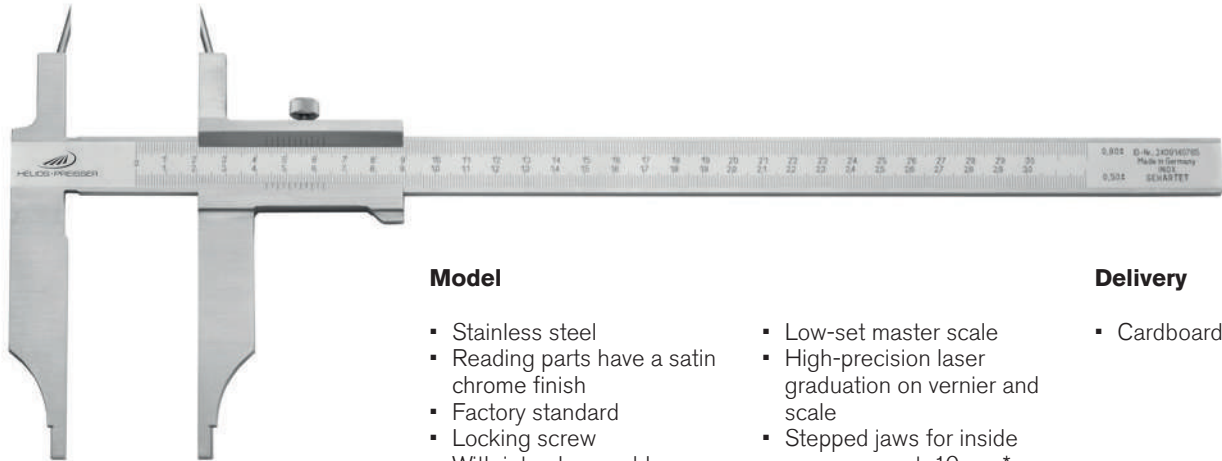

### Model

- Stainless steel
- Reading parts have a satin chrome finish
- Factory standard
- Locking screw
- With interchangeable hardened scribing jaws

### Delivery

- Cardboard box

☒ ☒	Measuring range mm	Jaw length mm	Reading mm	Order no.	List price EUR
	<b>Direct reading for internal and external measurement</b>				
	0 - 300	90	0.05	0250 501	255.00
	<b>Contraction scale divisions 1.0% - 1.5% - 2.0% - 1/1 mm</b>				
	0 - 300	90	0.1	0250 511	275.00
	<b>Contraction scale divisions 0.5% - 0.8% - 1.0% - 1/1 mm</b>				
	0 - 300	90	0.1	0250 521	275.00
	<b>Contraction scale divisions 1.0% - 1.25% - 1.5% - 1/1 mm</b>				
	0 - 300	90	0.1	0250 531	275.00
	<b>Contraction scale divisions 1.75% - 2.0% - 2.5% - 1/1 mm</b>				
	0 - 300	90	0.1	0250 541	275.00
	<b>Contraction scale divisions 1.0% - 1.25% - 2.0% - 1/1 mm</b>				
	0 - 300	90	0.1	0250 551*	275.00
	<b>Contraction scale divisions 0.3% - 0.4% - 0.6% - 1/1 mm</b>				
	0 - 300	90	0.1	0250 561*	275.00
	<b>Contraction scale divisions 1.0% - 1.25% - 1.5% - 2.0%</b>				
	0 - 300	90	0.1	0250 571*	289.00

## 0250 Interchangeable points (pair) for contraction vernier calipers



### Model

- Ø 3.0 mm and Ø 4.0 mm

☒ ☒	Description	Order no.	List price EUR
	For measuring range 300 mm, steel, hardened	0250 101	5.90
	For measuring range 500 + 600 mm, steel, hardened	0250 102	11.90
	For measuring range 800 + 1000 mm, steel, hardened	0250 103*	16.30
	For measuring range 300 mm, carbide	0250 201	59.00
	For measuring range 500 + 600 mm, carbide	0250 202	85.00



## 1320 DIGI-MET® Pocket caliper with 40 mm inside cross points



DIN  
862



### Model

- Inductive measuring system, resistant to damp and sweat
- Stainless steel
- LCD display 7.5 mm
- DIN 862
- Locking screw
- Inside cross points
- Four way measurement

### Functions

- ON / OFF
- **Quick-Start**
- **Quick-Lock** (key lock)
- Set to zero at any point
- mm / inch switching
- Variable data output RS 232 + Digimatic + USB

### Delivery

- Plastic case

✕	☒	Measuring range		Jaw length		Reading		Error limit	Depth gauge	Order no.	List price
		mm	inch	mm	inch	mm	inch	mm	dia. mm		EUR
<b>With DATA VARIABLE, with extra long cross points (40 mm)</b>											
▪		0 - 150	0 - 6	40	1.6	0.01	.0005	0.03	round 1.5	1320 518	395.00



1998720



1998501



1997501

### Accessories

	Order no.	List price
Battery, 3V-Lithium, CR 2032	0220 704	3.90
Data cable DATA VARIABLE to digimatic	1998 501	64.00
Data cable DATA VARIABLE to RS232	1997 501	50.00
Data cable DATA VARIABLE to USB	1998 720	72.00



# HELIOS · PREISSER

## 0262 Caliper for external locking grooves

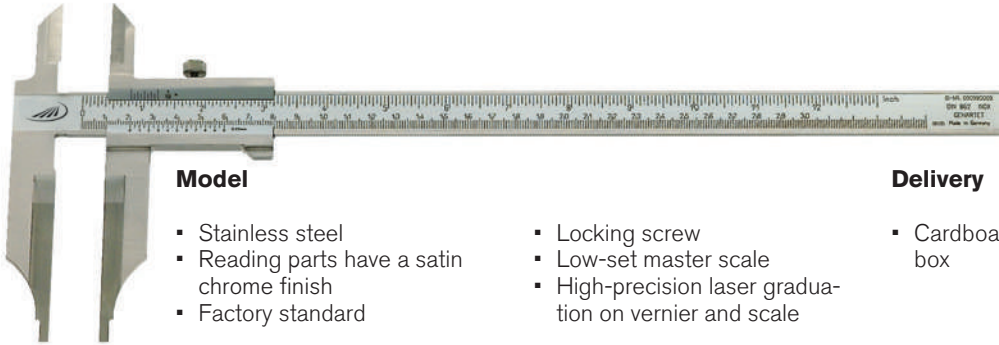

### Model

- Stainless steel
- Reading parts have a satin chrome finish
- Factory standard
- Locking screw
- Low-set master scale
- High-precision laser graduation on vernier and scale

### Delivery

- Cardboard box

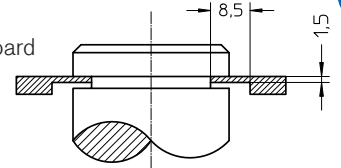

✕	Measuring range		Jaw length		Reading		Error limit	Order no.	List price
	mm	inch	mm	inch	mm	inch			
	0 - 300	0 - 12	90	3.5	0.05	1/128	0.03	0262 503	EUR 271.00

## 1353 DIGI-MET® Caliper for external locking grooves

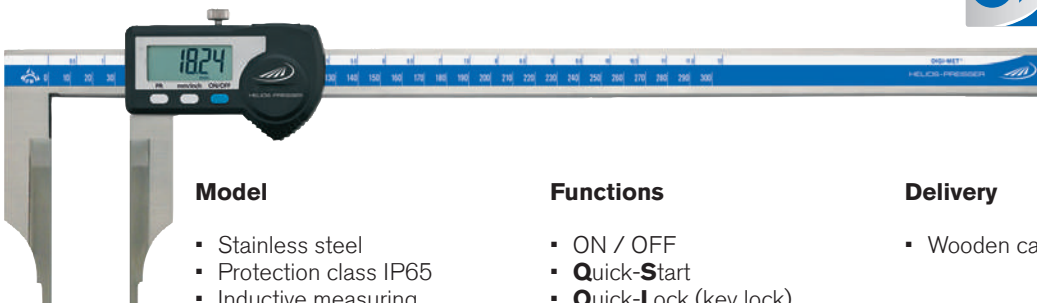

### Model

- Stainless steel
- Protection class IP65
- Inductive measuring system
- LCD display 10 mm
- Locking screw
- Factory standard

### Functions

- ON / OFF
- Quick-Start
- Quick-Lock (key lock)
- Set to zero at any point
- mm / inch switching
- PRESET-Function (setting a numerical value)
- Variable data output RS 232 + Digimatic + USB

### Delivery

- Wooden case

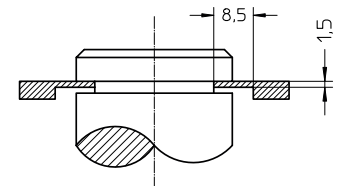

✕	Measuring range		Jaw length		Reading		Error limit	Order no.	List price
	mm	inch	mm	inch	mm	inch			
	0 - 300	0 - 12	90	3.5	0.01	.0005	0.03	1353 522	EUR 491.00



1998720      1997501      1998501

### Accessories

	Order no.	List price
Battery, 3V-Lithium, CR 2032	0220 704	EUR 3.90
Data cable DATA VARIABLE to RS232	1997 501	50.00
Data cable DATA VARIABLE to digimatic	1998 501	64.00
Data cable DATA VARIABLE to USB	1998 720	72.00



## 0252 Brake drum vernier calipers

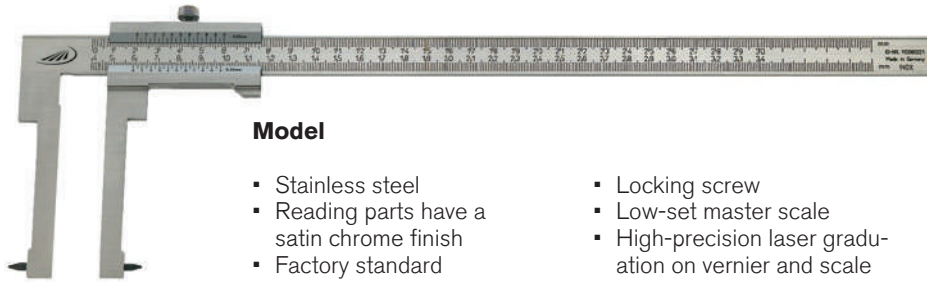

### Model

- Stainless steel
- Reading parts have a satin chrome finish
- Factory standard
- Locking screw
- Low-set master scale
- High-precision laser graduation on vernier and scale

### Delivery

- Cardboard box

✂	📏	Measuring range internal mm	Measuring range external mm	Jaw length mm	Reading mm	Error limit mm	Order no.	List price EUR
		40 - 300	0 - 300	90	0.05	0.1	0252 201	143.00
		50 - 500	0 - 500	150	0.05	0.14	0252 202	275.00
		50 - 600	0 - 600	200	0.05	0.16	0252 203	301.00

## 0252 Replacement points (pair) for brake drum vernier calipers



✂	📏	Description	Order no.	List price EUR
		For measuring range 300 mm	0252 291	4.40
		For measuring range 500 + 600 mm	0252 293	5.40

## 0253 Brake disc inspection gauges

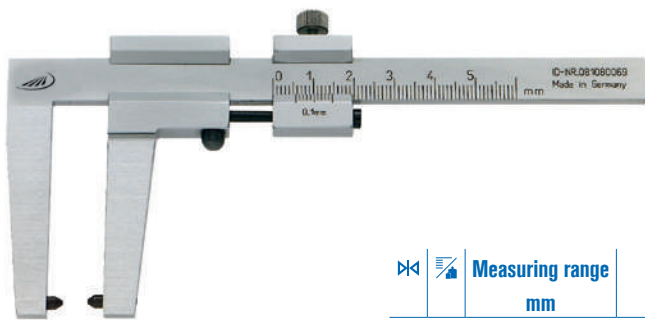

### Model

- Special steel
- Reading parts have a satin chrome finish
- Factory standard
- Locking screw
- With trailing vernier
- High-precision laser graduation on vernier and scale

### Delivery

- Cardboard box

✂	📏	Measuring range mm	Jaw length mm	Reading mm	Error limit mm	Order no.	List price EUR
<b>For motorcycles</b>							
		0 - 50	30	0.1	0.1	0253 300	84.00
<b>For cars</b>							
		0 - 50	50	0.1	0.14	0253 301	84.00
<b>For trucks</b>							
		0 - 80	50	0.1	0.16	0253 302	107.00

## 0253 Replacement points (pair) for brake disc inspection gauges



✂	📏	Order no.	List price EUR
		0253 391	3.90



# HELIOS · PREISSER

## 1352 DIGI-MET® Calipers for internal grooves



### Model

- Stainless steel
- LCD display 7.5 mm
- Factory standard
- Locking screw
- Protection class IP65

### Functions

- ON / OFF
- **Quick-Start**
- **Quick-Lock** (key lock)
- Set to zero at any point
- mm / inch switching
- PRESET-Function (setting a numerical value)

- Variable data output RS 232 + Digimatic + USB

### Delivery

- Wooden case

Measuring range	Jaw length		Reading		Error limit	Order no.	List price
	mm	mm	inch	mm			
10 - 160	25	1.0	0.01	.0005	0.06	1352 516	388.00
20 - 160	40	1.5	0.01	.0005	0.06	1352 517	437.00
26 - 200	60	2.3	0.01	.0005	0.06	1352 518	800.00
30 - 250	80	3.1	0.01	.0005	0.06	1352 520	900.00
35 - 300	100	3.9	0.01	.0005	0.06	1352 522	939.00

## 0258 Calipers for internal grooves

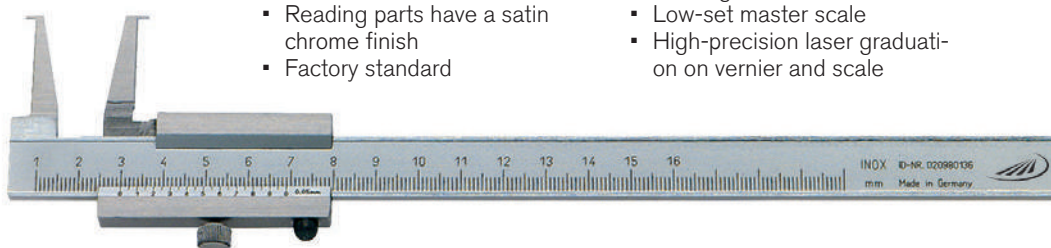

### Model

- Stainless steel
- Reading parts have a satin chrome finish
- Factory standard

### Delivery

- Cardboard box

Measuring range	Jaw length		Reading	Error limit	Order no.	List price
	mm	mm				
10 - 160	25	1.0	0.05	0.1	0258 501	144.00
20 - 160	40	1.5	0.05	0.1	0258 502	192.00
26 - 200	60	2.3	0.05	0.1	0258 503	295.00
30 - 250	80	3.1	0.05	0.1	0258 504	333.00
35 - 300	100	3.9	0.05	0.1	0258 505	372.00

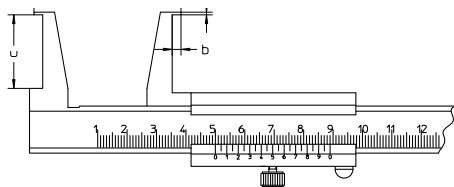

Measuring range mm	a	b	c
10 - 160	0.9	3.0	25
20 - 160	2.0	5.0	40
26 - 200	3.0	7.0	60
30 - 250	4.0	8.5	80
35 - 300	5.0	10.0	100



## 0260 Calipers for 3/5 point measurement

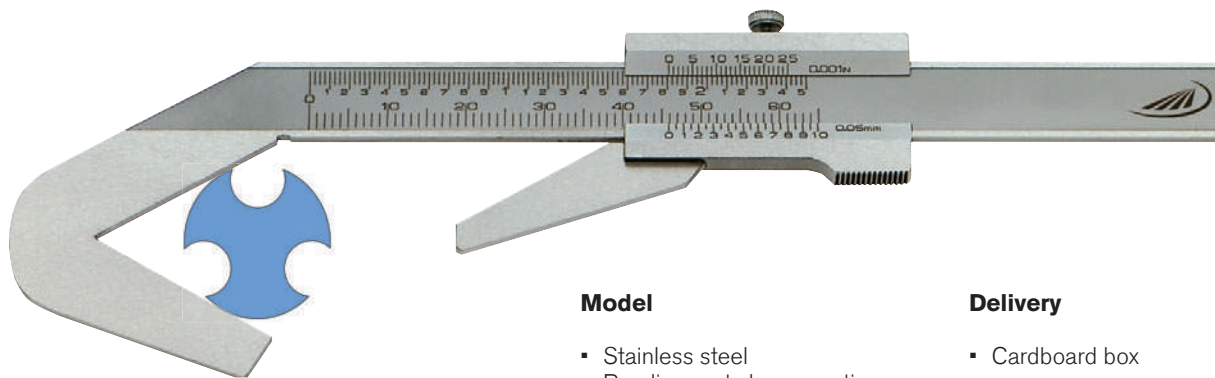

### Model

- Stainless steel
- Reading parts have a satin chrome finish
- Locking screw
- Factory standard

### Delivery

- Cardboard box

Marked	Icon	Measuring range	Reading		Error limit	Order no.	List price EUR
		mm	mm	inch	mm		
		<b>3 point measurement</b>					
		4 - 40	0.05	1/128	0.05	0260 501	74.00
		<b>5 point measurement</b>					
		2 - 40	0.05	1/128	0.05	0260 502	74.00

## 0268 Milling tool caliper

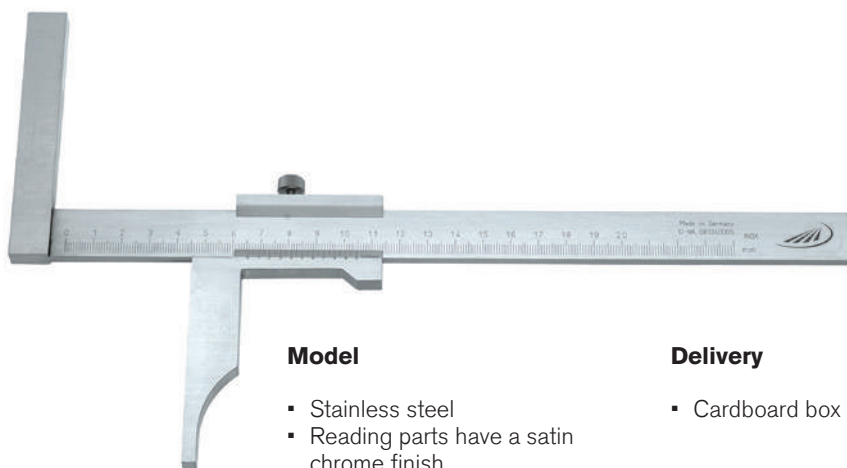

### Model

- Stainless steel
- Reading parts have a satin chrome finish
- Factory standard
- Setting of milling cutters, can be used as height gauge

### Delivery

- Cardboard box

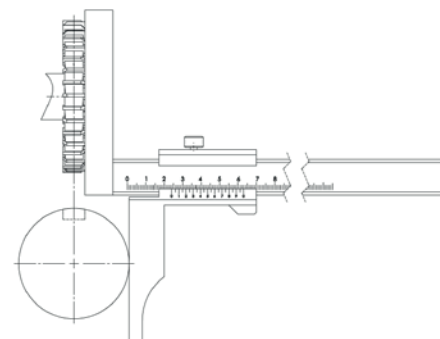

Marked	Icon	Measuring range	Jaw length	Reading	Error limit	Order no.	List price EUR
		mm	mm	mm	mm		
		0 - 200	80	0.05	0.05	0268 518	182.00
		0 - 300	80	0.05	0.05	0268 522	195.00



## 0597 Chamfer gauge

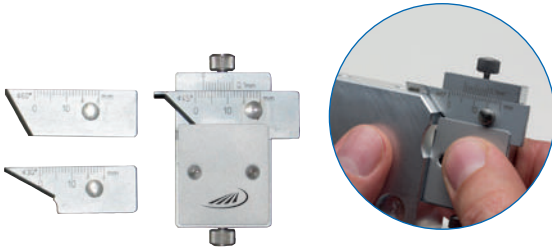

### Model

- Stainless steel
- Reading 0.1 mm
- Reading parts have a satin chrome finish
- For simultaneously testing of the chamfer angle and the dimensional accuracy
- Dimensions: 48 x 30 x 8.5 mm

### Delivery

- 3 interchangeable blades: 30°, 45°, 60°
- Wooden case

Icon	Measuring range	Reading	Order no.	List price
	mm	mm		EUR
	0 - 10	0.10	0597 301	175.00

1

## 0597 Radius gauge



### Model

- To determine radius size workpieces
- Stainless steel
- Reading parts are satin chrome finished

### Delivery

- Wooden case

Icon	Measuring range	Reading	Order no.	List price
	mm	mm		EUR
	0 - 10	0.10	0597 305	175.00





## 0268 Gear tooth calipers

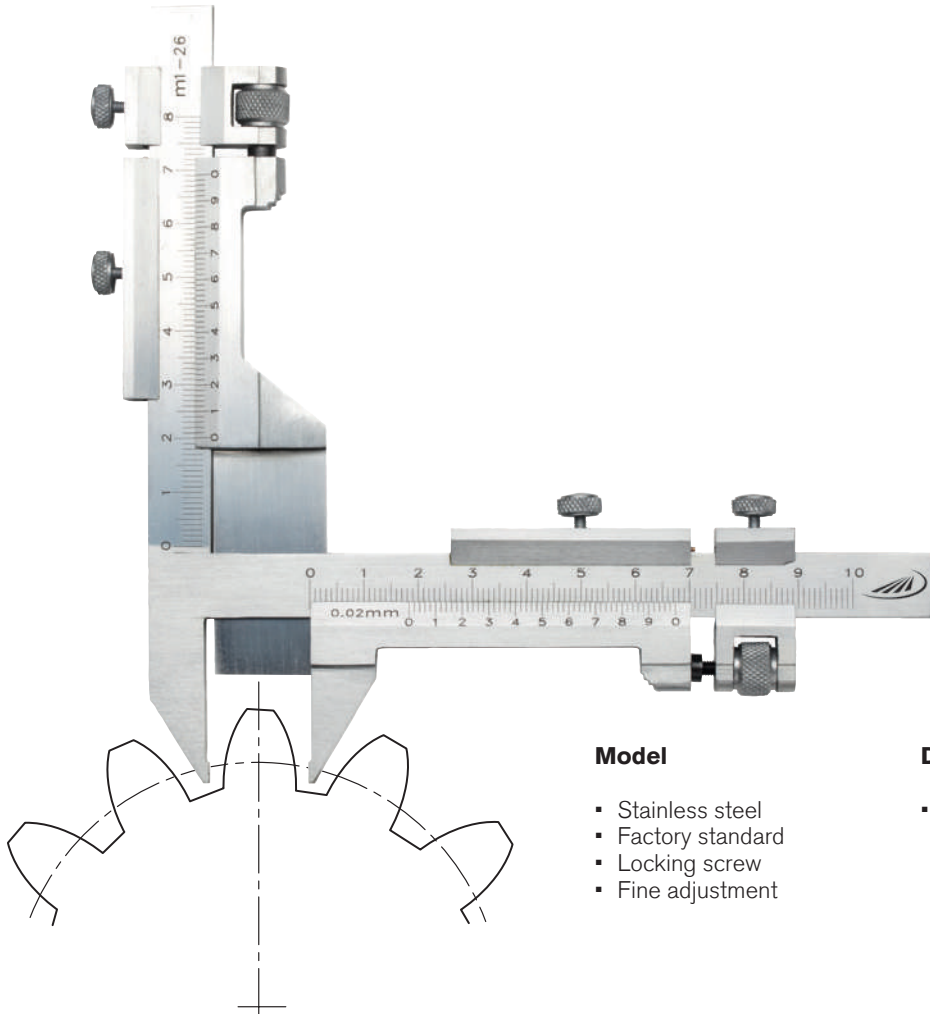

### Model

- Stainless steel
- Factory standard
- Locking screw
- Fine adjustment

### Delivery

- Wooden case

✂	🏠	Module	Reading mm	Error limit mm	Order no.	List price EUR
<b>Hardened jaw tips</b>						
		1 - 26	0.02	0.1	0268 201	308.00
<b>Carbide tipped jaw tips</b>						
		1 - 26	0.02	0.1	0268 211	376.00



## 0280 / 0281 Vernier depth gauges



**DIN  
862**

**1**



0280 501

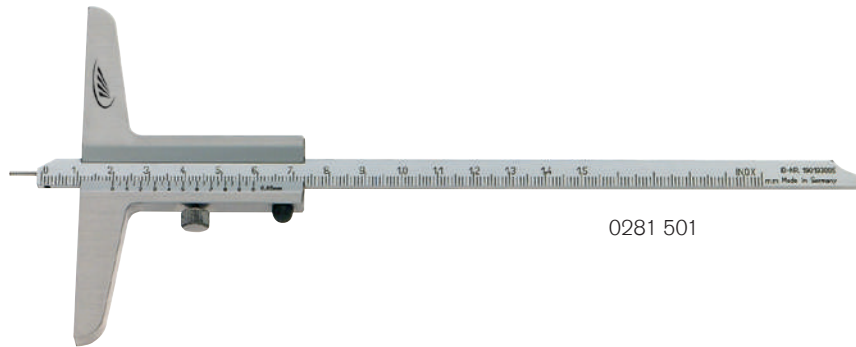

0281 501

### Model

- Stainless steel
- Reading parts have a satin chrome finish
- DIN 862
- Low-set master scale
- Locking screw
- Measuring rod with interchangeable pin
- Double sided scale
- High-precision laser graduation on vernier and scale

### Delivery

- Cardboard box

Icon	Measuring range mm	Length of beam mm	Reading mm	Error limit mm	Order no.	List price EUR
<b>Vernier satin chrome finished, measuring rod with interchangeable pin</b>						
▪	0 - 80	50	0.05	0.05	0280 501	61.00
<b>Vernier satin chrome finished, reversible measuring rod with interchangeable pin</b>						
▪	0 - 150	100	0.05	0.05	0281 201	81.00
▪	0 - 200	100	0.05	0.05	0281 202	84.00
▪	0 - 250	130	0.05	0.05	0281 204	94.00
▪	0 - 300	150	0.05	0.05	0281 205	106.00
<b>Vernier + scale satin chrome finished, reversible measuring rod with interchangeable pin</b>						
▪	0 - 150	100	0.05	0.05	0281 501	89.00
▪	0 - 200	100	0.05	0.05	0281 502	92.00
▪	0 - 250	130	0.05	0.05	0281 504	105.00
▪	0 - 300	150	0.05	0.05	0281 505	115.00

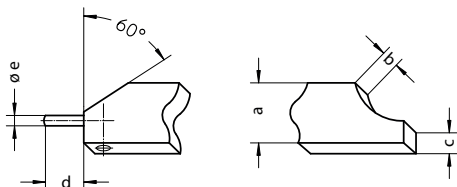

Measuring range mm	a	b	c	d	e
0 - 80	8.0	3.0	-	6.0	1.0
150 - 200	8.0	3.0	3.5	8.0	1.5
250 - 300	12.0	4.0	4.0	8.0	2.0



## 0282 Vernier depth gauges



**DIN  
862**

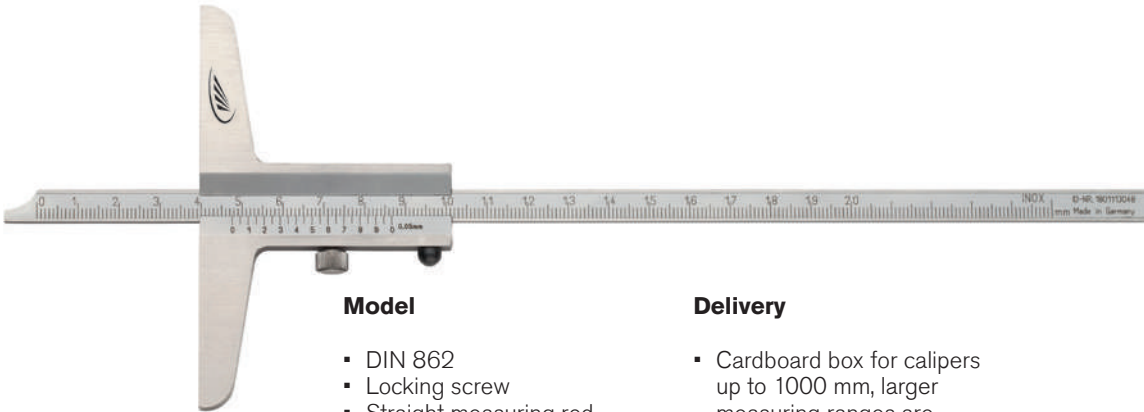

### Model

- DIN 862
- Locking screw
- Straight measuring rod
- Low-set master scale
- High-precision laser graduation on vernier and scale

### Delivery

- Cardboard box for calipers up to 1000 mm, larger measuring ranges are individually packed

✕	Measuring range mm	Length of beam mm	Reading mm	Error limit mm	Order no.	List price EUR
<b>Stainless steel, vernier satin chrome finished</b>						
▪	0 - 150	100	0.05	0.05	0282 201	72.00
▪	0 - 200	100	0.05	0.05	0282 202	74.00
▪	0 - 300	100	0.05	0.05	0282 203	85.00
▪	0 - 250	130	0.05	0.05	0282 204	82.00
▪	0 - 300	150	0.05	0.05	0282 205	90.00
▪	0 - 400	150	0.05	0.06	0282 206	101.00
▪	0 - 500	150	0.05	0.07	0282 207	139.00
▪	0 - 500	250	0.05	0.07	0282 208	214.00
▪	0 - 800	250	0.05	0.10	0282 209	352.00
▪	0 - 1000	250	0.05	0.12	0282 210	500.00
▪	0 - 1500	300	0.05	0.18	0282 212	1221.00
▪	0 - 2000	300	0.05	0.22	0282 213	1605.00
<b>Stainless steel, vernier + scale satin chrome finished</b>						
▪	0 - 150	100	0.05	0.05	0282 501	78.00
▪	0 - 200	100	0.05	0.05	0282 502	82.00
▪	0 - 300	100	0.05	0.05	0282 503	93.00
▪	0 - 250	130	0.05	0.05	0282 504	90.00
▪	0 - 300	150	0.05	0.05	0282 505	99.00
▪	0 - 400	150	0.05	0.06	0282 506	112.00
▪	0 - 500	150	0.05	0.07	0282 507	152.00
▪	0 - 500	250	0.05	0.07	0282 508	232.00
▪	0 - 800	250	0.05	0.10	0282 509	387.00
▪	0 - 1000	250	0.05	0.12	0282 510	548.00

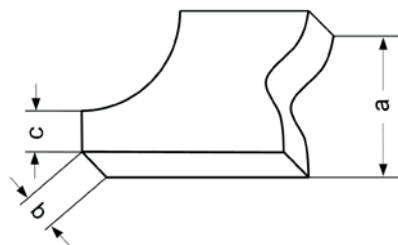

Measuring range mm	a	b	c
150 - 200	8.0	3.0	3.5
250 - 500	12.0	4.0	4.0
500 - 1000	20.0	5.0	10.0
1500	25.0	6.0	13.0
2000	30.0	7.0	13.0



## 0286 Vernier depth gauges



**DIN  
862**

**1**



Reversible measuring rod

### Model

- DIN 862
- Locking screw
- Reversible, L-shaped measuring rod
- Scales on both sides
- Low-set master scale

### Delivery

- High-precision laser graduation on vernier and scale
- Cardboard box for calipers up to 1000 mm, larger measuring ranges are individually packed

Measuring range mm	Length of beam mm	Reading mm	Error limit mm	Order no.	List price EUR
<b>Stainless steel, vernier satin chrome finished</b>					
0 - 150	100	0.05	0.05	0286 201	85.00
0 - 200	100	0.05	0.05	0286 202	88.00
0 - 250	130	0.05	0.05	0286 204	99.00
0 - 300	150	0.05	0.05	0286 205	106.00
0 - 400	150	0.05	0.06	0286 206	131.00
0 - 500	150	0.05	0.07	0286 207	167.00
0 - 500	250	0.05	0.07	0286 208	279.00
0 - 800	250	0.05	0.10	0286 209	438.00
0 - 1000	250	0.05	0.12	0286 210	607.00
0 - 1500	300	0.05	0.18	0286 212	1312.00
0 - 2000	300	0.05	0.22	0286 213	1691.00
<b>Stainless steel, vernier + scale satin chrome finished</b>					
0 - 150	100	0.05	0.05	0286 501	93.00
0 - 200	100	0.05	0.05	0286 502	94.00
0 - 250	130	0.05	0.05	0286 504	108.00
0 - 300	150	0.05	0.05	0286 505	115.00
0 - 400	150	0.05	0.06	0286 506	142.00
0 - 500	150	0.05	0.07	0286 507	184.00
0 - 500	250	0.05	0.07	0286 508	388.00
0 - 800	250	0.05	0.10	0286 509	523.00
0 - 1000	250	0.05	0.12	0286 510	666.00

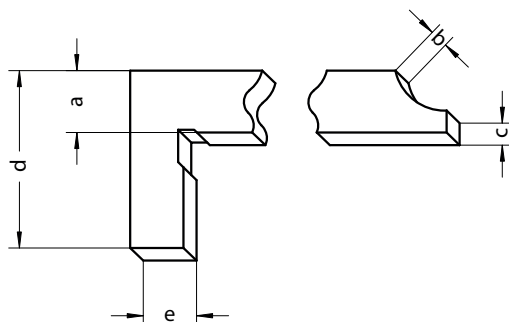

Measuring range mm	a	b	c	d	e
150 - 200	8.0	3.0	3.5	20.0	5.0
250 - 500	12.0	4.0	4.0	28	10
500 - 1000	20.0	5.0	10.0	70.0	19.0
1500	25.0	6.0	13.0	90.0	24.0
2000	30.0	7.0	13.0	90.0	29.0



## 0292 Offset vernier depth gauges

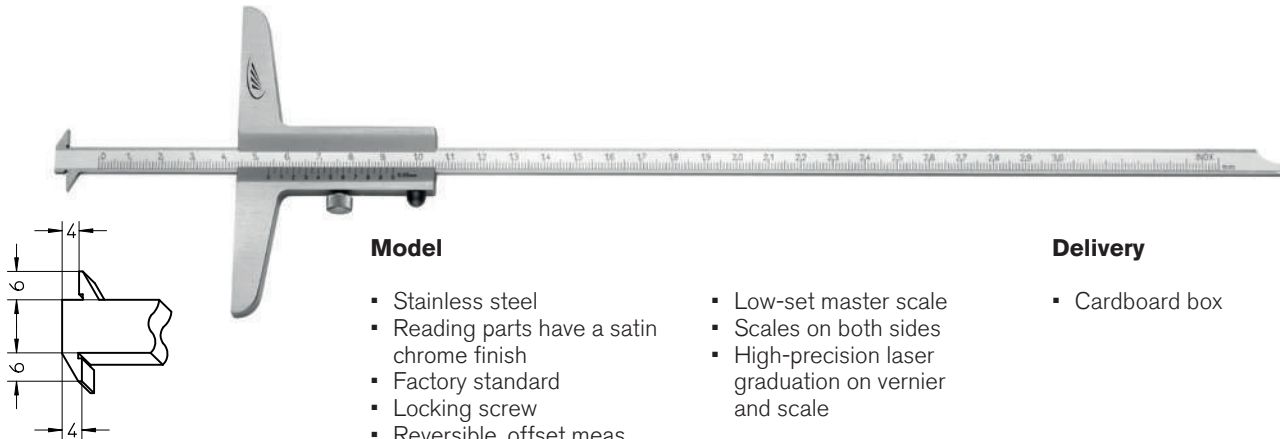

### Model

- Stainless steel
- Reading parts have a satin chrome finish
- Factory standard
- Locking screw
- Reversible, offset meas. rod
- Low-set master scale
- Scales on both sides
- High-precision laser graduation on vernier and scale

### Delivery

- Cardboard box

Measuring range	Length of beam	Reading	Error limit	Order no.	List price
mm	mm	mm	mm		EUR
0 - 200	100	0.05	0.05	0292 501	88.00
0 - 300	100	0.05	0.05	0292 502	100.00

## 0294 Vernier depth gauges with sliding measuring base

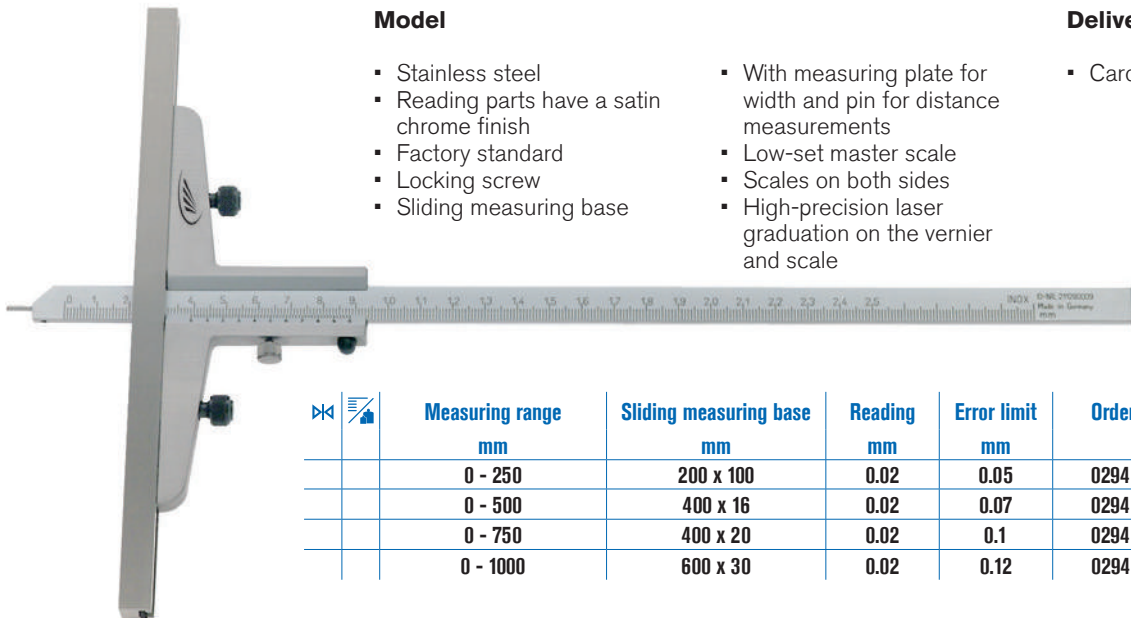

### Model

- Stainless steel
- Reading parts have a satin chrome finish
- Factory standard
- Locking screw
- Sliding measuring base
- With measuring plate for width and pin for distance measurements
- Low-set master scale
- Scales on both sides
- High-precision laser graduation on the vernier and scale

### Delivery

- Cardboard box

Measuring range	Sliding measuring base	Reading	Error limit	Order no.	List price
mm	mm	mm	mm		EUR
0 - 250	200 x 100	0.02	0.05	0294 504	470.00
0 - 500	400 x 16	0.02	0.07	0294 505	750.00
0 - 750	400 x 20	0.02	0.1	0294 506	1166.00
0 - 1000	600 x 30	0.02	0.12	0294 507	1581.00

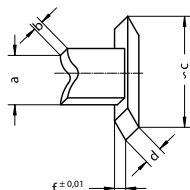
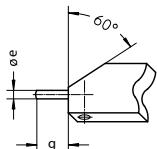

Measuring range	a	b	c	d	e	f	g
mm							
250 - 500	12.0	4.0	18.0	6.0	2.0	2.0	8.0
750 - 1000	20.0	5.0	30.0	8.0	3.0	3.0	8.0



## 1360 DIGI-MET® Depth gauges

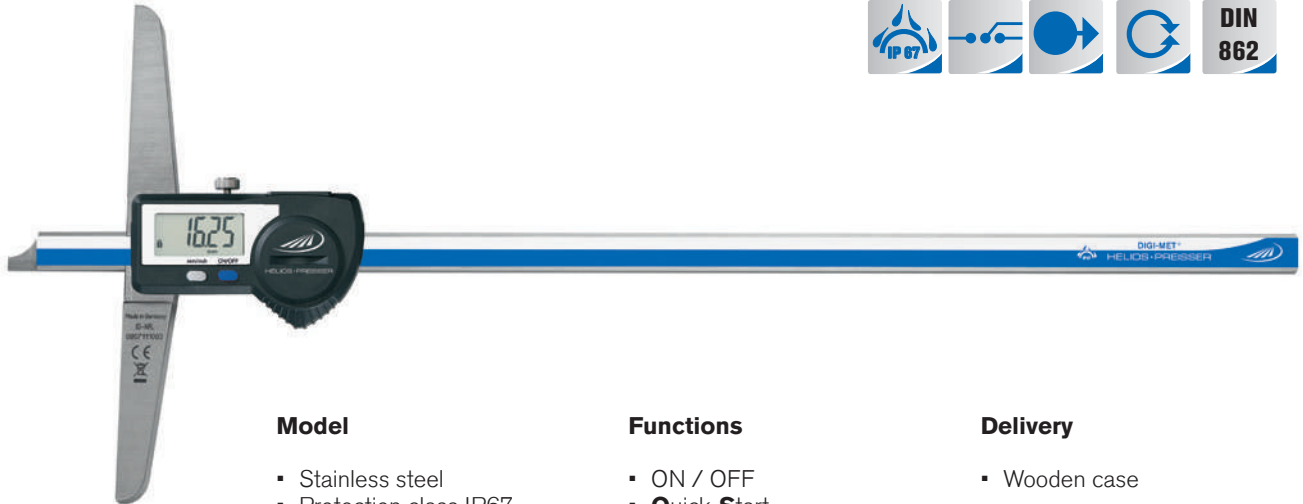

### Model

- Stainless steel
- Protection class IP67
- From 1000 mm protection class IP65
- LCD display 7.5 mm
- DIN 862
- Locking screw
- Straight measuring rod

### Functions

- ON / OFF
- **Quick-Start**
- **Quick-Lock** (key lock)
- Set to zero at any point
- mm / inch switchin
- Variable data output RS 232 + Digimatic + USB

### Delivery

- Wooden case

▶	Measuring range		Length of beam	Reading		Error limit	Order no.	List price
	mm	inch		mm	inch			
▪	0 - 150	0 - 6	100	0.01	.0005	0.03	1360 716	329.00
▪	0 - 200	0 - 8	100	0.01	.0005	0.03	1360 718	373.00
▪	0 - 300	0 - 12	150	0.01	.0005	0.03	1360 722	419.00
▪	0 - 500	0 - 20	150	0.01	.0005	0.03	1360 728	481.00
▪	0 - 1000	0 - 39	250	0.01	.0005	0.04	1360 734	1370.00
▪	0 - 1500	0 - 59	250	0.01	.0005	0.05	1360 738	2090.00
▪	0 - 2000	0 - 80	250	0.01	.0005	0.06	1360 740	2481.00



### Accessories

	Order no.	List price
		EUR
Battery, 3V-Lithium, CR 2032	0220 704	3.90
Data cable DATA VARIABLE to RS232	1997 501	50.00
Data cable DATA VARIABLE to digimatic	1998 501	64.00
Data cable DATA VARIABLE to USB	1998 720	72.00



## 1362 DIGI-MET® Depth gauges

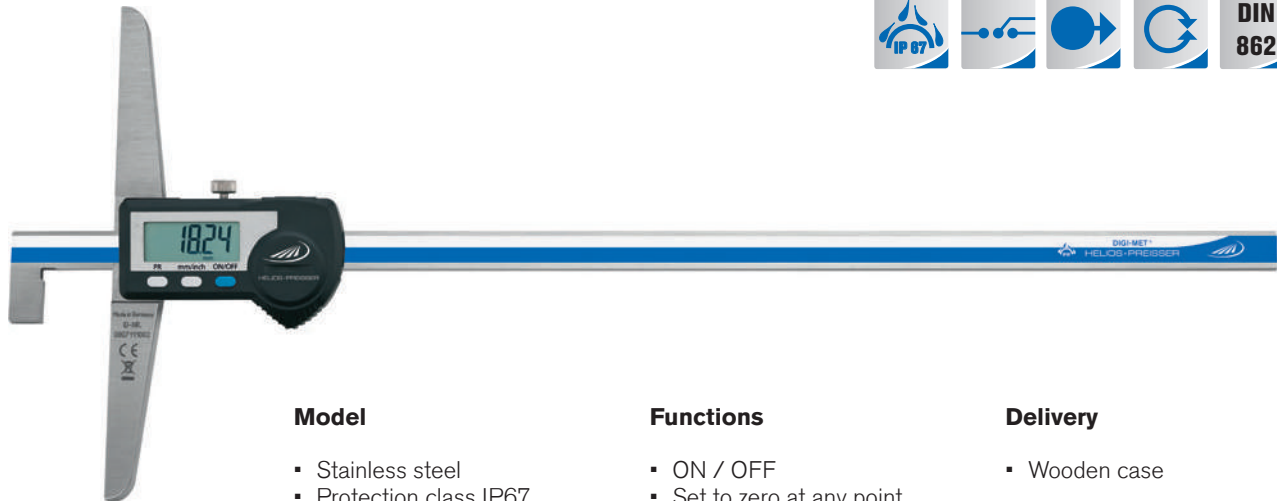

### Model

- Stainless steel
- Protection class IP67
- LCD display 7,5 mm
- DIN 862
- Locking screw
- L-shaped measuring rod
- Larger measuring ranges are available upon request

### Functions

- ON / OFF
- Set to zero at any point
- mm / inch switching
- **Quick-Start**
- **Quick-Lock** (key lock)
- PRESET-Function (setting a numerical value)
- Variable data output RS 232 + Digimatic + USB

### Delivery

- Wooden case

Marked	Measuring range		Length of beam mm	Reading		Error limit mm	Order no.	List price EUR
	mm	inch		mm	inch			
▪	0 - 300	0 - 12	150	0.01	.0005	0.03	1362 722	429.00
▪	0 - 500	0 - 20	150	0.01	.0005	0.03	1362 728	499.00



1998720

1997501

1998501

### Accessories

Battery, 3V-Lithium, CR 2032

Data cable DATA VARIABLE to RS232

Data cable DATA VARIABLE to digimatic

Data cable DATA VARIABLE to USB

### Order no.

0220 704

1997 501

1998 501

1998 720

### List price

EUR

3.90

50.00

64.00

72.00

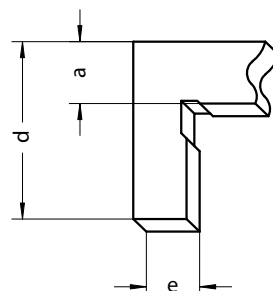

Measuring range mm	a	e	d
300	11.6	10	28
500	11.6	10	28



## 1364 DIGI-MET® Depth gauges

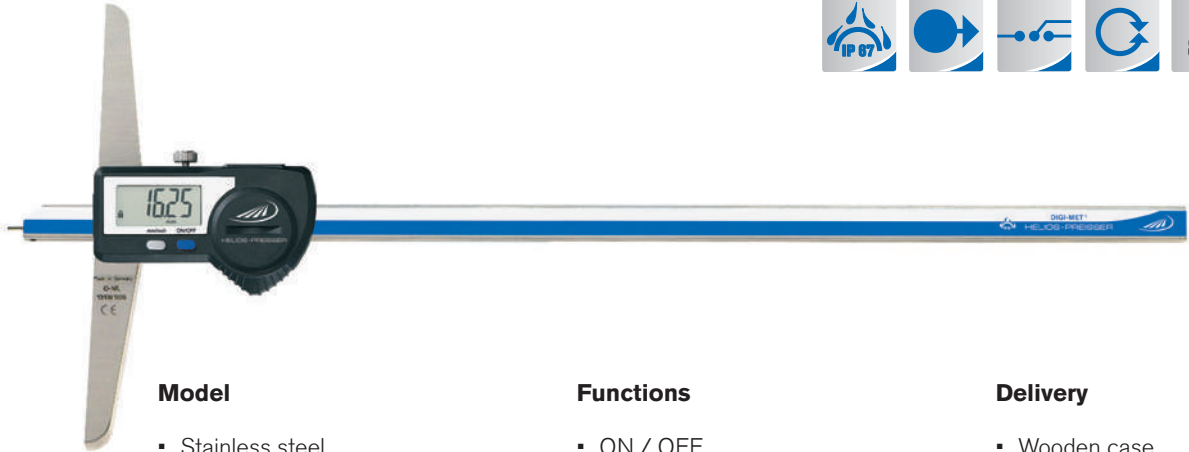

1

### Model

- Stainless steel
- Protection class IP67
- LCD display 7.5 mm
- DIN 862
- Locking screw
- Replaceable pin
- Larger measuring ranges are available upon request

### Functions

- ON / OFF
- **Quick-Start**
- **Quick-Lock** (key lock)
- Set to zero at any point
- mm / inch switching
- Variable data output RS 232 + Digimatic + USB

### Delivery

- Wooden case

▣	Measuring range		Length of beam mm	Reading		Error limit mm	Order no.	List price EUR
	mm	inch		mm	inch			
▪	0 - 200	0 - 8	100	0.01	.0005	0.03	1364 722	406.00
▪	0 - 300	0 - 12	150	0.01	.0005	0.03	1364 728	452.00

### Accessories



1998720

1997501

1998501

	Order no.	List price EUR
Battery, 3V-Lithium, CR 2032	0220 704	3.90
Data cable DATA VARIABLE to RS232	1997 501	50.00
Data cable DATA VARIABLE to digimatic	1998 501	64.00
Data cable DATA VARIABLE to USB	1998 720	72.00

## 0276 Replacement measuring pin



▣	Diameter mm	Order no.	List price EUR
▪	2	0276 711	6.40





## 1366 DIGI-MET® Offset depth gauges

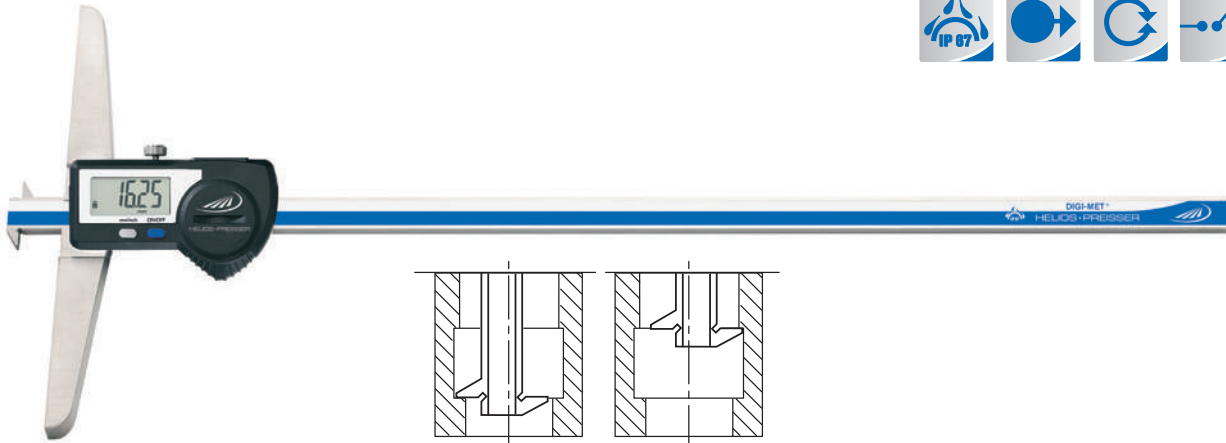

### Model

- Stainless steel
- Inductive measuring system, protection class IP67
- LCD display 7,5 mm
- Factory standard
- Housing and operating keys have an excellent chemical resistance
- Locking screw

### Functions

- ON / OFF
- **Quick-Start**
- **Quick-Lock** (key lock)
- Set to zero at any point
- mm / inch switching
- Variable data output RS 232 + Digimatic + USB

### Delivery

- Wooden case

Marked	Measuring range		Length of beam	Reading		Error limit	Order no.	List price
	mm	inch		mm	inch			
▪	0 - 200	0 - 8	100	0.01	.0005	0.03	1366 718	422.00
▪	0 - 300	0 - 12	150	0.01	.0005	0.03	1366 722	510.00
▪	0 - 500	0 - 20	150	0.01	.0005	0.03	1366 728	642.00



1998720

1997501

1998501

### Accessories

Battery, 3V-Lithium, CR 2032

Data cable DATA VARIABLE to RS232

Data cable DATA VARIABLE to digimatic

Data cable DATA VARIABLE to USB

### Order no.

0220 704

1997 501

1998 501

1998 720

### List price

EUR

3.90

50.00

64.00

72.00

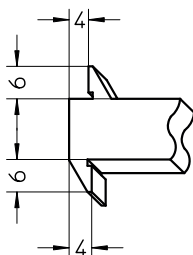



## 1368 DIGI-MET® Depth gauges

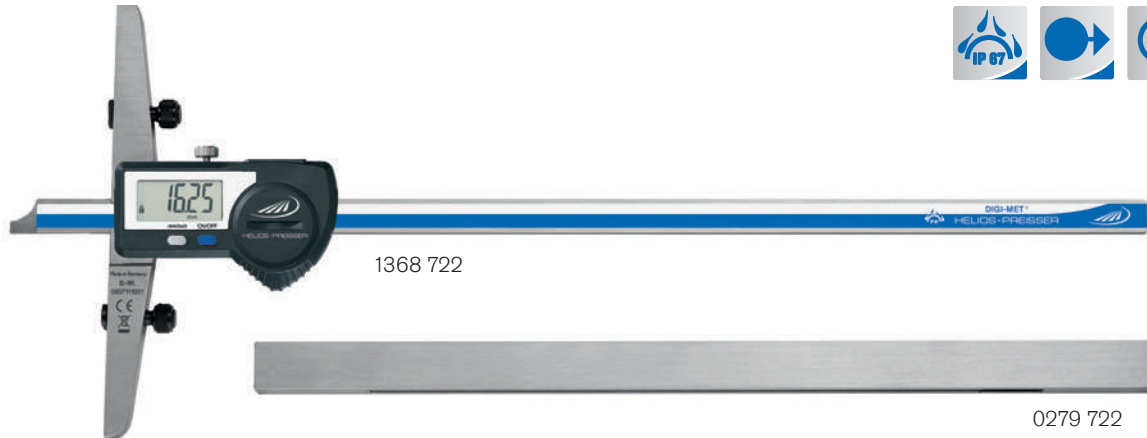

1

### Model

- Stainless steel
- Inductive measuring system, protection class IP67
- LCD display 7.5 mm
- Locking screw

### Functions

- ON / OFF
- **Quick-Start**
- **Quick-Lock** (key lock)
- Set to zero at any point
- mm / inch switching
- Variable data output RS 232 + Digimatic + USB

### Delivery

- Wooden box
- **The sliding measuring base must be ordered separately**

Icon	Measuring range		Length of beam mm	Reading		Error limit mm	Order no.	List price EUR
	mm	inch		mm	inch			
	0 - 300	0 - 12	150	0.01	.0005	0.03	1368 722	429.00
	0 - 500	0 - 20	150	0.01	.0005	0.03	1368 728	489.00



1998720

1997501

1998501

### Accessories

	Order no.	List price EUR
Battery, 3V-Lithium, CR 2032	0220 704	3.90
Data cable DATA VARIABLE to RS232	1997 501	50.00
Data cable DATA VARIABLE to digimatic	1998 501	64.00
Data cable DATA VARIABLE to USB	1998 720	72.00

## 0279 Sliding measuring base made of stainless steel



### Delivery

- Bolts included

Icon	Dimensions mm	Order no.	List price EUR
	400 x 16	0279 723	284.00
	500 x 16	0279 724	296.00

### Accessories

	Order no.	List price EUR
Fixture for sliding measuring base, two parts	0279 792	21.50



## 1371i DIGI-MET® Depth gauges IP67 with integrated wireless



1371 41660

## integrated IW wireless

Wireless Data Transmission

### Model

- Stainless steel
- Inductive measuring system, protection class IP67
- DIN 862
- Locking screw
- LCD display 11 mm
- Measuring pin dia. 1.5 mm

### Functions

- ON / OFF
- **Quick-Start**
- **Quick-Lock** (key lock)
- PRESET-Function (setting a numerical value)
- Set to zero at any point
- mm / inch switching
- Integrated Wireless

### Delivery

- Plastic case



More information on our i-series and Integrated Wireless on page 277

Marked *	Measuring range	Length of beam		Reading		Error limit	Order no.	List price
		mm	inch	mm	inch			
▪	0 - 150	0 - 6	100	0.01	.0005	0.03	1371 41660	432.00
▪	0 - 200	0 - 8	100	0.01	.0005	0.03	1371 41860	459.00
▪	0 - 300	0 - 12	150	0.01	.0005	0.04	1371 42260	516.00
▪	0 - 500	0 - 20	150	0.01	.0005	0.05	1371 42860	585.00



1998780

### Accessories

	Order no.	List price
Battery, 3V-Lithium, CR 2032	0220 704	3.90
i-Stick USB-receiver for Integrated Wireless	1998 780	95.00

Integrated Wireless is intended to be sold within the European Economic Area only



## 1371 DIGI-MET® Depth gauges IP67



1

### Model

- Stainless steel
- Inductive measuring system, protection class IP67
- DIN 862
- Locking screw
- LCD display 11 mm
- Measuring pin dia. 1.5 mm

### Functions

- ON / OFF
- **Quick-Start**
- **Quick-Lock** (key lock)
- PRESET-Function (setting a numerical value)
- Set to zero at any point
- mm / inch switching

### Delivery

- Plastic case



Product video

⊗	Measuring range		Length of beam mm	Reading		Error limit mm	Order no.	List price EUR
	mm	inch		mm	inch			
▪	0 - 150	0 - 6	100	0.01	.0005	0.03	1371 416	388.00
▪	0 - 200	0 - 8	100	0.01	.0005	0.03	1371 418	426.00
▪	0 - 300	0 - 12	150	0.01	.0005	0.04	1371 422	475.00
▪	0 - 500	0 - 20	150	0.01	.0005	0.05	1371 428	547.00

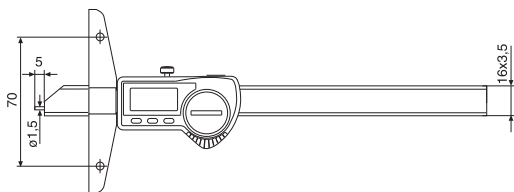

### Accessories

Battery, 3V-Lithium, CR 2032

Order no.	List price EUR
0220 704	3.90

## 1271 Extension depth attachment base



1271 451

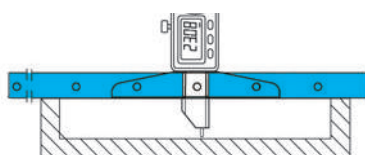

⊗	Measuring bridge length mm	Order no.	List price EUR
	200	1271 451	89.00
	300	1271 452	103.00

## 1271 Measuring insert for distance measurements

### Model

- To be attached to the measuring pin

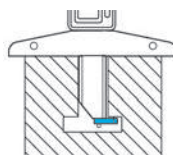

⊗	Order no.	List price EUR
	1271 455	59.00



## 1376 DIGI-MET® Depth gauge



### Example of use

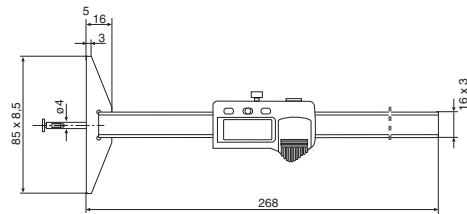
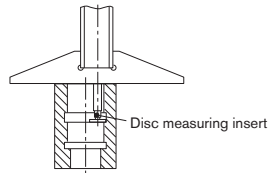
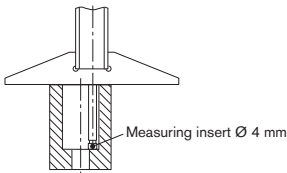

### Model

- Stainless steel
- Protection class IP67
- LCD display 7.5 mm
- Locking screw
- Factory standard

### Functions

- ON / OFF
- **Quick-Start**
- **Quick-Lock** (key lock)
- Set to zero at any point
- mm / inch switching
- Reversal of counting direction

- PRESET-Function (setting a numerical value)
- Variable data output RS 232 + Digimatic + USB

### Delivery

- Wooden case
- Disc type insert Ø 7.5 x 1 mm
- Inserts Ø 4 mm, flat and spherical

Measuring range	Length of beam		Reading		Error limit	Order no.	List price
	mm	inch	mm	inch			
0 - 100	0 - 4	85	0.01	.0005	0.02	1376 514	EUR 517.00



### Accessories

	Order no.	List price
Battery, 3V-Lithium, CR 2032	0220 704	3.90
Disc type measuring insert Ø 7.5 x 0.5 mm	1276 590	33.00
Disc type measuring insert Ø 7.5 x 1 mm	1276 591	18.80
Flat measuring insert Ø 4 mm	1276 592	18.00
Spherical measuring insert Ø 4 mm	1276 593	25.00
Data cable DATA VARIABLE to RS232	1997 501	50.00
Data cable DATA VARIABLE to digimatic	1998 501	64.00
Data cable DATA VARIABLE to USB	1998 720	72.00



## 1379 DIGI-MET® Depth gauges with interchangeable inserts

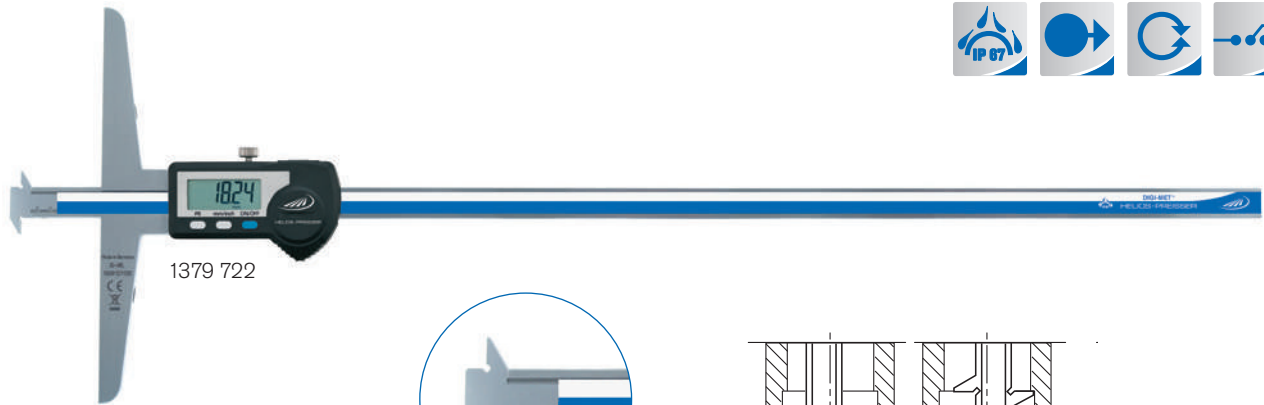

1379 722

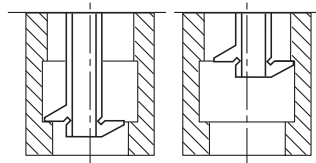
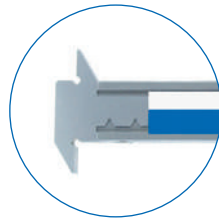

1

### Model

- Interchangeable inserts for solving different measuring tasks
- **Measuring base can be attached (optional, see accessories)**
- Stainless steel
- Inductive measuring system, protection class IP67
- Factory standard

### Functions

- ON / OFF
- **Quick-Start**
- **Quick-Lock** (key lock)
- PRESET-Function (setting a numerical value)
- Set to zero at any point
- mm / inch switching
- Variable data output RS 232 + Digimatic + USB

### Delivery

- Wooden case
- With inserts for width and distance measurements, Order no. 1279 780
- **More inserts and measuring base optional**

▶▶	Measuring range		Length of beam mm	Reading		Error limit mm	Order no.	List price EUR
	mm	inch		mm	inch			
▪	0 - 300	0 - 12	150	0.01	.0005	0.03	1379 722	663.00
▪	0 - 500	0 - 20	150	0.01	.0005	0.03	1379 728	914.00



1998720

1997501

1998501

Accessories	Order no.	List price EUR
Interchangeable inserts made of stainless steel, hardened		
Battery, 3V-Lithium, CR 2032	0220 704	3.90
Replacement cylinder screw M2x6	1379 790	8.90
Data cable DATA VARIABLE to RS232	1997 501	50.00
Data cable DATA VARIABLE to digimatic	1998 501	64.00
Data cable DATA VARIABLE to USB	1998 720	72.00

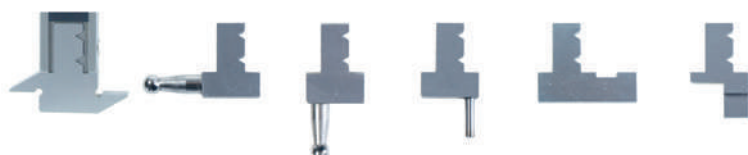

More measuring inserts on page 78



## 1279 Interchangeable inserts made of stainless steel, hardened



1279 780\*

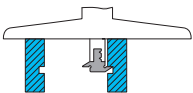
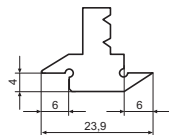

1279 781

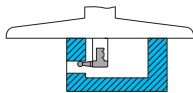
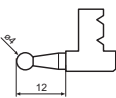

1279 782

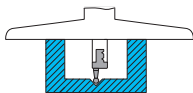

1279 783

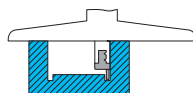

1279 784

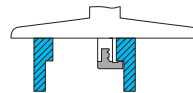

1279 785

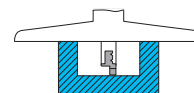
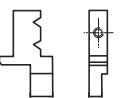

	Description	Order no.	List price EUR
	Insert for width and distance measurements*	1279 780	114.00
	Insert with ball, angled	1279 781	114.00
	Insert with ball, straight	1279 782	114.00
	Insert with measuring pin	1279 783	114.00
	Insert with hook	1279 784	114.00
	Insert with straight measuring rod	1279 785	114.00

\* Standard insert included in the delivery of the basic instrument

## 0279 Sliding measuring base made of stainless steel



### Delivery

- Bolts included

	Dimensions mm	Order no.	List price EUR
	300 x 16	0279 722	272.00
	400 x 16	0279 723	284.00
	500 x 16	0279 724	296.00

### Accessories

	Order no.	List price EUR
Fixture for sliding measuring base, two parts	0279 792	21.50



## 1375 DIGI-MET® Small depth gauge



1



### Model

- Beam made from stainless steel, hardened
- Aluminium body black anodized
- Protection class IP67
- LCD display 7.5 mm
- Factory standard
- Measuring pin Ø 2 mm

### Functions

- ON / OFF
- **Quick-Start**
- **Quick-Lock** (key lock)
- Set to zero at any point
- PRESET-Function (setting a numerical value)
- mm / inch switching
- Variable data output RS 232 + Digimatic + USB

### Delivery

- Wooden case

Icon	Measuring range		Length of beam	Reading		Error limit	Order no.	List price
	mm	inch	mm	mm	inch	mm		EUR
	0 - 25	0 - 1	48	0.01	.0005	0.02	1375 502	249.00



### Accessories

	Order no.	List price
		EUR
Battery, 3V-Lithium, CR 2032	0220 704	3.90
Data cable DATA VARIABLE to RS232	1997 501	50.00
Data cable DATA VARIABLE to digimatic	1998 501	64.00
Data cable DATA VARIABLE to USB	1998 720	72.00





## 1378 DIGI-MET® Depth gauges for one-handed operation



### Model

- Stainless steel
- Inductive measuring system, protection class IP67
- Locking screw
- Factory standard
- Constant measuring force through spring pressure
- Measuring pin with thread M 2.5 for exchangeable measuring inserts for core hole bores, also compatible with dial gauges inserts (see No. 0710) for depth measurement
- Measuring inserts for core hole bores (for additional costs) see table

### Functions

- ON / OFF
- **Quick-Start**
- **Quick-Lock** (key lock)
- Set to zero at any point
- mm / inch switching
- PRESET-Function (setting a numerical value)
- Variable data output RS 232 + Digimatic + USB

### Delivery

- Ball measuring insert for depth measurement

Marked *	Measuring range		Reading		Error limit	Order no.	List price EUR
	mm	inch	mm	inch	mm		
	0 - 60	0 - 2.4	0.01	.0005	0.02	1378 505	788.00
	0 - 100	0 - 4	0.01	.0005	0.02	1378 508	848.00



## 1278 Measuring inserts

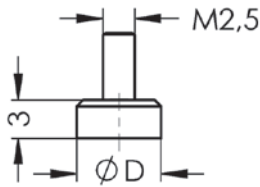

※	☒	Thread size mm	Core diameter mm	Diameter mm	Order no.	List price EUR
		M 16 x 1.5	14.38	14.32	1278 923	28.10
		M 16 x 1.0	14.92	14.87	1278 924	28.10
		M 12 x 1.25	10.65	10.59	1278 936	28.10
		M 12 x 1.0	10.92	10.87	1278 938	28.10
		M 10 x 1.0	8.92	8.87	1278 940	28.10
		M 10 x 0.75	9.19	9.13	1278 942	28.10
		M 8 x 1.0	6.92	6.87	1278 944	28.10
		M 8 x 0.75	7.19	7.14	1278 946	28.10
		M 6 x 0.75	5.19	5.14	1278 948	28.10
		M 5 x 0.5	4.46	4.41	1278 950	28.10
		M 16	13.84	13.79	1278 952	28.10
		M 12	10.11	10.05	1278 954	28.10
		M 10	8.38	8.32	1278 956	28.10
		M 8	6.65	6.59	1278 958	28.10
		M 6	4.92	4.87	1278 960	28.10
		M 5	4.13	4.08	1278 962	28.10
		16 pcs set			1278 930	413.00

1

## 1278 Reduction piece

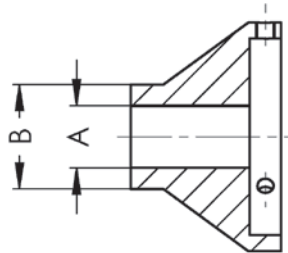

※	☒	A mm	B mm	Order no.	List price EUR
		6	12.00	1278 912	114.00
		9.5	16.00	1278 916	114.00
		15	20.00	1278 920	114.00



## 0273 DIGI-MET® Mounting scales



0273 752



0273 732

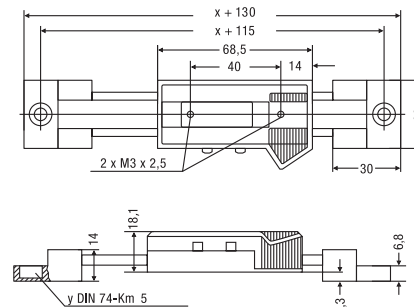
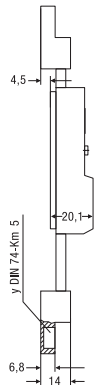
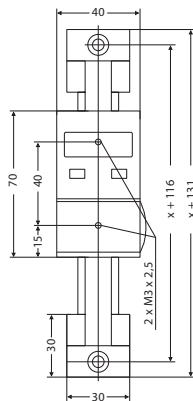

### Model

- Beam made of stainless steel
- Slide and fixture are made of anodized aluminium
- Larger measuring ranges are available upon request
- x = Measuring range
- y = Reduction M5

### Functions

- ON / OFF
- Set to zero at any point
- mm / inch switching
- Hold
- PRESET-Function (setting a numerical value)

### Delivery

- Cardboard box

Measuring range	Measuring range		Reading		Error limit	Order no.	List price EUR
	mm	inch	mm	inch	mm		
<b>Horizontal</b>							
	0 - 150	0 - 6	0.01	.0005	0.03	0273 731	205.00
	0 - 200	0 - 8	0.01	.0005	0.03	0273 732	212.00
	0 - 300	0 - 12	0.01	.0005	0.03	0273 735	229.00
	0 - 450	0 - 18	0.01	.0005	0.03	0273 738	243.00
	0 - 600	0 - 24	0.01	.0005	0.03	0273 741	295.00
	0 - 800	0 - 31	0.01	.0005	0.04	0273 745	516.00
	0 - 1000	0 - 39	0.01	.0005	0.04	0273 746	562.00
<b>Vertical</b>							
	0 - 150	0 - 6	0.01	.0005	0.03	0273 751	368.00
	0 - 200	0 - 8	0.01	.0005	0.03	0273 752	373.00
	0 - 300	0 - 12	0.01	.0005	0.03	0273 755	396.00
	0 - 450	0 - 18	0.01	.0005	0.03	0273 758	417.00
	0 - 600	0 - 24	0.01	.0005	0.03	0273 761	448.00
	0 - 800	0 - 31	0.01	.0005	0.04	0273 765	629.00
	0 - 1000	0 - 39	0.01	.0005	0.04	0273 766	676.00



0996705

0996701

0997770

### Accessories

Accessories	Order no.	List price EUR
Battery, 3V-Lithium, CR 2032	0220 704	3.90
Data cable opto to RS232	0996 701	77.00
Data cable opto to USB	0996 705	147.00
USB-keyboard interface cable	0997 770	251.00



## 0003 Wooden cases for calipers



0003 217



0003 231



0003 248

Measuring range mm	Jaw length (knife points) mm	Jaw length (w.o. knife points) mm	Internal dimensions L x W x H mm	Order no.	List price EUR
<b>With recess for pocket caliper 150 mm</b>					
160	40	40	250 x 90 x 20	0003 217	7.70
<b>With flat foam inlay</b>					
160	40	40	250 x 90 x 20	0003 219	7.70
200	80	80	315 x 145 x 20	0003 220	9.20
250	80	80	370 x 145 x 20	0003 221	11.60
300	90	90	435 x 175 x 20	0003 222	16.00
300		150	435 x 205 x 20	0003 223	17.90
400		125	610 x 180 x 20	0003 224	27.00
400	125	150	590 x 220 x 20	0003 225	35.10
400	150	200	590 x 250 x 20	0003 226	41.90
500		150	690 x 200 x 20	0003 228	46.70
500	150	200	690 x 250 x 25	0003 229	47.90
500	200	250	700 x 315 x 25	0003 230	49.20
500	250		700 x 350 x 21	0003 231	50.00
600		150	790 x 200 x 25	0003 232	50.00
600	150	200	790 x 250 x 25	0003 233	60.00
600		300	810 x 400 x 25	0003 235	73.00
800		150	1000 x 220 x 25	0003 236	61.00
800	150	200	1000 x 270 x 25	0003 237	66.00
800	200		1000 x 320 x 21	0003 238	67.00
800		300	1000 x 380 x 25	0003 239	75.00
800	300		1000 x 420 x 21	0003 240	86.00
800		400	1100 x 480 x 25	0003 241	86.00
1000		150	1200 x 220 x 25	0003 242	82.00
1000	150	200	1250 x 270 x 25	0003 243	88.00
1000	200		1200 x 320 x 21	0003 244	99.00
1000		300	1200 x 380 x 25	0003 245	109.00
1000	300		1230 x 420 x 21	0003 246	118.00
1000		500	1300 x 600 x 25	0003 247	135.00
▪ 1250		200	1520 x 310 x 25	0003 248	115.00
▪ 1250	200	300	1520 x 380 x 25	0003 249	115.00
▪ 1500		200	1800 x 310 x 25	0003 251	152.00
▪ 1500	200	300	1800 x 380 x 25	0003 252	165.00
▪ 1500	300		1800 x 440 x 25	0003 253	196.00
▪ 2000		200	2300 x 310 x 25	0003 254	255.00
▪ 2000	200	300	2300 x 380 x 25	0003 255	301.00
▪ 2000	300		2300 x 460 x 25	0003 256	284.00
▪ 3000		200	3310 x 310 x 25	0003 257	306.00
▪ 3000	200	300	3310 x 400 x 25	0003 258	318.00
▪ 3000	300		3310 x 460 x 25	0003 259	368.00



# SAMPLES MICROMETERS

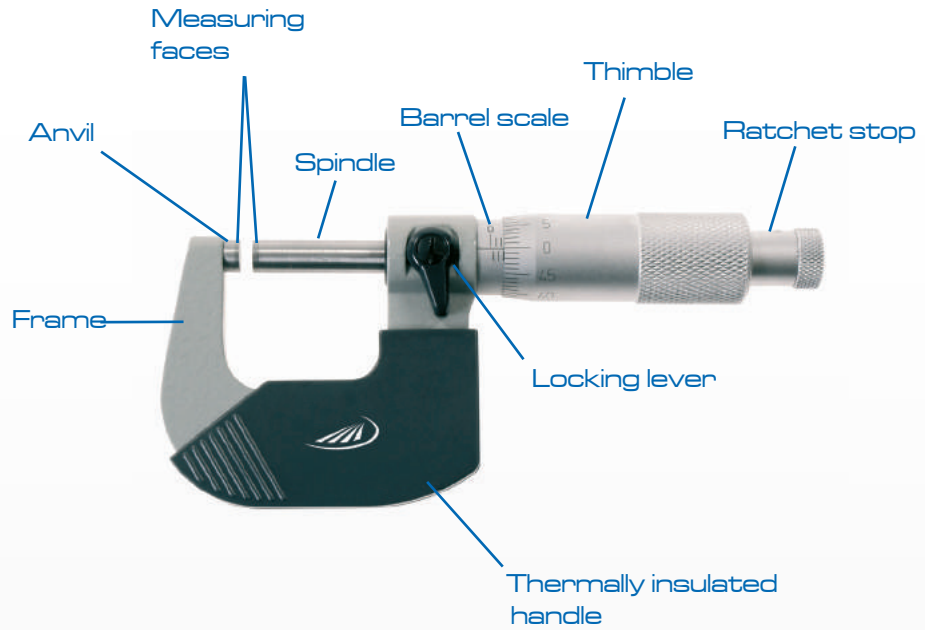

## Micrometer highlights from our assortment



**INTERNAL MICROMETERS**



**SPECIAL MICROMETERS**



**HOLDER & SETTING STANDARDS**

## 2. CHAPTER MICROMETERS

86	External micrometers
93	Digital external micrometers
98	Precision dial micrometers
99	External micrometers with special measuring faces
101	Setting standards for micrometers
102	External micrometers for thread flank measurement
105	External micrometers for gear tooth measurements
106	Wire micrometer
107	Internal micrometers
112	Digital 3 point internal micrometers
114	Digital internal micrometers / with measuring pistol
116	Measuring heads and extensions
117	Depth micrometers



## 0800 External micrometers



0800 501

**DIN  
863-1**

### Model

- DIN 863-1
- Reading: 0.01 mm
- Reading parts are satin chrome finished
- Locking lever
- Ratchet stop
- Carbide measuring faces
- Thermally insulated

### Delivery

- Plastic case
- From measuring range 25 - 50 mm upwards includes a setting standard

✕	⚙	Measuring range mm	Pitch mm	Spindle dia. mm	Thimble dia. mm	Error limit mm	Order no.	List price EUR
		0 - 25	0.5	6.5	17	0.004	0800 501	18.90
		25 - 50	0.5	6.5	17	0.004	0800 502	22.90
		50 - 75	0.5	6.5	17	0.005	0800 503	26.30
		75 - 100	0.5	6.5	17	0.005	0800 504	31.10

## 0800 Set of external micrometers



### Delivery

- Includes 4 external micrometers
- Incl. setting gauges 25/50/75 mm
- Wooden case

**DIN  
863-1**

✕	⚙	Measuring range mm	Pitch mm	Spindle dia. mm	Thimble dia. mm	Order no.	List price EUR
		0 - 100	0.5	6.5	17	0800 513	110.00

## 0807 Holder for external micrometers



### Model

- With heavy cast iron base
- Vertically rotating and lockable

### Delivery

- Cardboard box

✕	⚙	Measuring range mm	Order no.	List price EUR
		0 - 300	0807 101	56.00



## 0806 External micrometers with friction clutch



**DIN**  
**863-1**



0806 501

### Model

- DIN 863-1
- Reading: 0.01 mm
- Reading parts are satin chrome finished
- Locking lever
- With friction clutch (ratchet)
- Fixed quick drive
- Carbide measuring faces
- Thermally insulated

### Delivery

- Plastic case
- From measuring range 25 - 50 mm upwards includes a setting gauge

⌘	⌘	Measuring range mm	Pitch mm	Spindle dia. mm	Thimble dia. mm	Error limit mm	Order no.	List price EUR
		0 - 25	0.5	6.5	18	0.004	0806 501	34.10
		25 - 50	0.5	6.5	18	0.004	0806 502	37.30
		50 - 75	0.5	6.5	18	0.005	0806 503	40.60
		75 - 100	0.5	6.5	18	0.005	0806 504	43.90

2

## 0806 Set of external micrometers with friction clutch



**DIN**  
**863-1**



0806 513

### Delivery

- Includes 4 external micrometers
- Incl. setting gauges 25/50/75 mm
- Wooden case

⌘	⌘	Measuring range mm	Pitch mm	Spindle dia. mm	Thimble dia. mm	Error limit mm	Order no.	List price EUR
		0 - 100	0.5	6.5	18	0.005	0806 513	160.00





## 0806 External micrometers



**DIN**  
**863-1**



### Model

- DIN 863-1
- Reading 0.01 mm
- Reading parts are satin chrome finished
- Locking lever
- Ratchet stop
- Carbide measuring faces
- Thermally insulated
- Coated steel frame

### Delivery

- Plastic case
- From measuring range 25 - 50 mm upwards includes a setting standard

✕	¼	Measuring range mm	Pitch mm	Spindle dia. mm	Thimble dia. mm	Error limit mm	Order no.	List price EUR
		0 - 25	0.5	6.5	17.5	0.004	0806 521	46.00
		25 - 50	0.5	6.5	17.5	0.004	0806 522	74.00
		50 - 75	0.5	6.5	17.5	0.005	0806 523	91.00
		75 - 100	0.5	6.5	17.5	0.005	0806 524	105.00
		100 - 125	0.5	6.5	17.5	0.006	0806 525	143.00
		125 - 150	0.5	6.5	17.5	0.006	0806 526	160.00
		150 - 175	0.5	6.5	17.5	0.007	0806 527	178.00
		175 - 200	0.5	6.5	17.5	0.007	0806 528	196.00

## 0806 Set of external micrometers



**DIN**  
**863-1**



### Delivery

- Includes 4 external micrometers
- Incl. setting gauges 25 + 75 mm or 125 + 175 mm
- Wooden case

✕	¼	Measuring range mm	Pitch mm	Spindle dia. mm	Thimble dia. mm	Order no.	List price EUR
		0 - 100	0.5	6.5	17.5	0806 540	275.00
		100 - 200	0.5	6.5	17.5	0806 542	605.00



## 0810 External micrometers



**DIN**  
**863-1**



0810 504

### Model

- DIN 863-1
- Reading: 0.01 mm
- Reading parts are satin chrome finished
- Locking ring
- Spheroid ductile iron frame, lacquered
- Ratchet stop
- Carbide measuring faces
- Thermally insulated

### Delivery

- Wooden case

2

⌘	⌘	Measuring range mm	Pitch mm	Spindle dia. mm	Thimble dia. mm	Error limit mm	Order no.	List price EUR
		0 - 25	1	8	30	0.004	0810 501	258.00
		25 - 50	1	8	30	0.004	0810 502	273.00
		50 - 75	1	8	30	0.005	0810 503	287.00
		75 - 100	1	8	30	0.005	0810 504	304.00

## 0815 External micrometers with deep frame



**DIN**  
**863-1**



0815 530

### Model

- DIN 863-1
- Reading: 0.01 mm
- Reading parts are satin chrome finished
- Steel bracket lacquered
- Ratchet stop
- Carbide measuring faces
- Wooden case

### Delivery

⌘	⌘	Measuring range mm	Frame depth mm	Pitch mm	Spindle dia. mm	Thimble dia. mm	Error limit mm	Order no.	List price EUR
		0 - 25	100	1	8	24	0.004	0815 510	272.00
		0 - 25	150	1	6.5	24	0.004	0815 514	287.00
		0 - 25	250	1	6.5	24	0.004	0815 518	358.00
		0 - 50	50	1	8	24	0.004	0815 530	308.00
		0 - 50	100	1	8	24	0.004	0815 534	455.00
		50 - 100	100	1	8	24	0.005	0815 540	503.00



## 0816 External micrometers large spindle distance 50 mm



**DIN  
863-1**



### Model

- DIN 863-1
- Direct reading 0.01 mm, without addition because of thread pitch 1 mm
- Reading parts are satin chrome finished
- Locking ring
- Ratchet stop
- Carbide measuring faces
- Thermally insulated
- With 50 mm spindle movement and a wide measuring range
- Spheroid ductile iron frame, lacquered or coated light alloy frame

### Delivery

- Wooden case

✕	⊘	Measuring range mm	Pitch mm	Spindle dia. mm	Thimble dia. mm	Error limit mm	Order no.	List price EUR
		0 - 50	1	8	24	0.004	0816 501	325.00
		50 - 100	1	8	24	0.005	0816 502	367.00
		100 - 150	1	8	24	0.006	0816 503	423.00
		150 - 200	1	8	24	0.007	0816 504	483.00
		200 - 250	1	8	24	0.008	0816 505	550.00
		250 - 300	1	8	24	0.009	0816 506	621.00
		300 - 350	1	10	24	0.01	0816 507	877.00
		350 - 400	1	10	24	0.011	0816 508	926.00
		400 - 450	1	10	24	0.012	0816 509	984.00
		450 - 500	1	10	24	0.013	0816 510	1056.00
		500 - 550	1	10	24	0.015	0816 511	1139.00
		550 - 600	1	10	24	0.017	0816 512	1219.00



## 0817 External micrometers with wide range of applications 100 mm



DIN 863-3

2

### Model

- DIN 863-3
- Direct reading 0.01 mm, without addition because of thread pitch 1 mm
- Reading parts are satin chrome finished

- Spindle adjustment 50 mm
- Reversible anvil (screwed) for measuring range extension
- Locking ring

- Ratchet stop
- Carbide measuring faces
- Thermally insulated
- Robust coated light alloy frame

### Delivery

- Wooden case

»	¼	Measuring range mm	Pitch mm	Spindle dia. mm	Thimble dia. mm	Error limit mm	Order no.	List price EUR
		200 - 300	1	10	24	0.006	0817 512	1047.00
		300 - 400	1	10	24	0.007	0817 514	1089.00
		400 - 500	1	10	24	0.008	0817 516	1219.00
		500 - 600	1	10	24	0.009	0817 518	1383.00
		600 - 700	1	10	24	0.009	0817 520	1547.00
	▪	700 - 800	1	10	24	0.009	0817 522	1716.00
	▪	800 - 900	1	10	24	0.01	0817 524	1889.00
	▪	900 - 1000	1	10	24	0.01	0817 526	2090.00
	▪	1000 - 1100	1	10	24	0.011	0817 528	2302.00
	▪	1100 - 1200	1	10	24	0.011	0817 530	2519.00
	▪	1200 - 1300	1	10	24	0.012	0817 532	2756.00
	▪	1300 - 1400	1	10	24	0.012	0817 534	3054.00
	▪	1400 - 1500	1	10	24	0.013	0817 536	3259.00

## 0817 Replacement reversible anvil



### Model

- Exchangeable for all measuring ranges

»	¼	Length mm	Order no.	List price EUR
		50	0817 910	164.00



## 0819 External micrometers with interchangeable inserts

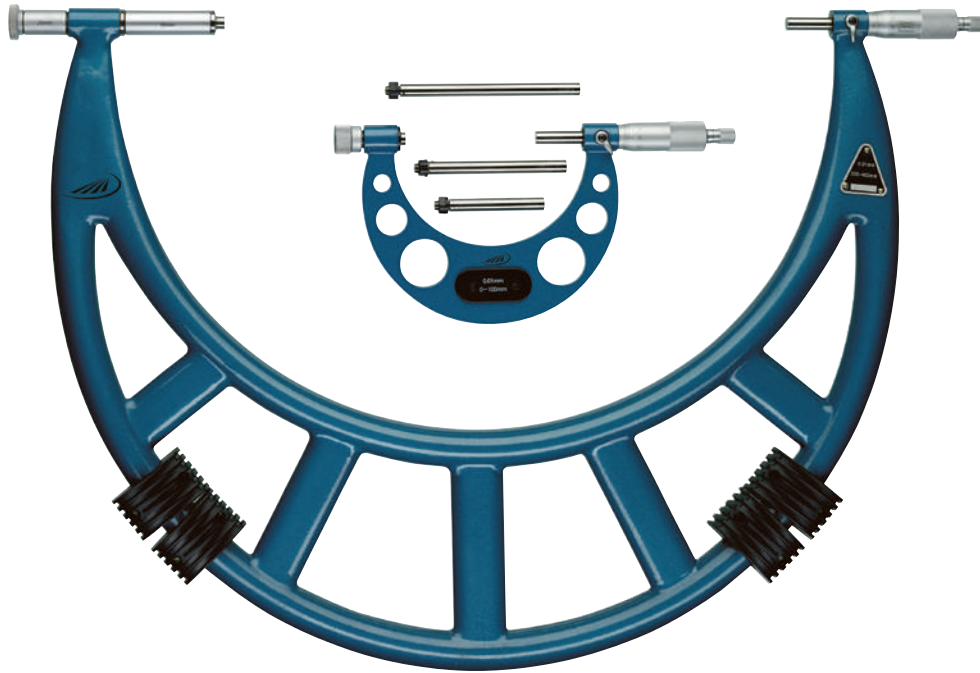

### Model

- Reading: 0.01 mm
- Reading parts are satin chrome finished
- Locking lever
- Ratchet stop
- Carbide measuring faces
- Thermally insulated
- Coated malleable cast iron frame\* or coated light alloy frame with interchangeable anvil

### Delivery

- Wooden case
- Includes setting standards

✕	¼	Measuring range mm	Pitch mm	Spindle dia. mm	Thimble dia. mm	Order no.	List price EUR
		0 - 100	0.5	8	20	0819 501	184.00
		0 - 150	0.5	8	20	0819 502	205.00
		100 - 200	0.5	8	20	0819 503	227.00
		150 - 300	0.5	8	20	0819 505	259.00
		200 - 300	0.5	8	20	0819 510	249.00
		300 - 400	0.5	8	24	0819 511	314.00
		400 - 500	0.5	8	24	0819 512	357.00
		500 - 600	0.5	8	24	0819 513	412.00
		600 - 700	0.5	8	24	0819 514	508.00
	▪	700 - 800	0.5	8	24	0819 515	585.00
	▪	800 - 900	0.5	8	24	0819 516	671.00
	▪	900 - 1000	0.5	8	24	0819 517	758.00
	▪	1000 - 1200	1	8	30	0819 519	1408.00
	▪	1200 - 1400	1	8	30	0819 521	1516.00
	▪	1400 - 1600	1	8	30	0819 523	1786.00
	▪	1600 - 1800	1	8	30	0819 525	2052.00
	▪	1800 - 2000	1	8	30	0819 527	2360.00



## 0912 Digital micrometers



2

### Model

- Protection class IP54
- Reading: 0.0001 mm / .00005 inch
- Locking lever
- Ratchet stop
- Carbide measuring faces
- Thermally insulated
- Factory standard

### Functions

- ON / OFF
- mm / inch switching
- Set to zero at any point

### Delivery

- Plastic case
- From measuring range 25 mm upwards includes a setting standard

Icon	Measuring range		Pitch	Spindle dia.	Error limit	Order no.	List price
	mm	inch					
	0 - 25	0 - 1	0.5	6.5	0.006	0912 501	81.00
	25 - 50	1 - 2	0.5	6.5	0.006	0912 502	92.00
	50 - 75	2 - 3	0.5	6.5	0.007	0912 503	105.00
	75 - 100	3 - 4	0.5	6.5	0.007	0912 504	120.00
	100 - 125	4 - 5	0.5	6.5	0.008	0912 505	132.00
	125 - 150	5 - 6	0.5	6.5	0.008	0912 506	145.00
	150 - 175	6 - 7	0.5	6.5	0.009	0912 507	156.00
	175 - 200	7 - 8	0.5	6.5	0.009	0912 508	168.00

Accessories	Order no.	List price
		EUR
Battery 1.5V, type 357	0220 204	3.30

## 0912 Set of digital micrometers



### Delivery

- Includes 4 micrometers
- Incl. setting gauges 25/50/75 mm
- Wooden case

Icon	Measuring range	Pitch	Spindle dia.	Order no.	List price
	mm	mm	mm		EUR
	0 - 100	0.5	6.5	0912 521	435.00



## 1866 Digital micrometers IP65



1866 410



1866 510



### Model

- Reading: 0.001 mm / .00005 inch
- Protection class IP65
- LCD display: 10 mm
- Rapid drive
- Carbide measuring faces
- Spindle stainless, hardened and smoothed
- Frame lacquered
- Thermally insulated
- Factory standard

### Functions

- ON / OFF
- **Quick-Start**
- **Quick-Lock** (key lock)
- Set to zero at any point
- mm / inch switching
- ABS (display can be set to zero without losing the ORIGIN)
- Hold

### ▪ Additionally 1866 5xx:

- ORIGIN (Preset value)
- Variable data output USB + Digimatic
- TOL (tolerance value input)

### Delivery

- Plastic case
- From measuring range 25 mm upwards includes a setting standard

Measuring range	Measuring range		Pitch	Spindle dia.	Error limit	Order no.	List price
	mm	inch					
<b>Without data output</b>							
	0 - 25	0 - 1	0.5	6.5	0.002	1866 410	207.00
	25 - 50	1 - 2	0.5	6.5	0.002	1866 413	270.00
	50 - 75	2 - 3	0.5	6.5	0.003	1866 417	343.00
	75 - 100	3 - 4	0.5	6.5	0.003	1866 420	391.00
<b>With DataVariable bidirectional</b>							
	0 - 25	0 - 1	0.5	6.5	0.002	1866 510	249.00
	25 - 50	1 - 2	0.5	6.5	0.002	1866 513	299.00
	50 - 75	2 - 3	0.5	6.5	0.003	1866 517	389.00
	75 - 100	3 - 4	0.5	6.5	0.003	1866 520	435.00



1998725

1998802

### Accessories

	Order no.	List price
		EUR
Battery, 3V-Lithium, CR 2032	0220 704	3.90
Data cable bidirectional DataVariable to USB	1998 801	98.00
Data cable bidirectional DataVariable to Digimatic	1998 802	85.00



HELIOS · PREISSER

1866i Digital micrometers IP65 with integrated wireless



1866 41060



**integrated  
IW wireless**  
Wireless Data Transmission

2

**Model**

- Reading: 0.001 mm / .00005 inch
- Protection class IP65
- LCD display: 10 mm
- Rapid drive
- Carbide measuring faces
- Spindle stainless, hardened and smoothed
- Frame lacquered
- Thermally insulated
- Factory standard

**Functions**

- ON / OFF
- **Quick-Start**
- **Quick-Lock** (key lock)
- Set to zero at any point
- mm / inch switching
- ABS (display can be set to zero without losing the ORIGIN)
- Hold
- ORIGIN (Preset value)
- TOL (tolerance value input)
- Integrated Wireless

**Delivery**

- Plastic case
- From measuring range 25 mm upwards includes a setting standard

Measuring range	Measuring range		Pitch	Spindle dia.	Error limit	Order no.	List price
	mm	inch					
0 - 25	0 - 1	0.5	6.5	0.002	1866 41060	259.00	
25 - 50	1 - 2	0.5	6.5	0.002	1866 41360	319.00	
50 - 75	2 - 3	0.5	6.5	0.003	1866 41760	389.00	
75 - 100	3 - 4	0.5	6.5	0.003	1866 42060	435.00	

**Accessories**

	Order no.	List price
		EUR
Battery, 3V-Lithium, CR 2032	0220 704	3.90
i-Stick USB-receiver for Integrated Wireless	1998 780	95.00

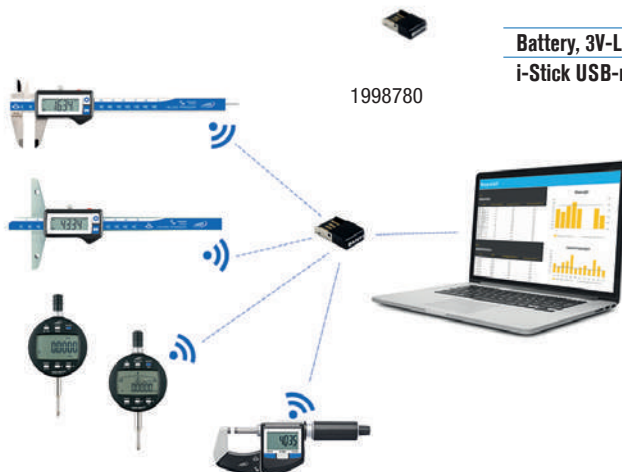

1998780

More information on our i-series and Integrated Wireless on page 277

Integrated Wireless is intended to be sold within the European Economic Area only





## 1866i Digital micrometers IP65 linear 5 mm pitch



**NEW**



### Specification

- Reading: 0,001 mm / .00005 inch
- Protection class IP65
- LCD display: 10 mm
- **Rapid drive**
- Sliding spindle
- Carbide measuring faces
- Spindle stainless, hardened and smoothed
- Frame lacquered
- Thermally insulated
- Factory standard

### Functions

- ON / OFF
- **Quick-Start**
- **Quick-Lock** (key lock)
- Set to zero at any point
- mm / inch switching
- ABS (display can be set to zero without losing the ORIGIN)
- ORIGIN (Preset value)
- Hold
- TOL (tolerance value input)

- Variable data output (1866) USB + Digimatic
- Integrated Wireless (1866i)

### Delivery

- Plastic case
- From measuring range 25 mm upwards includes a setting standard

✕	Measuring range		Pitch mm	Spindle dia. mm	Error limit mm	Order no.	List price EUR
	mm	inch					
<b>With DataVariable bidirectional</b>							
	0 - 25	0 - 1	5	6.5	0.002	1866 610	339.00
	25 - 50	1 - 2	5	6.5	0.002	1866 613	389.00
	50 - 75	2 - 3	5	6.5	0.003	1866 617	489.00
	75 - 100	3 - 4	5	6.5	0.003	1866 620	529.00
<b>With Integrated Wireless</b>							
	0 - 25	0 - 1	5	6.5	0.002	186661 060	349.00
	25 - 50	1 - 2	5	6.5	0.002	186661 360	399.00
	50 - 75	2 - 3	5	6.5	0.003	186661 760	499.00
	75 - 100	3 - 4	5	6.5	0.003	186662 060	539.00

Integrated Wireless is intended to be sold within the European Economic Area only

### Accessories



	Order no.	List price EUR
Battery, 3V-Lithium, CR 2032	0220 704	3.90
Data cable bidirectional DataVariable to USB	1998 801	98.00
Data cable bidirectional DataVariable to Digimatic	1998 802	85.00
i-Stick USB-receiver for Integrated Wireless	1998 780	95.00



## 1866 Digital micrometer BASIC



### Model

- Reading: 0.001 mm / .00005 inch
- Protection class IP40
- LCD display: 10 mm
- Rapid drive
- Carbide measuring faces
- Spindle stainless, hardened and smoothed
- Frame lacquered
- Thermally insulated
- Factory standard

### Functions

- ON / OFF
- **Quick-Start**
- **Quick-Lock** (key lock)
- Set to zero at any point
- mm / inch switching
- Hold

### Delivery

- Plastic case

Icon	Measuring range		Pitch mm	Spindle dia. mm	Error limit mm	Order no.	List price EUR
	mm	inch					
	0 - 25	0 - 1	0.5	6.5	0.002	1866 210	175.00

### Accessories

Battery, 3V-Lithium, CR 2032

### Order no.

0220 704

### List price

EUR  
3.90

## 1866i Sets of digital micrometers



Icon	Measuring range		Spindle dia. mm	Order no.	List price EUR
	mm	inch			
<b>With Integrated Wireless</b>					
	0 - 100	0 - 4	6.5	1866 42160	1390.00
<b>With DataVariable bidirectional</b>					
	0 - 100	0 - 4	6.5	1866 521	1360.00

### Delivery

- Plastic case
- from measuring range 25 mm upwards includes a setting standard

### Accessories

Battery, 3V-Lithium, CR 2032

Data cable bidirectional DataVariable to USB

Data cable bidirectional DataVariable to Digimatic

i-Stick USB-receiver for Integrated Wireless

### Order no.

0220 704

1998 801

1998 802

1998 780

### List price

EUR

3.90

98.00

85.00

95.00



## 0849 Precision dial micrometers



DIN  
863-3



0849 501

### Model

- DIN 863-3
- Reading: 0.01 mm
- Reading on the dial: 1  $\mu$ m
- Reading parts are satin chrome finished
- Retraction stroke 1.5 mm

- Spindle made of hardened stainless steel
- Constant measuring force
- Locking lever
- Carbide measuring faces
- Thermally insulated

### Delivery

- Wooden case

$\nabla$	$\frac{1}{2}$	Measuring range mm	Pitch mm	Spindle dia. mm	Thimble dia. mm	Order no.	List price EUR
		0 - 25	0.5	7.5	17.5	0849 501	737.00
		25 - 50	0.5	7.5	17.5	0849 502	876.00

## 0850 Precision dial micrometers



DIN  
863-3

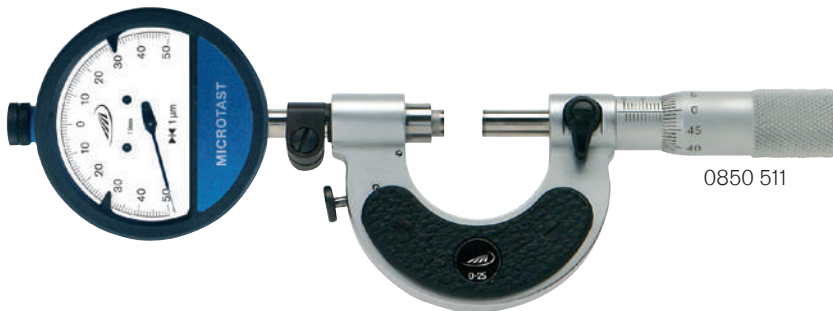

0850 511

### Model

- DIN 863-3
- Reading: 0.01 mm
- Reading on the dial: 1  $\mu$ m
- Reading parts are satin chrome finished
- Retraction stroke 1.2 mm

- Locking lever
- Carbide measuring faces
- Constant measuring force
- Thermally insulated
- Spindle made of hardened stainless steel

- Adjustable tolerance markers

### Delivery

- Wooden case
- Incl. dial comparator gauge

$\nabla$	$\frac{1}{2}$	Measuring range mm	Pitch mm	Spindle dia. mm	Thimble dia. mm	Order no.	List price EUR
		0 - 25	0.5	7.5	17.5	0850 511	582.00
		25 - 50	0.5	7.5	17.5	0850 512	646.00
		50 - 100	0.5	7.5	17.5	0850 514	687.00
		100 - 150	0.5	7.5	17.5	0850 516	734.00
		150 - 200	0.5	7.5	17.5	0850 518	768.00



## 0822 Disc micrometers



### Model

- Factory standard
- Reading: 0.01 mm
- Carbide measuring faces
- Ratchet stop
- Disc dia. 60 mm
- Malleable cast iron frame, lacquered

### Delivery

- Wooden case

Measuring range mm	Pitch mm	Spindle dia. mm	Thimble dia. mm	Order no.	List price EUR
<b>Frame depth 50 mm</b>					
0 - 15	1	6.5	20	0822 301	95.00
0 - 25	1	6.5	20	0822 302	144.00
0 - 50	1	6.5	20	0822 303	265.00
<b>Frame depth 100 mm</b>					
0 - 50	1	6.5	20	0822 304	433.00

## 0824 Micrometers for tube wall measurement



**DIN**  
**863-3**

### Model

- DIN 863-3
- Reading: 0.01 mm
- Reading parts are satin chrome finished
- Ratchet stop
- Hardened measuring faces

- Malleable cast iron frame, lacquered

### Delivery

- Cardboard box

Measuring range mm	Pitch mm	Spindle dia. mm	Thimble dia. mm	Error limit mm	Order no.	List price EUR
<b>Ball dia. 2.5 mm</b>						
0 - 15	0.5	6.5	20	0.001	0824 302	181.00
<b>Ball dia. 6.5 mm</b>						
0 - 25	0.5	6.5	20	0.001	0824 303	183.00



## 0854 Blade micrometers



**DIN**  
**863-3**



### Model

- DIN 863-3
- Reading: 0.01 mm
- Reading parts are satin chrome finished
- Ratchet stop
- Thermally insulated
- Hardened spindle and anvil
- Coated steel frame

### Delivery

- Plastic case
- From measuring range 25 - 50 mm upwards includes a setting standard

✕	¼	Measuring range mm	Pitch mm	Spindle dia. mm	Thimble dia. mm	Error limit mm	Order no.	List price EUR
<b>Measuring faces dia. 0.8 x 7 mm</b>								
		0 - 25	0.5	8	17.5	0.004	0854 301	257.00
		25 - 50	0.5	8	17.5	0.004	0854 302	312.00
		50 - 75	0.5	8	17.5	0.005	0854 303	334.00
		75 - 100	0.5	8	17.5	0.005	0854 304	363.00

## 0855 Micrometers with reduced measuring faces



**DIN**  
**863-3**



### Model

- DIN 863-3
- Reading: 0.01 mm
- Reading parts are satin chrome finished
- Locking lever
- Ratchet stop
- Carbide measuring faces
- Thermally insulated
- Hardened spindle and anvil
- Coated steel frame

### Delivery

- Plastic case
- From measuring range 25 - 50 mm upwards includes a setting standard

✕	¼	Measuring range mm	Pitch mm	Spindle dia. mm	Thimble dia. mm	Error limit mm	Order no.	List price EUR
<b>Measuring surfaces dia. 3 mm, length 8.5 mm</b>								
		0 - 25	0.5	6.5	17.5	0.004	0855 301	185.00
		25 - 50	0.5	6.5	17.5	0.004	0855 302	227.00
		50 - 75	0.5	6.5	17.5	0.005	0855 303	257.00
		75 - 100	0.5	6.5	17.5	0.005	0855 304	272.00



## 0898 Settings gauges for micrometers



0898 104

### Model

- Rod
- Special steel, aged
- Hardened measuring faces
- Tolerance zone js2
- Thermally insulated
- Parallel lapped measuring faces

⊗	⊗	Measuring range mm	Measuring surface dia. mm	Order no.	List price EUR
		25	6.5	0898 101	11.40
		50	6.5	0898 102	19.10
		75	6.5	0898 103	22.60
		100	6.5	0898 104	25.80
		125	6.5	0898 105	29.90
		150	6.5	0898 106	42.30
		175	6.5	0898 107	47.30
		200	6.5	0898 108	52.00
		225	6.5	0898 109	57.00
		250	6.5	0898 110	63.00
		275	6.5	0898 111	67.00
		300	10	0898 112	83.00
		325	10	0898 113	90.00
		350	10	0898 114	96.00
		375	10	0898 115	102.00
		400	10	0898 116	109.00
		425	10	0898 117	116.00
		450	10	0898 118	122.00
		475	10	0898 119	128.00
		500	10	0898 120	135.00
		525	10	0898 121	142.00
		550	10	0898 122	149.00
		575	10	0898 123	156.00
		600	10	0898 124	164.00
		625	10	0898 125	171.00
		650	10	0898 126	177.00

⊗	⊗	Measuring range mm	Measuring surface dia. mm	Order no.	List price EUR
		675	10	0898 127	184.00
		700	10	0898 128	192.00
		725	10	0898 129	199.00
		750	10	0898 130	206.00
		775	10	0898 131	214.00
		800	10	0898 132	221.00
		825	10	0898 133	226.00
		850	10	0898 134	233.00
		875	10	0898 135	242.00
		900	10	0898 136	249.00
		925	10	0898 137	255.00
		950	10	0898 138	263.00
		975	10	0898 139	271.00
		1000	10	0898 140	277.00
	▪	1050	10	0898 142	290.00
	▪	1150	10	0898 146	318.00
	▪	1250	10	0898 150	349.00
	▪	1350	10	0898 154	376.00
	▪	1450	10	0898 158	405.00
	▪	1550	10	0898 162	649.00
	▪	1650	10	0898 166	681.00
	▪	1750	10	0898 170	713.00
	▪	1850	10	0898 174	744.00
	▪	1950	10	0898 178	774.00



## 0870 Precision micrometers for thread flank measurement



**DIN  
863-3**

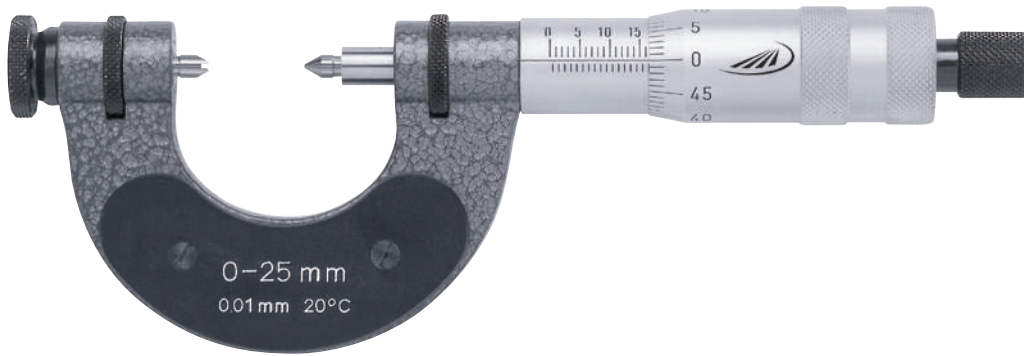

### Model

- DIN 863-3
- Reading 0.01 mm
- Reading parts are satin chrome finished
- Locking ring
- Ratchet stop
- Thermally insulated
- Spheroid ductile iron frame, lacquered

### Delivery

- Wooden case
- **Thread flank inserts and setting standards must be ordered separately**

✕	📏	Measuring range	Pitch	Thimble dia.	Error limit	Spindle adjustment	Required length of setting standard	Order no.	List price
		mm	mm	mm	mm	mm	mm		EUR
<b>For inserts with shank dimensions, dia. 3.5 x 13.5 mm</b>									
		0 - 25	0.5	20	0.004	25	-	0870 301	307.00
		25 - 50	0.5	20	0.004	25	25	0870 302	321.00
		50 - 75	0.5	20	0.005	25	50	0870 303	345.00
		75 - 100	0.5	20	0.005	25	75	0870 304	377.00
		100 - 125	0.5	20	0.006	25	100	0870 305	413.00
		125 - 150	0.5	20	0.006	25	125	0870 306	449.00
		150 - 200	0.5	20	0.007	50	175	0870 307	640.00
		200 - 250	0.5	20	0.008	50	225	0870 309	699.00
		250 - 300	0.5	20	0.009	50	275	0870 311	769.00



## 0870 Thread flank inserts for external measurement

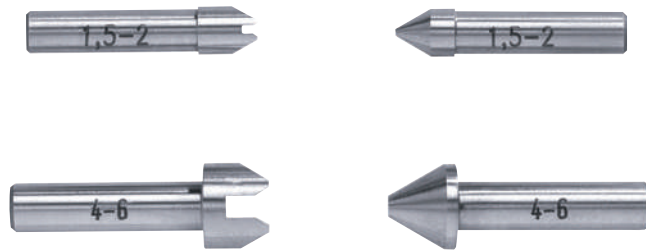

### Model

- Made of hardened special steel and finely grinded
- Every insert is inscribed with the pitch details
- In a set (V-anvil + tapered anvil)
- Shank dimensions: 3.5 x 13.5 mm

Icon	Pitch angle in degrees	Pitch mm	Applicable for UNC, UNF 60°	Thread pitch in TPI mm	Order no.	List price EUR
<b>Metric ISO - threads</b>						
	60°	0.35 - 0.50	72 - 48		0870 901	116.00
	60°	0.60 - 0.80	44 - 32		0870 903	100.00
	60°	0.90 - 1.25	28 - 18		0870 905	100.00
	60°	1.5 - 2.0	16 - 11		0870 907	100.00
	60°	2.5 - 3.5	10 - 7		0870 909	100.00
	60°	4.0 - 6.0	6 - 4		0870 911	116.00
<b>Whitworth - threads</b>						
	55°			60 - 48	0870 921	126.00
	55°			40 - 32	0870 923	109.00
	55°			28 - 22	0870 925	109.00
	55°			20 - 16	0870 927	109.00
	55°			14 - 11	0870 929	109.00
	55°			10 - 7	0870 931	109.00
	55°			6 - 4	0870 933	126.00
<b>Metric ISO - Trapezoid threads (DIN 103)</b>						
	30°	1.5			0870 941	297.00
	30°	2.0			0870 943	216.00
	30°	3.0			0870 945	190.00
	30°	4.0			0870 947	190.00
	30°	5.0 - 6.0			0870 949	190.00
	30°	7.0 - 8.0			0870 951	190.00
	30°	9.0 - 10.0			0870 953	216.00
	30°	12.0 - 14.0			0870 955	297.00







## 0870 Thread flank setting gauges for external measurement



### Model

- Measuring faces made of hardened special steel
- One end is rounded, the lapped bore simplifies the fitting upon the conical insert
- Thermally insulated handle
- **Note: With trapezoid treads every pitch requires a separate setting standard**

 	Length mm	Pitch angle in degrees	Available for following pitches mm	Error limit µm	Order no.	List price EUR
<b>Metric ISO - threads</b>						
	25	60°		3	0870 801	73.00
	50	60°		3	0870 802	74.00
	75	60°		3	0870 803	75.00
	100	60°		4	0870 804	76.00
	125	60°		4	0870 805	77.00
	175	60°		4	0870 807	85.00
	225	60°		4	0870 809	96.00
	275	60°		4	0870 811	106.00
<b>Whitworth - threads</b>						
	25	55°		3	0870 821	73.00
	50	55°		3	0870 822	74.00
	75	55°		3	0870 823	75.00
	100	55°		4	0870 824	80.00
	125	55°		4	0870 825	81.00
	175	55°		4	0870 827	93.00
	225	55°		4	0870 829	107.00
	275	55°		4	0870 831	122.00
<b>Metric ISO - Trapezoid threads (DIN 103)*</b>						
	25	30°	2 / 3 / 4 / 5 - 6 / 7 - 8 / 9 - 10	4	0870 841	159.00
	50	30°	2 / 3 / 4 / 5 - 6 / 7 - 8 / 9 - 10	4	0870 842	164.00
	75	30°	2 / 3 / 4 / 5 - 6 / 7 - 8 / 9 - 10	4	0870 843	168.00
	100	30°	3 / 4 / 5 - 6 / 7 - 8 / 9 - 10 / 12 - 14	5	0870 844	175.00
	125	30°	4 / 5 - 6 / 7 - 8 / 9 - 10 / 12 - 14	5	0870 845	190.00
	175	30°	4 / 5 - 6 / 7 - 8 / 9 - 10 / 12 - 14	5	0870 847	226.00
	225	30°	5 - 6 / 7 - 8 / 9 - 10 / 12 - 14	5	0870 849	276.00
	275	30°	5 - 6 / 7 - 8 / 9 - 10 / 12 - 14	5	0870 851	338.00

\* When ordering the respective pitch must be specified



## 0864 Disc micrometers to measure gear tooth

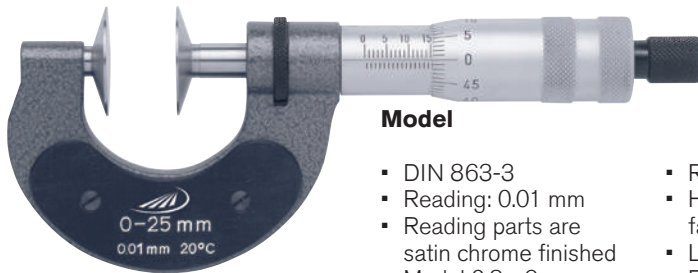

DIN 863-3

### Model

- DIN 863-3
- Reading: 0.01 mm
- Reading parts are satin chrome finished
- Modul 0.8 - 6
- Ratchet stop
- Hardened measuring faces
- Locking ring
- Friction coupling
- Thermally insulated

### Delivery

- Wooden case

⌘	⌘	Measuring range mm	Disc dia. mm	Pitch mm	Thimble dia. mm	Error limit mm	Order no.	List price EUR
		0 - 25	25	0.5	20	0.004	0864 321	330.00
		25 - 50	25	0.5	20	0.004	0864 322	396.00
		50 - 75	25	0.5	20	0.005	0864 323	429.00
		75 - 100	25	0.5	20	0.005	0864 324	466.00
		100 - 125	25	0.5	20	0.006	0864 325	503.00
		125 - 150	25	0.5	20	0.006	0864 326	539.00
		150 - 175	25	0.5	20	0.007	0864 327	579.00
		175 - 200	25	0.5	20	0.007	0864 328	619.00

## 0890 Wire thickness micrometer



### Model

- Factory standard
- Reading: 0.01 mm
- Readings parts are satin chrome finished
- Ratchet stop
- Carbide measuring faces

### Delivery

- Cardboard box

⌘	⌘	Measuring range mm	Pitch mm	Spindle dia. mm	Thimble dia. mm	Order no.	List price EUR
		0 - 10	0.5	6	18	0890 511	69.00



## 0884 Internal micrometer with measuring jaws

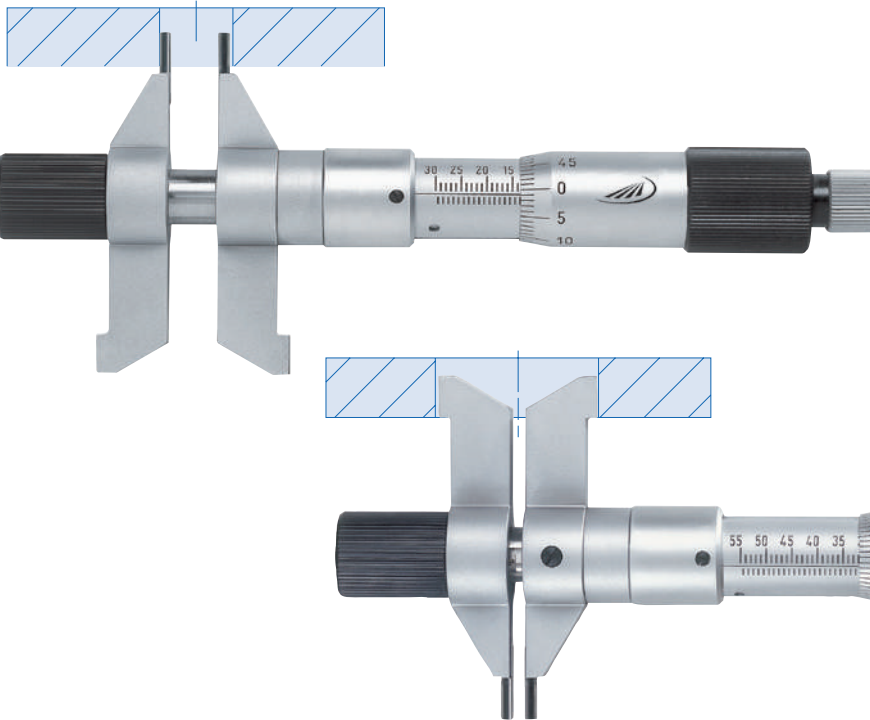

### Model

**DIN**  
**863-4**

- DIN 863-4
- Reading: 0.01 mm
- Reading parts are satin chrome finished
- Forward friction coupling
- Cylindrical carbide tipped measuring faces
- Measuring jaws on both sides (measuring ranges 5-30 mm, 30-55 mm)
- Divisions on both sides

### Delivery

- Wooden case

✂	¼	Measuring range mm	Thimble dia. mm	Pitch mm	Error limit µm	Order no.	List price EUR
		5 - 55	20	0.5	2.5	0884 501	827.00

## 0885 Internal micrometers with measuring jaws



0885 502

### Model

- Factory standard
- Reading: 0.01 mm
- Reading parts and body are satin chrome finished
- Ratchet stop
- Carbide measuring faces
- Cylindrical carbide tipped measuring faces

### Delivery

- Plastic case

✂	¼	Measuring range mm	Thimble dia. mm	Pitch mm	Order no.	List price EUR
		5 - 30	17	0.5	0885 501*	183.00
		25 - 50	17	0.5	0885 502	203.00
		50 - 75	17	0.5	0885 503	213.00
		75 - 100	17	0.5	0885 504	255.00
		100 - 125	17	0.5	0885 505	324.00
		125 - 150	17	0.5	0885 506	374.00
		150 - 175	17	0.5	0885 507	476.00
		175 - 200	17	0.5	0885 508	540.00



## 0888 Internal micrometers cylindrical version

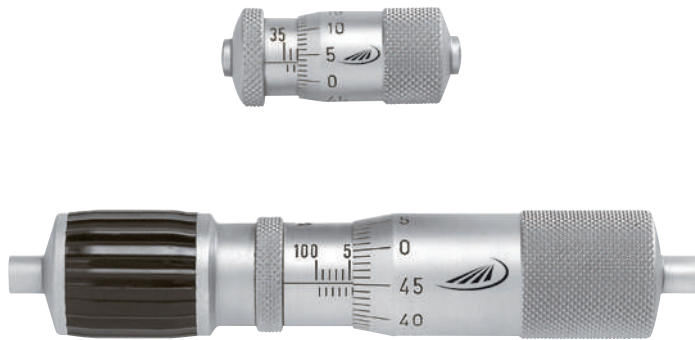

### Model

- DIN 863-4
- Reading: 0.01 mm
- Reading parts are satin chrome finished
- Carbide measuring faces dia. 6 mm, spherical lapped
- From measuring range 100 - 125 mm with thermal insulation

**DIN**  
**863-4**

- From measuring range 100 - 125 mm with locking ring

### Delivery

- Wooden case

⌂	⌂	Measuring range mm	Thimble dia. mm	Pitch mm	Error limit µm	Order no.	List price EUR
		25 - 30	15	0.5	4	0888 501	160.00
		30 - 35	15	0.5	4	0888 502	160.00
		35 - 50	15	0.5	4	0888 503	160.00
		50 - 75	16	0.5	5	0888 504	167.00
		75 - 100	17	0.5	5	0888 505	173.00
		100 - 125	20	0.5	6	0888 506	193.00
		125 - 150	20	0.5	6	0888 507	198.00
		150 - 175	20	0.5	7	0888 508	205.00
		175 - 200	20	0.5	7	0888 509	213.00
		200 - 225	20	0.5	8	0888 510	219.00
		225 - 250	20	0.5	8	0888 511	225.00
		250 - 275	20	0.5	9	0888 512	233.00
		275 - 300	20	0.5	9	0888 513	242.00
		300 - 325	20	0.5	10	0888 514	251.00
		325 - 350	20	0.5	10	0888 515	257.00
		350 - 375	20	0.5	11	0888 516	268.00
		375 - 400	20	0.5	11	0888 517	274.00
		400 - 425	20	0.5	12	0888 518	284.00
		425 - 450	20	0.5	12	0888 519	293.00
		450 - 475	20	0.5	13	0888 520	300.00
		475 - 500	20	0.5	13	0888 521	307.00

## 0888 Holder for internal micrometers

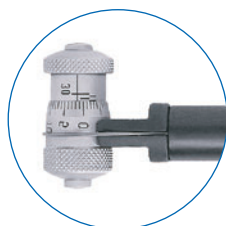

### Model

- Ideal for all internal micrometers from series 0888 / 0892
- Length 200 mm

⌂	⌂	Order no.	List price EUR
		0888 101	51.00



## 0892 Internal micrometers with interchangeable extensions



**DIN**  
**863-4**



0892 501

### Model

- DIN 863-4
- Reading: 0.01 mm
- Reading parts are satin chrome finished

### Delivery

- Threaded extension rods with thermally insulated handle
- Carbide measuring faces, spherical lapped
- Wooden case

✂	☞	Measuring range	Thimble dia.	Pitch	Extensions	Error limit	Order no.	List price
		mm	mm	mm		µm		EUR
		50 - 150	17	0.5	25 / 50	6	0892 501	392.00
		50 - 250	17	0.5	25 / 50 / 100	8	0892 502	480.00
		50 - 450	17	0.5	25 / 50 / 100 / 200	10	0892 503	592.00
		50 - 850	17	0.5	25 / 50 / 100 / 200 / 400	12	0892 504	746.00
		50 - 1450	17	0.5	25 / 50 / 100 / 200 / 400 / 600	15	0892 505	947.00

## 0892 Extensions for internal micrometers



0892 334

✂	☞	Length mm	Order no.	List price EUR
		25	0892 332	74.00
		50	0892 333	75.00
		100	0892 334	83.00
		200	0892 336	102.00
		400	0892 339	135.00
		600	0892 340	190.00



## 0894 Precision internal micrometers with extensions

**DIN  
863-4**



### Model

- DIN 863-4
- Measuring ends: dia. 7 mm x 6 mm long, carbide tipped spherical lapped
- Thread pitch 1 mm
- Internal spring mounted rods with thermal protective sleeves

- Extensions greater than 100 mm: external steel tube dia. 17 mm, with thermal insulation
- Extensions 500 and 1000 mm: strengthened specification - steel tube dia. 32 mm

- Basic internal micrometer is adjustable: 50 mm. The spindle is tight, so that during measurement the thimble does not adjust itself.

### Delivery

- Wooden case

✕	⊘	Measuring range mm	Length of extensions mm (tube dia. 17 mm)	Length of extensions mm (tube dia. 32 mm)	Error limit μm	Order no.	List price EUR
		100 - 150	only micrometer, excludes case	-	4	0894 504	233.00
		100 - 300	50 / 100	-	7	0894 510	620.00
		100 - 500	50 / 100 / 200	-	9	0894 514	836.00
		100 - 900	50 / 100 / 200 / 400	-	11	0894 518	1080.00
		100 - 1300	50 / 100 / 200 / 400 / 400	-	13	0894 522	1330.00
		100 - 1700	50 / 100 / 200 / 400 / 800	-	15	0894 526	1368.00
		100 - 2100	50 / 100 / 200 / 400 / 400 / 800	-	18	0894 530	1605.00
		100 - 2500	50 / 100 / 200 / 400 / 800 / 800	-	21	0894 534	1648.00
		100 - 2000	50 / 100 / 200 / 200	500 / 1 x 1000	18	0894 538	2877.00
		100 - 3000	50 / 100 / 200 / 200	500 / 2 x 1000	30	0894 542	3752.00
		100 - 4000	50 / 100 / 200 / 200	500 / 3 x 1000	40	0894 546	4658.00
	▪	100 - 5000	50 / 100 / 200 / 200	500 / 4 x 1000	50	0894 550	5534.00
	▪	100 - 6000	50 / 100 / 200 / 200	500 / 5 x 1000	60	0894 554	6410.00

With the larger measuring ranges we recommend that the ends of the precision internal micrometer to be placed and/or held on 2 points with an approximate distance of 22% of the measuring length, thus minimizing deflection. The error indicated in the table above refers to the maximum deflection of the appropriate set. When smaller dimensions are measured, the error is smaller and corresponds to the error value of the smaller sets.

## 0894 Individual extensions



✕	⊘	Length mm	Tube dia. mm	Order no.	List price EUR
		50	17	0894 804	167.00
		100	17	0894 806	190.00
		200	17	0894 810	205.00
		400	17	0894 820	226.00
		800	17	0894 834	257.00
		500	32	0894 854	845.00
		1000	32	0894 872	877.00



## 1921 3 point internal micrometers



**DIN  
863-4**



1921 512



1921 534

### Model

- DIN 863-4
- Reading: 0.001 mm\*
- Reading: 0.005 mm
- Reading parts are satin chrome finished
- Pitch 0.5 mm
- Carbide tipped measuring pins from measuring range 12 mm

### Delivery

- Plastic case
- Incl. setting ring
- Calibration certificate for ring and micrometer



**Inclusive!**

✕	☒	Measuring range mm	Measuring depth mm	Thimble dia. mm	Error limit µm	Order no.	List price EUR
▪		6 - 8	58	16	4	1921 510*	398.00
▪		8 - 10	58	16	4	1921 512*	398.00
▪		10 - 12	58	16	4	1921 514*	398.00
▪		12 - 16	64	16	4	1921 516*	398.00
▪		16 - 20	64	16	4	1921 518*	422.00
▪		20 - 25	68	25	4	1921 520	433.00
▪		25 - 30	68	25	4	1921 522	439.00
▪		30 - 40	76	25	4	1921 524	493.00
▪		40 - 50	76	25	4	1921 526	493.00
▪		50 - 60	79	25	5	1921 528	568.00
▪		60 - 70	79	25	5	1921 530	585.00
▪		70 - 85	97	25	5	1921 532	601.00
▪		85 - 100	97	25	5	1921 534	617.00
▪		100 - 125	132	25	6	1921 536	866.00
▪		125 - 150	132	25	6	1921 538	1023.00
▪		150 - 175	132	25	7	1921 540	1077.00
▪		175 - 200	132	25	7	1921 542	1137.00



## 1920 Set of 3 point internal micrometers



**DIN  
863-4**



### Model

- DIN 863-4
- Reading: 0.001 mm\*
- Reading: 0.005 mm
- Reading parts are satin chrome finished
- Pitch 0.5 mm
- Carbide tipped measuring pins from measuring range 12 mm
- Ratchet stop
- From measuring range 12 mm for through and blind holes

### Delivery

- Plastic case
- Incl. setting ring
- Calibration certificate for ring and micrometer

2

⌘	⚙	Measuring range mm	Thimble dia. mm	Number of devices	Order no.	List price EUR
▪		6 - 12	16	3	1920 574	1126.00
▪		12 - 20	16	2	1920 576	790.00
▪		20 - 50	25	4	1920 578	1949.00
▪		50 - 100	25	4	1920 580	2328.00

## 1920 Measuring depth extensions for 3 point internal micrometers



### Model

- Suitable for devices 1920, 1921, 1923 and 1924



⌘	⚙	Measuring range mm	Length mm	Order no.	List price EUR
		6 - 12	75	1920 910	92.00
		12 - 20	75	1920 914	98.00
		20 - 30	100	1920 920	103.00
		30 - 200	100	1920 924	124.00





## 1923 DIGI-MET® 3 point internal micrometers



### Model

- DIN 863-4
- Reading: 0.001 mm / .00005 inch
- Protection class IP52
- LCD display 8.5 mm
- Ratchet stop
- For through holes
- From measuring range 12 mm for through and blind holes
- From measuring range 12 mm with carbide tipped measuring faces

### Functions

- ON / OFF
- Set to zero at any point
- mm / inch switching
- ABS (display can be set to zero without losing the Preset value)
- **Quick-Lock** (key lock)
- PRESET-Function (setting a numerical value)
- Variable data output RS 232 + Digimatic + USB

### Delivery

- Plastic case
- Incl. setting ring
- Calibration certificate for setting ring and micrometer



**Inclusive!**

✕	☒	Measuring range mm	Measuring depth mm	Error limit µm	Order no.	List price EUR
▪		6 - 8	58	4	1923 510	1099.00
▪		8 - 10	58	4	1923 512	1099.00
▪		10 - 12	58	4	1923 514	1110.00
▪		12 - 16	64	4	1923 516	1110.00
▪		16 - 20	64	4	1923 518	1157.00
▪		20 - 25	68	4	1923 520	1177.00
▪		25 - 30	68	4	1923 522	1188.00
▪		30 - 40	76	4	1923 524	1240.00
▪		40 - 50	76	4	1923 526	1245.00
▪		50 - 60	79	5	1923 528	1339.00
▪		60 - 70	79	5	1923 530	1370.00
▪		70 - 85	97	5	1923 532	1401.00
▪		85 - 100	97	5	1923 534	1454.00
▪		100 - 125	132	6	1923 536	1766.00
▪		125 - 150	132	6	1923 538	1975.00
▪		150 - 175	132	7	1923 540	2126.00
▪		175 - 200	132	7	1923 542	2308.00



1998720



1998501



1997501

### Accessories

	Order no.	List price EUR
Battery, 3V-Lithium, CR 2032	0220 704	3.90
Data cable DATA VARIABLE to RS232	1997 501	50.00
Data cable DATA VARIABLE to digimatic	1998 501	64.00
Data cable DATA VARIABLE to USB	1998 720	72.00



## 1923 DIGI-MET® Set of 3 point internal micrometers



### Delivery

- Plastic case
- Incl. setting ring
- Calibration certificate for setting ring and micrometer



Measuring range	Error limit	Number of devices	Order no.	List price
				EUR
6 - 12	4	3	1923 574	1771.00
12 - 20	4	2	1923 576	1563.00
20 - 50	4	4	1923 578	2292.00
50 - 100	5	4	1923 580	2813.00



### Accessories

	Order no.	List price
Battery, 3V-Lithium, CR 2032	0220 704	3.90
Data cable DATA VARIABLE to RS232	1997 501	50.00
Data cable DATA VARIABLE to digimatic	1998 501	64.00
Data cable DATA VARIABLE to USB	1998 720	72.00

## 1923 DIGI-MET® Basic unit for 3 point internal micrometers



### Model

- Reading: 0.001 mm / .00005 inch
- Protection class IP52
- LCD display 8,5 mm
- Ratchet stop
- Mounting thread for changing of measuring heads

### Functions

- ON / OFF
- Set to zero at any point
- mm / inch switching
- ABS (display can be set to zero without losing the Preset value)
- Quick-Lock (key lock)
- PRESET-Function (setting a numerical value)
- Variable data output RS 232 + Digimatic + USB

Measuring range	Order no.	List price
6 - 20	1923 100	797.00
20 - 100	1923 200	797.00
100 - 200	1923 300	797.00

Single measuring heads on page 116



## 1924 DIGI-MET® 3 point internal measuring pistols



### Model

- For through holes
- Mounting thread for changing of measuring heads
- From measuring range 12 mm for through and blind holes
- From measuring range 12 mm with carbide tipped measuring faces
- Digital indicator recommended as display device

### Delivery

- Plastic case
- Incl. setting ring
- Without display device
- Calibration certificate  
**for setting ring included**



**Inclusive!**

⌘	⚙	Measuring range mm	Measuring depth mm	Order no.	List price EUR
▪		6 - 8	58	1924 510	818.00
▪		8 - 10	58	1924 512	818.00
▪		10 - 12	58	1924 514	828.00
▪		12 - 16	64	1924 516	839.00
▪		16 - 20	64	1924 518	870.00
▪		20 - 25	68	1924 520	870.00
▪		25 - 30	68	1924 522	901.00
▪		30 - 40	76	1924 524	948.00
▪		40 - 50	76	1924 526	953.00
▪		50 - 60	79	1924 528	1037.00
▪		60 - 70	79	1924 530	1078.00
▪		70 - 85	97	1924 532	1115.00
▪		85 - 100	97	1924 534	1167.00
▪		100 - 125	132	1924 536	1438.00
▪		125 - 150	132	1924 538	1657.00
▪		150 - 175	132	1924 540	1771.00
▪		175 - 200	132	1924 542	1980.00



1726506



172650660

### Accessories

- DIGI-MET® Indicator
- DIGI-MET® Indicator with integrated wireless

### Order no.

- 1726 506
- 172650 660

### List price EUR

- 380.00
- 425.00

Calibration certificate for pistol and head only possible in combination with an Indicator



## 1924 DIGI-MET® Set of 3 point internal measuring pistols



### Model

- For through holes
- From measuring range 12 mm for through and blind holes
- From measuring range 12 mm with carbide tipped measuring faces
- Digital indicator recommended as display device

### Delivery

- Plastic case
- Incl. setting ring
- Without display device
- Calibration certificate **for setting ring** included

Measuring range mm	Number of devices	Order no.	List price EUR
6 - 12	3	1924 574	1459.00
12 - 20	2	1924 576	1250.00
20 - 50	4	1924 578	2084.00
50 - 100	4	1924 580	2709.00

Calibration certificate for pistol and head on request, only possible in combination with an Indicator

## 1924 DIGI-MET® Basic unit for 3 point internal measuring pistols



### Model

- Mounting thread for changing of measuring heads
- Support for indicators with shaft  $\varnothing$  8 mm
- Measuring range 6-100 mm incl. adapter for 6-20 mm

### Delivery

- Plastic case

Measuring range mm	Order no.	List price EUR
6 - 100	1924 100	500.00
20 - 100	1924 200	500.00
100 - 200	1924 300	584.00

### Accessories

Accessories	Order no.	List price EUR
Replacement adapter 6-20 mm for measuring pistol 1924 100	1924 190	79.00

Single measuring heads on page 116



## 1922 Individual measuring heads for 1923 / 1924



1922 512



1922 534

### Model

- Self centering measuring head with three anvils, offset at intervals of 120°
- From measuring range 12 mm with carbide tipped measuring faces
- From measuring range 12 mm for through and blind holes
- From measuring range 40 mm, measuring heads are made of aluminium to reduce weight
- Can only be used on digital internal micrometers

⊗	⊗	Measuring range mm	Order no.	List price EUR
		6 - 8	1922 510	302.00
		8 - 10	1922 512	302.00
		10 - 12	1922 514	307.00
		12 - 16	1922 516	307.00
		16 - 20	1922 518	318.00
		20 - 25	1922 520	328.00
		25 - 30	1922 522	339.00
		30 - 40	1922 524	380.00
		40 - 50	1922 526	380.00
		50 - 60	1922 528	453.00
		60 - 70	1922 530	464.00
		70 - 85	1922 532	479.00
		85 - 100	1922 534	495.00
		100 - 125	1922 536	724.00
		125 - 150	1922 538	880.00
		150 - 175	1922 540	953.00
		175 - 200	1922 542	985.00

## 1920 Measuring depth extensions for 3 point internal micrometers



### Model

- Suitable for devices 1920, 1921, 1923 and 1924



⊗	⊗	Measuring range mm	Length mm	Order no.	List price EUR
		6 - 12	75	1920 910	92.00
		12 - 20	75	1920 914	98.00
		20 - 30	100	1920 920	103.00
		30 - 200	100	1920 924	124.00



## 0882 Depth micrometers



DIN  
863-2

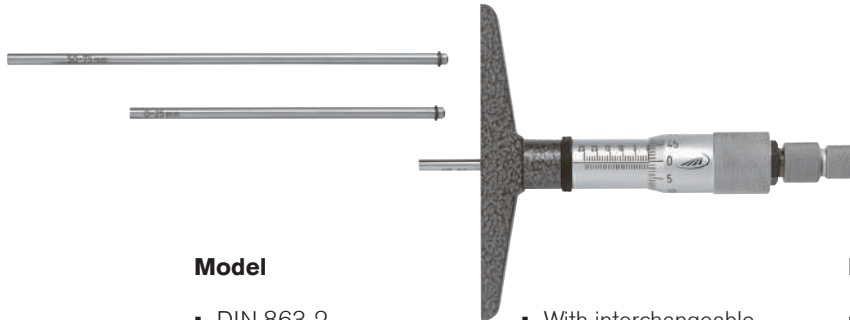

### Model

- DIN 863-2
- Reading: 0.01 mm
- Reading parts are satin chrome finished
- Locking ring
- Friction coupling

### Delivery

- Wooden case

- With interchangeable steel measuring inserts dia. 4 mm
- Hardened measuring faces

»	¼	Measuring range mm	Length of beam mm	Pitch mm	Thimble dia. mm	Error limit mm	Order no.	List price EUR
<b>Measuring faces dia. 0.8 mm, length 8.5 mm</b>								
		0 - 50	50	0.5	20	0.004	0882 300	274.00
		0 - 75	50	0.5	20	0.005	0882 301	298.00
		0 - 100	100	0.5	20	0.005	0882 303	327.00
		0 - 150	100	0.5	20	0.006	0882 304	383.00
		0 - 300	100	0.5	20	0.009	0882 306	617.00

## 0886 Micrometer heads



DIN  
863-2



0886 503



0886 507

### Model

- DIN 863-2
- Reading: 0.01 mm
- Reading parts are satin chrome finished
- Carbide measuring faces

### Delivery

- Plastic case

»	¼	Measuring range mm	Spindle dia. mm	Thimble dia. mm	Attachment dia. mm	Error limit mm	Description	Order no.	List price EUR
		0 - 6.5	3.5	9.5	6.0	0.003	without ratchet stop	0886 503	24.40
		0 - 13	6.5	13.5	9.5	0.003	without ratchet stop	0886 505	28.10
		0 - 25	6.5	18	12	0.003	with ratchet stop	0886 507	24.40
		0 - 25	8	18	12	0.003	ratchet stop, non-rotating spindle	0886 513	43.30



# SAMPLES INDICATORS

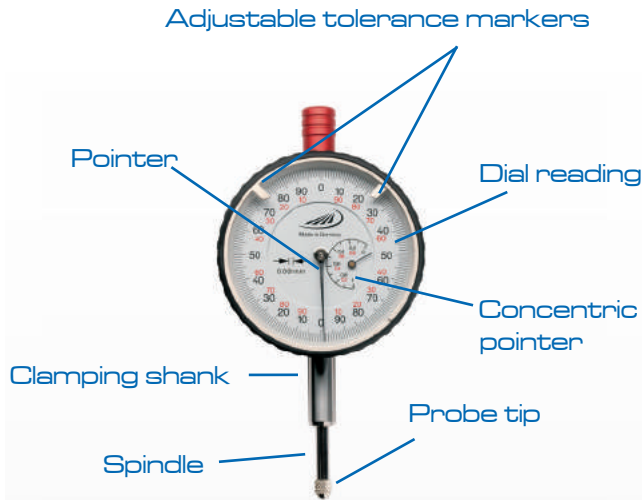

## Specifications

- Housing made from metal or polyamide
- Replacement probe tips M 2,5
- Shockproof devices available
- Water and oil proof devices available

## Electronic functions

**QuickStart Electronic:**  
Moving the spindle starts your measurement



**QuickLock Function:**  
Single keys can be locked individually



**Data Variable:**  
Interface for USB, RS 232 & Digimatic



**Integrated data transmission**  
(Integrated Wireless)



Individual tolerance limit values

Data Variable Interface

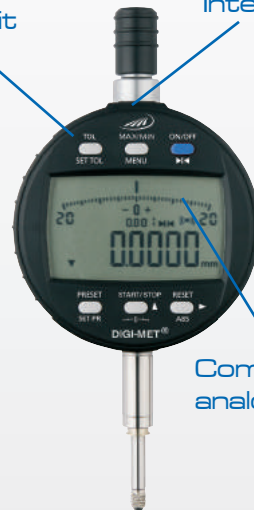

Combined analogue / digital display

# 1734i

with integrated wireless

## Matching accessories for our Indicators



MEASURING TABLES



MEASURING STANDS

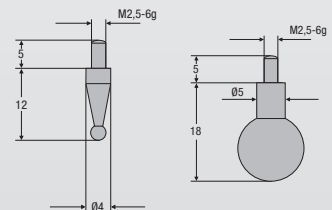

MEASURING INSERTS

### **3. CHAPTER INDICATORS**

120	Indicators
127	Dial gauges
132	Precision indicators
133	Accessories for dial gauges and precision indicators
135	Measuring inserts for dial gauges
139	Dial test indicators
141	Depth gauges, depth measuring base
142	Dial thickness gauges
144	Internal and external caliper gauges
148	Internal bore gauges for blind holes
149	Crankshaft gauges / Length measuring instruments
150	Length measuring instruments for internal incisions
151	Universal comparator gauge
154	Comparator gauge UHRTAST
160	Magnetic measuring stands
164	Measuring tables
167	Bench centres
174	Shaft measuring instruments





## 1722 / 1723 / 1724 DIGI-MET® Indicators



1722 502



1723 502



1724 502

### Model

- Outer ring (Bezel) Ø 60 mm
- Replacement probe tip M 2.5
- Protection class IP52
- Clamping shank Ø 8 mm
- LCD display with 12 mm high numerals
- Accuracy according to factory standard

### Functions

- ON / OFF
- **Quick-Start**
- **Quick-Lock** (key lock)
- Set to zero at any point
- Reversal of counting direction
- mm / inch switching
- Individual key lock

### Delivery

- Cardboard box

Measuring span	Resolution		Error limit	Measuring force	Order no.	List price
	mm	inch				
12.5	0.01	.0005	0.02	0.5 - 1	1722 502	142.00
12.5	0.005	.0001	0.015	0.5 - 1	1723 502	179.00
12.5	0.001	.00005	0.005	0.5 - 1	1724 502	296.00



1998720



1997501



1998501

### Accessories

	Order no.	List price
Battery, 3V-Lithium, CR 2032	0220 704	3.90
Data cable Data Variable to USB	1998 720	72.00
Data cable Data Variable to RS232	1997 501	50.00
Data cable Data Variable to digimatic	1998 501	64.00
Cable release (12,5 mm)	1739 920	14.90



## 1726 / 1728 DIGI-MET® Indicators



1726 502



1728 502

### Model

- Aluminium housing
- Hardened stainless steel spindle
- Outer ring (Bezel) Ø 60 mm
- Replacement probe tip M 2.5
- Protection class IP42
- Clamping shank Ø 8 mm
- Display unit can be rotated through 280°
- LCD display with 11 mm high numerals
- Factory standard

### Functions

- ON / OFF
- Quick-Start
- Quick-Lock (key lock)
- Set to zero at any point
- mm / inch switching
- ABS (display can be set to zero without losing the Preset value)
- TOL (tolerance value input)
- Reversal of counting direction
- Factor input

### Delivery

- Cardboard box

⊞	Measuring span	Resolution		Error limit		Repeatability	Measuring force	Order no.	List price	
		mm	inch	total span mm	partial span** mm					mm
<b>Reading 0.001 mm</b>										
	12.5	0.001*	.00005	0.004	0.002	0.001	0.65 - 0.9	1726 502	345.00	
	25	0.001*	.00005	0.004	0.002	0.001	0.65 - 1.15	1726 506	380.00	
	50	0.001*	.00005	0.007	0.002	0.001	1.25 - 2.7	1726 510	669.00	
	100	0.001*	.00005	0.008	0.002	0.001	1.6 - 3.5	1726 514	828.00	
<b>Reading 0.01 mm</b>										
	12.5	0.01	.0005	0.02		0.01	0.65 - 0.9	1728 502	289.00	
	25	0.01	.0005	0.02		0.01	0.65 - 1.15	1728 506	368.00	
	50	0.01	.0005	0.02		0.01	1.25 - 2.7	1728 510	600.00	
	100	0.01	.0005	0.02		0.01	1.6 - 3.5	1728 514	768.00	

\* Reading switchable: 0.0005 / 0.001 / 0.002 / 0.005 / 0.010 mm

\*\* Partial span = 25 steps by step value 0.0005 mm



1998720

1998501

1997501

### Accessories

	Order no.	List price
Battery, 3V-Lithium, CR 2450	1998 770	5.90
Data cable Data Variable to USB	1998 720	72.00
Data cable Data Variable to RS232	1997 501	50.00
Data cable Data Variable to digimatic	1998 501	64.00
Cable release (12,5 mm)	1739 910	40.00



## 1730 / 1732 DIGI-MET® Indicators



### Model

- Aluminium housing
- Outer ring (Bezel) Ø 60 mm
- Replacement probe tip M 2.5
- Protection class IP54
- Clamping shank Ø 8 mm
- Display unit can be rotated through 280°
- LCD display with 11 mm high numerals
- Factory standard

### Functions

- ON / OFF
- Quick-Start**
- Quick-Lock** (key lock)
- Set to zero at any point
- mm / inch switching
- ABS (display can be set to zero without losing the Preset value)
- TOL (tolerance value input)
- Reversal of counting direction

### Delivery

- Cardboard box

Measuring span	Resolution			Error limit		Repeatability	Measuring force	Order no.	List price
	mm	mm	inch	total span mm	partial span** mm				
12.5	0.001	.00005	0.004	0.002	0.001	0.65 - 0.9	1730 502	382.00	
25	0.001	.00005	0.004	0.002	0.001	0.65 - 1.15	1730 506	431.00	

\* Reading switchable: 0.0005 / 0.001 / 0.002 / 0.005 / 0.010 mm

\*\* Partial span= 25 steps by step value 0.0005 mm



1998720

1998501

1997501

### Accessories

	Order no.	List price
Battery, 3V-Lithium, CR 2450	1998 770	5.90
Data cable Data Variable to USB	1998 720	72.00
Data cable Data Variable to RS232	1997 501	50.00
Data cable Data Variable to digimatic	1998 501	64.00
Cable release (12,5 mm)	1739 910	40.00



## 1734 DIGI-MET® indicators with combined analogue / digital display



1734 502



1734 506

### Model

- Aluminium housing
- Hardened stainless steel spindle
- Outer ring (Bezel) Ø 60 mm
- Replacement probe tip M 2.5
- Protection class IP42
- Clamping shank Ø 8 mm
- Display unit can be rotated through 280°
- LCD display with 8.5 mm high numerals
- Factory standard

### Functions

- ON / OFF
- Quick-Start
- Quick-Lock (key lock)
- Set to zero at any point
- mm / inch switching
- ABS (display can be set to zero without losing the Preset value)
- TOL (tolerance value input)
- MIN / MAX
- TIR (MIN-MAX differential)
- Reversal of counting direction

### Delivery

- Cardboard box

Measuring span	Resolution		Error limit		Repeatability	Measuring force	Order no.	List price
	mm	inch	total span mm	partial span** mm				
12.5	0.001	.00005	0.004	0.002	0.001	0.65 - 0.9	1734 502	397.00
25	0.001	.00005	0.004	0.002	0.001	0.65 - 1.15	1734 506	455.00

\* Reading switchable: 0.0005 / 0.001 / 0.002 / 0.005 / 0.010 mm

\*\* Partial span= 25 steps by step value 0.0005 mm



1998720

1998501

1997501

### Accessories

	Order no.	List price EUR
Battery, 3V-Lithium, CR 2450	1998 770	5.90
Data cable Data Variable to USB	1998 720	72.00
Data cable Data Variable to RS232	1997 501	50.00
Data cable Data Variable to digimatic	1998 501	64.00
Cable release (12,5 mm)	1739 910	40.00



## 1734 DIGI-MET® indicator with combined analogue / digital display

for comparator gauges



1734 522

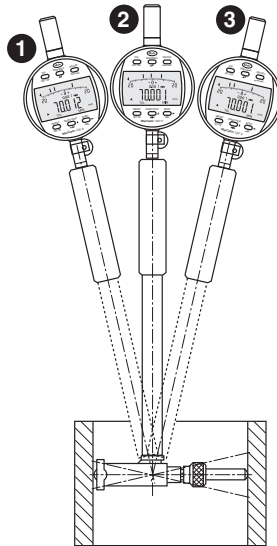

### Application

The turning point can be determined automatically in measurements with a 2 point internal measuring device through commuting. The actual value is detected and stored by the MIN function and appears on the display.

### Model

- Aluminium housing
- Hardened stainless steel spindle
- Outer ring (Bezel) Ø 60 mm
- Replacement probe tip M 2.5
- Protection class IP42
- Clamping shank Ø 8 mm
- Display unit can be rotated through 280°
- LCD display with 8.5 mm high numerals
- Factory standard

### Functions

- ON / OFF
- Quick-Start**
- Quick-Lock** (key lock)
- Set to zero at any point
- mm / inch switching
- ABS (display can be set to zero without losing the Preset value)
- TOL (tolerance value input)
- MIN / MAX
- Reversal of counting direction
- Factor input
- Individual key lock
- Variable data output RS 232 + Digimatic + USB
- PRESET-Function (setting a numerical value)

### Delivery

- Cardboard box

Measuring span	Resolution		Error limit		Repeatability	Measuring force	Order no.	List price
	mm	mm	inch	total span mm				
12.5	0.001	.00005	0.004	0.002	0.001	0.65 - 0.9	1734 522	515.00

\* Reading switchable: 0.0005 / 0.001 / 0.002 / 0.005 / 0.010 mm

\*\* Partial span = 25 steps by step value 0.0005 mm

### Accessories

	Order no.	List price
Battery, 3V-Lithium, CR 2450	1998 770	5.90
Data cable Data Variable to USB	1998 720	72.00
Data cable Data Variable to RS232	1997 501	50.00
Data cable Data Variable to digimatic	1998 501	64.00
Cable release (12,5 mm)	1739 910	40.00



1998720

1998501

1997501



## 1726i / 1734i DIGI-MET® Indicators with integrated wireless



1726 50260



1734 50260



## integrated IW wireless

Wireless Data Transmission



### Model

- Aluminium housing
- Outer ring (Bezel) Ø 60 mm
- Replacement probe tip M2.5
- Protection class IP42
- Clamping shank Ø 8mm
- Display can be rotated through 280°
- LCD display with 11 mm high numerals
- Factory standard

### Functions

- ON / OFF
- Quick-Start**
- Quick-Lock** (key lock)
- Set to zero at any point
- mm / inch switching
- ABS (display can be set to zero without losing the Preset value)
- TOL (tolerance value input)
- Reversal of counting direction

- Factor input
- Individual key lock
- PRESET-Function (setting a numerical value)
- Variable data output RS 232 + Digimatic + USB
- Integrated Wireless

### Delivery

- Cardboard box

More information on our i-series and Integrated Wireless on page 277

Measuring span	Resolution		Error limit		Repeatability	Measuring force	Order no.	List price
	mm	mm	inch	total span mm				
12.5	0.0005	.00002	0.004	0.002	0.001	0.65 - 0.9	1726 50260	391.00
25	0.0005	.00002	0.004	0.002	0.001	0.65 - 1.15	1726 50660	425.00
<b>With combined analogue / digital display and MIN / MAX / TIR Function</b>								
12.5	0.0005	.00002	0.004	0.002	0.001	0.65 - 0.85	1734 50260	441.00
25	0.0005	.00002	0.004	0.002	0.001	0.65 - 0.9	1734 50660	497.00

\* Reading switchable: 0.0005 / 0.001 / 0.002 / 0.005 / 0.010 mm  
 \*\* Partial span= 25 steps by step value 0.0005 mm



1998780

### Accessories

	Order no.	List price
Battery, 3V-Lithium, CR 2450	1998 770	5.90
Data cable Data Variable to USB	1998 720	72.00
Data cable Data Variable to RS232	1997 501	50.00
Data cable Data Variable to digimatic	1998 501	64.00
Cable release (12,5 mm)	1739 910	40.00
i-Stick USB-receiver for Integrated Wireless	1998 780	95.00

Integrated Wireless is intended to be sold in the European Economic Area only



## 0691 DIGI-MET® Indicators



### Model

- Aluminium housing
- Outer ring (Bezel) Ø 60 mm
- Replacement probe tip M 2.5
- Protection class IP51
- Water and coolant resistant
- Clamping shank Ø 8 mm
- Display unit can be rotated through 270°
- LCD display with 11 mm high numerals
- Factory standard

### Functions

- ON / OFF
- Set to zero at any point
- mm / inch switching
- PRESET-Function (setting a numerical value)
- Reversal of counting direction
- Data interface RS232 Proximity (cable no. 1998 760)

### \* Additional functions: models 0691 751 + 0691 753

- TOL (tolerance value input)
- Factor input
- MIN / MAX
- TIR (MIN-MAX differential)

### Delivery

- Cardboard box



0691 733



0691 735



0691 747



Measuring span	Resolution		Error limit	Order no.	List price
	mm	mm / inch			
<b>Reading 0.01 mm</b>					
12.5	0.01	.0005	0.01	0691 731	378.00
25	0.01	.0005	0.01	0691 733	433.00
50	0.01	.0005	0.02	0691 735	943.00
100	0.01	.0005	0.02	0691 737	1063.00
<b>Reading 0.001 mm</b>					
12.5	0.001	.00005	0.004	0691 741	467.00
25	0.001	.00005	0.005	0691 743	512.00
50	0.001	.00005	0.007	0691 745	1045.00
100	0.001	.00005	0.008	0691 747	1207.00
<b>Reading 0.001 mm, with additional functions*</b>					
12.5	0.001	.00005	0.003	0691 751	543.00
25	0.001	.00005	0.004	0691 753	600.00



## 0701 Small dial gauges with lightweight plastic housing



### Model

- Lightweight housing made of polyamide
- Measuring spindle is made of stainless steel
- Replacement probe tip M 2.5
- Clamping shank Ø 8 mm
- DIN 878

### Delivery

- Fitted case

**DIN  
878**

☒ ☒	Measuring span mm	Scale graduation value mm	Range per rev. mm	Outer ring (Bezel) Ø mm	Order no.	List price EUR
<b>Small dial gauge</b>						
	5	0.01	0.5	40	0701 101	41.70
<b>Shockproof small dial gauge</b>						
	5	0.01	0.5	40	0701 102	52.00

3

## 0708 Small dial gauges



0708 101



0708 102

### Model

- Metal housing
- Measuring spindle is made of stainless steel
- Replacement probe tip M 2.5
- Clamping shank Ø 8 mm
- With a revolution counter
- DIN 878

### Delivery

- Fitted case

**DIN  
878**

☒ ☒	Measuring span mm	Scale graduation value mm	Range per rev. mm	Outer ring (Bezel) Ø mm	Order no.	List price EUR
	10	0.01	0.5	40	0708 101	90.00
	5	0.01	0.5	40	0708 102	57.00
	3	0.01	0.5	32	0708 103	69.00
	3	0.01	0.5	40	0708 104	46.90
<b>Shockproof small dial gauge</b>						
	3	0.01	0.5	40	0708 105	57.00
	5	0.01	0.5	40	0708 106	76.00





## 0701 Dial gauges



DIN  
878



0701 106



0701 110

### Model

- Measuring spindle is made of stainless steel
- Replacement probe tip M 2.5
- Clamping shank Ø 8 mm
- DIN 878
- 0701 103 = Factory standard

### Delivery

- Fitted case

✕	☒	Measuring span mm	Scale graduation value mm	Range per rev. mm	Outer ring (Bezel) Ø mm	Order no.	List price EUR
		<b>Dial gauge, plastic housing</b>					
		10	0.01	1	58	0701 103	24.00
		<b>Dial indicator with shock protection, injection-molded housing</b>					
		10	0.01	1	58	0701 106	25.00
		<b>Dial gauge, metal housing</b>					
		10	0.01	1	58	0701 110	41.70
		<b>Shockproof dial gauge, metal housing</b>					
		10	0.01	1	58	0701 111	47.90

## 0703 Dial gauges with extended measuring range



0703 101

### Model

- Metal housing
- Measuring spindle is made of stainless steel
- Replacement probe tip M 2.5
- Clamping shank Ø 8 mm
- With a concentric pointer
- Factory standard

### Delivery

- Fitted case

✕	☒	Measuring span mm	Scale graduation value mm	Range per rev. mm	Outer ring (Bezel) Ø mm	Order no.	List price EUR
		30	0.01	1	58	0703 101	103.00
		50	0.01	1	58	0703 104	143.00
		80	0.01	1	58	0703 107	287.00



## 0704 Shockproof dial gauges



0704 105



0704 109

### Model

- Metal housing
- Measuring spindle is made of stainless steel
- Replacement probe tip M 2.5
- Clamping shank Ø 8 mm
- Shockproof

### Delivery

- Fitted case

DIN 878

☒	☒	Measuring span mm	Scale graduation value mm	Range per rev. mm	Outer ring (Bezel) Ø mm	Order no.	List price EUR
<b>Revolution counter: DIN 878</b>							
		10	0.01	1	58	0704 105	73.00
<b>With fine adjustment of the pointer: DIN 878</b>							
		10	0.01	1	58	0704 106	90.00
<b>Concentric pointer: Factory standard</b>							
		30	0.01	1	58	0704 109	118.00
		50	0.01	1	58	0704 110	152.00

3

## 0707 Water and oil proof dial gauges



0707 102

### Model

- Metal housing, water and oil proof
- Protection class IP67
- Measuring spindle is made of stainless steel
- Replacement probe tip M 2.5
- Clamping shank Ø 8 mm
- Rubber bellows
- Shockproof
- Outer ring (Bezel) can be rotated through 360°
- DIN 878

### Delivery

- Fitted case



DIN 878

☒	☒	Measuring span mm	Scale graduation value mm	Range per rev. mm	Outer ring (Bezel) Ø mm	Order no.	List price EUR
		3	0.01	0.5	44.5	0707 101	129.00
		10	0.01	1	61.5	0707 102	110.00



## 0700 Dial gauges, graduation 0.1 mm



0700 102



0700 104

### Model

- Metal housing
- Measuring spindle is made of stainless steel
- Replacement probe tip M 2.5
- Clamping shank Ø 8 mm
- Factory standard

### Delivery

- Fitted case

	Measuring span mm	Scale graduation value mm	Range per rev. mm	Outer ring (Bezel) Ø mm	Order no.	List price EUR
	10	0.1	10	40	0700 100	63.00
	5	0.1	5	40	0700 101	63.00
	10	0.1	10	58	0700 102	47.90
<b>Straight line revolution counter</b>						
	30	0.1	10	58	0700 104	55.00

## 0702 Dial gauge with concentric mm display



0702 106

### Model

- Metal housing
- Measuring spindle is made of stainless steel
- Replacement probe tip M 2.5
- Clamping shank Ø 8 mm
- With a concentric pointer
- DIN 878

### Delivery

- Fitted case

**DIN  
878**

	Measuring span mm	Scale graduation value mm	Range per rev. mm	Outer ring (Bezel) Ø mm	Order no.	List price EUR
	10	0.01	1	58	0702 106	64.00



## 0705 Precision dial gauges



0705 102

### Model

- Metal housing
- Measuring spindle is made of stainless steel
- Replacement probe tip M 2.5
- Clamping shank Ø 8 mm
- With a revolution counter
- Factory standard

### Delivery

- Fitted case

		Measuring span mm	Scale graduation value mm	Range per rev. mm	Outer ring (Bezel) Ø mm	Order no.	List price EUR
		1	0.001	0.2	40	0705 102	113.00
		1	0.001	0.2	58	0705 104	113.00
		5	0.001	0.2	58	0705 105	118.00
<b>Precision shockproof dial gauge</b>							
		1	0.001	0.2	40	0705 107	120.00
		5	0.001	0.2	58	0705 109	146.00

## 0706 Error free, shockproof dial gauge



0706 102

### Model

- Metal housing
- Measuring spindle is made of stainless steel
- Replacement probe tip M 2.5
- Clamping shank Ø 8 mm
- DIN 878

### Delivery

- Fitted case

DIN 878

		Measuring span mm	Scale graduation value mm	Dial reading	Overtravel mm mm	Outer ring (Bezel) Ø mm	Order no.	List price EUR
		0.8	0.01	40-0-40	1	58	0706 102	73.00



## 0709 Dial gauges with reverse action plunger



### Model

- Metal housing
- Measuring spindle is made of stainless steel
- Replacement probe tip M 2.5
- Clamping shank  $\varnothing$  8 mm
- Factory standard

### Delivery

- Fitted case

☒ ☒	Measuring span	Scale graduation value	Range per rev.	Outer ring (Bezel)	Order no.	List price
	mm	mm	mm	$\varnothing$ mm		EUR
	3	0.01	0.5	40	0709 101	108.00
	5	0.01	1	58	0709 108	129.00

## 0712 Dial comparator gauge MICROTAST



0712 121



0712 124

### Model

- Measuring spindle is made of hardened stainless steel
- Longer measuring spindle
- Replacement probe tip M 2.5
- Clamping shank  $\varnothing$  8 mm
- Tolerance markers
- Shockproof
- Fine adjustment
- DIN 879

### Delivery

- Fitted case

**DIN  
879**

☒ ☒	Measuring span	Scale graduation value	Dial reading	Overtravel	Order no.	List price
	mm	mm		mm		EUR
	0.5	0.01	25-0-25	2.5	0712 121	155.00
	0.1	0.001	50-0-50	3	0712 124	190.00



## 0710 Magnetic back



### Model

- For dial gauges with outer ring (Bezel) Ø 58 mm
- Allows dial gauges to be used without a holder or a stand
- Magnetic force 220 N
- Cannot be used in conjunction with dial gauges 0701 103 and 0701 106 or any digital gauges

☒	☒	Order no.	List price EUR
		0710 101	53.00

## 0710 Lug back

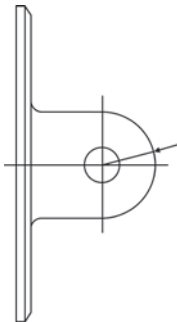

### Model

- Ø 5 mm
- For retrofitting
- Cannot be used in conjunction with dial gauges 0701 103 and 0701 106 or any digital gauges

☒	☒	Diameter mm	Order no.	List price EUR
<b>For dial gauges with an outer ring (Bezel) dia. 40 mm</b>				
		5	0710 102	6.60
<b>For dial gauges with an outer ring (Bezel) dia. 58 mm</b>				
		5	0710 103	6.80

## 0710 Spindle lifting lever

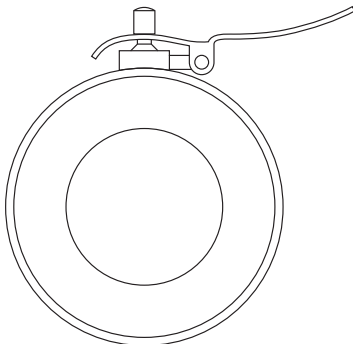

### Model

- For dial gauges with a measuring span of max. 10 mm
- Cannot be used in conjunction with dial gauges 0701 103 and 0701 106 or any digital gauges

☒	☒	Order no.	List price EUR
<b>For dial gauges with an outer ring (Bezel) dia. 40 mm</b>			
		0710 104	10.50
<b>For dial gauges with an outer ring (Bezel) dia. 58 mm</b>			
		0710 105	10.50



## 0724 Angle lever attachment



### Model

- Clamping shank  $\varnothing$  8 mm
- Smallest measurable hole: 6 mm

### Delivery

- Excludes dial gauge

	Measuring depth mm	Order no.	List price EUR
	60	0724 101	47.90

## 0710 Extensions for dial gauges



### Model

- Special steel
- Thread M 2,5

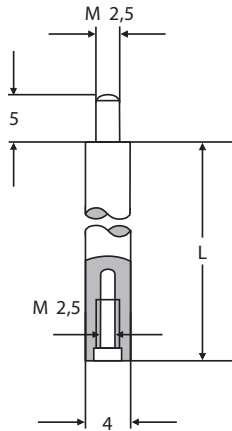

	Length mm	Order no.	List price EUR
	10	0710 111	4.50
	15	0710 112	4.50
	20	0710 113	4.50
	25	0710 114	4.50
	30	0710 115	4.50
	35	0710 116	4.50
	40	0710 117	4.50
	45	0710 118	4.50
	50	0710 119	4.50
	55	0710 120	4.50
	60	0710 121	4.50
	65	0710 122	4.50
	70	0710 123	4.50
	75	0710 124	4.50
	80	0710 125	4.50
	85	0710 126	4.50
	90	0710 127	4.50
	95	0710 128	4.50
	100	0710 129	4.50



## 0710 Measuring inserts M 2.5

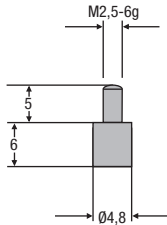

Material contact surface	Length mm	Order no.	List price EUR
Special steel	6	0710 161	3.60
Carbide	6	0710 261	24.80

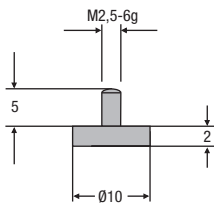

Material contact surface	Length mm	Order no.	List price EUR
Special steel	2	0710 162	4.70
Carbide	2	0710 262	40.00

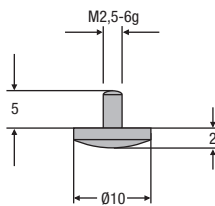

Material contact surface	Length mm	Order no.	List price EUR
Special steel	2	0710 163	5.40
Carbide	2	0710 263	48.20

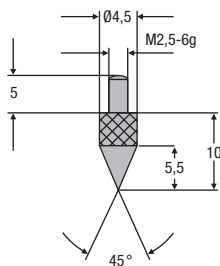

Material contact surface	Length mm	Order no.	List price EUR
Special steel	10	0710 164	5.40
Carbide	10	0710 264	46.70

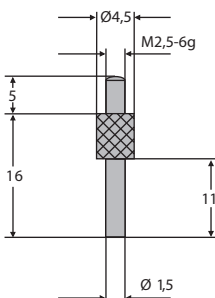

Material contact surface	Length mm	Diameter	Order no.	List price EUR
Special steel	16	1.5 mm	0710 165	6.80
Carbide	16	1.5 mm	0710 265	21.50





## 0710 Measuring inserts M 2.5

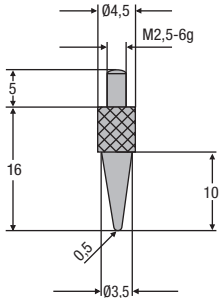

Material contact surface	Length mm	Order no.	List price EUR
Special steel	16	0710 166	4.90

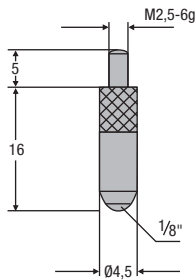

Material contact surface	Length mm	Order no.	List price EUR
Special steel	16	0710 167	3.40
Carbide	16	0710 267	11.40
Ruby	16	0710 367	8.90
Sapphire	16	0710 467	8.90

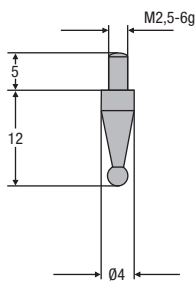

Material contact surface	Length mm	Ball diameter mm	Order no.	List price EUR
<b>Tolerance of the ball diameter +/- 1 µm</b>				
Special steel	12	1	0710 169	6.80
Special steel	12	1.5	0710 170	6.80
Special steel	12	2	0710 171	6.80
Special steel	12	2.5	0710 172	6.80
Special steel	12	3	0710 173	6.80
Special steel	12	3.5	0710 174	6.80
Special steel	12	4	0710 175	6.80
Special steel	12	4.5	0710 176	6.80
Special steel	12	5	0710 177	6.80
Special steel	12	5.5	0710 178	6.80
Special steel	12	6	0710 179	6.80
Special steel	12	6.5	0710 180	6.80

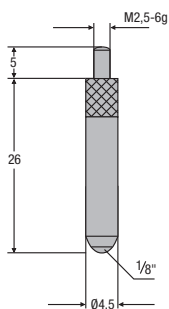

Material contact surface	Length mm	Order no.	List price EUR
Special steel	26	0710 168	3.40
Carbide	26	0710 268	11.40
Ruby	26	0710 368	8.90
Sapphire	26	0710 468	8.90



## 0710 Measuring inserts M 2.5

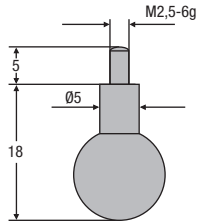

Material contact surface	Length mm	Ball diameter mm	Order no.	List price EUR
Special steel	18	7	0710 181	6.80
Special steel	18	7.5	0710 182	6.80
Special steel	18	8	0710 183	6.80
Special steel	18	8.5	0710 184	6.80
Special steel	18	9	0710 185	6.80
Special steel	18	9.5	0710 186	6.80
Special steel	18	10	0710 187	6.80
Special steel	18	10.5	0710 188	6.80
Special steel	18	11	0710 189	6.80

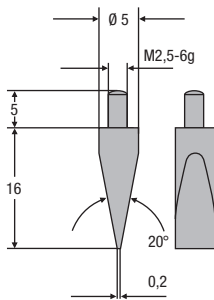

Material contact surface	Length mm	Order no.	List price EUR
<b>With locknut</b>			
Special steel	16	0710 192	7.20
Carbide	16	0710 292	51.00

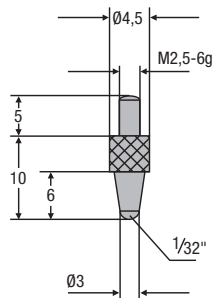

Material contact surface	Length mm	Order no.	List price EUR
Special steel	10	0710 193	3.60

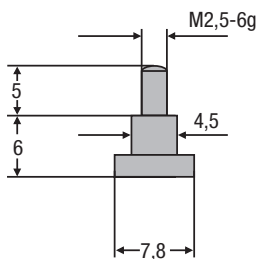

Material contact surface	Length mm	Order no.	List price EUR
Special steel	6	0710 194	4.90



## 0710 Measuring inserts M 2.5

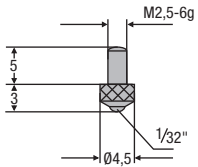

Material contact surface	Length mm	Order no.	List price EUR
Special steel	3	0710 195	1.10

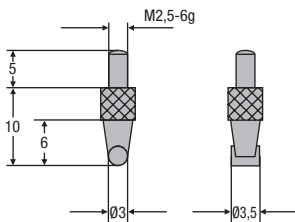

Material contact surface	Length mm	Diameter	Order no.	List price EUR
<b>With locknut</b>				
Special steel	10	3 x 3,5 mm	0710 196	7.90

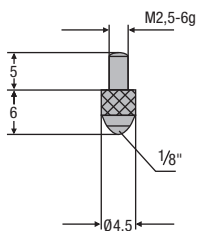

Material contact surface	Length mm	Order no.	List price EUR
Special steel	6	0710 197	1.10
Carbide	6	0710 297	4.70
Ruby	6	0710 397	6.40
Sapphire	6	0710 497	6.40



## 0715 Dial test indicators



0715 101



0715 201

### Model

- Carbide tipped measuring inserts, Ø 2.0 mm
- Form A in accordance to DIN 2270
- Revolving dial
- 3-piece swallow tail guide
- Automatic reversal of the counting direction
- Measuring force 0.15 N

### Delivery

- Fitted case

**DIN**  
**2270**

⊗	☒	Measuring range mm	Scale graduation value mm	Range per rev. mm	Stylus length mm	Dial reading	Outer ring (Bezel) Ø mm	Order no.	List price EUR
		± 0.4	0.01	0.8	14.5	0-40-0	30	0715 101	80.00
		± 0.4	0.01	0.8	14.5	0-40-0	40.5	0715 103	90.00
		± 0.25	0.01	0.5	41.2	0-25-0	30	0715 201	126.00
		± 0.1	0.002	0.2	14.5	0-100-0	40.5	0715 303	113.00
		± 0.1	0.002	0.2	14.5	0-100-0	30	0715 305	107.00
		± 0.5	0.01	0.5	32.3	0-50-0	40.5	0715 307	160.00

## 0715 Clamping shanks for dial test indicators

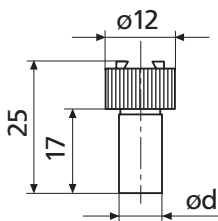

### Model

- With swallow tail mounting for dial test indicators and clamping nut

⊗	☒	Diameter	Order no.	List price EUR
		4h6	0715 903	12.10
		8h6	0715 907	12.10

## 0715 Measuring inserts with carbide ball

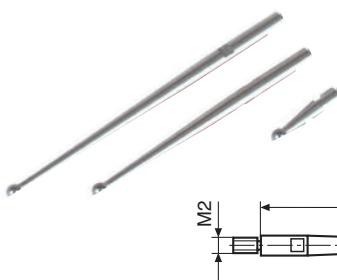

⊗	☒	Length mm	Ball diameter mm	Order no.	List price EUR
		14.5	1	0715 915	16.90
		14.5	2	0715 917	13.30
		14.5	3	0715 919	13.30
		32.3	1	0715 921	18.70
		32.3	2	0715 922	14.10
		32.3	3	0715 923	14.00
		41.2	1	0715 925	17.10
		41.2	2	0715 926	13.30
		41.2	3	0715 929	13.30



## 0715 Key for measuring inserts



		Order no.	List price EUR
		0715 940	2.50

## 0715 Universal clamp

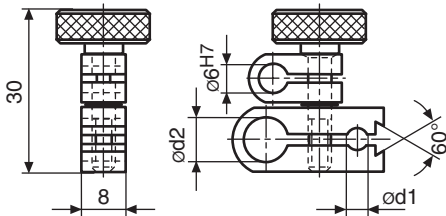

		Diameter mm	Order no.	List price EUR
		8	0715 950	25.30

## 0715 Holder

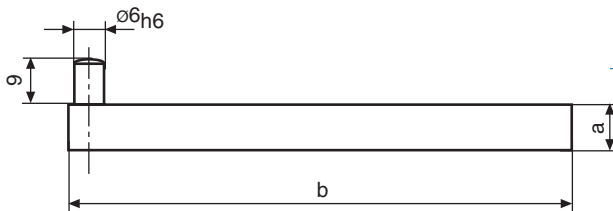

		Length mm	Cross-section mm	Order no.	List price EUR
		100	9 x 9	0715 955	16.00



## 0716 Dial depth gauges with a measuring base



0716 101



0716 111

### Model

- Measuring base is made of stainless steel, hardened
- Replacement probe tip M 2.5
- Revolving dial
- Factory standard

### Delivery

- Cardboard box

		Measuring range mm	Reading mm	Contact surface mm	Range per rev. mm	Scale dia. mm	Order no.	List price EUR
		0 - 10	0.01	100 x 15	1	58	0716 101	140.00
		<b>Concentric pointer</b>						
		0 - 30	0.01	150 x 15	1	58	0716 102	204.00
		0 - 30	0.01	100 x 15	1	58	0716 105	183.00
		<b>Prismatic base</b>						
		0 - 30	0.01	for dia. 10 - 100	1	58	0716 111	270.00

## 0716 Depth measuring base for indicators



0716 192

### Model

- Special steel, chrome plated
- Mounting for indicator Ø 8 mm

### Delivery

- Cardboard box

		Contact surface mm x mm	Order no.	List price EUR
		80 x 15	0716 192	59.00
		100 x 15	0716 194	73.00
		150 x 15	0716 196	94.00
		<b>Prismatic bridge</b>		
		for dia. 10 - 100	0716 198	125.00



## 0718 Dial thickness gauges



0718 101



0718 112



### Model

- Frame is made of aluminium alloy
- Factory standard
- When ordering please specify the gauge form

### Delivery

- Cardboard box

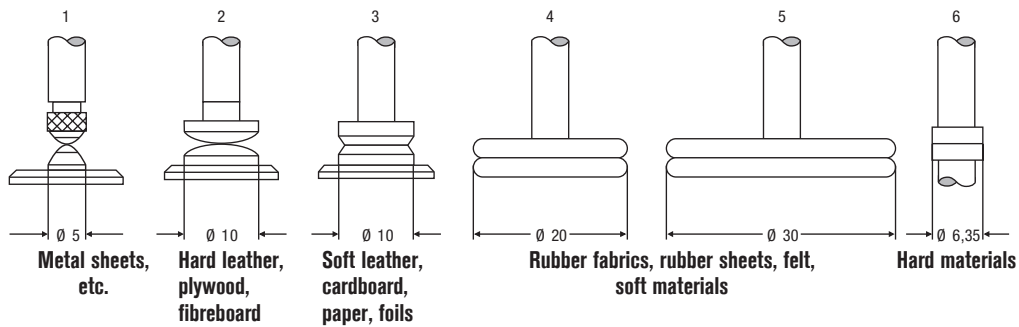

Measuring range mm	Reading mm	Frame depth mm	Probe type	Order no.	List price EUR
0 - 10	0.1	15	1 / 2 / 3 / 6	0718 101	51.00
0 - 20	0.1	50	1 - 5	0718 104	106.00
0 - 30	0.1	50	1 - 5	0718 105	120.00
0 - 50	0.1	50	1 - 5	0718 106	182.00
<b>With a lifting device and stand, range per revolution 10 mm</b>					
0 - 30	0.1	200	1 - 5	0718 108	156.00
0 - 30	0.1	300	1 - 5	0718 109	179.00
0 - 30	0.1	400	1 - 5	0718 110	200.00
<b>With a lifting wheel and concentric pointers, range per revolution 1 mm</b>					
0 - 10	0.01	18	1 / 2 / 3 / 6	0718 112	101.00
0 - 10	0.01	45	1 / 2 / 3 / 6	0718 113	116.00
<b>With a lifting device, range per revolution 1 mm</b>					
0 - 10	0.01	50	1 - 5	0718 115	120.00



0720 Dial thickness gauges

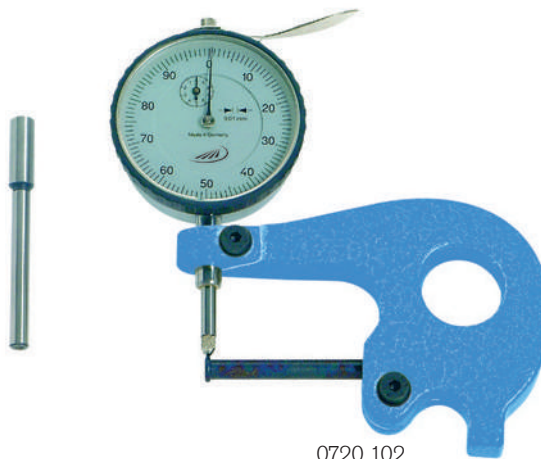

0720 102



0720 103

3

Model

- With a lifting device
- Factory standard
- Frame is made of alluminium alloy
- Revolution counter

- **Order No. 0720 102**  
Tube wall thickness dial gauge with 2 exchangeable probes  
- with bund radius = 10 mm, dia. 8 mm  
- cylindrical dia. 6 mm
- **Order No. 0720 103**  
Foil thickness measuring gauge, measuring insert dia. 6.35 mm, flat, thermally insulated

Delivery

- Cardboard box

☒	☒	Measuring range mm	Reading mm	Range per rev. mm	Throat depth mm	Order no.	List price EUR
<b>Tube wall thickness dial gauge</b>							
		0 - 10	0.01	1	50	0720 102	159.00
<b>Foil thickness dial gauge</b>							
		0 - 1	0.001	0.2	30	0720 103	227.00





## 0721 Internal caliper gauges



0721 120

### Model

- Protection class IP65

### Delivery

- Cardboard box

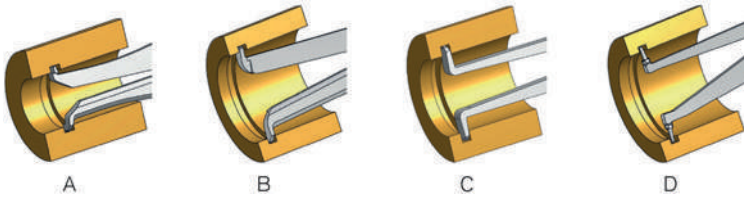

✕	🏠	Measuring range	Measuring depth	Reading	Error limit	For grooves		Order no.	List price EUR
		mm	mm			max. depth mm	min. width mm		
<b>Contact point type „A“, cutting (chisel) radius 0.1 mm</b>									
		2.5 - 12.5	12	0.005	0.015	0.7	0.6	0721 100	512.00
<b>Contact point type „B“, carbide ball Ø 0.6 mm</b>									
		5 - 15	35	0.005	0.015	2.2	0.8	0721 101	512.00
<b>Contact point type „B“, carbide ball Ø 1.0 mm</b>									
		10 - 30	85	0.01	0.03	5.2	1.2	0721 120	530.00
<b>Contact point type „C“, carbide ball Ø 1.0 mm</b>									
		20 - 40	85	0.01	0.03	7.0	1.2	0721 121	530.00
		30 - 50	85	0.01	0.03	7.0	1.2	0721 122	530.00
<b>Contact point type „D“, carbide ball Ø 1.0 mm</b>									
		40 - 60	85	0.01	0.03	8.3	1.2	0721 123	530.00
		50 - 70	85	0.01	0.03	8.3	1.2	0721 124	548.00
		60 - 80	85	0.01	0.03	8.3	1.2	0721 125	548.00
		70 - 90	85	0.01	0.03	8.3	1.2	0721 126	548.00
		80 - 100	85	0.01	0.03	8.3	1.2	0721 127	548.00



## 0721 External caliper gauges



0721 144

### Model

- Protection class IP65

### Delivery

- Cardboard box

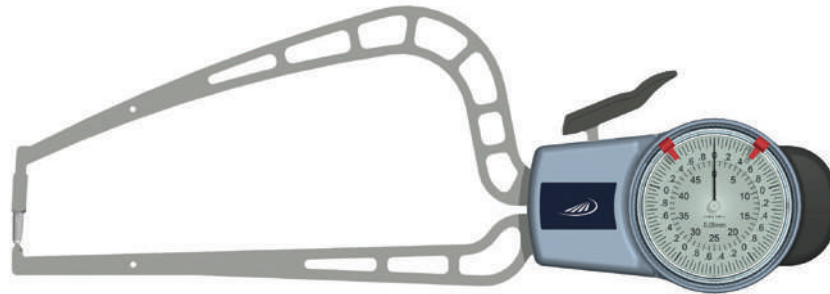

0721 149

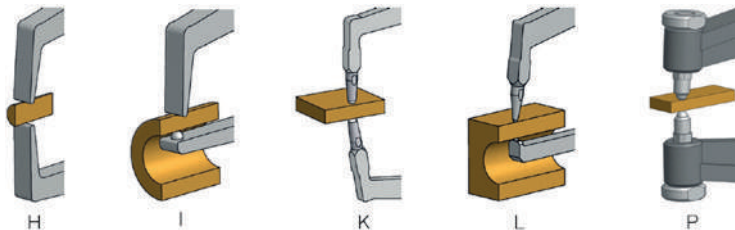

Icon	Measuring range	Measuring depth	Reading	Error limit	Contact point length		Order no.	List price
					moving mm	fixed mm		
	mm	mm	mm	mm				EUR
	<b>Contact point type „P“, carbide ball Ø 5.0 mm</b>							
	0 - 10	36	0.1	0.1	5	5	0721 140	145.00
	<b>Contact point type „H“, cutting (chisel) radius 0.4 mm</b>							
	0 - 10	35	0.005	0.015	18.8	18.8	0721 141	512.00
	<b>Contact point type „I“, fixed arm, carbide ball Ø 1.5 mm, moving arm, cutting (chisel) radius 0.4 mm</b>							
	0 - 10	35	0.005	0.015	18.8	0.9	0721 142	512.00
	<b>Contact point type „K“, carbide ball Ø 1.5 mm</b>							
	0 - 10	35	0.005	0.015	19.1	18.6	0721 143	512.00
	0 - 20	85	0.01	0.03	24.7	24.6	0721 144	512.00
	<b>Contact point „L“, carbide ball Ø 1.5 mm, 1 straight probe arm</b>							
	0 - 20	80	0.01	0.03	24.7	2.5	0721 145	512.00
	<b>Contact point type „K“, carbide ball Ø 3.0 mm</b>							
	0 - 50	167	0.05	0.05	30	30	0721 148	779.00
	<b>Contact point „L“, carbide ball Ø 3.0 mm, 1 straight probe arm</b>							
	0 - 50	169	0.05	0.05	30	4.3	0721 149	779.00



## 0721 Digital internal caliper gauges



0721 732

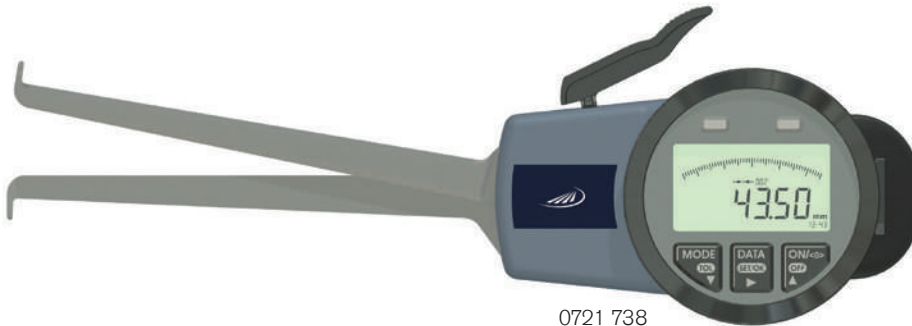

0721 738

### Model

- Protection class IP67

### Functions

- ON / OFF
- Set to zero at any point
- mm / inch switching
- PRESET-Function (setting a numerical value)
- TOL (tolerance value input)
- Data output

### Delivery

- Cardboard box

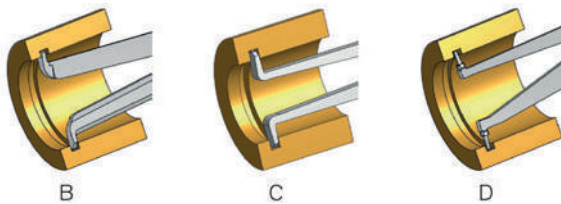

B

C

D

✕	☰	Measuring range	Measuring depth	Reading	Error limit	For grooves		Order no.	List price
		mm	mm			max. depth mm	min. width mm		
		<b>Contact point type „B“, carbide ball Ø 0.6 mm</b>							
		5 - 15	35	0.005	0.015	2.3	0.8	0721 731	548.00
		<b>Contact point type „C“, carbide ball Ø 1.0 mm</b>							
		10 - 30	85	0.01	0.03	5.2	1.2	0721 732	548.00
		20 - 40	85	0.01	0.03	7	1.2	0721 733	548.00
		30 - 50	85	0.01	0.03	7	1.2	0721 734	548.00
		<b>Contact point type „C“, carbide ball Ø 1.3 mm</b>							
		13 - 43	127	0.02	0.04	5.7	1.6	0721 738	698.00
		<b>Contact point type „D“, carbide ball Ø 2.0 mm</b>							
		50 - 80	132	0.02	0.04	8.3	2.4	0721 739	698.00
		<b>Contact point type „C“, carbide ball Ø 1.5 mm</b>							
		15 - 65	188	0.02	0.06	5.5	1.9	0721 740	964.00



0721 Digital external caliper gauges



0721 745

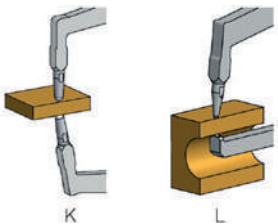

Functions

- ON / OFF
- Set to zero at any point
- mm / inch switching
- PRESET-Function (setting a numerical value)

- ABS (display can be set to zero without losing the Preset value)
- TOL (tolerance value input)
- Data output

Delivery

- Cardboard box

Icon	Measuring range	Measuring depth	Reading	Error limit	Contact point length mm		Order no.	List price
					moving	fixed		
	mm	mm	mm	mm				EUR
	<b>Contact point type „K“, carbide ball Ø 1.5 mm</b>							
	0 - 20	85	0.01	0.03	24.7	24.6	0721 741	548.00
	<b>Contact point type „K“, carbide ball Ø 3.0 mm</b>							
	0 - 30	116	0.02	0.04	30	30	0721 745	698.00
	0 - 50	167	0.02	0.06	30	30	0721 747	964.00
	<b>Contact point „L“ carbide ball Ø 3.0 mm, straight lower probe arm</b>							
	0 - 30	116	0.02	0.04	30	4	0721 746	698.00

0721 Accessories for caliper gauges



0721 785

Icon	Description	Order no.	List price
	Data interface (adapter and cable) for Digimatic*	0721 785	146.00
	Data interface (adapter and cable) for USB*	0721 786	146.00

When placing an order, please specify the order no. and the type of the caliper gauge.



## 0728 Internal precision bore gauges for large and deep bores



### Model

- 2 point comparator measuring instrument with split probe + measuring pin
- Centering plate
- Mounting hole Ø 8 mm
- Ideal in conjunction with dial gauges or dial comparator gauges

### Delivery

- Wooden case
- Without dial gauge

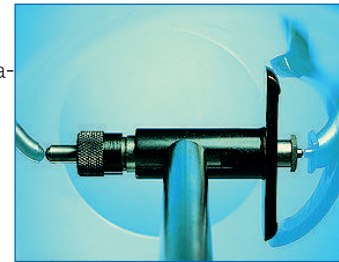

Measuring range	Repeatability	Measuring depth	Measuring pins	Measuring discs	Order no.	List price
<b>Fixed measuring pins, hardened special steel, interchangeable contact pins are carbide tipped</b>						
18 - 35	0.5	110	9	2	0728 105	395.00
35 - 60	0.5	138	7	2	0728 106	384.00
50 - 100	0.5	177	11	3	0728 107	439.00
100 - 160	0.5	234	7	4	0728 108	612.00
160 - 290	0.5	234	7	4	0728 109	883.00
280 - 510	1.5	400	7	4	0728 110	2084.00
<b>Fixed measuring pins and interchangeable contact pins, both pins are carbide tipped</b>						
4.5 - 6	0.5	80	9		0728 201	1007.00
6 - 8	0.5	100	7		0728 202	720.00
8 - 12	0.5	100	9		0728 203	671.00
12 - 20	0.5	110	9	1	0728 204	466.00
18 - 35	0.5	110	9	2	0728 205	471.00
35 - 60	0.5	138	7	2	0728 206	449.00
50 - 100	0.5	177	11	3	0728 207	525.00
100 - 160	0.5	234	7	4	0728 208	683.00
160 - 290	0.5	234	7	4	0728 209	904.00
280 - 510	1.5	400	7	4	0728 210	2133.00

## 0728 Setting device for internal precision bore gauges



### Model

- Setting device for accurate adjustment of internal precision bore gauges to the required nominal dimension, with gauge blocks
- The setting jaws are made of carbide and are lapped to gauge block quality
- Setting device can be used in both, the vertical and horizontal measuring axis

### Delivery

- Wooden case
- Incl. stand (excludes gauge blocks)

For measuring range	Error limit	Order no.	List price
4.5 - 160	2	0728 910	1245.00
18 - 290	2	0728 915	1234.00
160 - 510	2	0728 920	1786.00



0735 Crankshaft gauges

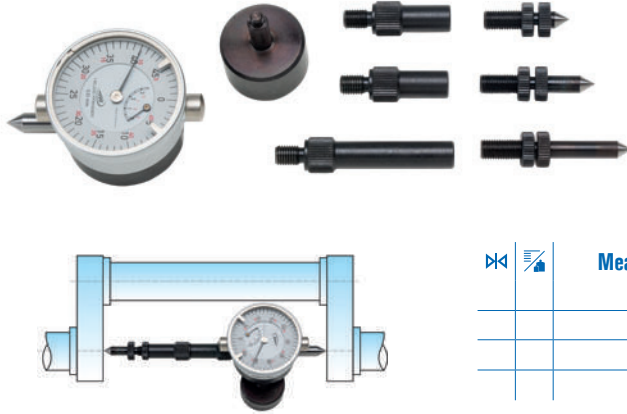

**Model**

- With dial gauge
- To be positioned between 2 crank arms
- Centre punch is not required
- Horizontal position of the dial gauge is assured with a plumb bob

**Delivery**

- Wooden case

Measuring range mm	Reading mm	Order no.	List price EUR
45 - 150	0.01	0735 101	408.00
60 - 300	0.01	0735 102	368.00
60 - 500	0.01	0735 103	427.00

0735 Replacement gauge for 0735

**Model**

- Without backplate

Order no.	List price EUR
<b>For measuring range 45 - 150 mm</b>	
0735 901	225.00
<b>For measuring range 60 - 300 / 60 - 500 mm</b>	
0735 902	187.00

0736 Length measuring instruments for external incisions

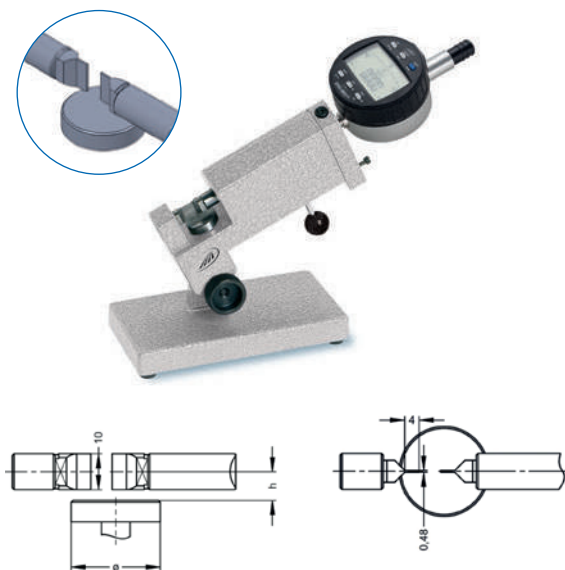

**Model**

- Ideal for serial measurements of incision diameters on turned parts
- Narrow measuring faces
- High precision ball guide of the transmission bolt
- Round support table, height adjustable, clamped for setting the exact measuring position
- Heavy stand
- Base unit in the angular grid 0° / 30° / 60° / 90°
- Titled and clamped
- Support for indicators with shaft Ø 8 mm
- Display devices: analogue and digital indicators

- Versions with other measuring inserts are available upon request

**Delivery**

- Cardboard box
- Without digital indicator (optional)

Measuring range mm	Size of table mm	Height h mm	Order no.	List price EUR
0 - 10	25	8	0736 101	942.00
0 - 25	38	13	0736 102	1016.00
25 - 50	50	35	0736 103	1088.00



## 0737 Length measuring instrument for internal incisions

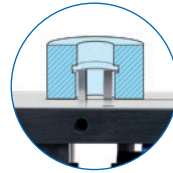

### Model

- Ideal for serial measurements of internal incision diameters
- High precision probe guidance with a constant measuring force
- Adjust the height with a gauge block
- Set the diameter with a setting ring
- Measuring table plate size 110 x 73 mm
- Mounting hole  $\varnothing$  8 mm
- Ideal for analogue and digital dial gauges as well as electronic probes
- Optional angled probes made of hardened steel

### Delivery

- Cardboard box
- Without indicator (optional)
- Without pair of measuring probes (optional)

	Measuring range internal mm	Size of table mm	Order no.	List price EUR
	4 - 56	110 x 73 mm	0737 101	917.00

## 0737 Measuring probes (pair) made of hardened steel for 0737

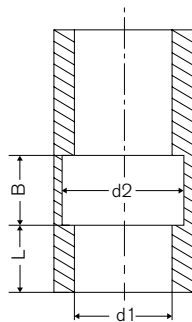

	For bore dia. „d1“ mm	Adjustable mess. height „L“ mm	Min. groove width „B“ mm	Max. incision dia. „d2“ mm	Order no.	List price EUR
	4 - 28	0 - 8	0.74	d1 + 2 mm	0737 121	91.00
	6.5 - 30	0 - 10	1.00	d1 + 4 mm	0737 122	91.00
	13 - 38	0 - 18	1.20	d1 + 2 mm	0737 123	91.00
	20.5 - 51	0 - 25	1.20	d1 + 4 mm	0737 124	91.00



## 0739 Universal comparator gauge

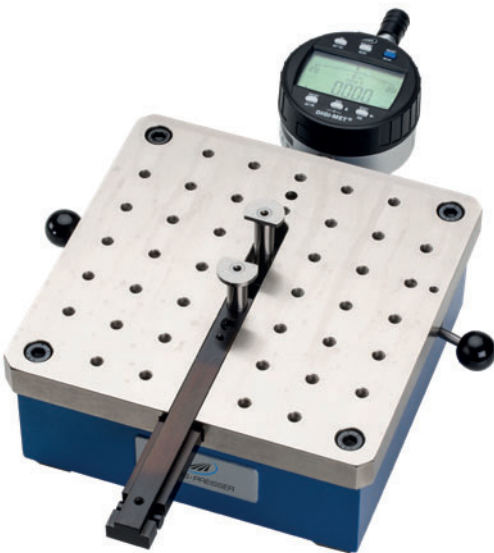

3



0739 124



0739 126

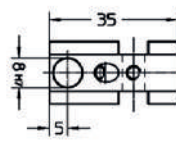

0739 164

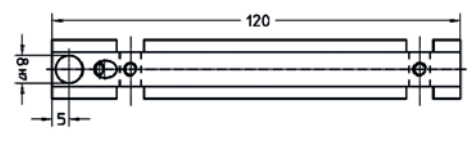

0739 165

### Model

- To determine internal and external diameters of recesses, grooves and undercuts in comparison measurement
- Measurement procedure: The part to be measured is determined at the point of reversal between a fixed and moveable measuring insert
- Select either an analogue or digital indicator to show your measuring results
- Sturdy construction
- Simple to set up and easy to operate
- Large range of application
- Ideal for serial measurements
- Optional: Special supporting table is interchangeable

- Repeatability: 2 µm
- Mounting hole for a dial gauge: Ø 8 mm

### Delivery

- Without digital indicator (optional)
- Incl. pair of measuring inserts 0739 126 and 0739 124
- Incl. holder for measuring inserts 0739 164 and 0739 165
- In a practical aluminium case

	Measuring range		Base dimensions	Order no.	List price
	external mm	internal mm	mm		EUR
	0 - 180	21 - 200	150 x 150 x 68	0739 102	1780.00





## 0739 Measuring probes

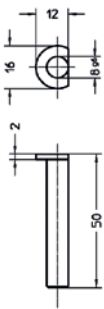

0739 124

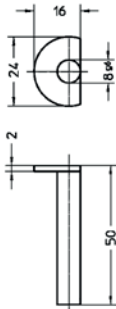

0739 125

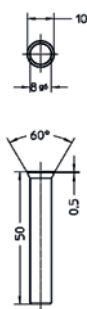

0739 126

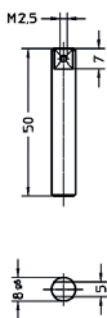

0739 127



0739 128

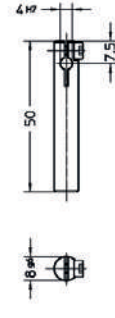

0739 129

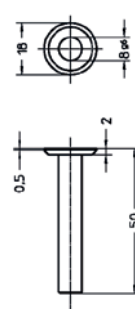

0739 130

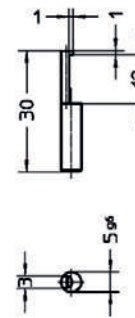

0739 131

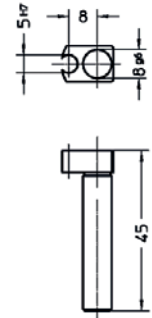

0739 132

	Description	Order no.	List price EUR
	Probe pair	0739 124	107.00
	Probe pair	0739 125	111.00
	Probe pair	0739 126	64.00
	Pair of probe holder	0739 127*	102.00
	Pair of probe holder	0739 128*	64.00
	Pair of probe holder	0739 129*	123.00
	Probe pair	0739 130	103.00
	Small probe pair	0739 131**	111.00
	Holder pair for 0739131	0739 132	148.00

\* For further information regarding probes order no. 0739 127 to 0739 129 see order no. 0710 starting on page 137

\*\* Required holder order no. 0739 132

### Application examples:

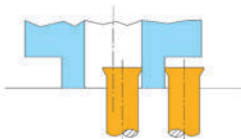

0739 126

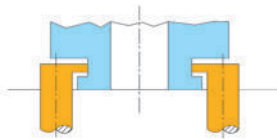

0739 124

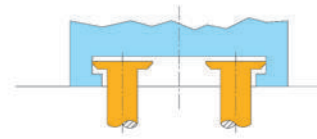

0739 130

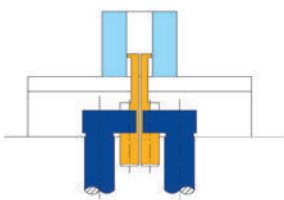

0739 131

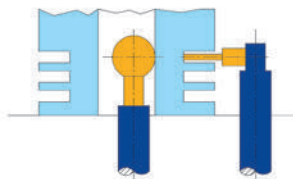

0739 127\*

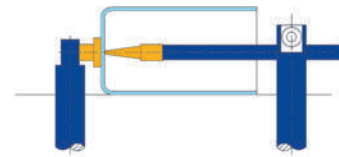

0739 129\*

0739 132

0739 128\*

0739 129\*



## 0739 Holder for measuring inserts short / long

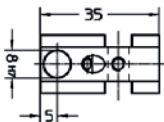

0739 164

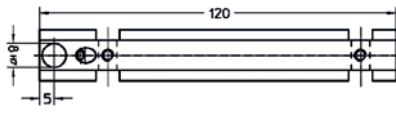

0739 165

Description	Length mm	Order no.	List price EUR
Holder, short	35	0739 164	38.60
Holder, long	120	0739 165	47.60

## 0739 Large supporting table

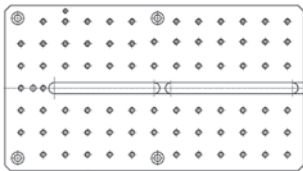

### Model

- Made of special steel with wear resistant surface coating
- Equipped with thread bore M5 in grid to attach stop elements
- Internal measurement: 21 - 220 mm
- External measurement: 0 - 300 mm

### Delivery

- With leg support to screw

Size of table mm	Order no.	List price EUR
269 x 149	0739 170	279.00

## 0739 Stop pieces

Description	Length mm	Width mm	Diameter mm	Dimensions h mm	Order no.	List price EUR
Stop cuboid	60	16		16	0739 121	91.00
Stop disc			24	16	0739 122	103.00
Stop stepped cuboid	60	25		16	0739 123	94.00

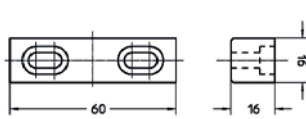

0739 121

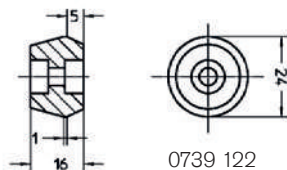

0739 122

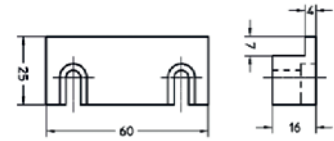

0739 123

### Application examples:

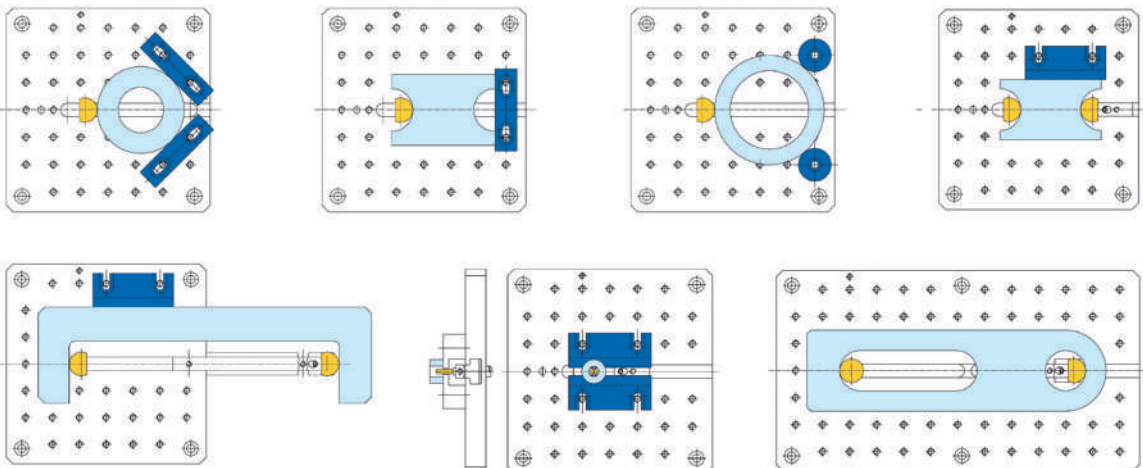



## 0741 Universal comparator gauge UHRTAST

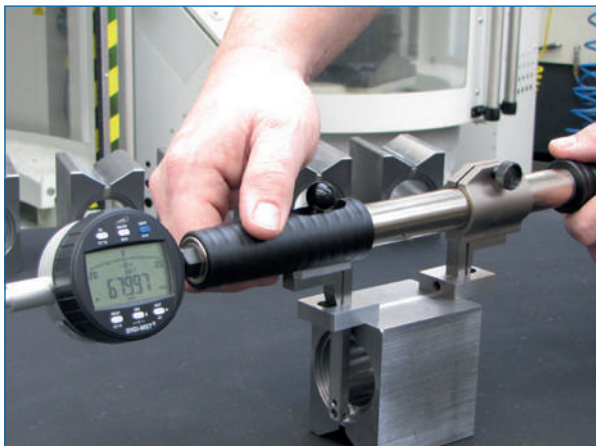
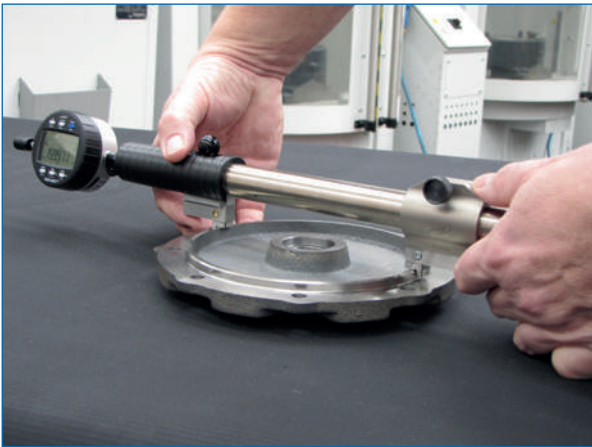



## 0741 Comparator gauge UHRTAST



### Model

- Comparator gauge for **external and internal measurements** for checking workpieces and setting of machines
- Versatile in use due to wide range of probes and inserts
- Measuring range up to 2000 mm by using optional extensions
- Without indicator
- The direction of the measuring force can be switched, the gauge can be used for external and internal measurements
- The adjustment can be conducted with a setting gauge, a combination of gauge blocks, setting ring or a micrometer
- The measuring range of the moveable measuring arm is 18 mm

### Delivery

- Wooden case
- Basic instrument without digital indicator, measuring arms and measuring probes (optional)



Product video

	Measuring range		Measuring forces N	Order no.	List price EUR
	external mm	internal mm			
	5 - 220	15 - 230	external: ~6 N internal: ~4 N	0741 101	1862.00

## 0741 Pair of probe mounting block

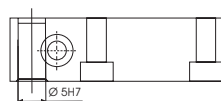

	Order no.	List price EUR
	0741 170	171.00

## 0741 Extensions



### Model

- Combinable with the basic instrument and further extensions by sticking together the pipe construction



0741 112



0741 114

	Length mm	Order no.	List price EUR
	100	0741 112	259.00
	200	0741 114	275.00
	500	0741 116	420.00



## 0741 Measuring inserts



0741 178

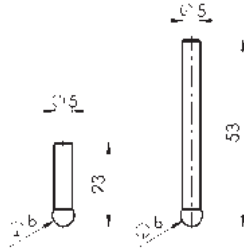

	Length mm	Diameter mm	Order no.	List price
				EUR
	23	6	0741 178	115.00
	53	6	0741 179	115.00

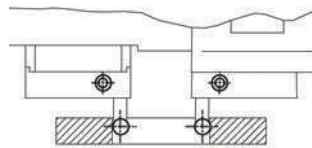

## 0741 Measuring inserts

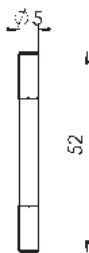

	Length mm	Diameter mm	Order no.	List price
				EUR
	52	5	0741 180	115.00

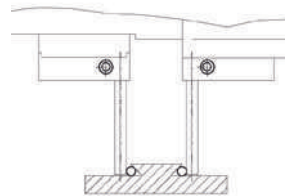

## 0741 Pair of offset measuring inserts

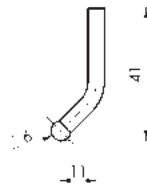

	Length mm	Diameter mm	Order no.	List price
				EUR
	41	6	0741 182	191.00

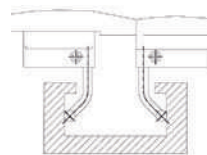

## 0741 Pair of measuring inserts with discs

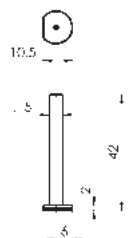

	Length mm	Width mm	Diameter mm	Dimensions h mm	Order no.	List price
						EUR
	42	10.5	12	2	0741 176	115.00

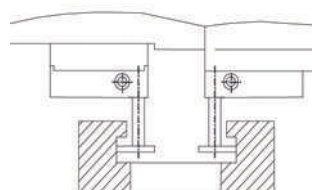



## 0741 Measuring inserts

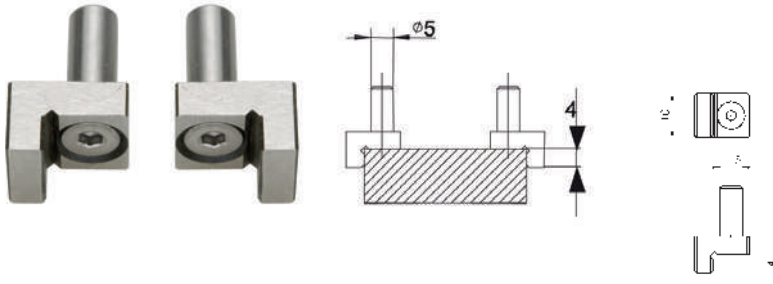

### Model

- For measuring external central points

	Order no.	List price EUR
	0741 172	204.00

## 0741 Pair of shoulder measuring inserts

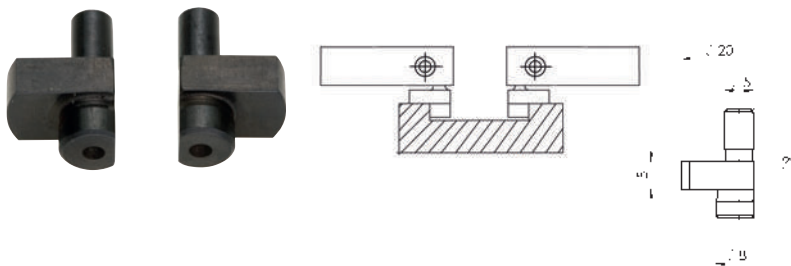

### Model

- For measuring internal central points

	Order no.	List price EUR
	0741 174	167.00

## 0741 Pairs of thread measuring inserts for metric external thread

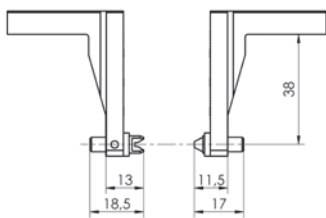

### Model

- Thread measuring inserts for external thread, metric pitch, in pairs

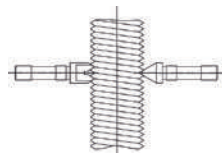

	Thread pitch mm	Order no.	List price EUR
	0.35	0741 140	192.00
	0.4 - 0.45	0741 141	108.00
	0.5 - 0.6	0741 142	108.00
	0.7 - 0.8	0741 143	108.00
	1.0 - 1.25	0741 144	108.00
	1.5 - 1.75	0741 145	108.00
	2.0 - 2.5	0741 146	108.00
	3.0 - 3.5	0741 147	108.00
	4.0 - 5.0	0741 148	108.00
	5.5 - 6.0	0741 149	108.00

## 0741 Pairs of thread measuring inserts for metric internal thread

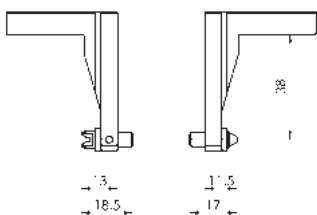

### Model

- Thread measuring inserts for internal thread, metric pitch, in pairs

	Thread pitch mm	Order no.	List price EUR
	1.0 - 1.25	0741 163	219.00
	1.5 - 1.75	0741 164	219.00
	2.0 - 2.5	0741 165	219.00
	3.0 - 3.5	0741 166	219.00
	4.0 - 5.0	0741 167	219.00
	5.5 - 6.0	0741 168	219.00



## 0741 Pairs of measuring arms

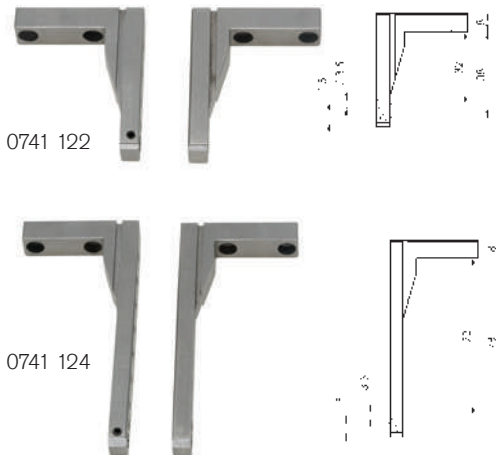

### Model

- For mounting of adapter pieces and inserts with shaft- $\varnothing$  3.5 mm and  $\varnothing$  5 mm
- With lasered help rule (mm-divide) as position help for the depth stop pieces

	Length mm	Order no.	List price EUR
	40	0741 122	270.00
	80	0741 124	324.00

## 0741 Pair of depth stop attachment for measuring arms



### Model

- To slide on measuring arms
- Can be clamped with grub screw

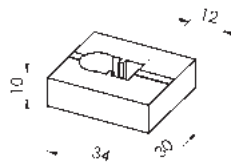

	Length mm	Width mm	Height mm	Order no.	List price EUR
	34	30	10	0741 136	251.00

## 0741 Pair of adapters 5 mm for measuring inserts M2.5

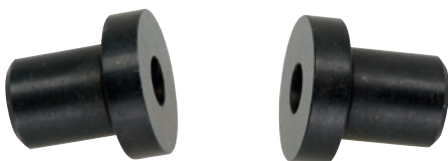

### Model

- All measuring inserts for dial gauges with M2.5 can be used (measuring inserts please refer to pages 137-140)

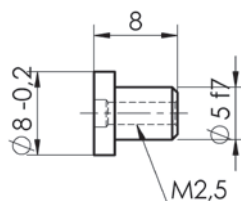

	Order no.	List price EUR
	0741 132	88.00



## 0741 Pair of adapters for thread measuring inserts (pair)

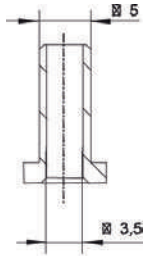

### Model

- Pair of adapters for thread measuring inserts with long shanks (length 13.5 mm)  
Adapters are not required for measuring inserts with short shanks

Order no.	List price EUR
0741 134	152.00

## 0741 Measuring table



### Model

- Consisting of:  
Supporting table  $\varnothing$  180 mm  
Measuring probe  
Mounting stands

### Delivery

- Cardboard box

Size of table mm	Order no.	List price EUR
$\varnothing$ 180	0741 184	649.00





## 0753 Universal indicator stands with magnetic base



0753 110



0753 120

### Model

- Chrome finished columns
- Base with V-groove
- Magnet with ON/OFF switch
- Mounting clamp: Ø 8 mm for indicators
- Integrated fine adjustment

### Delivery

- Cardboard box

✕	🏠	Projection	Column height	Column dia.	Arm dia.	Base dimensions	Magnetic force	Order no.	List price
		mm	mm	mm	mm	mm	N		EUR
		140	230	16	12	60 x 50 x 55	500	0753 110	24.90
		180	285	16	16	70 x 46 x 65	600	0753 120	61.00



## 0750 Universal indicator stands with magnetic base and combi clamp



0750 101

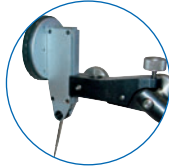

### Model

- Chrome plated columns
- Base with V-groove
- Magnet with ON/OFF switch
- **Combi clamp:** Ø 8 mm for dial gauges, swallow tail clamp for dial test indicators
- Intergrated fine adjustment

### Delivery

- Cardboard box

### Accessories

Replacement crosshead complete  
Wooden case for magnet - measuring support

Order no.	List price EUR
0750 113	42.00
0750 601	25.10

Projection mm	Column height mm	Column dia. mm	Arm dia. mm	Base dimensions mm	Magnetic force N	Order no.	List price EUR
<b>Crosshead clamp</b>							
180	285	16	16	70 x 46 x 65	600	0750 101	140.00
180	500	20	16	75 x 60 x 102	800	0750 102	187.00

## 0750 Pillar with transverse arm and fine adjustment



### Model

- Chrome plated column and transverse arm
- Mounting for indicator:
  - shank mounting Ø 8 mm for dial gauges
  - swallow tail clamp for dial test indicators
- Integrated fine adjustment

Thread	Projection mm	Column height mm	Column dia. mm	Arm dia. mm	Description	Order no.	List price EUR
M10	180	285	16	16	for 0750 101	0750 121	85.00
M12	180	500	20	16	for 0750 102	0750 122	96.00

## 0750 Magnetic base



0750 111

### Model

- Magnetic base with V-groove
- Cling to flat and cylindric parts
- Magnetic force can be switched On / Off by rotary switch

Thread	Base dimensions mm	Magnetic force N	Order no.	List price EUR
M10	70 x 46 x 65	600	0750 111	59.00
M12	75 x 60 x 80	800	0750 112	109.00



## 0751 Magnetic indicator stands with flexible arm



0751 103



0751 104

### Model

#### ▪ 0751 103:

- with flexible arm
- holding force by rope tension on hinge segments
- switch magnetic base

#### ▪ 0751 104:

- fixed column
- with fine adjustment
- flexible transverse arm
- switch magnetic base

### Delivery

- Cardboard box

☒ ☒	Column height mm	Column dia. mm	Base dimensions mm	Magnetic force N	Order no.	List price EUR
<b>Heavy duty stand</b>						
	350	-	70 x 45 x 65	600	0751 103	118.00
<b>Clamping via the star knob screw</b>						
	350	16	70 x 45 x 65	600	0751 104	138.00

## 0754 Universal magnetic holder



### Model

- Magnetic base with V-groove
- With mounting hole Ø 8 mm
- Three-sided magnet

### Delivery

- Cardboard box

☒ ☒	Max. height mm	Base dimensions mm	Magnetic force N	Order no.	List price EUR
	57	70 x 35	260	0754 101	99.00



## 0752 Magnetic indicator stands with central lock



0752 101



0752 103

### Model

- Column / Arm:
  - 0752 101 steel, chrome finished
  - 0752 103 aluminium, anodized
- Switch magnetic base with V-groove
- Central magnetic clamping system

- **Combi clamp:** Ø 8 mm for dial gauges, swallow tail clamp for dial test indicators
- Intergrated fine adjustment

### Delivery

- Cardboard box

Projection	Column height	Column dia.	Base dimensions	Magnetic force	Order no.	List price
mm	mm	mm	mm	N		EUR
260	310	10	70 x 46 x 65	600	0752 101	144.00
320	370	18	70 x 46 x 65	600	0752 103	184.00

## 0756 Universal magnetic holder



### Model

- Cast iron base with two magnets on the bottom of the holder
- With mounting hole Ø 8 mm

### Delivery

- Cardboard box

Max. height	Base dimensions	Magnetic force	Order no.	List price
mm	mm	N		EUR
45	72 x 37	180	0756 101	59.00



## 0770 Compact measuring stands



0770 102



0770 103



0770 201

### Model

- Cast base
- Chrome finished columns
- Hardened steel table

- With dust grooves (Order No. 0770 102 non-stop plane)
- With mounting hole for dial gauges  $\varnothing$  8 mm

### Delivery

- Cardboard box

Marked *	Marked *	Measuring height mm	Projection mm	Size of table mm	Column dia. mm	Arm dia. mm	Order no.	List price EUR
<b>With fixed arm</b>								
		100	49	$\varnothing$ 50	22	-	0770 102	176.00
		100	49	60 x 68	22	-	0770 103	223.00
<b>With adjustable transverse arm</b>								
		100	100	60 x 68	22	18	0770 201	225.00
		150	135	98 x 115	28	20	0770 205	349.00



## 0772 Measuring stand



### Model

- Cast base
- Hardened steel table
- With dust grooves
- With a threaded column and an adjustable transverse arm
- With mounting hole for dial gauges Ø 8 mm

### Delivery

- Cardboard box

☒	☒	Measuring height	Projection	Size of table	Column dia.	Arm dia.	Order no.	List price
		mm	mm	mm	mm	mm		EUR
		160	200	170 x 215	35	22	0772 024	759.00

## 0785 Precision measuring stands



### Model

- Base made of hard stone
- Base plate accuracy according to DIN 876-00
- With a threaded column
- With adjustable transverse arm
- With mounting hole for dial gauges Ø 8 mm
- Vertical adjustment by threaded spindle with setting ring

### Delivery

- Cardboard box

☒	☒	Measuring height	Projection	Size of table	Column dia.	Arm dia.	Order no.	List price
		mm	mm	mm	mm	mm		EUR
		200	200	150 x 260	35	22	0785 108	639.00
	▪	220	220	300 x 350	35	22	0785 109	1565.00
		<b>Anti-twist (secured against rotation) transverse arm</b>						
	▪	220	220	300 x 350	35	22	0785 110	1800.00



## 0763 Universal measuring support



### Model

- Column and transverse arm chrome plated
- Column is moving and can be clamped in the T-groove
- Heavy base plate with prismatic base and T-groove
- Mounting for display devices:
  - support for indicators with shaft  $\varnothing$  8 mm, swallow tail clamp for dial test indicators
- Integrated fine adjustment

### Delivery

- Cardboard box

	Projection	Column height	Column dia.	Arm dia.	Base dimensions	Order no.	List price
	mm	mm	mm	mm	mm		EUR
	180	300	16	16	250 x 60 x 35	0763 100	279.00



## 0780 Bench centres

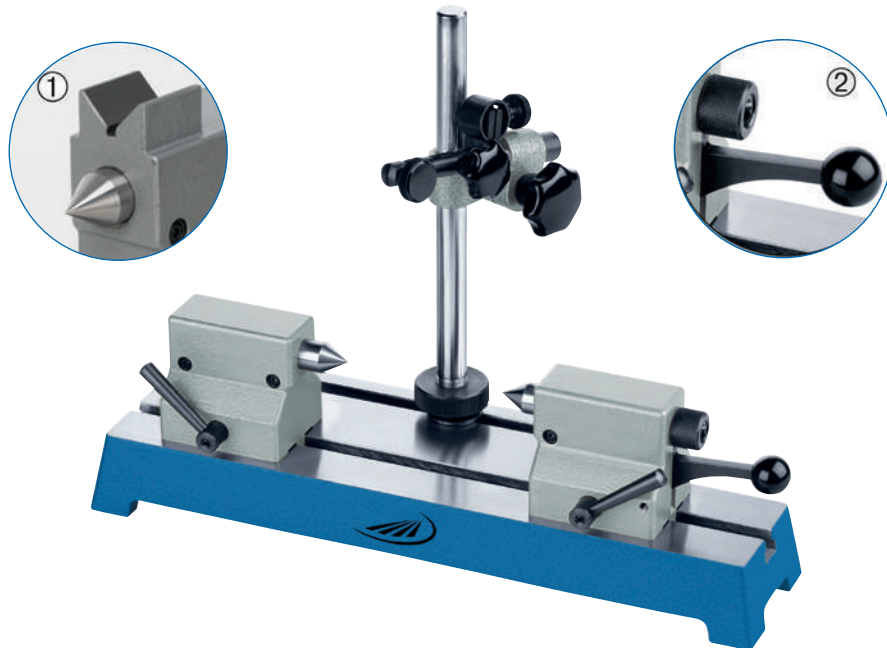

3

### Model

- Finely ground surface, flatness tolerance according to DIN 876-2
- With two adjustable tailstocks
- Left tailstock with fixed centre
- Right tailstock with retractable spring mounted centre, free lift appr. 10 mm

### Delivery

- Tailstocks can be clamped via an eccentric clamp
  - Tailstock height 75 mm with integrated V-groove support
  - Quick-clamping device by clamping lever
  - With T-groove and support column
  - With mounting hole for dial gauges  $\varnothing$  8 mm
- Cardboard box

▶	☒	Height of centers	Workpiece load	Distance between centres	Center dia.	T-groove width	Base	Order no.	List price
		mm	p. tailstock max. kg	mm	mm	mm	mm		EUR
		50	5	200	16	10H7	350 x 110	0780 101	605.00
		50	5	350	16	10H7	500 x 110	0780 102	768.00
		75	5	200	16	10H7	350 x 110	0780 104*	692.00
		75	5	350	16	10H7	500 x 110	0780 105*	788.00
	▪	100	20	450	22	12H7	700 x 180	0780 107	1984.00
	▪	150	20	450	22	12H7	700 x 180	0780 108	2212.00

\* With integrated V-groove support on the tailstocks for  $\varnothing$  6 - 24 mm

### Accessories

	Order no.	List price EUR
Replacement centre, retractable, $\varnothing$ 16 mm (50 - 75 mm)	0780 174	49.00
Replacement centre, fixed, $\varnothing$ 16 mm (50 - 75 mm)	0780 175	39.00
Replacement centre, retractable, $\varnothing$ 22 mm (100 - 150 mm)	0780 177	125.00
Replacement centre, fixed, $\varnothing$ 22 mm (100 - 150 mm)	0780 178	115.00





## 0780 Bench centres with roller supports



### Specification

- Finely ground surface, flatness tolerance according to DIN 876-2
- With two roller supports
- Concentricity tolerance of the rolls 0.005 mm
- Quick-clamping device by clamping lever
- With T-groove and support column
- With mounting hole for dial gauges  $\varnothing$  8 mm
- Fine adjustment

### Delivery

- Cardboard box

✕	📏	Height of roller supports	T-groove width	Base	Contact surface	Order no.	List price
		mm	mm	mm	mm		EUR
		65	10H7	350 x 110	3 - 30	0780 201	559.00
		65	10H7	500 x 110	3 - 30	0780 202	699.00
		100	12H7	700 x 180	4 - 60	0780 206	1400.00



0780 Bench centres with V-groove supports



3

Specification

- Finely ground surface, flatness tolerance according to DIN 876-2
- With two V-supports
- Quick-clamping device by clamping lever
- Prismatic contact surface 90°
- V-groove surfaces made of hardened steel (replaceable)
- With T-groove and support column
- With mounting hole for dial gauges Ø 8 mm
- Fine adjustment

Delivery

- Cardboard box

Icon	Height of V-supports	T-groove width	Base	Contact surface	Order no.	List price
	mm	mm	mm	mm		EUR
	65	10H7	350 x 110	5 - 25	0780 301	529.00
	65	10H7	500 x 110	5 - 25	0780 302	669.00
	100	10H7	700 x 180	5 - 50	0780 306	1340.00



## 0780 Bench centres for heavy workpieces



### Model

- Finely ground surface, flatness tolerance according to DIN 876-2
- With two adjustable tailstocks
- Left tailstock with fixed centre
- Right heavy tailstock with moveable, spring mounted centre, free lift appr. 10 mm
- Tighten by hand crank
- Tailstock can be clamped via an eccentric clamp
- Base made of cast iron with T-groove
- Measuring stand with mounting hole for dial gauges Ø 8 mm

### Delivery

- Cardboard box

✕	☒	Height of centers	Workpiece load	Distance between centres	Centering tip dia.	T-groove width	Base	Order no.	List price
		mm	p. tailstock max. kg	mm	mm	mm	mm		EUR
	▪	100	40	450	22	12	700 x 180	0780 141	2116.00
	▪	150	40	450	22	12	700 x 180	0780 142	2395.00

## 0780 Pair of v-support inserts



### Model

- V-support inserts to place in and for testing of shafts without centrebores
- V-support inserts are exchanged for the pointed alignment centre of the tailstocks



✕	☒	For height of centers	Max. workpiece dia.	Contact surface	Order no.	List price
		mm	mm	mm		EUR
		50/75	15	3 - 15	0780 021	88.00
		100	45	8 - 45	0780 023	133.00

## 0780 Replacement support column



### Model

- Column is moving and can be clamped in the T-groove
- Mounting for indicator:
  - shaft mounting Ø 8 mm for dial test indicators
- Integrated fine adjustment



✕	☒	For height of centers	Projection	T-groove width	Column height	Column dia.	Arm dia.	Order no.	List price
		mm	mm		mm	mm	mm		EUR
		50/75	105	10	200	18	14	0780 072	105.00
		100	105	12	240	18	14	0780 073	184.00
		150	105	12	440	18	14	0780 074	212.00



## 0780 Left tailstocks with a rotating collet chuck



### Model

- The left tailstock can be changed because of this specification with a collet chuck
- The collet chuck is rotatable for runout testing
- T-grooves bearing
- Eccentric clamp

Height of centers mm	T-groove width mm	Order no.	List price EUR
<b>For collet chucks type F10 (Ø 1 - 7 mm)</b>			
50	10	0780 001	376.00
75	10	0780 002	417.00
<b>For collet chucks type F14 (Ø 1 - 10 mm)</b>			
100	12	0780 003	649.00

- Collet chucks F10 from 1-7 mm are available upon request
- Collet chucks F14 from 1-10 mm are available upon request

## Pair of replacement tailstocks for 0780

### Model

- Included in base model 0780
- 75 mm with intergrated V-groove support
- For heavy workpieces with load up to 40 kg on request

Height of centers mm	Workpiece load p. tailstock max. kg	T-groove width mm	Order no.	List price EUR
50	5	10	0780 091	380.00
75	5	10	0780 092	427.00
100	20	12	0780 093	879.00
150	20	12	0780 094	909.00

## Pair of V-groove supports for 0780



### Model

- For workpieces without centering
- Functional test through applying on e.g. plain lateral surface
- Recognition of form errors
- For exchange of centre supports
- Prismatic contact surface 90°
- V-groove surfaces made of hardened steel (replaceable)
- T-grooves bearing
- Eccentric clamp

Height of centers* mm	Height of V-supports mm	T-groove width mm	Contact surface mm	Order no.	List price EUR
65	65	10	5 - 25	0780 032	162.00
100	100	12	5 - 50	0780 033	231.00

\* based on the center of an axis of a shaft Ø 10 mm

## Pair of roller supports for 0780



### Model

- For exchange of centre supports
- Ball bearing rollers for easy turning of the workpieces
- Concentricity tolerance 0.005 mm

Height of roller supports* mm	T-groove width mm	Contact surface mm	Order no.	List price EUR
65	10	3 - 30	0780 042	193.00
100	12	4 - 60	0780 043	261.00

\* based on the center of an axis of a shaft Ø 10 mm



## 0783 Bench centre



DIN  
876-1



### Model

- Dark granite work bench
- Flatness tolerance in accordance to DIN 876-1
- Right tailstock with retractable spring mounted centre (quick adjustment lever)
- Left tailstock with fixed centre
- Tailstocks can be adjusted via an eccentric clamp

### Delivery

- Wooden handling case
- Included:
  - Work bench
  - Support post
  - 1 pair of tailstocks with pointed alignment centre 60° MK 2

⌘	▢	Height of centers mm	Workpiece load p. tailstock max. kg	Distance between centres mm	T-groove width mm	Base mm	Order no.	List price EUR
▪		200	24	650	14	1100 x 180	0783 012	3545.00

Accessories	Order no.	List price EUR
Pair of pointed alignment centres	0782 181	225.00
Tailstock	0782 191	1172.00
Measuring support	0783 070	296.00

## 0782 Pair of roller supports



### Model

- For exchange of centre supports
- Ball bearing rollers for easy turning of the workpieces
- T-grooves bearing
- Eccentric clamp

⌘	▢	Height of roller supports mm	T-groove width mm	Contact surface mm	Order no.	List price EUR
		200	14	25 - 100	0782 160	706.00



## 0784 Concentricity measuring gauge with disc supports

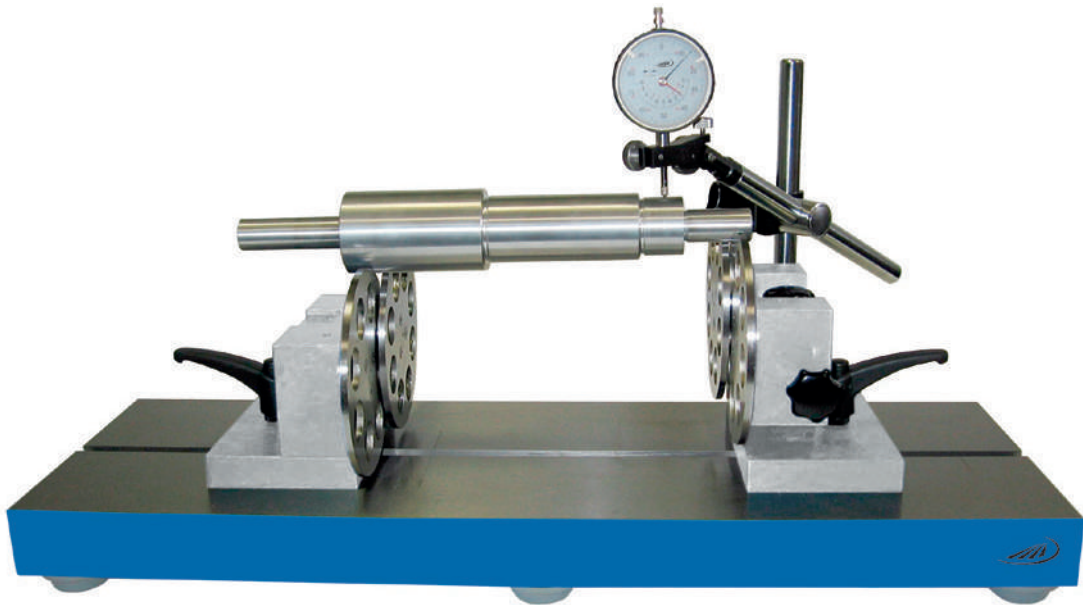

3

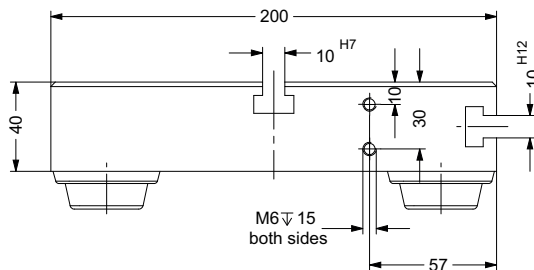

### Model

- Centerless concentricity measuring instrument
- High accuracy discs are being mounted on bearings; free of play
- Discs can be slid to either side on the base

### Delivery

- One sliding disc can be adjusted up to 30 mm for diametral compensation
- Concentricity accuracy < 5 μm
- Wooden case
- Includes the support stand, excludes a dial gauge

Workpiece load p. tailstock max. kg	Distance between the end mm	Disc diameter mm	Max. workpiece dia. mm	Order no.	List price EUR
25	400	120	250	0784 108	3101.00

### Accessories

Accessories	Order no.	List price EUR
Replacement discs, pair, Ø 120 mm	0784 181	625.00
Complete support stand for order no. 0784 108	0784 190	175.00



## 0788 Shaft measuring instrument



### Model

- For rapid measurement of diameters, distances, shoulders, taper, roundness, etc.
- For vertical and horizontal alignment
- Vertical base with 3 hardened adjustment support surfaces
- Measuring beam is made of stainless steel
- Load capacity horizontal max. 20 kg

### Delivery

- Cardboard box
- Without measuring support, guideway, dial gauge (optional accessories)

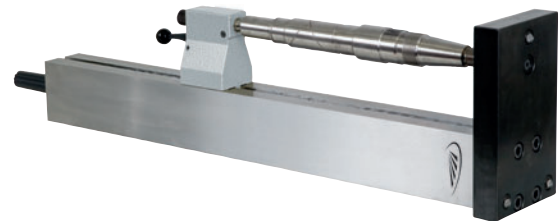

application as a bench centre

✕	📄	Height of centers	Distance between centres	T-groove width	Base	Order no.	List price
		mm	mm	mm	mm		EUR
▪		75	550	10 H7	200 x 120	0788 104	1131.00
<b>Accessories</b>						<b>Order no.</b>	<b>List price</b>
Support arm with guideways						0788 180	229.00



0788 180



## 0788 Shaft measuring instrument lightweight



### Model

- For rapid measurement of distances, shoulders, taper, roundness, etc.
- Vertical and horizontal alignment
- Vertical base with 3 hardened adjustment support surfaces
- Measuring beam is made of hard anodized aluminium profile
- Aluminium tailstocks
- Load capacity horizontal max. 15 kg

### Delivery

- Cardboard box
- Without measuring support, guideway, dial gauge (optional accessories)



application as a bench centre

3

	Height of centers	Distance between the end	T-groove width	Base	Order no.	List price	
	mm	mm	mm	mm		EUR	
	75	550	10 H7	200 x 150	0788 904	900.00	
<b>Accessories</b>						<b>Order no.</b>	<b>List price</b>
						<b>EUR</b>	
Support arm with holder					0788 980	73.00	
Support arm with guideways					0788 990	326.00	



0788 980



0788 990





# SAMPLES MARKING GAUGES

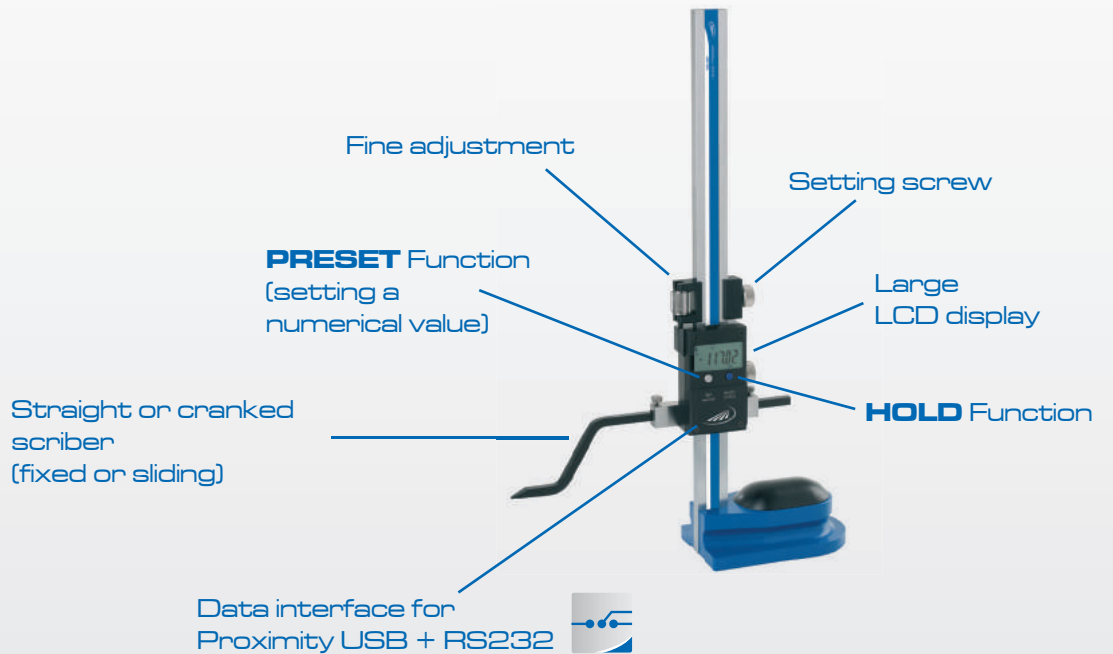
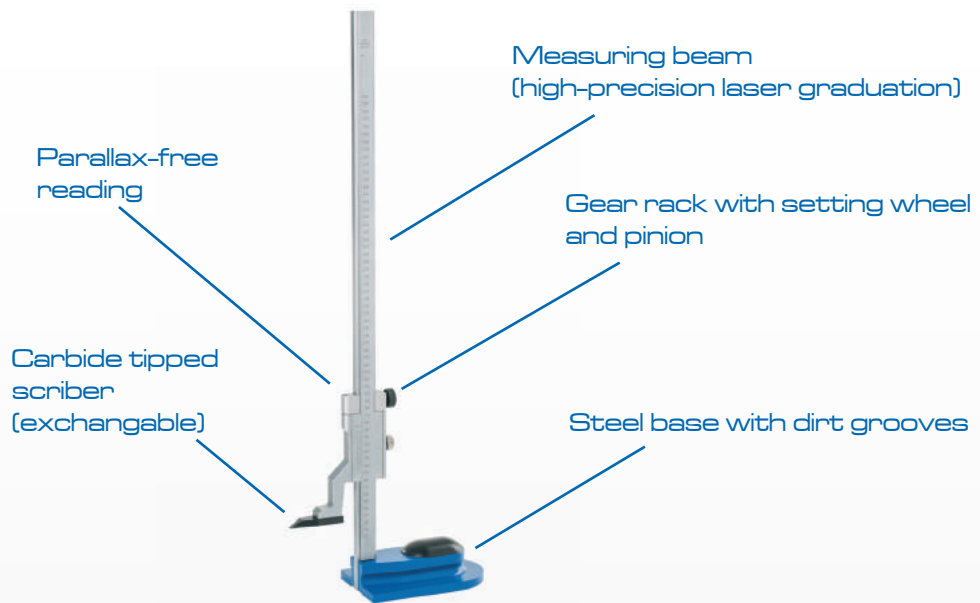

More products from our range of **Marking gauges**



MARKING**GAUGES**



**DIVIDERS**

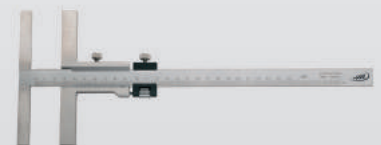

MARKING**CALIPERS**

## 4. CHAPTER MARKING GAUGES

178	Scribers
179	Dividers
181	Beam compass
183	Internal and external calipers
186	Marking calipers / Marking gauges
190	Height and scribing gauges

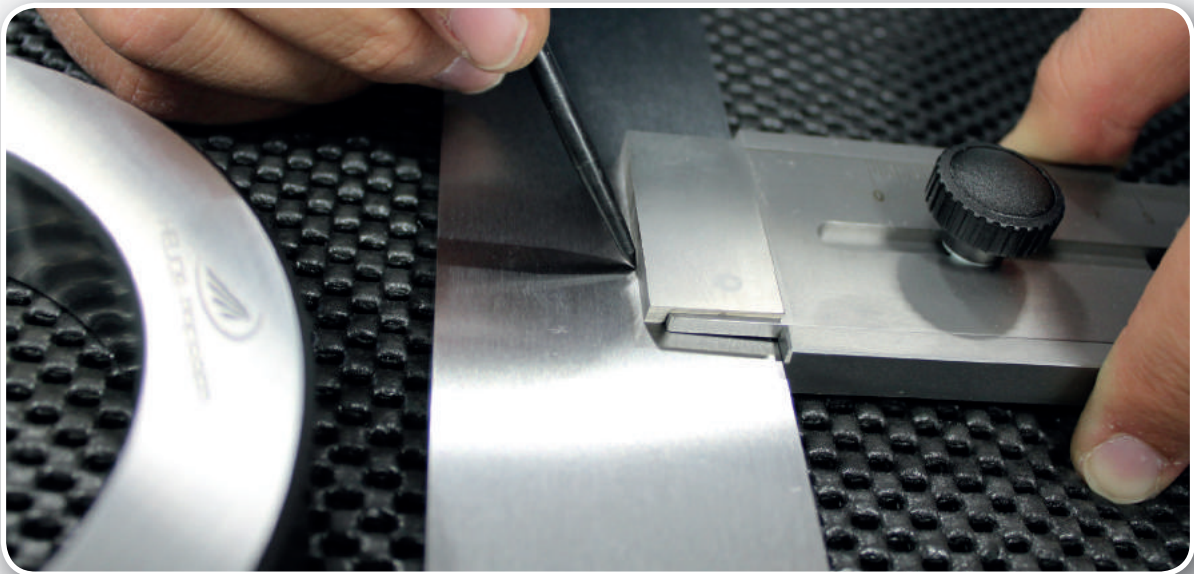



## 0300 Scribes



✂	🏠	Length mm	Material	Order no.	List price EUR
<b>With straight screw-in scribe</b>					
		175	Chromium-vanadium steel, hardened	0300 007	2.10
		175	Carbide-tipped	0300 103	10.30
<b>With one straight and one L-shaped screw-in scribe</b>					
		250	Chromium-vanadium steel, hardened	0300 008	2.30
<b>With one straight and one angled screw-in and burnished scribe</b>					
		200	Chromium-vanadium steel, hardened	0300 011	2.10
		250	Carbide-tipped	0300 114	8.80
<b>With a mechanic and pocket clip</b>					
		150	Carbide-tipped	0300 120	12.80
<b>One piece hexagonal body with a pocket clip</b>					
		180	Carbide-tipped	0300 102	5.60
<b>With straight scribe, plastic handle, ball point pen form, incl. 20 interchangeable marking scribes</b>					
		125	Chromium-vanadium steel, hardened	0300 013	10.20
<b>For scribe 0300 008, with straight scribe, plastic handle</b>					
		110	Carbide-tipped	0300 112	4.70

## 0300 Replacement scribes



✂	🏠	Length mm	Material	Order no.	List price EUR
<b>For scribes 0300 007, 0300 008, straight</b>					
		86	Chromium-vanadium steel, hardened	0300 009	1.10
<b>For scribe 0300 008, L-shaped</b>					
		80	Chromium-vanadium steel, hardened	0300 010	1.10
<b>For scribe 0300 013: (Package = 50 pieces), straight</b>					
		16	Chromium-vanadium steel, hardened	0300 014	3.50
<b>For scribe 0300 120</b>					
		33	Carbide-tipped	0300 130	3.40



## 0301 Precision dividers



### Model

- With a rivetted hinge
- Hardened needle, shaped ground points
- Special steel

### Delivery

- Cardboard box

✂	☒	Length mm	Order no.	List price EUR
		150	0301 001	7.30
		175	0301 002	8.30
		200	0301 003	9.20
		250	0301 004	12.80
		300	0301 005	15.50
		400	0301 006	41.90
		500	0301 007	59.00
		600	0301 008	78.00
		800	0301 009	109.00
		1000	0301 010	160.00

## 0302 / 0306 Dividers with quadrant



### Model

- With a rivetted hinge
- Special steel
- Quadrant with robust, milled locking screw
- Hardened points

### Delivery

- Cardboard box

✂	☒	Length mm	Order no.	List price EUR
		150	0302 001	10.70
		175	0302 002	11.80
		200	0302 003	12.60
		250	0302 004	16.50
		300	0302 005	21.60
		400	0302 006	60.00
		500	0302 007	74.00
		600	0302 008	95.00
		800	0302 009	132.00
		1000	0302 010	183.00
<b>With pencil holder</b>				
		150	0306 001	13.70
		200	0306 003	15.50
		300	0306 005	24.20



## 0310 Spring dividers



### Model

- Quick release set screw
- Special steel
- Fixed points
- Hardened points
- Quick release set screw and spring are burnished

### Delivery

- Cardboard box

▶▶	🏠	Radius mm	Order no.	List price EUR
		90	0310 101	3.60
		115	0310 102	4.00
		140	0310 103	4.40
		190	0310 105	4.90
		240	0310 107	6.30
		290	0310 108	7.40

## 0311 Spring dividers



### Model

- Quick release set screw
- Special steel
- Interchangeable points
- Hardened points
- Quick release set screw and spring are burnished

### Delivery

- Cardboard box

▶▶	🏠	Radius mm	Order no.	List price EUR
		90	0311 101	3.60
		115	0311 102	4.20
		140	0311 103	4.90
		190	0311 105	5.80
		240	0311 107	7.10
		290	0311 108	7.60

## 0311 Pair of replacement points for spring dividers



▶▶	🏠	Material	Order no.	List price EUR
		Special steel, hardened	0311 120	2.30
		Carbide-tipped	0311 121	19.10
<b>Set of 10 replacement points</b>				
		Special steel, hardened	0311 124	19.50



## 0316 Beam trammel



### Model

- With interchangeable steel points
- Stainless steel
- Locking screw
- Fine adjustment
- Factory standard

### Delivery

- Cardboard box

Measuring range	Reading	Rail cross-section	Order no.	List price
mm	mm	mm		EUR
500	0.1	25 x 6	0316 201	147.00
1000	0.1	25 x 6	0316 202	203.00

## 0316 Pair of replacement points, threaded f. 0316 2xx



### Model

- Thread M5

Length	Material	Diameter	Order no.	List price
mm		mm		EUR
58	Special steel, hardened	8	0316 110	7.70
58	Carbide	8	0316 111	30.30

## 0316 Beam trammel with roller



### Model

- Flat beam
- Special steel
- Locking screw
- Fine adjustment
- Factory standard

### Delivery

- Cardboard box
- From measuring range 2000 mm in transportation box

Measuring range	Reading	Rail cross-section	Order no.	List price
mm	mm	mm		EUR
500	0.1	30 x 7	0316 151	130.00
1000	0.1	30 x 7	0316 152	164.00
▪ 1500	0.1	30 x 7	0316 153	198.00
▪ 2000	0.1	30 x 7	0316 154	254.00



## 0317 Beam compass with round measuring beam



### Model

- Beam is made of special steel
- Guide groove
- Slide bars are made of aluminium
- mm graduation
- Locking screws
- Interchangeable hardened scribes
- Factory standard

### Delivery

- Cardboard box
- From measuring range 2000 mm in transportation box

☒	☒	Measuring range mm	Rail diameter mm	Reading mm	Order no.	List price EUR
<b>Without fine adjustment</b>						
		0 - 500	20	0.1	0317 001	68.00
		0 - 1000	20	0.1	0317 002	96.00
	▪	0 - 1500	20	0.1	0317 003	124.00
	▪	0 - 2000	20	0.1	0317 004	170.00
	▪	0 - 3000	28	0.1	0317 005	391.00
	▪	0 - 4000	28	0.1	0317 006	636.00
	▪	0 - 5000	28	0.1	0317 007	839.00
<b>With fine adjustment</b>						
		0 - 500	20	0.1	0317 101	81.00
		0 - 1000	20	0.1	0317 102	109.00
	▪	0 - 1500	20	0.1	0317 103	142.00
	▪	0 - 2000	20	0.1	0317 104	184.00
	▪	0 - 3000	28	0.1	0317 105	407.00
	▪	0 - 4000	28	0.1	0317 106	641.00
	▪	0 - 5000	28	0.1	0317 107	844.00

## 0317 Pair of replacement points (clamp)



☒	☒	Material	Diameter mm	Order no.	List price EUR
		Special steel, hardened	6	0317 010	8.40
		Carbide-tipped	6	0317 110	24.00



## 0314 Marking calipers

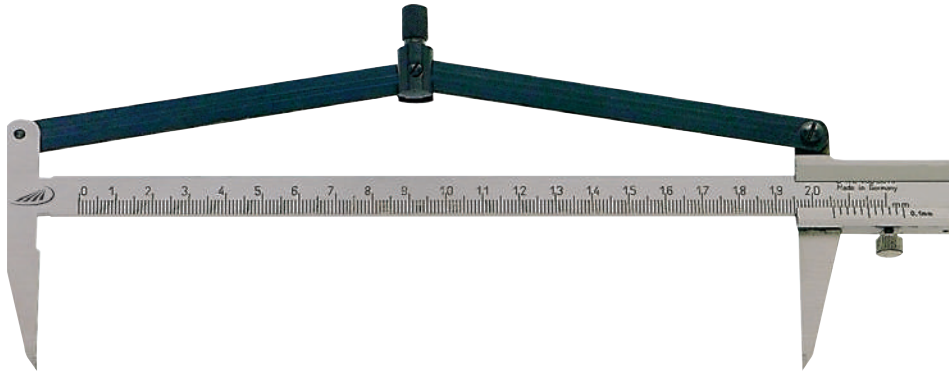

### Model

- Special steel
- Locking screw
- Laser graduated
- Factory standard

### Delivery

- Cardboard box

☒	☒	Measuring range	Diameter	Reading	Jaw length	Order no.	List price
		mm	mm	mm	mm		EUR
<b>Hardened scribing tips</b>							
		0 - 150	300	0.1	40	0314 002	77.00
		0 - 200	400	0.1	40	0314 003	88.00
		0 - 250	500	0.1	40	0314 004	92.00
		0 - 300	600	0.1	40	0314 005	98.00
<b>Carbide scribing tips</b>							
		0 - 150	300	0.1	40	0314 102	117.00
		0 - 200	400	0.1	40	0314 103	139.00
		0 - 250	500	0.1	40	0314 104	143.00
		0 - 300	600	0.1	40	0314 105	148.00

4

## 0308 Combined internal / external calipers



### Model

- Internal and external caliper
- Stainless steel
- Satin chrome finished scale
- With a rivetted hinge
- mm graduation for internal and external measurement

### Delivery

- Cardboard box

☒	☒	Length	Measuring range	Order no.	List price
		mm	mm		EUR
		190	0 - 120	0308 201	94.00
		250	0 - 160	0308 202	113.00
		310	0 - 200	0308 303	138.00
		460	0 - 300	0308 305	163.00





## 0303 Precision internal calipers





### Model

- With a rivetted hinge
- Special steel
- Hardened measuring points

### Delivery

- Cardboard box

		Length mm	Order no.	List price EUR
		150	0303 001	7.10
		175	0303 002	7.70
		200	0303 003	8.80
		250	0303 004	9.40
		300	0303 005	10.70
		400	0303 006	13.10
		500	0303 007	16.30
		600	0303 008	24.60
		800	0303 009	35.40
		1000	0303 010	65.00

## 0304 Precision external calipers





### Model

- With a rivetted hinge
- Special steel
- Hardened measuring points

### Delivery

- Cardboard box

		Length mm	Order no.	List price EUR
		150	0304 001	7.10
		175	0304 002	7.70
		200	0304 003	8.80
		250	0304 004	9.40
		300	0304 005	10.70
		400	0304 006	13.10
		500	0304 007	16.30
		600	0304 008	24.60
		800	0304 009	35.40
		1000	0304 010	65.00



### 0312 Spring internal calipers



#### Model

- Internal caliper with quick release set screw
- Special steel
- Quick release set screw and spring are burnished

#### Delivery

- Cardboard box

	Length mm	Order no.	List price EUR
	100	0312 101	3.40
	150	0312 103	4.90
	200	0312 105	5.90
	250	0312 107	7.30
	300	0312 108	8.80

### 0313 Spring external calipers



#### Model

- External caliper with quick release set screw
- Special steel
- Quick release set screw and spring are burnished

#### Delivery

- Cardboard box

	Length mm	Order no.	List price EUR
	100	0313 101	3.40
	150	0313 103	4.90
	200	0313 105	5.90
	250	0313 107	7.30
	300	0313 108	8.80



## 0343 Marking calipers

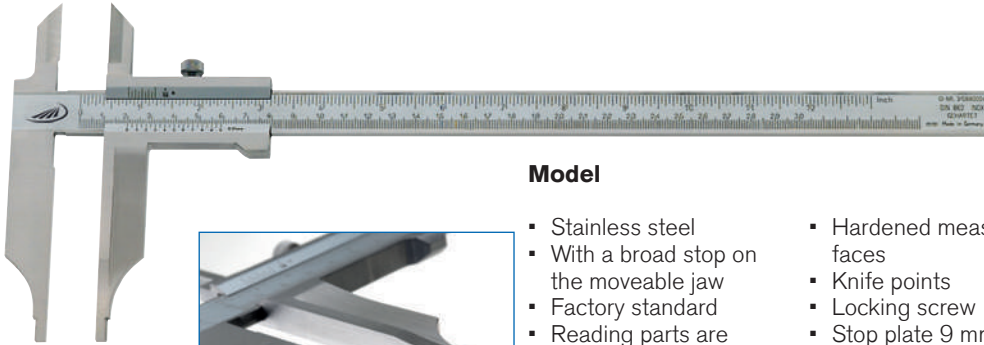

### Model

- Stainless steel
- With a broad stop on the moveable jaw
- Factory standard
- Reading parts are satin chrome finished
- Hardened measuring faces
- Knife points
- Locking screw
- Stop plate 9 mm

### Delivery

- Cardboard box

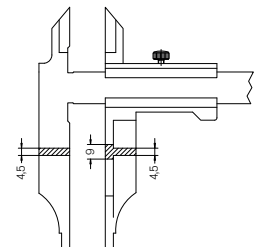

✂	Measuring range	Reading	Rail cross-section	Jaw length	Jaws for inside measurements	Order no.	List price
	mm	mm	mm	mm	mm		EUR
	0 - 250	0.05	20 x 5	90	10	0343 501	266.00
	0 - 300	0.05	20 x 5	90	10	0343 503	299.00

## 0344 Marking calipers

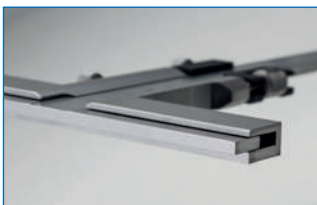
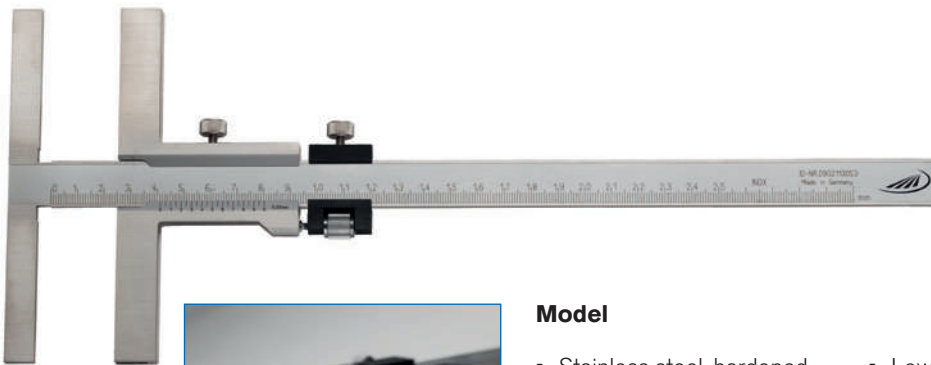

### Model

- Stainless steel, hardened
- Long T-shaped marking edge
- Factory standard
- Reading parts are satin chrome finished
- Low set master scale
- Fine adjustment
- Locking screw

### Delivery

- Cardboard box

✂	Measuring range	Reading	Rail cross-section	Length of edge	Order no.	List price
	mm	mm	mm	mm		EUR
	0 - 160	0.05	18 x 4	135	0344 501	130.00
	0 - 250	0.05	18 x 4	135	0344 502	166.00
	0 - 300	0.05	18 x 4	160	0344 503	210.00
	0 - 500	0.05	18 x 4	160	0344 505	446.00



## 0321 Marking gauges

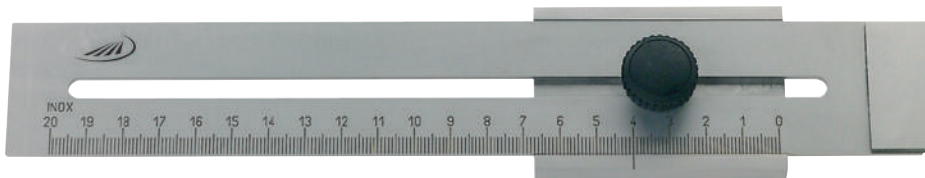

### Model

- Flat, stable construction
- Stainless steel, chrome finished
- Locking screw
- Hardened stop face
- mm graduated scale
- Factory standard

### Delivery

- Cardboard box

☒ ☒	Measuring range mm	Reading mm	Rail cross-section mm	Order no.	List price EUR
	0 - 200	1	40	0321 301	22.70
	0 - 250	1	40	0321 302	25.40
	0 - 300	1	40	0321 303	25.90
	0 - 500	1	40	0321 305	49.30

## 0323 Marking gauges

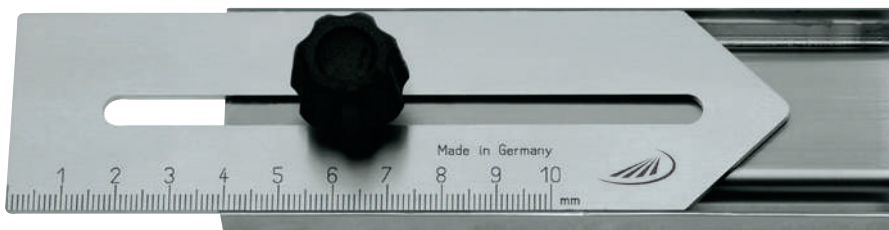

### Model

- Stainless steel
- Locking screw
- For marking by scale as well as for marking of 45° - or 90° - mitres
- mm graduation
- Factory standard

### Delivery

- Cardboard box

☒ ☒	Measuring range mm	Reading mm	Rail cross-section mm	Order no.	List price EUR
	100	1	40	0323 308	16.90
	200	1	40	0323 318	21.60



## 0318 Marking calipers

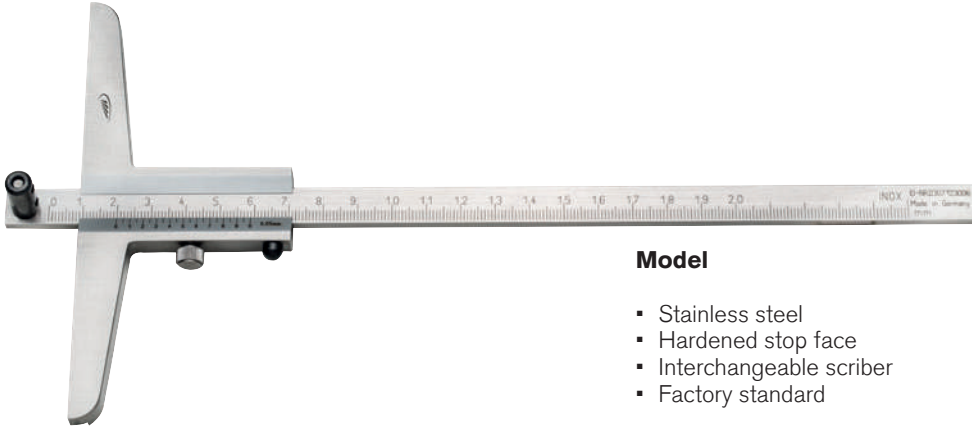

### Model

- Stainless steel
- Hardened stop face
- Interchangeable scriber
- Factory standard

### Delivery

- Cardboard box

☒	☒	Measuring range	Reading	Rail cross-section	Length of beam	Order no.	List price
		mm	mm	mm	mm		EUR
		0 - 200	0.05	12 x 4	130	0318 201	154.00
		0 - 300	0.05	12 x 4	130	0318 203	164.00

## 0318 Replacement scribers



☒	☒	Material	Order no.	List price
				EUR
		Special steel, hardened	0318 210	13.00
		Carbide-tipped	0318 211	42.20

## 0322 Marking gauges with guide roll



### Model

- Stainless steel, hardened
- Reading parts are satin chrome finished
- Guide roll
- Locking screw
- Interchangeable scriber made of hardened steel
- Factory standard

### Delivery

- Cardboard box

☒	☒	Measuring range	Reading	Order no.	List price
		mm	mm		EUR
		0 - 200	0.05	0322 501	25.90
		0 - 400	0.05	0322 503	40.60

### Accessories

Replacement scribers ø 2 mm

Order no.	List price
	EUR
0322 510	4.60



## 0319 Marking gauges with a round measuring beam

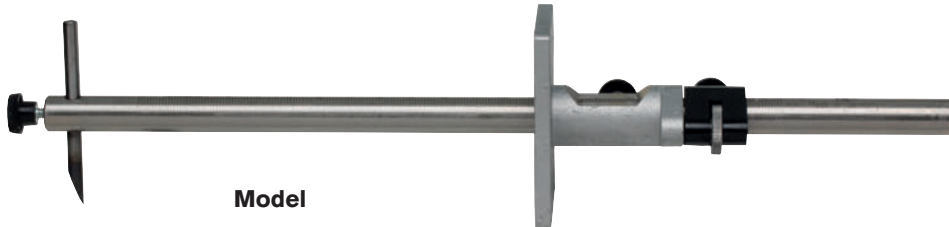

### Model

- With guide groove
- Stainless steel beam
- Slide bars are made of steel, **rectangular stop plate**
- Scriber interchangeable, made of hardened steel
- mm graduation
- Factory standard

### Delivery

- Cardboard box

Measuring range mm	Beam diameter mm	Reading mm	Order no.	List price EUR
<b>Without fine adjustment</b>				
0 - 200	12	0.1	0319 001	36.80
0 - 300	12	0.1	0319 002	46.10
0 - 400	12	0.1	0319 003	66.00
0 - 500	12	0.1	0319 004	89.00
<b>With fine adjustment</b>				
0 - 200	12	0.1	0319 101	47.10
0 - 300	12	0.1	0319 102	55.00
0 - 400	12	0.1	0319 103	76.00
0 - 500	12	0.1	0319 104	96.00

## 0320 Marking gauges with a round measuring beam

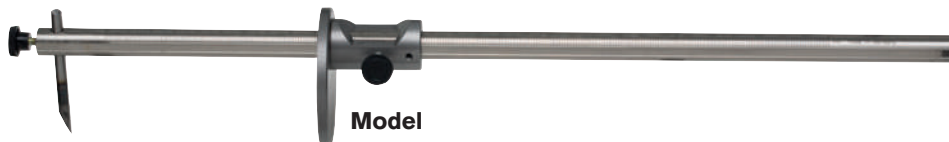

### Model

- With guide groove
- Stainless steel beam
- Slide bars are made of steel, **round stop plate**
- Scriber interchangeable, made of hardened steel
- mm graduation

### Delivery

- Cardboard box

Measuring range mm	Beam diameter mm	Reading mm	Order no.	List price EUR
0 - 300	12	0.1	0320 001	46.10
0 - 500	12	0.1	0320 002	89.00
<b>Hardened stop plate</b>				
0 - 300	12	0.1	0320 101	72.00
0 - 500	12	0.1	0320 102	113.00

## 0319 Replacement scribers

Material	Order no.	List price EUR
Special steel, hardened	0319 010	3.90
Carbide	0319 510	40.00



## 0345 / 0347 Analogue height and scribing gauges

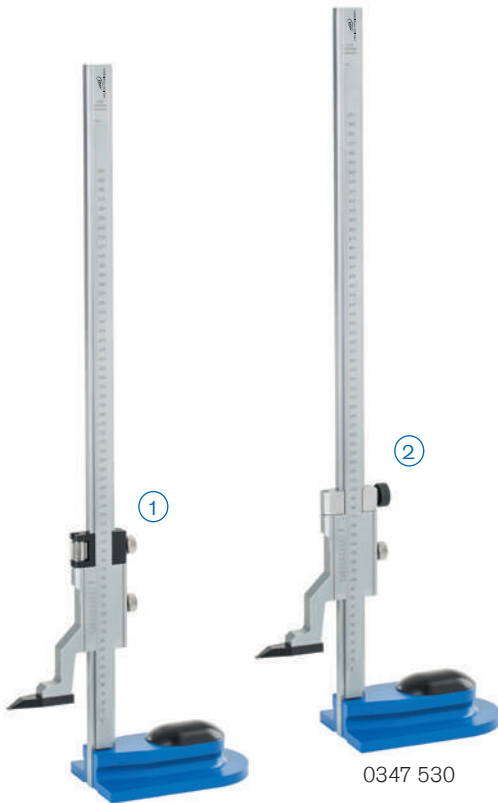

0345 530

0347 530

### Model

- Measuring beam is made from stainless steel
- Vernier and scale are satin chrome finished
- Parallax-free reading
- Setting screw
- Fine adjustment
- Accurate fine adjustment on gear rack and setting wheel with pinion
- Steel base with dirt grooves
- Scribing possible from base plate level
- Factory standard

### Delivery

- With exchangeable scribe, carbide tipped, 75 mm

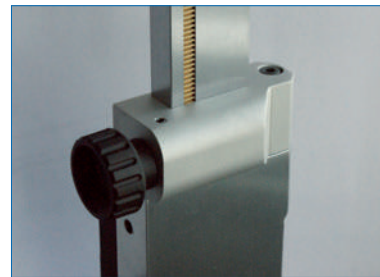

② Fine adjustment on gear rack

☒	☒	Measuring range mm	Reading mm	Base dimensions mm	Rail cross-section mm	Order no.	List price EUR
<b>With fine adjustment</b>							
		0 - 300	0.02	145 x 90 x 44	30 x 12	0345 522	389.00
		0 - 600	0.02	189 x 118 x 44	30 x 12	0345 530	487.00
		0 - 1000	0.02	189 x 118 x 44	30 x 12	0345 534	670.00
<b>With pinion</b>							
		0 - 300	0.02	145 x 90 x 44	30 x 12	0347 522	497.00
		0 - 600	0.02	189 x 118 x 44	30 x 12	0347 530	627.00
		0 - 1000	0.02	189 x 118 x 44	30 x 12	0347 534	865.00

## 0345 Replacement scribers for 0345 / 0347



### Model

- Carbide tipped
- Packing: individually packed

☒	☒	Length mm	Material	Order no.	List price EUR
		75	Carbide-tipped	0345 910	124.00
		150	Carbide-tipped	0345 912	138.00



## 0345 / 0347 DIGI-MET® Height and scribing gauges



### Model

- Measuring beam is made from stainless steel
- LCD-display 11 mm
- Setting screw
- Fine adjustment
- Accurate fine adjustment on gear rack and setting wheel with pinion
- Steel base with dirt grooves
- Scribing possible from base plate level
- Factory standard

### Functions



- ON / OFF
- Set to zero at any point
- mm / inch switching
- PRESET-Function (setting a numerical value)
- Hold
- ABS (display can be set to zero without losing the Preset value)
- Reversal of counting direction
- Factor input
- Data output Proximity USB + RS232

### Delivery

- With interchangeable scribing jaws, carbide tipped, 75 mm

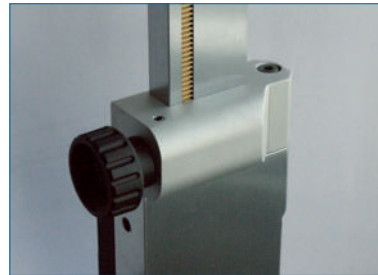

② Fine adjustment on gear rack

Icon	Measuring range		Reading		Base dimensions mm	Rail cross-section mm	Order no.	List price EUR
	mm	inch	mm	inch				
<b>With fine adjustment</b>								
	0 - 300	0 - 12	0.01	.0005	145 x 90 x 44	30 x 12	0345 722	562.00
	0 - 600	0 - 24	0.01	.0005	189 x 118 x 44	30 x 12	0345 730	702.00
	0 - 1000	0 - 39	0.01	.0005	189 x 118 x 44	30 x 12	0345 734	973.00
<b>With pinion</b>								
	0 - 300	0 - 12	0.01	.0005	145 x 90 x 44	30 x 12	0347 722	692.00
	0 - 600	0 - 24	0.01	.0005	189 x 118 x 44	30 x 12	0347 730	865.00
	0 - 1000	0 - 39	0.01	.0005	189 x 118 x 44	30 x 12	0347 734	1190.00

### Accessories

Accessories	Order no.	List price EUR
Battery, 3V-Lithium, CR 2032	0220 704	3.90
Data cable Proximity to USB	1998 760	147.00

## 0345 Replacement scribers for 0345 / 0347

### Model

- Carbide tipped
- Packing: individually packed

Icon	Length mm	Material	Order no.	List price EUR
	75	Carbide-tipped	0345 910	124.00
	150	Carbide-tipped	0345 912	138.00





## 0349 DIGI-MET® Height gauges with sliding scriber



0349 722\*

### Model

- Measuring beam is made from special steel
- LCD-display 11 mm
- Fine adjustment
- Setting screw
- Steel base with dirt grooves
- Scribing possible from base plate level

### Functions

- ON / OFF
- Set to zero at any point
- mm / inch switching
- PRESET-Function (setting a numerical value)
- Hold
- ABS (display can be set to zero without losing the Preset value)
- Reversal of counting direction
- Factor input
- Data output Proximity USB + RS232

### Delivery

- With interchangeable scribing jaws, carbide tipped

✕	📏	Measuring range		Reading		Base dimensions	Beam	Order no.	List price
		mm	inch	mm	inch	mm	mm		EUR
		0 - 300	0 - 12	0.01	.0005	145 x 90 x 44	30 x 12	0349 722	594.00
		0 - 600	0 - 24	0.01	.0005	189 x 118 x 44	30 x 12	0349 730	756.00
		0 - 1000	0 - 39	0.01	.0005	189 x 118 x 44	30 x 12	0349 734	1027.00

### Accessories

Battery, 3V-Lithium, CR 2032  
Data cable Proximity to USB

### List price

EUR

0220 704 3.90  
1998 760 147.00

\*Figure does not show standard delivery content

## 0349 Replacement scribers for 0349



✕	📏	Length mm	Material	Order no.	List price EUR
<b>Cranked scriber, for marking operations from base</b>					
		270	Special steel, hardened	0349 912	133.00
		270	Carbide-tipped	0349 916	169.00
<b>Straight scriber</b>					
		270	Special steel, hardened	0349 910	114.00
		270	Carbide-tipped	0349 914	148.00

Limited measuring range while using a cranked scriber



## 0331 Replacement scriber for height gauges not any longer included in our catalogue



Order no. Scriber	Order no. Height gauge	0330...	0331...	0336...	0338...	0340...	0342...	Material	Length mm	Shaft mm	List price EUR
0331 011			●		●			straight, hardened steel	270	8 x 8	114.00
0331 030			●					cranked, hardened steel	270	8 x 8	133.00
0331 111			●		●			straight, carbide tipped	270	8 x 8	148.00
0331 130			●					cranked, carbide tipped	270	8 x 8	169.00
0334 101		●		●		●	●	straight, carbide tipped	65	8 x 8	75.00
0334 102		●		●		●	●	straight, carbide tipped	75	-	124.00
0334 105				●				straight, carbide tipped	120	-	91.00
0334 106				●				straight, carbide tipped	150	-	138.00
0338 354					●			cranked, hardened steel	270	8 x 8	146.00
0338 357					●			cranked, carbide tipped	270	8 x 8	190.00



# SAMPLES SQUARES

SQUARE **WITH BASE**

SQUARE **WITHOUT BASE**



HIGH **QUALITY**

MADE IN **GERMANY**

Manufactured according to **DIN 875**

**Highest** precision:  
Accuracy **grade 0**

Blade length up to **2 meters**  
(Accuracy grade 2)

Made from **special** or **stainless** steel

More **highlights** from our range of **squares**



**ACUTE ANGLE**  
SQUARES



**MITRE SQUARES**



**BEVEL**  
**PROTRACTORS**

## 5. CHAPTER SQUARES, PROTRACTORS AND BEVEL PROTRACTORS

196	Squares with / without base
200	Steel squares
201	Squares with hard and slim blade
203	Knife edge squares
204	Inspection set
205	Centre squares / Flange squares
206	Mitre / Acute angle squares
208	Squares for specific measuring tasks and target groups
210	Wooden cases
211	Protractors
213	Universal bevel protractors

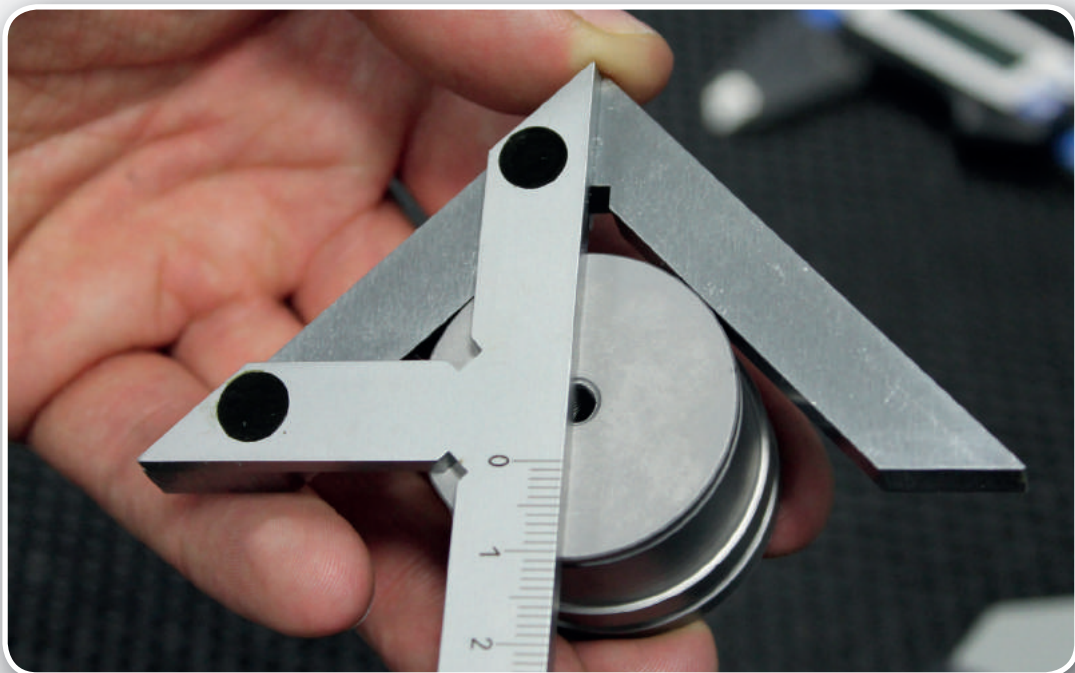



## 0368 Squares with base accuracy grade 0



### Model

- DIN 875
- Accuracy grade 0
- For exact angle testing (for example: tool making)

### Delivery

- Cardboard box
- From blade length 1000 mm in a transportation box

		Jaw length mm	Cross-section mm	Order no.	List price EUR	DIN 875
<b>Special steel</b>						
		75 x 50	15 x 5	0368 102	16.00	
		100 x 70	20 x 5	0368 103	18.70	
		150 x 100	25 x 5	0368 104	28.20	
		200 x 130	30 x 6	0368 105	36.20	
		250 x 165	35 x 7	0368 106	52.00	
		300 x 200	40 x 8	0368 107	71.00	
		400 x 265	45 x 10	0368 108	154.00	
		500 x 330	50 x 10	0368 109	225.00	
		600 x 400	50 x 10	0368 110	322.00	
		750 x 500	60 x 12	0368 111	550.00	
	▪	1000 x 660	70 x 15	0368 112	987.00	
<b>Stainless steel</b>						
		75 x 50	15 x 5	0368 202	24.00	
		100 x 70	20 x 5	0368 203	25.80	
		150 x 100	25 x 5	0368 204	44.40	
		200 x 130	30 x 6	0368 205	64.00	
		250 x 165	35 x 7	0368 206	93.00	
		300 x 200	40 x 8	0368 207	104.00	
		400 x 265	45 x 10	0368 208	195.00	
		500 x 330	50 x 10	0368 209	270.00	
		600 x 400	50 x 10	0368 210	401.00	
		750 x 500	60 x 12	0368 211	689.00	
	▪	1000 x 660	70 x 15	0368 212	1462.00	

## 0369 Squares without base accuracy grade 0



### Model

- DIN 875
- Accuracy grade 0
- For exact angle testing (for example: tool making)

### Delivery

- Cardboard box
- From blade length 1000 mm in a transportation box

		Jaw length mm	Cross-section mm	Order no.	List price EUR	DIN 875
<b>Special steel</b>						
		75 x 50	15 x 5	0369 102	10.50	
		100 x 70	20 x 5	0369 103	11.80	
		150 x 100	25 x 5	0369 104	14.50	
		200 x 130	30 x 6	0369 105	24.00	
		250 x 165	35 x 7	0369 106	33.10	
		300 x 200	40 x 8	0369 107	42.50	
		400 x 265	45 x 10	0369 108	104.00	
		500 x 330	50 x 10	0369 109	128.00	
		600 x 400	50 x 10	0369 110	253.00	
		750 x 500	60 x 12	0369 111	470.00	
	▪	1000 x 660	70 x 15	0369 112	838.00	
<b>Stainless steel</b>						
		75 x 50	15 x 5	0369 202	17.40	
		100 x 70	20 x 5	0369 203	19.10	
		150 x 100	25 x 5	0369 204	25.30	
		200 x 130	30 x 6	0369 205	38.30	
		250 x 165	35 x 7	0369 206	51.00	
		300 x 200	40 x 8	0369 207	71.00	
		400 x 265	45 x 10	0369 208	135.00	
		500 x 330	50 x 10	0369 209	188.00	
		600 x 400	50 x 10	0369 210	315.00	
		750 x 500	60 x 12	0369 211	588.00	
	▪	1000 x 660	70 x 15	0369 212	1103.00	





## 0385 Inspection squares with base accuracy grade 0, hardened



### Model

- DIN 875
- Accuracy grade 0
- For exact angle testing (for example: tool making)

### Delivery

- Cardboard box

**DIN  
875**

	Jaw length mm	Cross-section mm	Order no.	List price EUR
<b>Special steel</b>				
	50 x 40	15 x 4	0385 102	25.30
	75 x 50	15 x 4	0385 103	27.00
	100 x 70	20 x 5	0385 104	32.30
	150 x 100	25 x 6	0385 105	48.20
	200 x 130	30 x 7	0385 106	67.00
	300 x 200	40 x 8	0385 108	117.00
<b>Stainless steel</b>				
	50 x 40	15 x 4	0385 202	35.10
	75 x 50	15 x 4	0385 203	39.00
	100 x 70	20 x 5	0385 204	48.20
	150 x 100	25 x 6	0385 205	64.00
	200 x 130	30 x 7	0385 206	82.00
	300 x 200	40 x 8	0385 208	121.00

## 0386 Inspection squares without base accuracy grade 0, hardened



### Model

- DIN 875
- Accuracy grade 0
- For exact angle testing (for example: tool making)

### Delivery

- Cardboard box

**DIN  
875**

5

	Jaw length mm	Cross-section mm	Order no.	List price EUR
<b>Special steel</b>				
	50 x 40	15 x 4	0386 102	19.10
	75 x 50	15 x 4	0386 103	20.50
	100 x 70	20 x 5	0386 104	25.10
	150 x 100	25 x 6	0386 105	31.10
	200 x 130	30 x 7	0386 106	40.10
	300 x 200	40 x 8	0386 108	77.00
<b>Stainless steel</b>				
	50 x 40	15 x 4	0386 202	24.20
	75 x 50	15 x 4	0386 203	27.40
	100 x 70	20 x 5	0386 204	32.30
	150 x 100	25 x 6	0386 205	41.90
	200 x 130	30 x 7	0386 206	54.00
	300 x 200	40 x 8	0386 208	107.00



## 0370 Squares with base accuracy grade 1



### Model

- DIN 875
- Accuracy grade 1
- For angle testing in production and factory

### Delivery

- Cardboard box
- From blade length 1000 mm in a transportation box

		Jaw length mm	Cross-section mm	Order no.	List price EUR
<b>Special steel</b>					
		75 x 50	15 x 5	0370 102	12.00
		100 x 70	20 x 5	0370 103	13.50
		150 x 100	25 x 5	0370 104	18.00
		200 x 130	30 x 6	0370 105	22.50
		250 x 165	35 x 7	0370 106	30.00
		300 x 200	40 x 8	0370 107	37.00
		400 x 265	45 x 10	0370 108	99.00
		500 x 330	50 x 10	0370 109	145.00
		600 x 400	50 x 10	0370 110	205.00
		750 x 500	60 x 12	0370 111	410.00
	▪	1000 x 660	70 x 15	0370 112	690.00
<b>Stainless steel</b>					
		75 x 50	15 x 5	0370 202	16.00
		100 x 70	20 x 5	0370 203	19.00
		150 x 100	25 x 5	0370 204	26.00
		200 x 130	30 x 6	0370 205	35.00
		250 x 165	35 x 7	0370 206	49.00
		300 x 200	40 x 8	0370 207	63.00
		400 x 265	45 x 10	0370 208	168.00
		500 x 330	50 x 10	0370 209	206.00
		600 x 400	50 x 10	0370 210	350.00
		750 x 500	60 x 12	0370 211	542.00
	▪	1000 x 660	70 x 15	0370 212	876.00

**DIN  
875**

## 0371 Squares without base accuracy grade 1



### Model

- DIN 875
- Accuracy grade 1
- For angle testing in production and factory

### Delivery

- Cardboard box
- From blade length 1000 mm in a transportation box

		Jaw length mm	Cross-section mm	Order no.	List price EUR
<b>Special steel</b>					
		75 x 50	15 x 5	0371 102	8.50
		100 x 70	20 x 5	0371 103	9.50
		150 x 100	25 x 5	0371 104	11.50
		200 x 130	30 x 6	0371 105	16.00
		250 x 165	35 x 7	0371 106	22.50
		300 x 200	40 x 8	0371 107	29.00
		400 x 265	45 x 10	0371 108	69.00
		500 x 330	50 x 10	0371 109	90.00
		600 x 400	50 x 10	0371 110	125.00
		750 x 500	60 x 12	0371 111	280.00
	▪	1000 x 660	70 x 15	0371 112	480.00
<b>Stainless steel</b>					
		75 x 50	15 x 5	0371 202	9.40
		100 x 70	20 x 5	0371 203	11.40
		150 x 100	25 x 5	0371 204	16.00
		200 x 130	30 x 6	0371 205	22.20
		250 x 165	35 x 7	0371 206	32.30
		300 x 200	40 x 8	0371 207	39.40
		400 x 265	45 x 10	0371 208	130.00
		500 x 330	50 x 10	0371 209	163.00
		600 x 400	50 x 10	0371 210	269.00
		750 x 500	60 x 12	0371 211	493.00
	▪	1000 x 660	70 x 15	0371 212	795.00

**DIN  
875**



## 0372 Squares with base accuracy grade 2



### Model

- Special steel
- DIN 875
- Accuracy grade 2
- For angle testing in production and factory

### Delivery

- Cardboard box
- From blade length 1500 mm in a transportation box

**DIN  
875**

☒	☒	Jaw length mm	Cross-section mm	Order no.	List price EUR
		75 x 50	15 x 5	0372 102	10.20
		100 x 70	20 x 5	0372 103	11.50
		150 x 100	25 x 5	0372 104	15.00
		200 x 130	30 x 6	0372 105	19.00
		250 x 165	35 x 7	0372 106	25.50
		300 x 175	35 x 7	0372 107	32.00
		400 x 200	35 x 7	0372 108	53.00
		500 x 250	40 x 8	0372 109	70.00
		600 x 300	40 x 8	0372 110	95.00
		750 x 375	45 x 10	0372 111	120.00
		1000 x 500	50 x 10	0372 112	165.00
	▪	1500 x 750	60 x 12	0372 113	590.00
	▪	2000 x 1000	60 x 12	0372 114	950.00

## 0373 Squares without base accuracy grade 2



### Model

- Special steel
- DIN 875
- Accuracy grade 2
- For angle testing in production and factory

### Delivery

- Cardboard box
- From blade length 1500 mm in a transportation box

**DIN  
875**

**5**

☒	☒	Jaw length mm	Cross-section mm	Order no.	List price EUR
		75 x 50	15 x 5	0373 102	7.20
		100 x 70	20 x 5	0373 103	8.00
		150 x 100	25 x 5	0373 104	11.00
		200 x 130	30 x 6	0373 105	13.00
		250 x 165	35 x 7	0373 106	18.00
		300 x 175	35 x 7	0373 107	23.00
		400 x 200	35 x 7	0373 108	36.00
		500 x 250	40 x 8	0373 109	52.00
		600 x 300	40 x 8	0373 110	70.00
		750 x 375	45 x 10	0373 111	94.00
		1000 x 500	50 x 10	0373 112	135.00
	▪	1500 x 750	60 x 12	0373 113	525.00
	▪	2000 x 1000	60 x 12	0373 114	840.00





## 0374 Steel squares with base



### Model

- Special steel, zinc coated
- Factory standard
- Simple design for angle test in steel and metal construction

### Delivery

- Cardboard box
- From blade length 1500 mm in a transportation box

✂	📏	Jaw length mm	Cross-section mm	Order no.	List price EUR
		100 x 70	20 x 5	0374 404	7.00
		150 x 100	20 x 5	0374 408	7.90
		200 x 130	20 x 5	0374 410	9.50
		250 x 160	25 x 5	0374 412	11.50
		300 x 180	25 x 5	0374 414	14.00
		400 x 230	30 x 5	0374 416	17.70
		500 x 280	30 x 5	0374 418	23.50
		600 x 330	30 x 5	0374 420	31.50
		750 x 375	30 x 5	0374 424	37.50
		1000 x 500	30 x 5	0374 428	57.00
	▪	1500 x 750	40 x 5	0374 430	199.00
	▪	2000 x 1000	40 x 5	0374 432	292.00

\*polished

## 0375 Steel squares without base



### Model

- Special steel, zinc coated
- Factory standard
- Simple design for angle test in steel and metal construction

### Delivery

- Cardboard box
- From blade length 1500 mm in a transportation box

✂	📏	Jaw length mm	Cross-section mm	Order no.	List price EUR
		100 x 70	20 x 5	0375 404	5.70
		150 x 100	20 x 5	0375 408	6.00
		200 x 130	20 x 5	0375 410	6.40
		250 x 160	25 x 5	0375 412	7.80
		300 x 180	25 x 5	0375 414	8.50
		400 x 230	30 x 5	0375 416	11.70
		500 x 280	30 x 5	0375 418	13.00
		600 x 330	30 x 5	0375 420	15.90
		750 x 375	30 x 5	0375 424	18.90
		1000 x 500	30 x 5	0375 428	24.50
	▪	1500 x 750	40 x 5	0375 430	96.00
	▪	2000 x 1000	40 x 5	0375 432	145.00

\*polished



## 0376 Squares with hard and slim blade, accuracy grade 1



### Model

### Delivery

DIN  
875

- Special steel
- DIN 875
- Accuracy grade 1
- For angle testing in production and factory

- Cardboard box



✂	☞	Jaw length mm	Cross section with narrow beam mm	Cross section with wide beam mm	Order no.	List price EUR
		75 x 50	14 x 10	14 x 3	0376 102	12.30
		100 x 70	16 x 10	16 x 3	0376 103	13.10
		150 x 100	20 x 12	22 x 3	0376 104	16.50
		200 x 130	24 x 14	24 x 3	0376 105	27.10

## 0376 Squares with hard and slim blade, accuracy grade 2



### Model

### Delivery

DIN  
875

- Special steel
- DIN 875
- Accuracy grade 2
- For angle testing in production and factory

- Cardboard box



✂	☞	Jaw length mm	Cross section with narrow beam mm	Cross section with wide beam mm	Order no.	List price EUR
		75 x 50	14 x 2	14 x 10	0376 112	11.50
		100 x 70	18 x 2	16 x 10	0376 113	12.20
		150 x 100	22 x 3	20 x 12	0376 114	14.80
		200 x 130	24 x 3	24 x 14	0376 115	20.70
		250 x 160	28 x 3	28 x 16	0376 116	25.60
		300 x 175	30 x 3	32 x 18	0376 117	30.50



## 0390 Squares with hard and slim blade, hardened, accuracy grade 0



### Model

- DIN 875
- Accuracy grade 0
- For exact angle testing (for example: tool making)

### Delivery

- Cardboard box

DIN  
875



▶	🏠	Jaw length mm	Cross section with narrow beam mm	Cross section with wide beam mm	Order no.	List price EUR
<b>Special steel</b>						
		50 x 40	14 x 10	16 x 2	0390 102	36.20
		75 x 50	14 x 10	18 x 2	0390 103	36.20
		100 x 70	16 x 10	18 x 2	0390 104	41.90
		150 x 100	20 x 12	22 x 3	0390 105	53.00
		200 x 130	24 x 14	26 x 3	0390 106	72.00
		300 x 200	30 x 18	32 x 3	0390 108	121.00
<b>Stainless steel</b>						
		50 x 40	14 x 10	16 x 2	0390 202	47.90
		75 x 50	14 x 10	18 x 2	0390 203	54.00
		100 x 70	16 x 10	18 x 2	0390 204	69.00
		150 x 100	20 x 12	22 x 3	0390 205	89.00
		200 x 130	24 x 14	26 x 3	0390 206	111.00
		300 x 200	30 x 18	32 x 3	0390 208	171.00

## 0391 Knife edge squares with hard and slim blade, hardened, accuracy grade 00



### Model

- With knife edge
- DIN 875
- Accuracy grade 00
- For exact flatness testing (for example: in production)

### Delivery

- Cardboard box

DIN  
875



▶	🏠	Jaw length mm	Cross section with narrow beam mm	Cross section with wide beam mm	Order no.	List price EUR
<b>Special steel, non-glare knife edge</b>						
		50 x 40	14 x 10	16 x 2	0391 102	56.00
		75 x 50	14 x 10	18 x 2	0391 103	56.00
		100 x 70	16 x 10	18 x 2	0391 104	73.00
		150 x 100	20 x 12	22 x 3	0391 105	92.00
		200 x 130	24 x 14	26 x 3	0391 106	124.00
		300 x 200	30 x 18	32 x 3	0391 108	181.00
<b>Stainless steel</b>						
		50 x 40	14 x 10	16 x 2	0391 202	67.00
		75 x 50	14 x 10	18 x 2	0391 203	75.00
		100 x 70	16 x 10	18 x 2	0391 204	85.00
		150 x 100	20 x 12	22 x 3	0391 205	109.00
		200 x 130	24 x 14	26 x 3	0391 206	140.00
		300 x 200	30 x 18	32 x 3	0391 208	227.00



## 0388 Knife edge squares, hardened, accuracy grade 00



### Model

- DIN 875
- Accuracy grade 00
- For exact angle and flatness testing (for example: tool making)

### Delivery

- Cardboard box

DIN 875

	Jaw length mm	Cross-section mm	Order no.	List price EUR
<b>Special steel, non-glare knife edge</b>				
	50 x 40	14 x 4	0388 102	20.20
	75 x 50	15 x 4	0388 103	24.00
	100 x 70	20 x 5	0388 104	28.70
	150 x 100	25 x 6	0388 105	38.60
	200 x 130	30 x 7	0388 106	54.00
	300 x 200	40 x 8	0388 108	94.00
<b>Stainless steel</b>				
	50 x 40	14 x 4	0388 202	24.00
	75 x 50	15 x 4	0388 203	28.20
	100 x 70	20 x 5	0388 204	34.00
	150 x 100	25 x 6	0388 205	43.90
	200 x 130	30 x 7	0388 206	65.00
	300 x 200	40 x 8	0388 208	142.00
	500 x 330	40 x 10	0388 210	676.00

## 0394 Knife edge squares



0394 101

0394 110

### Model

- **0394101**
- Reading parts are satin chrome finished
- Sliding knife 7 x 7 x 60 mm
- Angle  $\pm 5^\circ$
- Handle 40 x 23 x 9 mm
- For testing on short edges and grooves through the sliding knife edge

### Delivery

- **0394110**
- Wooden case
- Reading parts are satin chrome finished
- Sliding knife edge 7 x 7 x 60 mm
- Handle 40 x 23 x 9 mm
- For tests at short grooves through the sliding straight edge

	Dimensions mm	Cross-section mm	Order no.	List price EUR
	60 x 35 x 13	7 x 7 x 100	0394 101	212.00
	40 x 23 x 9	7 x 7 x 60	0394 110	85.00

Accessories	Order no.	List price EUR
Replacement rule for 0394	0394 104	38,30



## 0387 Knife edge squares



### Model

- Stainless steel
- DIN 875
- Accuracy grade 00
- Angle 90°
- Knife edge on the inside

### Delivery

- Cardboard box

**DIN  
875**

✕	☒	Jaw length mm	Cross section with narrow beam mm	Cross section with wide beam mm	Order no.	List price EUR
		25 x 20	5 x 3.5	6 x 3.5	0387 200	17.90
		40 x 28	5 x 3.5	8 x 3.5	0387 201	17.90

## 0397 5 piece inspection set



### Model

set consisting of:

- Knife edge square, stainless steel 75 x 50 mm
- Knife edge square, stainless steel 40 x 28 mm
- Knife edge square, stainless steel 25 x 20 mm
- Knife edge rule, special steel 100 mm
- Gauge block scriber 60 x 9 x 9 mm

### Delivery

- Wooden case

✕	☒	Order no.	List price EUR
		0397 101	184.00





## 0380 Centre squares



### Model

- Special steel
- Factory standard
- With mm graduated scale
- Scale has a satin chrome finish

### Delivery

- Cardboard box

☰	☰	Jaw length mm	For shaft dia. up to mm	Order no.	List price EUR
<b>Special steel</b>					
		400 x 250	380.0	0380 108	262.00
		500 x 330	530.0	0380 109	466.00
<b>Special steel, chrome finished</b>					
		100 x 70	90.0	0380 103	57.00
		150 x 130	190.0	0380 104	68.00
		200 x 150	220.0	0380 105	85.00
		250 x 160	230.0	0380 106	94.00
		300 x 180	280.0	0380 107	102.00

## 0396 Flange squares



### Model

- Special steel, zinc coated
- Factory standard
- For accurately aligning flanges e.g. in plumbing and sanitary works in pipeline

### Delivery

- Cardboard box
- From blade length 600 mm in transportation box

☰	☰	Jaw length mm	Cross-section mm	Order no.	List price EUR
		300 x 300	30 x 5	0396 414	16.50
		400 x 400	30 x 5	0396 416	19.50
		500 x 500	30 x 5	0396 418	23.00
	▪	600 x 600	30 x 5	0396 420	29.00
	▪	800 x 800	30 x 5	0396 426	35.00



## 0395 Mitre squares 120°



### Model

- Special steel
- Factory standard

### Delivery

- Cardboard box

▶	▶	Jaw length mm	Cross-section mm	Order no.	List price EUR
<b>Flat, without base</b>					
		50 x 50	15 x 5	0395 132	8.60
		75 x 75	18 x 5	0395 133	11.00
		100 x 100	20 x 5	0395 134	13.30

## 0395 Mitre squares 135°



### Model

- Special steel
- Factory standard

### Delivery

- Cardboard box

▶	▶	Jaw length mm	Cross-section mm	Order no.	List price EUR
<b>With base</b>					
		120 x 80	20 x 5	0395 142	19.10
		150 x 100	20 x 5	0395 143	21.60
		200 x 130	25 x 5	0395 144	28.20
<b>Flat, without base</b>					
		50 x 50	15 x 5	0395 136	8.60
		75 x 75	18 x 5	0395 137	11.00
		100 x 100	20 x 5	0395 138	13.30
		120 x 80	20 x 5	0395 146	14.10
		150 x 100	20 x 5	0395 147	19.10
		200 x 130	25 x 5	0395 148	25.80



## 0395 Acute angle squares 60°



### Model

- Special steel
- Factory standard

### Delivery

- Cardboard box

		Jaw length mm	Cross-section mm	Order no.	List price EUR
<b>With base</b>					
		120 x 80	20 x 5	0395 122	26.50
		150 x 100	20 x 5	0395 123	30.30
		200 x 130	25 x 5	0395 124	40.60
<b>Flat, without base</b>					
		120 x 80	20 x 5	0395 126	19.00
		150 x 100	20 x 5	0395 127	21.20
		200 x 130	25 x 5	0395 128	29.80

## 0395 Acute angle squares 45°



### Model

- Special steel
- Factory standard

### Delivery

- Cardboard box

		Jaw length mm	Cross-section mm	Order no.	List price EUR
<b>With base</b>					
		120 x 80	20 x 5	0395 102	28.00
		150 x 100	20 x 5	0395 103	31.10
		200 x 130	25 x 5	0395 104	41.90
<b>Flat, without base</b>					
		120 x 80	20 x 5	0395 106	19.70
		150 x 100	20 x 5	0395 107	21.60
		200 x 130	25 x 5	0395 108	31.10





## 0396 Carpenters squares

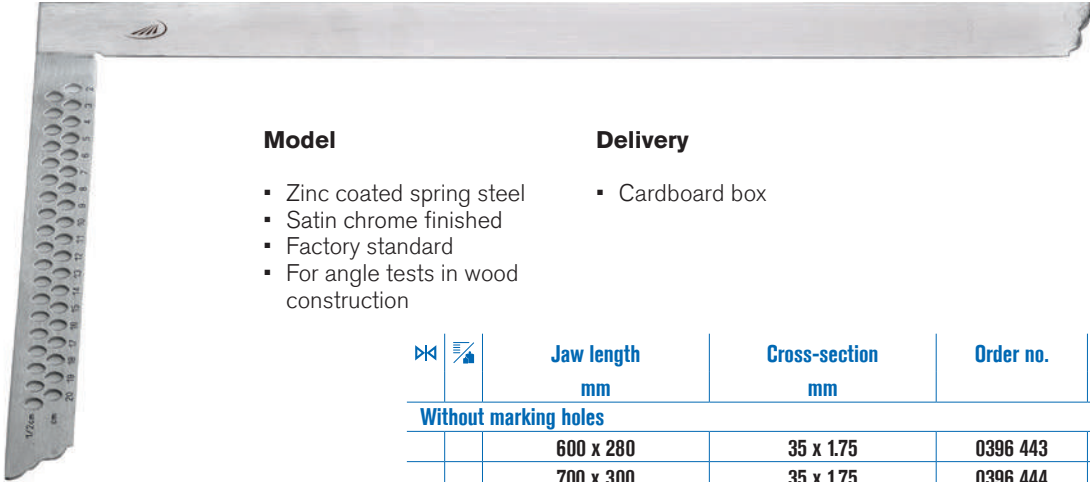

### Model

- Zinc coated spring steel
- Satin chrome finished
- Factory standard
- For angle tests in wood construction

### Delivery

- Cardboard box

Marked	Weight	Jaw length mm	Cross-section mm	Order no.	List price EUR
<b>Without marking holes</b>					
		600 x 280	35 x 1.75	0396 443	10.50
		700 x 300	35 x 1.75	0396 444	12.40
		800 x 320	35 x 1.75	0396 445	13.40
		1000 x 380	35 x 1.75	0396 446	17.30
<b>With marking holes</b>					
		600 x 280	35 x 1.75	0396 453	13.20
		700 x 300	35 x 1.75	0396 454	14.90
		800 x 320	35 x 1.75	0396 455	16.60
		1000 x 380	35 x 1.75	0396 456	20.30

## 0396 Alpha squares with marking holes

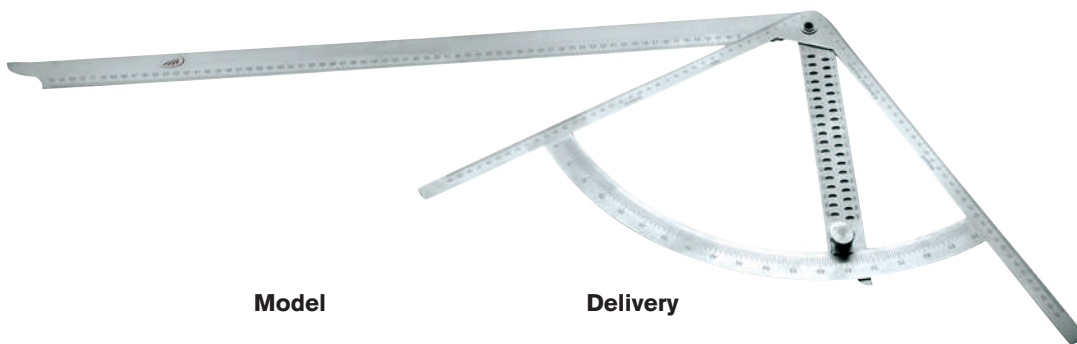

### Model

- Stainless steel
- Long blade with mm graduation, short blade used as adjustable protractor and for marking and production of wood joints 0°-90°

### Delivery

- Cardboard box

Marked	Weight	Jaw length mm	Cross-section mm	Order no.	List price EUR
		430 x 795	35	0396 290	96.00



## 0396 Joiner squares with mitre

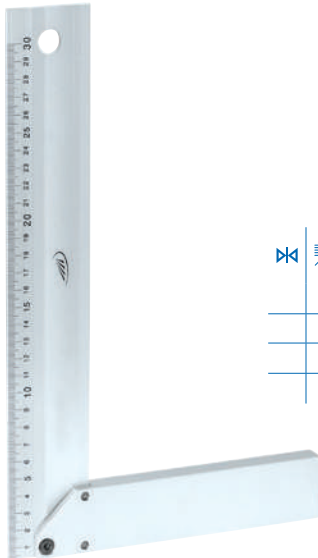



### Model

- Aluminium
- mm graduation

### Delivery

- Cardboard box

 	Jaw length mm	Cross section with narrow beam mm	Cross section with wide beam mm	Order no.	List price EUR
	250 x 148	40 x 14	50 x 5	0396 982	11.90
	300 x 164	40 x 14	50 x 5	0396 983	14.10
	400 x 195	40 x 14	50 x 5	0396 984	16.80

## 0396 Adjustable square





### Model

- Special steel, zinc coated
- Satin chrome finished
- Screw hinge
- For transferring, marking and setting of individual angles

### Delivery

- Cardboard box

 	Jaw length mm	Cross-section mm	Order no.	List price EUR
	200	20 x 8	0396 432	9.80
	250	25 x 8	0396 433	12.10
	300	25 x 8	0396 434	14.80
	400	25 x 8	0396 435	19.00
	500	25 x 8	0396 436	21.20



## 0003 Wooden cases for squares



	Jaw length mm	Internal dimensions L x W x H mm	Order no.	List price EUR
<b>For squares with base</b>				
	150 x 100	160 x 105 x 27	0003 284	6.80
	200 x 130	210 x 135 x 34	0003 286	9.00
	250 x 165	260 x 170 x 38	0003 288	19.30
	300 x 200	312 x 205 x 42	0003 290	19.30
	400 x 265	412 x 270 x 48	0003 292	36.80
	500 x 330	512 x 335 x 54	0003 294	41.50
<b>For flat type squares</b>				
	150 x 100	160 x 105 x 22	0003 283	6.10
	200 x 130	210 x 135 x 27	0003 285	7.70
	250 x 165	260 x 170 x 27	0003 287	8.50
	300 x 200	312 x 205 x 27	0003 289	11.60
	400 x 265	412 x 270 x 27	0003 291	33.30
	500 x 330	512 x 335 x 27	0003 293	37.10
<b>For squares with and without base</b>				
	50 x 40	55 x 45 x 22	0003 280	4.30
	75 x 50	80 x 55 x 22	0003 281	4.70
	100 x 70	105 x 75 x 22	0003 282	4.90



## 0411 Protractors



### Model

- Locking screw
- High precision, laser graduated degree scale
- Factory standard
- 0 - 180°

### Delivery

- Cardboard box

☒ ☒	Jaw length	Graduated arc dia.	Order no.	List price
	mm	mm		EUR
<b>Special steel</b>				
	120	80	0411 101	22.60
	150	120	0411 102	28.20
	200	150	0411 103	35.40
	300	200	0411 104	46.90
	500	300	0411 105	71.00
	600	300	0411 106	82.00
	800	300	0411 107	108.00
	600	400	0411 108	140.00
	800	400	0411 109	148.00
	1000	400	0411 110	154.00
<b>Special steel, satin chrome finished graduated arc</b>				
	120	80	0411 301	25.10
	150	120	0411 302	32.30
	200	150	0411 303	35.90
	300	200	0411 304	52.00
	500	300	0411 305	103.00
	600	300	0411 306	130.00
	800	300	0411 307	141.00
	600	400	0411 308	147.00
	800	400	0411 309	155.00
	1000	400	0411 310	191.00

## 0412 Protractors



### Model

- Locking screw
- Stainless steel
- Factory standard
- 0 - 180°
- High precision, laser graduated degree scale

### Delivery

- Cardboard box

☒ ☒	Jaw length	Graduated arc dia.	Order no.	List price
	mm	mm		EUR
	120	80	0412 201	35.40
	150	120	0412 202	38.30
	200	150	0412 203	39.40
	300	200	0412 204	55.00



## 0413 Protractors



0413 301



0413 302

### Model

- Locking screw
- Special steel
- Factory standard
- 0 - 180°
- High precision, laser graduated degree scale
- Graduated in opposite directions
- Satin chrome finished

### Delivery

- Cardboard box

	Dimensions	Jaw length	Order no.	List price
	mm			EUR
	Ø 85	150	0413 301	23.90
	85 x 50	150	0413 302	24.90

## 0415 Bevel protractors

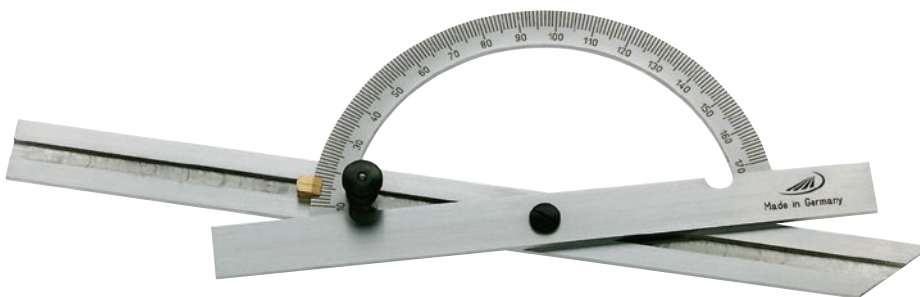

### Model

- Locking screw
- Special steel, pointer arm is satin chrome finished
- Factory standard
- Adjustable stop bar 10° - 170°
- High precision, laser graduated degree scale

### Delivery

- Cardboard box

	Jaw length	Graduated arc dia.	Order no.	List price
	mm	mm		EUR
	150	100	0415 301	65.00
	300	150	0415 302	101.00
	400	200	0415 303	137.00
	500	250	0415 304	188.00
	600	300	0415 305	213.00



## 0416 Bevel protractors with double stop rail



### Model

- Locking screw
- Special steel, pointer arm is satin chrome finished
- Factory standard
- Adjustable stop bar 10° - 170°
- High precision, laser graduated degree scale
- Two-way adjustable stop bar

### Delivery

- Cardboard box

✕	☒	Jaw length	Graduated arc dia.	Order no.	List price
		mm	mm		EUR
		150	100	0416 301	130.00
		300	150	0416 302	170.00
		400	200	0416 303	220.00
		500	250	0416 304	364.00
		600	300	0416 305	422.00

## 0422 Universal bevel protractors with magnifying lens



### Model

- Locking screw
- Stainless steel
- Factory standard
- Fine adjustment screw
- Parallax-free reading
- Reading parts are satin chrome finished

- Vernier and scale reading 5 minutes
- Hardened beam

### Delivery

- Wooden case

5

✕	☒	Measuring range	Blade length	Order no.	List price
		in °	mm		EUR
		4 x 90°	150	0422 501	151.00
		4 x 90°	200	0422 502	159.00
		4 x 90°	300	0422 503	168.00
		4 x 90°	500	0422 504	176.00



### Accessories

	Order no.	List price
		EUR
Replacement magnifying lens	0442 590	19.50



## 0425 DIGI-MET® Universal bevel protractors



### Model

- Clamping unit
- Stainless steel
- Factory standard
- Reversible measuring range:
  - 1 x 360°
  - 2 x 180°
  - 4 x 90°
- Reversible indication
  - degree and minutes
  - decimal degree

### Functions

- ON / OFF
- Set to zero at any point
- Data output Opto RS 232

### Delivery

- Wooden case

✂	☒	Blade length mm	Reading mm	Order no.	List price EUR
		150	0.01° or 1'	0425 701	1177.00
		200	0.01° or 1'	0425 702	1188.00
		300	0.01° or 1'	0425 703	1198.00

### Accessories



0996701

0996705

Accessories	Order no.	List price EUR
Battery, 3V-Lithium, CR 2032	0220 704	3.90
data cable opto to RS232	0996 701	77.00
data cable opto to USB	0996 705	147.00

## 0425 Replacement blades for 0422 / 0425



✂	☒	Blade length mm	Order no.	List price EUR
		150	0425 211	28.70
		200	0425 212	32.30
		300	0425 213	36.20
		500	0425 214	51.00



## 0420 Universal bevel protractors



### Model

- Locking screw
- Stainless steel
- Factory standard
- Vernier scale reading 5 minutes

### Delivery

- Cardboard box

Measuring range in °	Blade length mm	Order no.	List price EUR
4 x 90 °	150	0420 201	56.00
4 x 90 °	200	0420 202	60.00
4 x 90 °	300	0420 203	65.00

### Accessories

Accessories	Order no.	List price EUR
Replacement magnifying lense	0420 121	16.30
Angle stop for bevel protractors	0420 122	63.00
Prismatic base	0420 124	89.00
Replacement blade 150 mm	0420 206	18.40
Replacement blade 200 mm	0420 207	19.30
Replacement blade 300 mm	0420 208	19.50



0420121



0420122



0420124



0420206

5





# SAMPLES GAUGES

## PLUG GAUGES

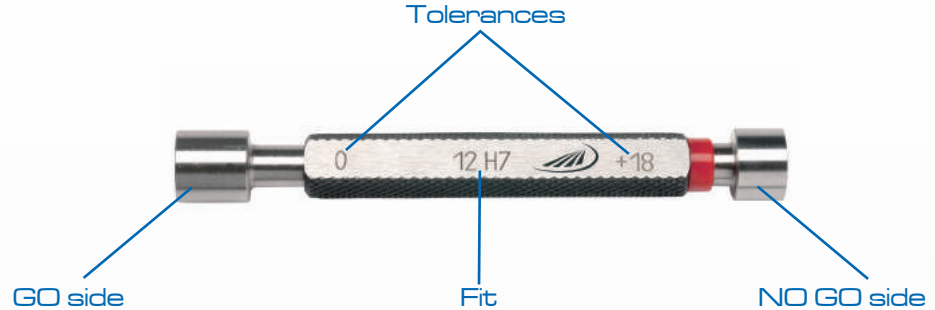

### OUR SPECIAL OFFER:

**PLUG GAUGES WITH REQUIRED FIT  
OR INDIVIDUAL TOLERANCES  
ACCORDING TO YOUR SPECIFICATIONS**

### BESTSELLER:

**FEELER GAUGE TAPES IN  
SINGLE BOXES**



NOW AVAILABLE FROM **STAINLESS STEEL**



AS **SET** IN OUR CONVENIENT **WALLHOLDER**

Incl. holder for feeler gauge tapes



## **6. CHAPTER GAUGES, RULES INSPECTION EQUIPMENT**

218	Graduated rules
221	Steel scale tapes for circumference and diameter
222	Rules
225	Knife edge rules
226	Inspection plates made from cast iron
228	Measuring and inspection plates made from granite
229	Lapping and inspection plate
229	Angle normal
230	Sinus rules, prisms
236	Sets of parallel blocks
237	Levels
239	Profile gauges, ISO indicators
242	Twist drill grinding and inspection gauges
243	Grinding / Welding gauges
244	Radius / Chamfer gauge
245	Tapered hole gauges
246	Hole gauges
247	Radius gauges
248	Feeler gauges
250	Feeler gauge tapes
252	Comparative surface roughness standards
253	Feeler gauge tapes and precision reference sheets
255	Gauge blocks and accessories
266	Pin gauges
268	Plug gauges, snap gauges
271	Plug gauges with special dimensions



## 0460 Flexible steel rules



0460 204



0460 222



0460 242

### Model

- Stainless spring band steel
- EC grade II
- Rules with special graduations or other scales are available upon request

	Length mm	Cross-section mm	Order no.	List price EUR
<b>Scales: mm top and bottom</b>				
	150	13 x 0.5	0460 201	1.10
	200	13 x 0.5	0460 202	1.10
	300	15 x 0.5	0460 204	1.60
	500	20 x 0.5	0460 205	4.30
	1000	20 x 0.5	0460 206	9.20
	300	30 x 1.0	0460 207	3.20
	500	30 x 1.0	0460 208	7.70
	1000	30 x 1.0	0460 209	16.00
	1500	30 x 1.0	0460 210	25.80
	2000	30 x 1.0	0460 211	31.10
	3000	30 x 1.0	0460 212	72.00
▪	3000	30 x 2.0	0460 213	111.00
<b>Scales: 1/2 mm top, mm bottom</b>				
	150	13 x 0.5	0460 221	1.10
	200	13 x 0.5	0460 222	1.10
	250	15 x 0.5	0460 223	1.60
	300	15 x 0.5	0460 224	1.60
	500	20 x 0.5	0460 225	4.30
	1000	20 x 0.5	0460 226	9.20
	300	30 x 1.0	0460 227	3.20
	500	30 x 1.0	0460 228	7.70
	1000	30 x 1.0	0460 229	16.00
	1500	30 x 1.0	0460 230	25.80
	2000	30 x 1.0	0460 231	31.10
	3000	30 x 1.0	0460 232	72.00
▪	3000	30 x 2.0	0460 233	111.00
<b>Scales: 1/16", 1/32", 1/64" top; 1/2 mm, 1/1 mm bottom</b>				
	150	13 x 0.5	0460 241	1.10
	200	13 x 0.5	0460 242	1.10
	250	15 x 0.5	0460 243	1.60
	300	15 x 0.5	0460 244	1.60
	500	20 x 0.5	0460 245	4.30
	1000	20 x 0.5	0460 246	9.20
	300	30 x 1.0	0460 247	3.20
	500	30 x 1.0	0460 248	7.70
	1000	30 x 1.0	0460 249	16.00
	1500	30 x 1.0	0460 250	25.80
	2000	30 x 1.0	0460 251	31.10
	3000	30 x 1.0	0460 252	72.00
▪	3000	30 x 2.0	0460 253	111.00



## 0460 Flexible steel rules, satin chrome



0460 502



0460 522

### Model

- Stainless spring band steel
- Scales satin chrome finished
- EC grade II

		Length mm	Cross-section mm	Order no.	List price EUR
<b>Scales: mm top and bottom</b>					
		150	13 x 0.5	0460 501	2.70
		200	13 x 0.5	0460 502	4.30
		300	15 x 0.5	0460 504	4.90
		500	20 x 0.5	0460 505	10.70
		1000	20 x 0.5	0460 506	21.80
		300	30 x 1.0	0460 507	5.60
		500	30 x 1.0	0460 508	11.80
		1000	30 x 1.0	0460 509	24.60
	▪	1500	35 x 1.5	0460 510	72.00
	▪	2000	35 x 1.5	0460 511	113.00
	▪	3000	35 x 1.3	0460 512	237.00
<b>Scales: 1/2 mm top, mm bottom</b>					
		150	13 x 0.5	0460 521	2.70
		200	13 x 0.5	0460 522	4.30
		300	15 x 0.5	0460 524	4.90
		500	20 x 0.5	0460 525	10.70
		1000	20 x 0.5	0460 526	21.80
		300	30 x 1.0	0460 527	5.60
		500	30 x 1.0	0460 528	11.80
		1000	30 x 1.0	0460 529	24.60

## 0453 Aluminium straight edges, anodized



0453 422

### Model

- Bevelled edge
- Non-glare mm graduation
- Factory standard

		Length mm	Cross-section mm	Order no.	List price EUR
		300	50 x 5	0453 422	8.90
		600	50 x 5	0453 430	13.20
		1000	50 x 5	0453 434	19.50



## 0451 Graduated straight rules acc. to DIN 866, type A



DIN  
866-A

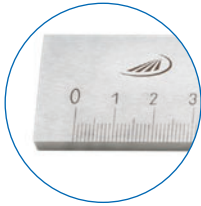

### Model

- Both-sided 10 mm protective ends
- mm graduated scale

### Delivery

- Cardboard box
- From 2000 mm in transportation box

	Length mm	Cross-section mm	Order no.	List price EUR
<b>Special steel</b>				
	500	30 x 6	0451 101	25.80
	1000	40 x 8	0451 102	59.00
▪	1500	40 x 8	0451 103	106.00
▪	2000	50 x 10	0451 104	147.00
▪	3000	50 x 10	0451 105	304.00
▪	4000	60 x 12	0451 106	552.00
<b>Stainless steel</b>				
	500	30 x 6	0451 201	45.70
	1000	40 x 8	0451 202	105.00
▪	1500	40 x 8	0451 203	156.00
▪	2000	50 x 10	0451 204	274.00
▪	3000	50 x 10	0451 205	552.00
▪	4000	60 x 12	0451 206	998.00

## 0452 Graduated straight rules acc. to DIN 866, type B



DIN  
866-B

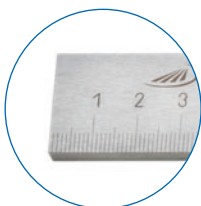

### Model

- Graduated scale begins directly on the end of rule, the other end has a 10 mm protective end
- mm graduated scale

### Delivery

- Cardboard box
- From 2000 mm in transportation box

	Length mm	Cross-section mm	Order no.	List price EUR
<b>Special steel</b>				
	500	25 x 5	0452 101	20.30
	1000	30 x 6	0452 103	40.10
▪	1500	30 x 6	0452 104	58.00
▪	2000	40 x 8	0452 105	95.00
▪	2500	40 x 8	0452 106	150.00
▪	3000	40 x 8	0452 107	166.00
▪	4000	50 x 10	0452 108	317.00
▪	5000	60 x 12	0452 109	570.00
<b>Stainless steel</b>				
	500	25 x 5	0452 201	27.10
	1000	30 x 6	0452 203	59.00
▪	1500	30 x 6	0452 204	101.00
▪	2000	40 x 8	0452 205	160.00
▪	2500	40 x 8	0452 206	306.00
▪	3000	40 x 8	0452 207	318.00
▪	4000	50 x 10	0452 208	572.00
▪	5000	60 x 12	0452 209	1090.00





## 0458 Steel scale tapes for circumference and diameter



0458 104



0458 102

### Model

- Factory standard
- Vernier 0.1 mm
- Main scale graduation 1 mm

### Delivery

- Cardboard box

For circumference mm	For dia. mm	Order no.	List price EUR
<b>Spring band steel</b>			
60 - 950	20 - 300	0458 102	38.30
940 - 2200	300 - 700	0458 103	45.70
2190 - 3460	700 - 1100	0458 104	59.00
3450 - 4720	1100 - 1500	0458 105	71.00
4710 - 5980	1500 - 1900	0458 106	85.00
5960 - 7230	1900 - 2300	0458 107	98.00
7220 - 8500	2300 - 2700	0458 108	242.00
8480 - 9760	2700 - 3100	0458 109	259.00
9730 - 11010	3100 - 3500	0458 110	333.00
11000 - 12260	3500 - 3900	0458 111	511.00
12250 - 13500	3900 - 4300	0458 112	521.00
13500 - 14760	4300 - 4700	0458 113	531.00
<b>Stainless spring band steel</b>			
60 - 950	20 - 300	0458 202	68.00
940 - 2200	300 - 700	0458 203	86.00
2190 - 3460	700 - 1100	0458 204	105.00
3450 - 4720	1100 - 1500	0458 205	139.00
4710 - 5980	1500 - 1900	0458 206	168.00

## 0458 Interior circumference tapes



### Model

- To measure the internal circumference and the mean diameter of a round, oval or a continuous polygon bore
- Main scale graduation 1 mm

### Delivery

- Cardboard box

For circumference mm	For dia. mm	Order no.	List price EUR
720 - 1550	230 - 490	0458 252	307.00
940 - 2200	300 - 700	0458 253	323.00
2190 - 3620	700 - 1100	0458 254	344.00
3450 - 4720	1100 - 1500	0458 255	396.00
4710 - 5980	1500 - 1900	0458 256	432.00

### Accessories

Expanding collet

### Order no.

0458 291

### List price EUR

431.00



## 0454 Straight edges, with bevelled edge



### Model

- Special steel
- Zinc coated
- Factory standard

### Delivery

- Cardboard box
- From 2000 mm in transportation box

	☒ ☒	Length mm	Cross-section mm	Order no.	List price EUR
		400	40 x 5	0454 424	9.40
		500	40 x 5	0454 428	11.70
	▪	1000	40 x 5	0454 434	23.20
	▪	1500	40 x 5	0454 438	42.20
	▪	2000	40 x 5	0454 440	64.00
	▪	3000	50 x 8	0454 444	169.00

## 0455 Straight edges with bevelled edge, mm graduation



### Model

- Special steel
- Zinc coated
- Factory standard
- Graduated scale begins directly on the end of rule, the other end has a 10 mm protective end

### Delivery

- Cardboard box
- From 2000 mm in transportation box

	☒ ☒	Length mm	Cross-section mm	Order no.	List price EUR
		400	40 x 5	0455 424	17.30
		500	40 x 5	0455 428	21.60
	▪	1000	40 x 5	0455 434	41.00
	▪	1500	40 x 5	0455 438	73.00
	▪	2000	40 x 5	0455 440	107.00
	▪	3000	50 x 8	0455 444	226.00



## 0464 Steel rules made of special steel, accuracy grade 0



rectangular cross section

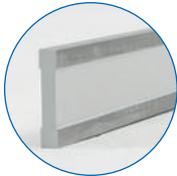

I shaped cross section, 2 hand slots

### Model

- Special steel
- Measuring surfaces are finely grinded
- Flatness of measuring surfaces according to DIN 874

### Delivery

- Cardboard box
- From 2000 mm in transportation box

		Length mm	Cross-section mm	Order no.	List price EUR
<b>Special steel, rectangular cross section</b>					
		500	50 x 10	0464 101	66.00
		750	50 x 10	0464 102	94.00
		1000	60 x 12	0464 103	147.00
	▪	1500	70 x 15	0464 104	248.00
<b>Special steel, I shaped cross section, 2 hand slots</b>					
	▪	2000	80 x 15	0464 105	445.00
	▪	2500	100 x 16	0464 106	756.00
	▪	3000	120 x 20	0464 107	1161.00
	▪	4000	140 x 20	0464 108	1995.00

## 0465 Steel rules made of special steel, accuracy grade 1



		Length mm	Cross-section mm	Order no.	List price EUR
<b>Special steel, rectangular cross section</b>					
		500	40 x 8	0465 101	32.30
		750	50 x 10	0465 102	53.00
		1000	50 x 10	0465 103	72.00
	▪	1500	60 x 12	0465 104	132.00
<b>Special steel, I shaped cross section, 2 hand slots</b>					
	▪	2000	70 x 15	0465 105	268.00
	▪	2500	80 x 15	0465 106	502.00
	▪	3000	100 x 16	0465 107	862.00
	▪	4000	120 x 20	0465 108	1393.00

## 0466 Steel rules made of special steel, accuracy grade 2



		Length mm	Cross-section mm	Order no.	List price EUR
<b>Special steel, rectangular cross section</b>					
		500	30 x 6	0466 101	22.20
		750	40 x 8	0466 102	39.00
		1000	40 x 8	0466 103	44.40
	▪	1500	50 x 10	0466 104	85.00
	▪	2000	60 x 12	0466 105	116.00
	▪	2500	70 x 15	0466 106	256.00
	▪	3000	80 x 15	0466 107	400.00
<b>Special steel, I shaped cross section, 2 hand slots</b>					
	▪	4000	100 x 16	0466 108	951.00
	▪	5000	120 x 20	0466 109	1433.00





## 0464 Steel rules made of stainless steel, accuracy grade 0



rectangular cross section



I shaped cross section, 2 hand slots

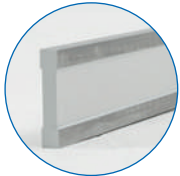

### Model

- Special steel
- Measuring surfaces are finely grinded
- Flatness of measuring surfaces according to DIN 874

### Delivery

- Cardboard box
- From 2000 mm in transportation box

		Length mm	Cross-section mm	Order no.	List price EUR
<b>Stainless steel, rectangular cross section</b>					
		500	50 x 10	0464 201	104.00
		750	50 x 10	0464 202	142.00
		1000	60 x 12	0464 203	268.00
	▪	1500	70 x 15	0464 204	445.00
<b>Stainless steel, I shaped cross section, 2 hand slots</b>					
	▪	2000	80 x 15	0464 205	823.00
	▪	2500	100 x 16	0464 206	1433.00
	▪	3000	120 x 18	0464 207	2534.00
	▪	4000	140 x 20	0464 208	4520.00

## 0465 Steel rules made of stainless steel, accuracy grade 1



		Length mm	Cross-section mm	Order no.	List price EUR
<b>Stainless steel, rectangular cross section</b>					
		500	40 x 8	0465 201	59.00
		750	50 x 10	0465 202	91.00
		1000	50 x 10	0465 203	164.00
	▪	1500	60 x 12	0465 204	256.00
<b>Stainless steel, I shaped cross section, 2 hand slots</b>					
	▪	2000	70 x 15	0465 205	604.00
	▪	2500	80 x 15	0465 206	920.00
	▪	3000	100 x 16	0465 207	1772.00
	▪	4000	120 x 18	0465 208	2610.00

## 0466 Steel rules made of stainless steel, accuracy grade 2



		Length mm	Cross-section mm	Order no.	List price EUR
<b>Stainless steel, rectangular cross section</b>					
		500	30 x 6	0466 201	38.30
		750	40 x 8	0466 202	67.00
		1000	40 x 8	0466 203	98.00
	▪	1500	50 x 10	0466 204	204.00
	▪	2000	60 x 12	0466 205	344.00
	▪	2500	70 x 15	0466 206	572.00
	▪	3000	80 x 15	0466 207	817.00
<b>Stainless steel, I shaped cross section. 2 hand slots</b>					
	▪	4000	100 x 16	0466 208	1521.00
	▪	5000	120 x 18	0466 209	2280.00





## 0512 Knife edge rules



0512 101

**DIN  
874**

### Model

- DIN 874 Sheet 2, accuracy grade 00
- Thermally insulated
- Pointed tip at one end
- Special steel: glare free and burnished knife edge
- Stainless steel: non glare knife edge

### Delivery

- Up to 500 mm in imitation leather case. From 500 mm individually packed

		Length mm	Cross-section mm	Order no.	List price EUR
<b>Special steel, hardened and grinded</b>					
		75	25 x 5	0512 101	10.50
		100	25 x 5	0512 102	11.80
		125	25 x 5	0512 103	13.30
		150	25 x 5	0512 104	15.10
		200	29 x 7	0512 105	19.70
		300	29 x 7	0512 106	37.10
		400	33 x 10	0512 107	66.00
		500	33 x 10	0512 108	104.00
<b>Stainless steel, hardened and grinded</b>					
		75	25 x 5	0512 201	13.70
		100	25 x 5	0512 202	16.00
		125	25 x 5	0512 203	16.70
		150	25 x 5	0512 204	18.70
		200	29 x 7	0512 205	21.60
		300	29 x 7	0512 206	46.90
		400	33 x 10	0512 207	85.00
		500	33 x 10	0512 208	116.00
		600	45 x 10	0512 209	224.00
		750	60 x 12	0512 210	454.00
		1000	60 x 12	0512 211	595.00

## 0512 Wooden cases for knife edge rules



		Length mm	Order no.	List price EUR
		75	0512 601	5.40
		100	0512 602	5.40
		125	0512 603	5.40
		150	0512 604	6.50
		200	0512 605	7.60
		300	0512 606	8.60
		400	0512 607	10.80
		500	0512 608	16.30
		600	0512 609	16.30
		750	0512 610	32.50
		1000	0512 611	37.90



## 0467 Mounting straight edges



DIN  
874

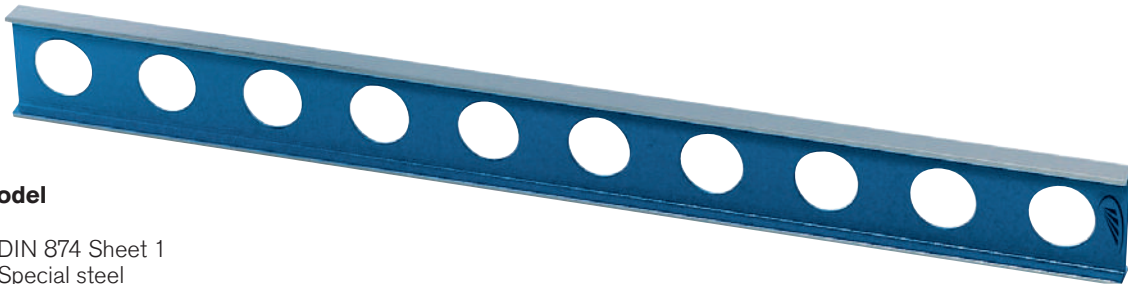

### Model

- DIN 874 Sheet 1
- Special steel
- Tolerance 21 µm

	Length mm	Cross-section mm	Order no.	List price EUR
<b>Accuracy grade 0</b>				
	1000	160 x 50	0467 011	647.00
▪	1500	160 x 50	0467 012	925.00
▪	2000	160 x 50	0467 013	1205.00
▪	2500	160 x 50	0467 014	1552.00
▪	3000	180 x 60	0467 015	2597.00
▪	4000	180 x 60	0467 016	3609.00
▪	5000	200 x 80	0467 017	6266.00
<b>Accuracy grade 1</b>				
	1000	100 x 30	0467 111	476.00
▪	1500	100 x 30	0467 112	642.00
▪	2000	120 x 40	0467 113	857.00
▪	2500	120 x 40	0467 114	1172.00
▪	3000	140 x 40	0467 115	1579.00
▪	4000	140 x 40	0467 116	2078.00
▪	5000	140 x 40	0467 117	3293.00

## 0478 Inspection plates



DIN  
876-2

### Model

- Special cast iron
- Rigid ripped construction
- milled

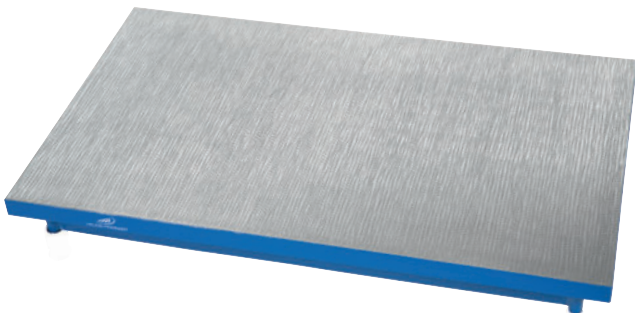

	Base dimensions mm	Accuracy grade	Order no.	List price EUR
<b>Grinded</b>				
	200 x 200	3	0478 312	101.00
	300 x 300	3	0478 315	162.00
▪	400 x 300	3	0478 316	195.00
▪	400 x 400	3	0478 317	233.00
▪	500 x 400	3	0478 318	301.00
▪	500 x 500	3	0478 319	446.00
▪	600 x 500	3	0478 321	491.00
▪	800 x 500	3	0478 324	701.00
▪	1000 x 600	3	0478 327	1114.00



## 0478 Inspection plates



DIN  
876-2

### Model

- Flatness in accordance to DIN 876-2
- Special cast iron
- Rigid construction

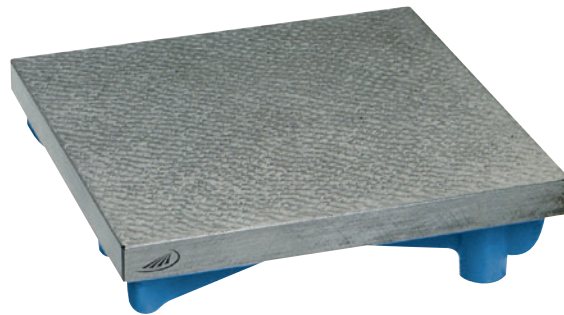

Icon	Base dimensions mm	Accuracy grade	Order no.	List price EUR
<b>Scraped</b>				
	200 x 200	0	0478 012	172.00
	300 x 300	0	0478 015	301.00
▪	400 x 300	0	0478 016	379.00
▪	400 x 400	0	0478 017	491.00
<b>Microground</b>				
▪	200 x 200	1	0478 112	135.00
▪	300 x 300	1	0478 115	223.00
▪	400 x 300	1	0478 116	301.00
▪	400 x 400	1	0478 117	379.00
▪	500 x 400	1	0478 118	423.00
▪	500 x 500	1	0478 119	546.00
▪	600 x 500	1	0478 121	602.00
▪	800 x 500	1	0478 124	1002.00
▪	1000 x 600	1	0478 127	1782.00

## 0478 Base stand for inspection plates



6



Icon	For plate size mm	Order no.	List price EUR
	400 x 400	0478 907	287.00
	500 x 400	0478 908	287.00
	500 x 500	0478 909	307.00
▪	600 x 500	0478 911	323.00
▪	800 x 500	0478 914	365.00
▪	1000 x 600	0478 917	438.00



## 0481 Measuring and inspection plates



### Model

- Flatness in accordance to DIN 876-1
- Granite
- Acid resistant
- Steel ball inserts

### Delivery

- Without base stand (option)

DIN  
876-1

✕	☒	Base dimensions mm	Order no.	List price EUR
<b>Accuracy grade 00</b>				
	▪	400 x 400 x 50	0481 023	315.00
	▪	500 x 400 x 90	0481 024	455.00
	▪	600 x 500 x 100	0481 025	685.00
	▪	800 x 600 x 120	0481 028	1137.00
	▪	1000 x 600 x 140	0481 030	1298.00
	▪	1200 x 800 x 160	0481 034	2142.00
<b>Accuracy grade 0</b>				
	▪	400 x 400 x 50	0481 043	268.00
	▪	500 x 400 x 90	0481 044	391.00
	▪	600 x 500 x 100	0481 045	580.00
	▪	800 x 600 x 120	0481 048	974.00
	▪	1000 x 600 x 140	0481 050	1235.00
	▪	1200 x 800 x 160	0481 054	1947.00
<b>Accuracy grade 1</b>				
	▪	400 x 400 x 50	0481 103	229.00
	▪	500 x 400 x 90	0481 104	332.00
	▪	600 x 500 x 100	0481 105	506.00
	▪	800 x 600 x 120	0481 108	844.00
	▪	1000 x 600 x 140	0481 110	1123.00
	▪	1200 x 800 x 160	0481 114	1787.00

## 0481 Base stand for surface and inspection plates



✕	☒	For plate size mm	Order no.	List price EUR
		400 x 400	0481 160	353.00
		500 x 400	0481 161	366.00
	▪	600 x 500	0481 162	386.00
	▪	800 x 600	0481 165	412.00
	▪	1000 x 600	0481 167	431.00
	▪	1200 x 800	0481 170	490.00



## 0481 Cabinet for measuring and inspection plates



### Model

- Frame is made of angled steel and is completely panelled with steel
- Adjustable 3 point bearing fitting
- 2 adjustable screws for stability
- Lockable doors
- Shelves are removable
- Feet are adjustable to compensate for unevenness of the floor
- 1 door, 1 shelf

☒	☒	For plate size mm	Description	Order no.	List price EUR
	▪	600 x 500	1 door, 1 shelf	0481 184	1144.00
	▪	800 x 600	1 door, 1 shelf	0481 186	1260.00
	▪	1000 x 600	2 doors, 1 drawer, 1 shelf	0481 188	1308.00
	▪	1200 x 800	2 doors, 1 drawer, 1 shelf	0481 190	1462.00

## 0482 Lapping and inspection plate

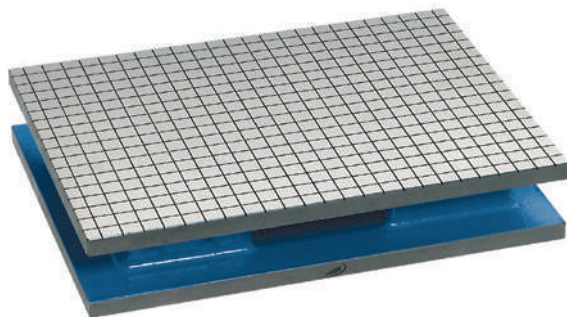

### Model

- High grade cast iron
- Finely ground
- One side for lapping with rectangular grooves
- One side as inspection plate flat straight trough

### Delivery

- Wooden case

☒	☒	Base dimensions mm	Order no.	List price EUR
	▪	360 x 260 x 65	0482 101	488.00

## 0544 Angle normal 90°, triangular



### Model

- Made of black granite
- From 600 x 400 mm with weight reducing holes

☒	☒	Length mm	Width mm	Height mm	Angle accuracy μ	Order no.	List price EUR
		150	40	200	2	0544 101	346.00
		200	50	300	2	0544 102	534.00
		250	60	400	3	0544 103	739.00
		300	60	500	3	0544 104	934.00
	▪	400	70	600	4	0544 105	1588.00
	▪	500	90	800	4	0544 106	2392.00
	▪	600	100	1000	4	0544 107	4565.00



## 0513 Sinus rules



DIN  
2273



0513 001



0513 011

### Model

- DIN 2273
- Special steel, hardened

### Delivery

- With sinus table
- Cardboard box

⌘	⚙	Roller spacing mm	Barrel distance mm	Order no.	List price EUR
<b>Without stop type B</b>					
		100	0.002	0513 001	172.00
		200	0.004	0513 002	198.00
<b>With stop type A</b>					
		100	0.002	0513 011	188.00
		200	0.004	0513 012	219.00

## 0504 V-blocks (pair)



### Model

- Special cast iron
- 90° grooves
- Machined in pairs

### Delivery

- In pairs
- Cardboard box

⌘	⚙	Base dimensions mm	For shaft dia. mm	Accuracy grade	Order no.	List price EUR
<b>Parallelism tolerance &lt; 0.008 mm, V-grooves and base finely grinded</b>						
		100 x 40 x 30	6 - 40	0	0504 012	93.00
		150 x 50 x 40	8 - 50	0	0504 013	145.00
		200 x 70 x 50	8 - 70	0	0504 014	223.00
<b>Parallelism tolerance &lt; 0.016 mm, V-grooves and base grinded</b>						
		100 x 40 x 30	6 - 40	1	0504 112	66.00
		150 x 50 x 40	8 - 50	1	0504 113	88.00
		200 x 70 x 50	8 - 70	1	0504 114	145.00
<b>Parallelism tolerance &lt; 0.064 mm, V-grooves and base milled</b>						
		100 x 40 x 30	6 - 40	3	0504 312	45.50
		150 x 50 x 40	8 - 50	3	0504 313	67.00
		200 x 70 x 50	8 - 70	3	0504 314	110.00



## 0520 V-blocks (pair)

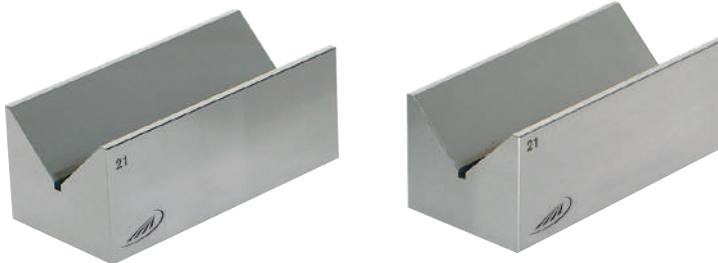

### Model

- Special steel, hardened
- Parallelism from prism to base 0.004 mm
- 90° grooves
- Machined in pairs

### Delivery

- In pairs
- Cardboard box

»	¼	Base dimensions L x W x H mm	For shaft dia. mm	Order no.	List price EUR
		75 x 35 x 30	5 - 40	0520 101	133.00
		100 x 47 x 40	5 - 55	0520 102	175.00
		150 x 55 x 45	5 - 60	0520 103	232.00
		200 x 65 x 55	5 - 75	0520 104	324.00
		250 x 85 x 70	5 - 100	0520 105	443.00

## 0508 Pair of X type V-blocks (parallel)

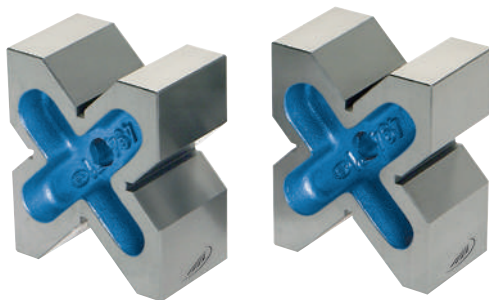

### Model

- Factory standard
- Special cast iron
- 4 x 90° grooves, different sizes
- Machined in pairs

### Delivery

- In pairs
- Cardboard box

»	¼	Base dimensions L x W x H mm	For shaft dia. mm	Accuracy grade	Order no.	List price EUR
<b>Parallelism tolerance &lt; 0.008 mm, V-grooves and base grinded</b>						
		60 x 120 x 100	8 - 90	0	0508 011	307.00
		75 x 150 x 130	8 - 130	0	0508 012	370.00
	▪	90 x 200 x 170	12 - 180	0	0508 013	542.00
<b>Parallelism tolerance &lt; 0.016 mm, V-grooves and base finely grinded</b>						
		60 x 120 x 100	8 - 90	1	0508 111	266.00
		75 x 150 x 130	8 - 130	1	0508 112	328.00
	▪	90 x 200 x 170	8 - 180	1	0508 113	500.00





## 0522 V-blocks with clamp



### Specification

- Stainless special steel, hardened
- Parallelism from prism to base 0.004 mm
- 2 x 90° grooves

### Delivery

- Cardboard box

	Dimensions L x W x H mm	For shaft dia. mm	Order no.	List price EUR
	50 x 40 x 40	5 - 30	0522 201	133.00
	75 x 55 x 55	5 - 50	0522 202	162.00
	100 x 75 x 75	7 - 70	0522 203	233.00

## 0522 Double V-blocks (pairs) with clamp



### Specification

- Stainless special steel, hardened
- Parallelism from prism to base 0.004 mm

### Delivery

- 2 x 90° grooves
- Machined in pairs
- In pairs
- Cardboard box

	Dimensions L x W x H mm	For shaft dia. mm	Order no.	List price EUR
<b>Special steel, hardened</b>				
	50 x 40 x 40	5 - 30	0522 101	204.00
	75 x 55 x 55	5 - 50	0522 102	249.00
	100 x 75 x 75	7 - 70	0522 103	359.00
<b>Stainless special steel, hardened</b>				
	50 x 40 x 40	5 - 30	0522 206	253.00
	75 x 55 x 55	5 - 50	0522 207	308.00
	100 x 75 x 75	7 - 70	0522 208	443.00



## 0524 Double V-blocks (pairs) with clamp lateral tilting



### Specification

- Stainless special steel, hardened
- Flatness, parallelism and symmetry tolerance 0.004 mm
- Right-angled tolerance faces to prism 0.01
- 2 x 90° grooves
- Machined in pairs

### Delivery

- In pairs
- Cardboard box

	☒	☒	☒	☒
		Dimensions mm	For shaft dia. mm	Order no.
		60 x 58 x 40	5 - 30	0524 101
		75 x 70 x 54	5 - 30	0524 102
		100 x 96 x 75	7 - 70	0524 103
				List price EUR
				225.00
				278.00
				418.00

## 0522 Clamp for double V-blocks



### Delivery

- In pairs
- Cardboard box

	☒	☒	☒	☒
		Suitable for prisms	Order no.	List price EUR
		0522 201 / 0522 101 / 0522 206 / 0524 101	0522 111	20.50
		0522 202 / 0522 102 / 0522 207 / 0524 102	0522 112	27.10
		0522 203 / 0522 103 / 0522 208 / 0524 103	0522 113	34.60



## 0527 Magnetic measuring and clamping prism



### Model

- Flatness, parallelism and symmetry tolerance 0.004 mm
- Right-angled tolerance is 0.01 mm
- Magnet can be switched ON/OFF
- Magnetic force 600 N

### Delivery

- Cardboard box

	Dimensions L x W x H mm	For shaft dia. mm	Order no.	List price EUR
<b>Special steel</b>				
	80 x 67 x 99	6 - 66	0527 101	340.00
	100 x 67 x 96	6 - 70	0527 102	471.00
<b>Special steel, hardened</b>				
	71,5 x 45 x 70	2 - 40	0527 106	275.00
	80 x 67 x 99	6 - 66	0527 107	403.00
	100 x 67 x 96	6 - 70	0527 108	562.00

## 0527 Magnetic measuring and clamping prism (pairs)

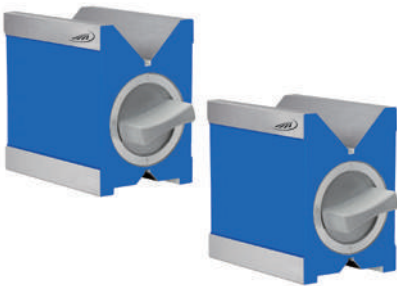

### Model

- Grinded in pairs

### Delivery

- In pairs
- Cardboard box

	Dimensions L x W x H mm	For shaft dia. mm	Order no.	List price EUR
<b>Special steel</b>				
	80 x 67 x 99	6 - 66	0527 104	668.00
	100 x 67 x 96	6 - 70	0527 105	934.00
<b>Special steel, hardened</b>				
	71,5 x 45 x 70	2 - 40	0527 109	550.00
	80 x 67 x 99	6 - 66	0527 110	858.00
	100 x 67 x 96	6 - 70	0527 111	1111.00



## 0527 Magnetic measuring and clamping prism single / pair

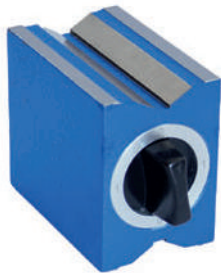

0527 151



0527 156

### Specification

- Special steel, polished
- Two sided machining
- Prisms 120°
- Parallelism from prism to base 0.008 mm
- Magnet can be switched ON/OFF
- Magnetic force 600 N

### Delivery

- Cardboard box
- Packed individually or in pairs

☒ ☒	Dimensions L x W x H mm	For shaft dia. mm	Order no.	List price EUR
<b>Single prism</b>				
	70 x 45 x 65	13 - 35	0527 151	180.00
<b>Pair of prisms</b>				
	70 x 45 x 65	13 - 35	0527 156	355.00

## 0525 Adjustable V-blocks 0-60°

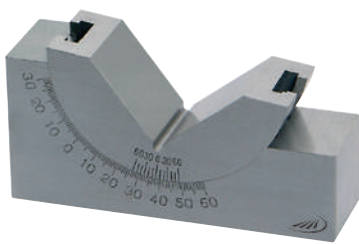

### Model

- Special steel, hardened
- Locking device
- Vernier reading

### Delivery

- Cardboard box

☒ ☒	Dimensions mm	For shaft dia. mm	Order no.	List price EUR
	75 x 25 x 33	4 - 28	0525 101	120.00
	102 x 30 x 46	4 - 40	0525 102	128.00
	102 x 46 x 46	4 - 40	0525 103	137.00



## 0536 Set of parallel blocks



0536 202



0536 211

### Model

- Special steel, hardened

### Delivery

- Wooden case

▶	☒	Measuring range mm	Height mm	Width mm	Number of devices	Height tolerance µm	Order no.	List price EUR
<b>Set consists of 9 pairs, length 100 mm</b>								
		10 - 42	10 / 14 / 18 / 22 / 26 / 30 / 34 / 38 / 42	4	9	± 5	0536 220	103.00
<b>Set consists of 9 pairs, length 150 mm</b>								
		10 - 42	10 / 14 / 18 / 22 / 26 30 / 34 / 38 / 42	4	9	± 5	0536 230	141.00
<b>Set consists of 12 pairs, length 120 mm</b>								
		14 - 40	14 / 16 / 18 / 20 22 / 24 / 26 / 28 30 / 32 / 35 / 40	10	12	± 5	0536 201	391.00
<b>Set consists of 14 pairs, length 150 mm</b>								
		14 - 50	14 / 16 / 18 / 20 22 / 24 / 26 / 28 30 / 32 / 35 / 40 45 / 50	10	14	± 5	0536 202	438.00
<b>Set consists of 20 pairs, length 100 mm</b>								
		2 - 24	5 / 10 / 15 / 20 6 / 11 / 16 / 21 7 / 12 / 17 / 22 8 / 13 / 18 / 23 9 / 14 / 19 / 24	2 3 4 5 6	20	± 5	0536 211	546.00
<b>Set consists of 24 pairs, length 125 mm</b>								
		8 - 42	11 / 16 / 21 / 26 / 31 / 36 13 / 18 / 23 / 28 / 33 / 38 15 / 20 / 25 / 30 / 35 / 40 17 / 22 / 27 / 32 / 37 / 42	8 10 12 14	24	± 5	0536 212	645.00
<b>Set consists of 24 pairs, length 150 mm</b>								
		8 - 42	11 / 16 / 21 / 26 / 31 / 36 13 / 18 / 23 / 28 / 33 / 38 15 / 20 / 25 / 30 / 35 / 40 17 / 22 / 27 / 32 / 37 / 42	8 10 12 14	24	± 5	0536 213	650.00



## 0550 Machine levels

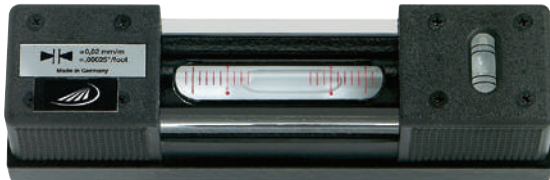

DIN 877

### Model

- DIN 877
- V-groove in the base
- Longitudinal level grinded and graduated
- Transverse level
- Thermally insulated

### Delivery

- Case

	Length mm	Order no.	List price EUR
<b>Reading 0.02 mm/m</b>			
	160	0550 021	266.00
	200	0550 022	292.00
	250	0550 023	318.00
	300	0550 024	344.00
<b>Reading 0.1 mm/m</b>			
	160	0550 101	188.00
	200	0550 102	214.00
	250	0550 103	240.00
	300	0550 104	266.00
<b>Reading 0.3 mm/m</b>			
	160	0550 131	146.00
	200	0550 132	172.00
	250	0550 133	198.00
	300	0550 134	224.00

## 0551 Crankpin levels



DIN 877

### Model

- DIN 877
- With a longitudinal and a transverse level
- Longitudinal level grinded and graduated

### Delivery

- Case

	Length mm	Order no.	List price EUR
<b>Reading 0.04 mm/m</b>			
	90	0551 002	281.00
	120	0551 003	336.00
<b>Reading 0.1 mm/m</b>			
	90	0551 012	178.00
	120	0551 013	200.00
<b>Reading 0.2 mm/m</b>			
	60	0551 021	168.00



## 0556 Frame levels



DIN  
877



### Model

- DIN 877
- V-grooves on 3 sides
- Longitudinal level
- Grinded and graduated
- Transverse level
- Thermally insulated

### Delivery

- Case

	Dimensions mm	Order no.	List price EUR
<b>Reading 0.02 mm/m</b>			
	150 x 150	0556 022	511.00
	200 x 200	0556 023	584.00
	300 x 300	0556 024	823.00
<b>Reading 0.1 mm/m</b>			
	100 x 100	0556 101	313.00
	150 x 150	0556 102	365.00
	200 x 200	0556 103	458.00
	300 x 300	0556 104	729.00
<b>Reading 0.3 mm/m</b>			
	100 x 100	0556 131	261.00
	150 x 150	0556 132	313.00
	200 x 200	0556 133	479.00
	300 x 300	0556 134	573.00

## 0560 Protractor level



### Model

- Made of special steel
- With degree scale
- Flat base
- 1° to 0-90°
- Ideal for levelling, determining centre points and adjusting angles

### Delivery

- Case

	Dimensions mm	Readings minutes	Order no.	List price EUR
<b>Reading 0.04 mm/m</b>				
	200 x 200	6	0560 001	306.00

## 0563 Magnetic angle gauge



### Model

- Centre punch
- Dial face 360°
- Magnetic 90° splayed base

### Delivery

- Cardboard box

	Order no.	List price EUR
	0563 001	417.00



## 0580 Combined lathe and thread cutting gauge



### Model

- Special steel
- Cuts for trapezoidal (Acme), Whitworth and metric threads

Icon	Dimensions	Measuring range	Order no.	List price
	mm	in °		
	90 x 40 x 2	40-80°	0580 101	7.40

## 0580 Combined lathe and thread cutting gauge

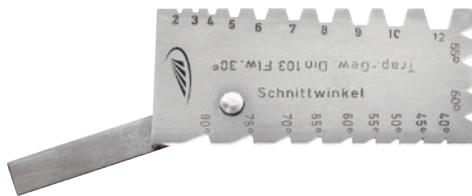

### Model

- Special steel
- Cuts for trapezoidal (Acme), Whitworth and metric threads
- With clearance angle

Icon	Dimensions	Measuring range	Order no.	List price
	mm	in °		
	90 x 40 x 2	0-30° and 40-80°	0580 111	10.70

## 0580 Combined lathe and thread cutting gauge

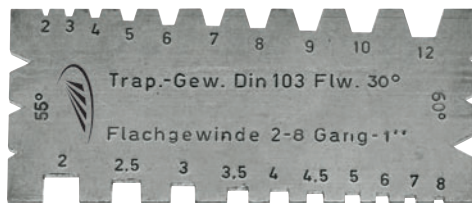

### Model

- Special steel
- For square threads and trapezoidal threads, Whitworth and metric threads

Icon	Dimensions	Order no.	List price
	mm		
	90 x 40 x 2	0580 121	7.50

## 0580 Universal thread cutting gauge

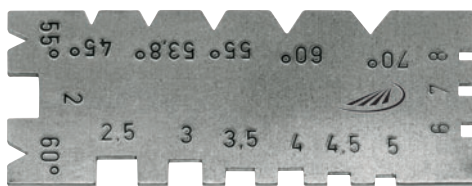

### Model

- Special steel
- For V-threads and square threads

Icon	Dimensions	Order no.	List price
	mm		
	60 x 25 x 2	0580 151	3.10





## 0595 ACME Thread gauge



### Model

- Special steel
- Cuts for trapezoidal threads



		Dimensions mm	Type of thread	Order no.	List price EUR
		60 x 20 x 2	Trapezoidal threads	0595 130	3.10

## 0595 Thread cutting gauge



### Model

- Special steel
- Cuts for Whitworth or metric threads

		Dimensions mm	Type of thread	Order no.	List price EUR
		<b>Metric ISO - threads 60°</b>			
		74 x 24 x 2	Whitworth-thread	0595 142	2.70
		<b>Whitworth - threads 55°</b>			
		74 x 24 x 2	Whitworth-thread	0595 140	2.70



## 0581 DIN thread conversion and fit slide rules



0581 101



0581 123

### Model

- For reading the most important theoretical dimensions of thread tolerance

Description	Order no.	List price EUR
<b>Aluminium anodized</b>		
Fine thread slide rule	0581 101	21.60
DIN thread slide rule	0581 103	14.60
DIN fit slide rule	0581 105	20.00
<b>Plastic</b>		
DIN thread slide rule	0581 123	10.50
DIN fit slide rule	0581 125	9.20

## 0582 ISO thread converter - Filetor



### Model

- For direct reading of all standard information for determining of threads
- Plastic housing

Dimensions mm	Order no.	List price EUR
60 x 30 x 110	0582 110	61.00

## 0582 ISO tolerance indicator - Tolerator



### Model

- For direct reading of all standard information of all ISO-tolerance values
- Plastic housing

Dimensions mm	Order no.	List price EUR
60 x 30 x 110	0582 120	61.00



## 0582 mm/inch converter



### Model

- Direct reading of inch to millimeter conversion
- Plastic housing

		Dimensions mm	Order no.	List price EUR
		60 x 30 x 110	0582 130	61.00

## 0589 Profile gauge

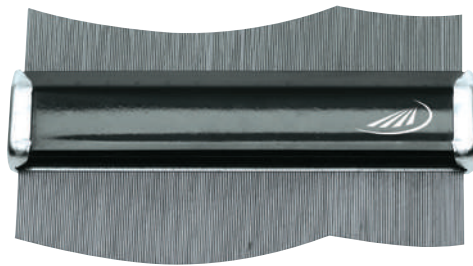

### Model

- Spring pins
- Pin-dia. 1.0 mm

		Dimensions mm	Order no.	List price EUR
		154 x 85	0589 101	16.90
		350 x 150	0589 103	52.00

## 0590 Twist drill grinding gauge



### Model

- Special steel
- For twist drills
- Acute angle of 118°

		Max dia. mm	Order no.	List price EUR
		50	0590 101	1.80

## 0590 Twist drill grinding and inspection gauge



### Model

- Special steel
- Measure the length of the cutting edge and the cutting angle of 118°
- Locking screw

		Reading mm	Max. dia. mm	Order no.	List price EUR
		0.10	50	0590 111	65.00



## 0590 Universal grinding gauge



### Model

- Special steel
- Scales in mm graduation
- Angles 120°, 118°, 90°, 60° and 55°

☒	☒	Dimensions mm	Order no.	List price EUR
		95 x 63 x 2	0590 151	3.40

## 0595 Welding gauge blank



### Model

- Special steel
- Pure
- For easy testing of fillet weld thicknesses of rectangular parts

☒	☒	For measuring range mm	Order no.	List price EUR
		3 - 12	0595 110	13.20

## 0595 Welding gauge blank

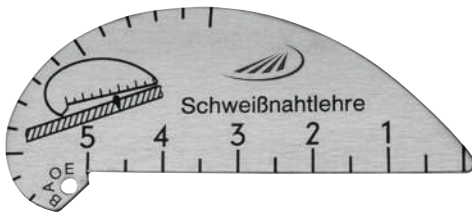

### Model

- Aluminium
- Pure, for fast reading of the weld dimensions

☒	☒	For measuring range mm	Order no.	List price EUR
		0 - 5	0595 115	3.80

## 0595 Welding gauge

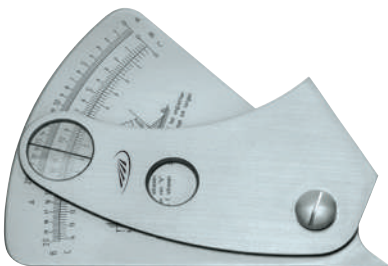

### Model

- Stainless steel
- Reading accuracy 0.2 mm
- Easy to read the result due to the reference line in the reading window
- Quick and easy inspection of welding seam heights

☒	☒	Dimensions mm	Order no.	List price EUR
		108 x 81.5 x 3.2	0595 251	91.00



## 0595 Welding gauge

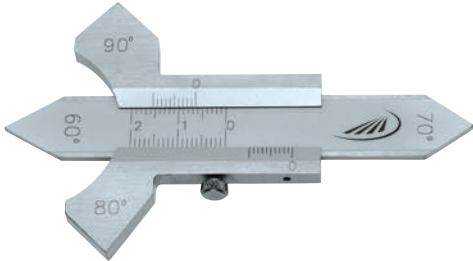

### Model

- Special steel
- Locking screw
- Angle 60°, 70°, 80° and 90°; to measure the height of flat welds and fillet weld thicknesses

	Measuring range	Reading	Order no.	List price
	mm	mm		EUR
	20	0.10	0595 101	21.20

## 0597 Radius gauge

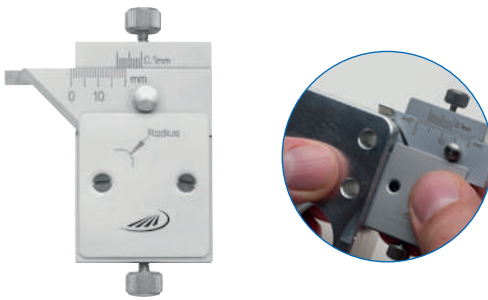

### Model

- To determine radius size work-pieces
- Stainless steel
- Reading parts are satin chrome finished

### Delivery

- Wooden case

	Measuring range	Reading	Order no.	List price
	mm	mm		EUR
	0 - 10	0.10	0597 305	175.00

## 0597 Chamfer gauge

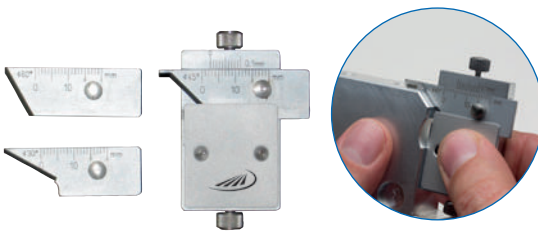

### Model

- Stainless steel
- Reading parts are satin chrome finished
- For simultaneously testing of the chamfer angle and the dimensional accuracy
- Dimensions: 48 x 30 x 8.5 mm

### Delivery

- 3 interchangeable blades: 30°, 45°, 60°

	Measuring range	Reading	Order no.	List price
	mm	mm		EUR
	0 - 10	0.10	0597 301	175.00



## 0598 Tapered hole gauges



### Model

- Special steel
- Reading parts matted

☒	☒	Measuring range mm	Reading mm	Order no.	List price EUR
<b>Special steel</b>					
		0.5 - 11	0.10	0598 101	48.80
		0.5 - 7.0	0.10	0598 103	48.80
		2.0 - 7.0	0.10	0598 105	48.80
<b>Plastic</b>					
		0.5 - 11	0.10	0598 601	48.80

## 0599 Nozzle / small hole gauges



### Model

- Special steel
- Cone 1:10
- Nickel plated housing

☒	☒	Measuring range mm	Reading mm	Order no.	List price EUR
		0 - 3	0.01	0599 101	48.80
		0 - 5	0.01	0599 102	59.00

## 0599 Nozzle gauges

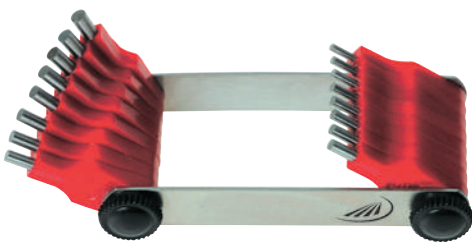

### Model

- With steel pins
- Plastic handle
- Manufacturing tolerance  $\pm 0.01$  mm

☒	☒	Measuring range mm	Increment mm	Number of pairs	Order no.	List price EUR
		0.45 - 1.5	0.05	20	0599 151	7.10
		1.5 - 3.0	0.1	16	0599 152	7.10



## 0600 Tapered hole gauges



0600 101



0600 111

### Model

- Reading 0.1 mm

Measuring range mm	Order no.	List price EUR
<b>Special steel, flat</b>		
1 - 15	0600 101	25.80
15 - 30	0600 102	32.30
30 - 45	0600 103	34.60
<b>Hardened stainless steel, satin chrome finished, round, knurled handle</b>		
1 - 6	0600 111	55.00
4 - 15	0600 112	73.00
15 - 30	0600 113	152.00
30 - 45	0600 114	237.00
45 - 60	0600 115	380.00

## 0601 Drill and steel wire hole gauges (millimeter)

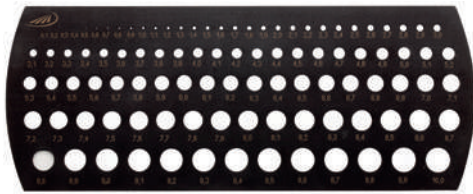

### Model

- Special steel, nitrided

Measuring range mm	Increment mm	Order no.	List price EUR
0.1 - 10	0.1	0601 103	91.00
3.0 - 10	0.1	0601 120	69.00

## 0604 Radius gauges



### Model

- Concave and convex
- Locking nut
- Milled finish

Measuring range mm	Number of blades	Order no.	List price EUR
<b>Special steel</b>			
1.0 - 7.0	17	0604 002	6.80
7.5 - 15	16	0604 004	7.50
15.5 - 25	15	0604 006	7.50
<b>Stainless steel</b>			
1.0 - 7.0	17	0604 202	9.00
7.5 - 15	16	0604 204	11.10
15.5 - 25	15	0604 206	11.10



## 0604 Precision individual radius gauges

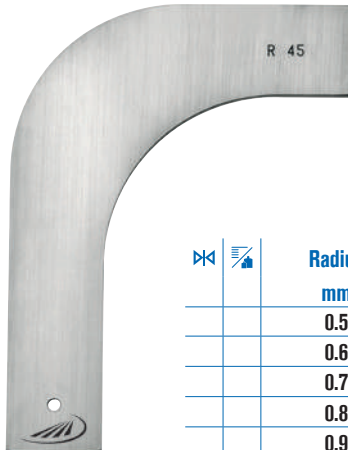

### Model

- Special steel
  - Factory standard
  - Fine grinded
  - For internal and external radii
  - Custom sizes are available upon request
- Thickness:  
R 0,5 - R 50 = 2 mm  
R 50 - R 100 = 3 mm

✕	☒	Radius mm	Order no.	List price EUR
		0.5	0604 013	53.00
		0.6	0604 014	53.00
		0.7	0604 015	53.00
		0.8	0604 016	53.00
		0.9	0604 017	53.00
		1.0	0604 018	53.00
		1.5	0604 019	53.00
		2.0	0604 020	53.00
		2.5	0604 021	53.00
		3.0	0604 022	53.00
		3.5	0604 023	53.00
		4.0	0604 024	53.00
		4.5	0604 025	34.40
		5.0	0604 026	34.40
		5.5	0604 027	34.40
		6.0	0604 028	34.40
		6.5	0604 029	34.40
		7.0	0604 030	34.40
		7.5	0604 031	34.40
		8.0	0604 032	34.40
		8.5	0604 033	34.40
		9.0	0604 034	34.40
		9.5	0604 035	34.40
		10.0	0604 036	34.40
		10.5	0604 037	36.20
		11.0	0604 038	36.20
		11.5	0604 039	36.20
		12.0	0604 040	36.20
		12.5	0604 041	36.20
		13.0	0604 042	36.20
		13.5	0604 043	36.20
		14.0	0604 044	36.20
		14.5	0604 045	36.20
		15.0	0604 046	36.20
		15.5	0604 047	38.10
		16.0	0604 048	38.10
		16.5	0604 049	38.10
		17.0	0604 050	38.10
		17.5	0604 051	38.10
		18.0	0604 052	38.10
		18.5	0604 053	38.10
		19.0	0604 054	38.10

✕	☒	Radius mm	Order no.	List price EUR
		19.5	0604 055	38.10
		20.0	0604 056	38.10
		21.0	0604 057	39.70
		22.0	0604 058	39.70
		23.0	0604 059	39.70
		24.0	0604 060	39.70
		25.0	0604 061	39.70
		26.0	0604 062	39.70
		27.0	0604 063	39.70
		28.0	0604 064	39.70
		29.0	0604 065	39.70
		30.0	0604 066	39.70
		31.0	0604 067	43.30
		32.0	0604 068	43.30
		33.0	0604 069	43.30
		34.0	0604 070	43.30
		35.0	0604 071	43.30
		36.0	0604 072	43.30
		37.0	0604 073	43.30
		38.0	0604 074	43.30
		39.0	0604 075	43.30
		40.0	0604 076	43.30
		41.0	0604 077	52.00
		42.0	0604 078	52.00
		43.0	0604 079	52.00
		44.0	0604 080	52.00
		45.0	0604 081	52.00
		46.0	0604 082	52.00
		47.0	0604 083	52.00
		48.0	0604 084	52.00
		49.0	0604 085	52.00
		50.0	0604 086	52.00
		55.0	0604 087	56.00
		60.0	0604 088	59.00
		65.0	0604 089	63.00
		70.0	0604 090	72.00
		75.0	0604 091	72.00
		80.0	0604 092	72.00
		85.0	0604 093	72.00
		90.0	0604 094	72.00
		95.0	0604 095	72.00
		100.0	0604 096	72.00





## 0605 Screw pitch gauges



☒	☒	Measuring range mm	Number of blades	Description	Order no.	List price EUR
		0.25 - 6.0	24	Metric threads according to ISO	0605 101	2.50
		0.40 - 7.0	20	Combined metric threads according to SI System	0605 102	2.30
		4.00 - 62.0	28	Whitworth threads according to DIN	0605 103	2.30
		8.00 - 28.0	6	Whitworth pipe threads	0605 104	2.30
		0.40 - 7.0 / 4.0 - 62.0	48	Combined metric SI and Whitworth threads	0605 105	3.40
		0.25 - 6.0 / 4.0 - 62.0	52	Combined metric and Whitworth	0605 106	3.60
		0.25 - 6.0 / 4.0 - 62.0 / 8.0 - 28.0	58	Metric Whitworth and pipe threads	0605 107	5.10
		4.00 - 42.0	30	US - threads	0605 108	3.00
		10.0 - 40.0	14	US - threads SAE	0605 109	3.20
		4.00 - 64.0	22	UNC - threads	0605 110	3.00
		12.0 - 80.0	16	UNF - threads	0605 111	3.00
		4.00 - 26.0	20	BSF - threads	0605 112	3.40

## 0606 / 0607 Feeler gauges



0606 121



0607 201



0607 401

### Model

- Conical blades
- Width 10mm
- Blade length 100
- Locking nut

☒	☒	Measuring range mm	Number of blades	Order no.	List price EUR
<b>Spring band steel</b>					
		0.03 - 0.1	8	0606 121	1.60
		0.05 - 0.5	8	0606 123	1.60
		0.05 - 1.0	13	0606 127	1.60
		0.05 - 1.0	20	0606 130	2.50
		0.1 - 2.0	20	0606 131	6.10
		0.1 - 0.5	21	0606 132	3.00
		0.05 - 2.0	21	0606 133	5.60
		0.03 - 1.0	32	0606 136	5.10
<b>Stainless spring band steel</b>					
		0.05 - 0.5	8	0607 201	3.90
		0.05 - 1.0	13	0607 202	6.10
		0.05 - 1.0	20	0607 203	8.80
<b>Brass (anti-magnetic)</b>					
		0.05 - 0.5	8	0607 401	6.60
		0.05 - 1.0	13	0607 402	8.10
		0.05 - 1.0	20	0607 403	11.60



## 0606 Feeler gauges, long version



### Model

- Cylindrical blades
- Width 13 mm

Measuring range mm	Length mm	Number of blades	Order no.	List price EUR
0.05 - 0.5	150	8	0606 150	3.40
0.05 - 0.5	200	8	0606 152	4.10
0.05 - 0.5	300	8	0606 154	5.90
0.05 - 1.0	200	13	0606 160	8.90
0.05 - 1.0	300	13	0606 162	10.20
0.05 - 1.0	200	20	0606 170	10.70
0.05 - 1.0	300	20	0606 172	13.50
0.1 - 2.0	200	20	0606 176	17.90
0.1 - 2.0	300	20	0606 178	26.20

## 0608 Feeler gauge, accuracy grade T3



### Model

- Conical blades
- Width 10 mm

Measuring range mm	Number of blades	Order no.	List price EUR
0.1 - 0.4	6	0608 140	1.90
0.05 - 1.0	13	0608 143	4.60
0.05 - 1.0	20	0608 144	7.20
0.03 - 1.0	32	0608 149	16.60



## 0612 Feeler gauge tapes in single boxes - INOX



### Model

- Stainless steel
- Width 12.7 mm
- Length 5 m
- Tape from 0.08 mm upwards marked with dimension

### Delivery

- Plastic box

✕	☒	Nominal size mm	Order no.	List price EUR
		0.01	0612 501	41.20
		0.02	0612 502	34.40
		0.03	0612 503	12.00
		0.04	0612 504	12.00
		0.05	0612 505	8.90
		0.06	0612 506	9.30
		0.07	0612 507	9.30
		0.08	0612 508	9.30
		0.09	0612 509	9.30
		0.10	0612 510	8.00
		0.12	0612 512	8.00
		0.15	0612 515	8.00
		0.18	0612 518	10.30
		0.20	0612 520	8.00
		0.25	0612 525	8.00

## 0612 Set of feeler gauge tapes in wallholder - INOX



### Model

- Refillable with selected feeler gauges
- Wall holder made of steel, gloss coated
- With size labels

### Delivery

- With holder and mounting fittings

✕	☒	Dimensions mm	Measuring range mm	Number of boxes	Order no.	List price EUR
		330 x 100 x 110	0.01 - 0.25	15	0612 180	203.00

## 0611 Accessories for feeler gauge tapes



0611 195



0611 197



0611 198

✕	☒	Description	Dimensions mm	Order no.	List price EUR
		Holder for feeler gauge tape	125 x 17	0611 195	2.70
		Wallholder for 0.01 - 0.25 mm	330 x 100 x 110	0611 197	39.00
		Wallholder for 0.3 - 1.0 mm	330 x 210 x 220	0611 198	59.00



## 0611 Feeler gauge tapes in single boxes



### Model

- Hardened carbon steel
- Width 12.7 mm
- Length 5 m
- Tape from 0.08 mm upwards marked with dimension

### Delivery

- Plastic box

☒	☒	Nominal size mm	Order no.	List price EUR
		0.005	0611 300	79.00
		0.01	0611 501	31.30
		0.02	0611 502	25.90
		0.03	0611 503	9.00
		0.04	0611 504	9.00
		0.05	0611 505	6.80
		0.06	0611 506	7.10
		0.07	0611 507	7.10
		0.08	0611 508	7.10
		0.09	0611 509	7.10
		0.10	0611 510	6.00
		0.12	0611 512	6.00
		0.15	0611 515	6.00
		0.18	0611 518	7.90
		0.20	0611 520	6.00
		0.25	0611 525	6.00
		0.30	0611 530	7.00
		0.35	0611 535	7.00
		0.40	0611 540	8.00
		0.45	0611 545	8.00
		0.50	0611 550	8.00
		0.55	0611 552	10.30
		0.60	0611 554	10.30
		0.65	0611 556	10.30
		0.70	0611 558	10.30
		0.75	0611 560	10.30
		0.80	0611 562	10.30
		0.85	0611 564	10.50
		0.90	0611 566	11.00
		0.95	0611 568	11.00
		1.0	0611 570	11.00

## 0611 Set of feeler gauge tapes in wallholder



### Model

- Refillable with selected feeler gauges
- Wall holder made of steel, gloss coated
- With size labels

### Delivery

- With holder and mounting fittings

☒	☒	Dimensions mm	Measuring range mm	Number of boxes	Order no.	List price EUR
		330 x 100 x 110	0.01 - 0.25	15	0611 180	155.00
		330 x 210 x 220	0.3 - 1.0	15	0611 190	176.00



## 0613 Precision reference sheets



0613 607



0613 709



0613 812



0613 912

Nominal size mm	Brass, 150 x 500 mm, 5 pieces		Carbon steel, 50 x 300 mm, 10 pieces		Stainless steel, 100 x 500 mm, 5 pieces		Stainless steel, 150 x 500 mm, 5 pieces	
	Order no.	List price EUR	Order no.	List price EUR	Order no.	List price EUR	Order no.	List price EUR
0.01			0613 607	68.00				
0.02			0613 609	36.70	0613 709	51.00		
0.025	0613 912	56.00					0613 812	56.00
0.03			0613 614	25.80				
0.04			0613 616	25.80				
0.05	0613 918	45.00	0613 618	25.80	0613 718	30.60	0613 818	45.50
0.06			0613 620	17.60				
0.07			0613 622	17.60				
0.075	0613 924	45.00					0613 824	45.50
0.08			0613 626	17.60				
0.09			0613 628	17.60				
0.10	0613 930	42.70	0613 630	18.20	0613 730	28.70	0613 830	43.10
0.12			0613 632	18.20				
0.15	0613 934	42.70	0613 634	18.20	0613 734	28.70	0613 834	43.10
0.18			0613 636	18.20				
0.20	0613 938	53.00	0613 638	18.20	0613 738	36.20	0613 838	54.00
0.25	0613 940	53.00	0613 640	18.20			0613 840	54.00
0.30	0613 942	53.00	0613 642	18.20	0613 742	36.20	0613 842	54.00
0.35			0613 644	20.20				
0.40	0613 946	63.00	0613 646	20.20	0613 746	40.80	0613 846	63.00
0.45			0613 648	20.20				
0.50	0613 950	72.00	0613 650	20.20	0613 750	46.70	0613 850	73.00
0.60			0613 652	32.30	0613 752	56.00		
0.70			0613 654	32.30	0613 754	56.00		
0.80			0613 656	32.30	0613 756	68.00		
0.90			0613 658	32.30	0613 758	68.00		
1.00			0613 660	32.30	0613 760	75.00	0613 860	118.00



## 0613 Feeler gauge tapes

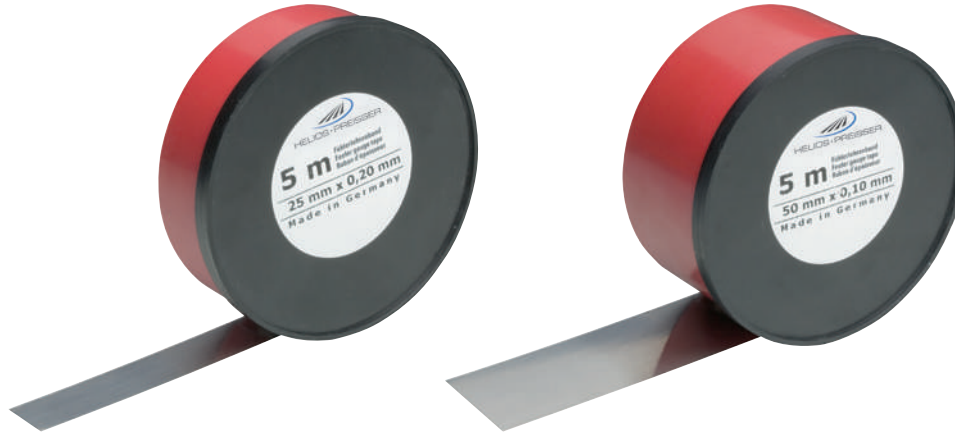

Nominal size mm	Brass, width 150 mm length 5 m		Carbon steel, width 25 mm length 5 m		Carbon steel, width 50 mm length 5 m		Stainless steel, width 100 mm length 5 m		Stainless steel, width 150 mm length 5 m	
	Order no.	List price EUR	Order no.	List price EUR	Order no.	List price EUR	Order no.	List price EUR	Order no.	List price EUR
0.01			0613 107	68.00	0613 207	98.00				
0.02			0613 109	36.70	0613 209	53.00	0613 309	94.00		
0.025	0613 512	106.00							0613 412	107.00
0.03			0613 114	25.80	0613 214	37.10				
0.04			0613 116	25.80	0613 216	37.10				
0.05	0613 518	85.00	0613 118	25.80	0613 218	37.10	0613 318	56.00	0613 418	86.00
0.06			0613 120	17.60	0613 220	25.30				
0.07			0613 122	17.60	0613 222	25.30				
0.075	0613 524	85.00							0613 424	86.00
0.08			0613 126	17.60	0613 226	25.30				
0.09			0613 128	17.60	0613 228	25.30				
0.10	0613 530	81.00	0613 130	18.20	0613 230	26.30	0613 330	53.00	0613 430	82.00
0.12					0613 232	26.30				
0.15	0613 534	81.00	0613 134	18.20	0613 234	26.30	0613 334	53.00	0613 434	82.00
0.18					0613 236	26.30				
0.20	0613 538	101.00	0613 138	18.20	0613 238	26.30	0613 338	68.00	0613 438	103.00
0.25	0613 540	101.00			0613 240	26.30			0613 440	103.00
0.30	0613 542	101.00	0613 142	18.20	0613 242	26.30	0613 342	68.00	0613 442	103.00
0.35					0613 244	28.70				
0.40	0613 546	113.00	0613 146	20.20	0613 246	28.70	0613 346	77.00	0613 446	114.00
0.45					0613 248	28.70				
0.50	0613 550	132.00	0613 150	20.20	0613 250	28.70	0613 350	88.00	0613 450	133.00
0.60			0613 152	32.30	0613 252	46.70	0613 352	105.00		
0.70			0613 154	32.30	0613 254	46.70	0613 354	105.00		
0.80			0613 156	32.30	0613 256	46.70	0613 356	126.00		
0.90			0613 158	32.30	0613 258	46.70	0613 358	126.00		
1.00			0613 160	32.30	0613 260	46.70	0613 360	144.00		



## 0609 8 piece gauge set



### Model

- Universal grinding gauge – thickness 2 mm, scales in mm graduation, angles 120°, 118°, 90°, 60° and 55°, special steel
- Welding gauge – measuring range 20 mm, reading 0.1mm, locking screw, special steel
- Radius gauge – 17 blades, concave and convex, locking nut, stainless steel, measuring range 1.0 – 7.0 mm
- Radius gauge – 16 blades, concave and convex, locking nut, stainless steel, measuring range 7.5 – 15.0 mm
- Radius gauge – 15 blades, concave and convex, locking nut, stainless steel, measuring range 15.5 – 25.0 mm
- Screw pitch gauge – 24 blades, for metric threads according to ISO, range 0.25 – 6.0 mm
- Screw pitch gauge – 28 blades, for Whitworth threads according to DIN, range 4.0 - 62.0 mm
- Feeler gauge - 20 conical blades, length 100 mm, range 0.05 - 1.00, stainless steel, locking nut

### Delivery

- Wooden box set

	Order no.	List price
	0609 190	EUR 82.00

## 0584 Comparative surface roughness standards



### Model

- 6 manufacturing processes
- 30 comparative standards

### Delivery

- Plastic case

	Order no.	List price
	0584 101	EUR 317.00



## 0623 Individual steel gauge blocks, tolerance class 0



### Model

- EN ISO 3650
- Special steel, hardened

Nominal size mm	Order no.	List price EUR
0.5	0623 100	42.20
1.0	0623 102	35.70
1.001	0623 104	35.70
1.002	0623 106	35.70
1.003	0623 108	35.70
1.004	0623 110	35.70
1.005	0623 112	35.70
1.006	0623 114	35.70
1.007	0623 116	35.70
1.008	0623 118	35.70
1.009	0623 120	35.70
1.01	0623 122	35.70
1.02	0623 130	35.70
1.03	0623 135	35.70
1.04	0623 140	35.70
1.05	0623 145	35.70
1.06	0623 150	35.70
1.07	0623 155	35.70
1.08	0623 160	35.70
1.09	0623 165	35.70
1.10	0623 170	35.70
1.11	0623 175	35.70
1.12	0623 180	35.70
1.13	0623 185	35.70
1.14	0623 190	35.70
1.15	0623 195	35.70
1.16	0623 200	35.70
1.17	0623 205	35.70
1.18	0623 210	35.70
1.19	0623 215	35.70
1.20	0623 220	35.70
1.21	0623 225	35.70
1.22	0623 230	35.70
1.23	0623 235	35.70
1.24	0623 240	35.70
1.25	0623 245	35.70
1.26	0623 250	35.70
1.27	0623 255	35.70
1.28	0623 260	35.70
1.29	0623 265	35.70

Nominal size mm	Order no.	List price EUR
1.30	0623 270	35.70
1.31	0623 275	35.70
1.32	0623 280	35.70
1.33	0623 285	35.70
1.34	0623 290	35.70
1.35	0623 295	35.70
1.36	0623 300	35.70
1.37	0623 305	35.70
1.38	0623 310	35.70
1.39	0623 315	35.70
1.40	0623 320	35.70
1.41	0623 325	35.70
1.42	0623 330	35.70
1.43	0623 335	35.70
1.44	0623 340	35.70
1.45	0623 345	35.70
1.46	0623 350	35.70
1.47	0623 355	35.70
1.48	0623 360	35.70
1.49	0623 365	35.70
1.50	0623 370	35.70
1.60	0623 375	35.70
1.70	0623 380	35.70
1.80	0623 385	35.70
1.90	0623 390	35.70
2.00	0623 395	35.70
2.50	0623 400	37.90
3.00	0623 405	37.90
3.50	0623 410	37.90
4.00	0623 415	37.90
4.50	0623 420	37.90
5.00	0623 425	37.90
5.50	0623 430	37.90
6.00	0623 435	37.90
6.50	0623 440	37.90
7.00	0623 445	37.90
7.50	0623 450	37.90
8.00	0623 455	37.90
8.50	0623 460	37.90
9.00	0623 465	37.90

Nominal size mm	Order no.	List price EUR
9.50	0623 470	37.90
10.00	0623 475	45.40
11.00	0623 500	45.40
12.00	0623 510	45.40
13.00	0623 520	45.40
14.00	0623 530	45.40
15.00	0623 540	45.40
16.00	0623 550	45.40
17.00	0623 560	45.40
18.00	0623 570	45.40
19.00	0623 580	45.40
20.00	0623 590	45.40
21.00	0623 600	45.40
22.00	0623 610	45.40
23.00	0623 620	45.40
24.00	0623 630	45.40
25.00	0623 640	45.40
30.00	0623 650	54.00
35.00	0623 660	54.00
40.00	0623 670	54.00
50.00	0623 680	54.00
60.00	0623 690	54.00
70.00	0623 700	54.00
80.00	0623 710	67.00
90.00	0623 720	67.00
100.00	0623 730	80.00
125.00	0623 740	283.00
150.00	0623 750	283.00
175.00	0623 760	283.00
200.00	0623 770	338.00
300.00	0623 780	482.00
400.00	0623 790	626.00
500.00	0623 800	866.00
600.00	0623 810	1353.00
700.00	0623 820	1403.00
800.00	0623 830	1732.00
900.00	0623 840	2053.00
1000.00	0623 850	2545.00





## 0624 Individual steel gauge blocks, tolerance class 1



### Model

- EN ISO 3650
- Special steel, hardened

Nominal size mm	Order no.	List price EUR
0.5	0624 100	28.10
1.0	0624 102	23.90
1.001	0624 104	23.90
1.002	0624 106	23.90
1.003	0624 108	23.90
1.004	0624 110	23.90
1.005	0624 112	23.90
1.006	0624 114	23.90
1.007	0624 116	23.90
1.008	0624 118	23.90
1.009	0624 120	23.90
1.01	0624 122	23.90
1.02	0624 130	23.90
1.03	0624 135	23.90
1.04	0624 140	23.90
1.05	0624 145	23.90
1.06	0624 150	23.90
1.07	0624 155	23.90
1.08	0624 160	23.90
1.09	0624 165	23.90
1.10	0624 170	23.90
1.11	0624 175	23.90
1.12	0624 180	23.90
1.13	0624 185	23.90
1.14	0624 190	23.90
1.15	0624 195	23.90
1.16	0624 200	23.90
1.17	0624 205	23.90
1.18	0624 210	23.90
1.19	0624 215	23.90
1.20	0624 220	23.90
1.21	0624 225	23.90
1.22	0624 230	23.90
1.23	0624 235	23.90
1.24	0624 240	23.90
1.25	0624 245	23.90
1.26	0624 250	23.90
1.27	0624 255	23.90
1.28	0624 260	23.90
1.29	0624 265	23.90

Nominal size mm	Order no.	List price EUR
1.30	0624 270	23.90
1.31	0624 275	23.90
1.32	0624 280	23.90
1.33	0624 285	23.90
1.34	0624 290	23.90
1.35	0624 295	23.90
1.36	0624 300	23.90
1.37	0624 305	23.90
1.38	0624 310	23.90
1.39	0624 315	23.90
1.40	0624 320	23.90
1.41	0624 325	23.90
1.42	0624 330	23.90
1.43	0624 335	23.90
1.44	0624 340	23.90
1.45	0624 345	23.90
1.46	0624 350	23.90
1.47	0624 355	23.90
1.48	0624 360	23.90
1.49	0624 365	23.90
1.50	0624 370	23.90
1.60	0624 375	23.90
1.70	0624 380	23.90
1.80	0624 385	23.90
1.90	0624 390	23.90
2.00	0624 395	23.90
2.50	0624 400	24.90
3.00	0624 405	24.90
3.50	0624 410	24.90
4.00	0624 415	24.90
4.50	0624 420	24.90
5.00	0624 425	24.90
5.50	0624 430	24.90
6.00	0624 435	24.90
6.50	0624 440	24.90
7.00	0624 445	24.90
7.50	0624 450	24.90
8.00	0624 455	24.90
8.50	0624 460	24.90
9.00	0624 465	24.90

Nominal size mm	Order no.	List price EUR
9.50	0624 470	24.90
10.00	0624 475	30.30
11.00	0624 500	30.30
12.00	0624 510	30.30
13.00	0624 520	30.30
14.00	0624 530	30.30
15.00	0624 540	30.30
16.00	0624 550	30.30
17.00	0624 560	30.30
18.00	0624 570	30.30
19.00	0624 580	30.30
20.00	0624 590	30.30
21.00	0624 600	30.30
22.00	0624 610	30.30
23.00	0624 620	30.30
24.00	0624 630	30.30
25.00	0624 640	30.30
30.00	0624 650	35.70
35.00	0624 660	35.70
40.00	0624 670	35.70
50.00	0624 680	35.70
60.00	0624 690	35.70
70.00	0624 700	35.70
80.00	0624 710	44.40
90.00	0624 720	44.40
100.00	0624 730	53.00
125.00	0624 740	172.00
150.00	0624 750	172.00
175.00	0624 760	172.00
200.00	0624 770	204.00
300.00	0624 780	293.00
400.00	0624 790	379.00
500.00	0624 800	525.00
600.00	0624 810	730.00
700.00	0624 820	758.00
800.00	0624 830	937.00
900.00	0624 840	1110.00
1000.00	0624 850	1375.00



## 0625 Individual steel gauge blocks, tolerance class 2



### Model

- EN ISO 3650
- Special steel, hardened

Nominal size mm	Order no.	List price EUR
0.5	0625 100	22.70
1.0	0625 102	19.50
1.001	0625 104	19.50
1.002	0625 106	19.50
1.003	0625 108	19.50
1.004	0625 110	19.50
1.005	0625 112	19.50
1.006	0625 114	19.50
1.007	0625 116	19.50
1.008	0625 118	19.50
1.009	0625 120	19.50
1.01	0625 122	19.50
1.02	0625 130	19.50
1.03	0625 135	19.50
1.04	0625 140	19.50
1.05	0625 145	19.50
1.06	0625 150	19.50
1.07	0625 155	19.50
1.08	0625 160	19.50
1.09	0625 165	19.50
1.10	0625 170	19.50
1.11	0625 175	19.50
1.12	0625 180	19.50
1.13	0625 185	19.50
1.14	0625 190	19.50
1.15	0625 195	19.50
1.16	0625 200	19.50
1.17	0625 205	19.50
1.18	0625 210	19.50
1.19	0625 215	19.50
1.20	0625 220	19.50
1.21	0625 225	19.50
1.22	0625 230	19.50
1.23	0625 235	19.50
1.24	0625 240	19.50
1.25	0625 245	19.50
1.26	0625 250	19.50
1.27	0625 255	19.50
1.28	0625 260	19.50
1.29	0625 265	19.50

Nominal size mm	Order no.	List price EUR
1.30	0625 270	19.50
1.31	0625 275	19.50
1.32	0625 280	19.50
1.33	0625 285	19.50
1.34	0625 290	19.50
1.35	0625 295	19.50
1.36	0625 300	19.50
1.37	0625 305	19.50
1.38	0625 310	19.50
1.39	0625 315	19.50
1.40	0625 320	19.50
1.41	0625 325	19.50
1.42	0625 330	19.50
1.43	0625 335	19.50
1.44	0625 340	19.50
1.45	0625 345	19.50
1.46	0625 350	19.50
1.47	0625 355	19.50
1.48	0625 360	19.50
1.49	0625 365	19.50
1.50	0625 370	19.50
1.60	0625 375	19.50
1.70	0625 380	19.50
1.80	0625 385	19.50
1.90	0625 390	19.50
2.00	0625 395	19.50
2.50	0625 400	19.50
3.00	0625 405	19.50
3.50	0625 410	19.50
4.00	0625 415	19.50
4.50	0625 420	19.50
5.00	0625 425	19.50
5.50	0625 430	19.50
6.00	0625 435	19.50
6.50	0625 440	19.50
7.00	0625 445	19.50
7.50	0625 450	19.50
8.00	0625 455	19.50
8.50	0625 460	19.50
9.00	0625 465	19.50

Nominal size mm	Order no.	List price EUR
9.50	0625 470	19.50
10.00	0625 475	23.90
11.00	0625 500	23.90
12.00	0625 510	23.90
13.00	0625 520	23.90
14.00	0625 530	23.90
15.00	0625 540	23.90
16.00	0625 550	23.90
17.00	0625 560	23.90
18.00	0625 570	23.90
19.00	0625 580	23.90
20.00	0625 590	23.90
21.00	0625 600	23.90
22.00	0625 610	23.90
23.00	0625 620	23.90
24.00	0625 630	23.90
25.00	0625 640	23.90
30.00	0625 650	28.10
35.00	0625 660	28.10
40.00	0625 670	28.10
50.00	0625 680	28.10
60.00	0625 690	28.10
70.00	0625 700	28.10
80.00	0625 710	35.70
90.00	0625 720	35.70
100.00	0625 730	42.20
125.00	0625 740	138.00
150.00	0625 750	138.00
175.00	0625 760	138.00
200.00	0625 770	147.00
300.00	0625 780	232.00
400.00	0625 790	273.00
500.00	0625 800	357.00
600.00	0625 810	444.00
700.00	0625 820	530.00
800.00	0625 830	656.00
900.00	0625 840	777.00
1000.00	0625 850	963.00



## 0633 Gauge block accessories sets



### Delivery

- Wooden case



No. of parts	Gauge block holder (mm)					Radiused measuring jaw pairs (mm)						Scriber	Centre point	Plane parallel jaws (pair)	Knife edge jaws (pair)	Holder base	Order no.	List Price EUR
	0-50	0-100	100-200	0-300	200-400	300-500	4	10	16	20	30							
4				•		•						•					0633 130	1151.00
10	•	•	•			•	•					•	•			•	0633 131	1337.00
14	•	•	•			•	•	•	•			•	•			•	0633 132	1730.00
23	•	•	•	•	•	•	•	•	•	•	•	•	•	•		•	0633 133	3417.00

## 0633 Radiused measuring jaws with cylindrical shoulders / pair



✕	🏠	Nominal size	Measuring depth	Order no.	List price EUR
		mm	mm		
		4	8	0633 150	214.00
		10	15	0633 151	214.00
		16	20	0633 152	229.00
		20	40	0633 153	281.00
		30	65	0633 154	396.00
		40	95	0633 155	516.00

## 0633 Inspection points, pair



### Model

- Special steel, hardened

✕	🏠	Dimensions	Order no.	List price EUR
		mm		
		55 x 9 x 9	0633 170	255.00



0633 Scribers



Model

- Special steel, hardened or carbide

✕	☒	Dimensions mm	Order no.	List price EUR
<b>Carbide</b>				
		55 x 9 x 8	0633 172	375.00
<b>Special steel</b>				
		55 x 9 x 8	0633 171	93.00

0633 Centre point



Model

- Special steel, hardened

✕	☒	Dimensions mm	Order no.	List price EUR
		55 x 9 x 12	0633 173	120.00

0633 Plane / parallel jaws, pair



Model

- For external measurement

✕	☒	Dimensions mm	Order no.	List price EUR
<b>For external measurements</b>				
		100 x 9 x 20	0633 174	208.00
		125 x 9 x 20	0633 175	245.00
<b>For internal and external measurements</b>				
		100 x 9 x 20	0633 176	386.00
		125 x 9 x 20	0633 177	458.00



## 0633 Gauge block holders with rapid adjustment



		Measuring range mm	Order no.	List price EUR
		0 - 50	0633 136	182.00
		0 - 100	0633 137	208.00
		0 - 200	0633 138	250.00
		100 - 200	0633 139	229.00
		100 - 300	0633 140	271.00
		200 - 400	0633 141	313.00
		300 - 500	0633 142	354.00
		400 - 600	0633 143	386.00
		500 - 800	0633 144	448.00
		800 - 1000	0633 145	625.00

## 0633 Stand for gauge block holder

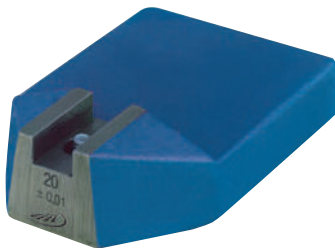

### Model

- Special steel, hardened

		Dimensions mm	Order no.	List price EUR
		103 x 70 x 27	0633 182	162.00

## 0633 Gauge block maintenance set



### Model

- Set consists of:
- Linen cloth
  - Chamois leather
  - 1 jar of anti corrosion oil
  - Oil stone
  - Fine paint brush
  - Broad paint brush
  - User manual

### Delivery

- Wooden case

		Order no.	List price EUR
		0633 001	314.00



## 0633 Steel gauge block inspection sets for micrometers



### Model

- EN ISO 3650
- Special steel, hardened
- Tolerance class 1

### Delivery

- Wooden case

☒ ☒	Max. nominal size mm	Order no.	List price EUR
<b>10 pieces, excludes the optical flat</b>			
	2.5 / 5.1 / 7.7 / 10.3 / 12.9 / 15.0 / 17.6 / 20.2 / 22.8 / 25.0	0633 810	275.00
<b>5 pieces with optical flat</b>			
	5.1 / 10.3 / 15.0 / 20.2 / 25.0	0633 805	339.00
<b>8 pieces with optical flat</b>			
	5.1 / 10.3 / 15.0 / 20.2 / 25.0 / 50.0 / 75.0 / 100	0633 808	453.00

## 0633 Steel gauge block inspection set for calipers

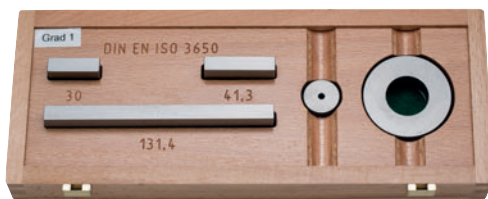

### Model

- EN ISO 3650
- Special steel, hardened
- Tolerance class 1
- Supplied with setting rings 4 mm and 25 mm

### Delivery

- Wooden case

☒ ☒	For measuring range mm	Max. nominal size mm	Order no.	List price EUR
<b>3 pieces</b>				
	200	30.0 / 41.3 / 131.4	0633 833	563.00
<b>4 pieces</b>				
	300	30.0 / 41.3 / 131.4 / 243.5	0633 834	751.00
<b>6 pieces</b>				
	500	30.0 / 41.3 / 131.4 / 243.5 / 281.2 / 481.1	0633 836	1341.00
<b>5 pieces</b>				
	1000	131.4 / 243.5 / 281.2 / 481.1 / 900	0633 838	2371.00



## 0633 Parallel steel gauge block sets



### Model

- EN ISO 3650
- Special steel, hardened

### Delivery

- Wooden case

		Number of gauge blocks	Max. nominal size mm	Increment mm	Order no.	List price EUR
<b>Tolerance class 0</b>						
		103	1.005 1.01 - 1.49 0.5 - 24.5 25.0 - 100.0	- 0.01 0.5 25	0633 014	889.00
		87	1.001 - 1.009 1.01 - 1.49 0.5 - 9.5 10.0 - 100.0	0.001 0.01 0.5 10	0633 016	812.00
		47	1.005 1.01 - 1.09 1.11 - 1.19 1.1 - 1.9 1.0 - 9.0 10.0 - 100.0	- 0.01 0.01 0.1 1 10	0633 018	528.00
		32	1.005 1.01 - 1.09 1.1 - 1.9 1.0 - 9.0 10.0 - 30.0 50.0	- 0.01 0.1 1 10 -	0633 020	386.00
<b>Tolerance class 1</b>						
		103	1.005 1.01 - 1.49 0.5 - 24.5 25.0 - 100.0	- 0.01 0.5 25	0633 114	684.00
		87	1.001 - 1.009 1.01 - 1.49 0.5 - 9.5 10.0 - 100.0	0.001 0.01 0.5 10	0633 116	521.00
		47	1.005 1.01 - 1.09 1.11 - 1.19 1.1 - 1.9 1.0 - 9.0 10.0 - 100.0	- 0.01 0.01 0.1 1 10	0633 118	322.00
		32	1.005 1.01 - 1.09 1.1 - 1.9 1.0 - 9.0 10.0 - 30.0 50.0	- 0.01 0.1 1 10 -	0633 120	234.00



## 0633 Parallel steel gauge block sets

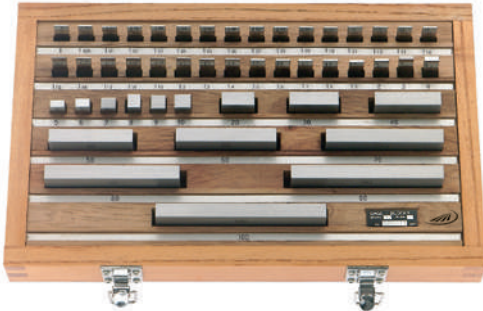

### Model

- EN ISO 3650
- Special steel, hardened

### Delivery

- Wooden case

	Number of gauge blocks	Max. nominal size mm	Increment mm	Order no.	List price EUR
<b>Tolerance class 2</b>					
	103	1.005 1.01 - 1.49 0.5 - 24.5 25.0 - 100.0	- 0.01 0.5 25	0633 214	432.00
	87	1.001 - 1.009 1.01 - 1.49 0.5 - 9.5 10.0 - 100.0	0.001 0.01 0.5 10	0633 216	341.00
	47	1.005 1.01 - 1.09 1.11 - 1.19 1.1 - 1.9 1.0 - 9.0 10.0 - 100.0	- 0.01 0.01 0.1 1 10	0633 218	233.00
	32	1.005 1.01 - 1.09 1.1 - 1.9 1.0 - 9.0 10.0 - 30.0 50.0	- 0.01 0.1 1 10 -	0633 220	154.00





## 0634 Carbide gauge block sets



### Model

- EN ISO 3650
- Carbide

### Delivery

- Wooden case

		Number of gauge blocks	Max. nominal size mm	Increment mm	Order no.	List price EUR
<b>Tolerance class 0</b>						
		103	1.005 1.01 - 1.49 0.5 - 24.5 25.0 - 100.0	- 0.01 0.5 25	0634 014	4573.00
		87	1.001 - 1.009 1.01 - 1.49 0.5 - 9.5 10.0 - 100.0	0.001 0.01 0.5 10	0634 016	3768.00
		47	1.005 1.01 - 1.09 1.11 - 1.19 1.1 - 1.9 1.0 - 9.0 10.0 - 100.0	- 0.01 0.01 0.1 1 10	0634 017	2462.00
		32	1.005 1.01 - 1.09 1.1 - 1.9 1.0 - 9.0 10.0 - 30.0 50.0	- 0.01 0.1 1 10 -	0634 020	1293.00
<b>Tolerance class 1</b>						
		103	1.005 1.01 - 1.49 0.5 - 24.5 25.0 - 100.0	- 0.01 0.5 25	0634 114	4025.00
		87	1.001 - 1.009 1.01 - 1.49 0.5 - 9.5 10.0 - 100.0	0.001 0.01 0.5 10	0634 116	3291.00
		47	1.005 1.01 - 1.09 1.11 - 1.19 1.1 - 1.9 1.0 - 9.0 10.0 - 100.0	- 0.01 0.01 0.1 1 10	0634 117	2206.00
		32	1.005 1.01 - 1.09 1.1 - 1.9 1.0 - 9.0 10.0 - 30.0 50.0	- 0.01 0.1 1 10 -	0634 120	1122.00



## 0634 Ceramic gauge block sets



### Model

- EN ISO 3650
- Ceramic

### Delivery

- Wooden case

		Number of gauge blocks	Max. nominal size mm	Increment mm	Order no.	List price EUR
<b>Tolerance class 0</b>						
		103	1.005 1.01 - 1.49 0.5 - 24.5 25.0 - 100.0	- 0.01 0.5 25	0634 514	6385.00
		87	1.001 - 1.009 1.01 - 1.49 0.5 - 9.5 10.0 - 100.0	0.001 0.01 0.5 10	0634 516	5085.00
		47	1.005 1.01 - 1.09 1.11 - 1.19 1.1 - 1.9 1.0 - 9.0 10.0 - 100.0	- 0.01 0.01 0.1 1 10	0634 517	3032.00
		32	1.005 1.01 - 1.09 1.1 - 1.9 1.0 - 9.0 10.0 - 30.0 50.0	- 0.01 0.1 1 10 -	0634 520	1841.00
<b>Tolerance class 1</b>						
		103	1.005 1.01 - 1.49 0.5 - 24.5 25.0 - 100.0	- 0.01 0.5 25	0634 614	5345.00
		87	1.001 - 1.009 1.01 - 1.49 0.5 - 9.5 10.0 - 100.0	0.001 0.01 0.5 10	0634 616	4248.00
		47	1.005 1.01 - 1.09 1.11 - 1.19 1.1 - 1.9 1.0 - 9.0 10.0 - 100.0	- 0.01 0.01 0.1 1 10	0634 617	2534.00
		32	1.005 1.01 - 1.09 1.1 - 1.9 1.0 - 9.0 10.0 - 30.0 50.0	- 0.01 0.1 1 10 -	0634 620	1536.00



## 0636 Set of pin gauges

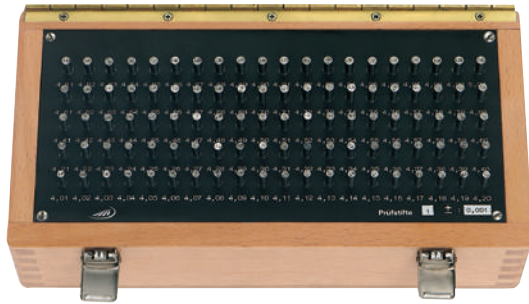

### Model

- DIN 2269
- Made out of high quality gauge steel

### Delivery

- Wooden case

DIN  
2269

		Length mm	Number of pins	Max. nominal size mm	Increment mm	Order no.	List price EUR
<b>Special steel, hardened and aged - Tolerance class 1</b>							
		40	51	0.5 - 1.0	0.01	0636 301	812.00
		70	21	1.0 - 2.0	0.05	0636 321	246.00
		70	21	2.0 - 3.0	0.05	0636 322	246.00
		70	21	3.0 - 4.0	0.05	0636 323	304.00
		70	21	4.0 - 5.0	0.05	0636 324	304.00
		70	21	5.0 - 6.0	0.05	0636 325	304.00
		70	21	6.0 - 7.0	0.05	0636 326	371.00
		70	21	7.0 - 8.0	0.05	0636 327	371.00
		70	21	8.0 - 9.0	0.05	0636 328	371.00
		70	21	9.0 - 10.0	0.05	0636 329	371.00
		70	101	1.0 - 2.0	0.01	0636 341	1034.00
		70	100	2.01 - 3.0	0.01	0636 342	1034.00
		70	100	3.01 - 4.0	0.01	0636 343	1310.00
		70	100	4.01 - 5.0	0.01	0636 344	1310.00
		70	100	5.01 - 6.0	0.01	0636 345	1310.00
		70	100	6.01 - 7.0	0.01	0636 346	1612.00
		70	100	7.01 - 8.0	0.01	0636 347	1612.00
		70	100	8.01 - 9.0	0.01	0636 348	1612.00
		70	100	9.01 - 10.0	0.01	0636 349	1612.00
		70	91	1.0 - 10.0	0.1	0636 351	1321.00
		70	81	1.0 - 5.0	0.05	0636 352	1200.00
<b>Special steel, hardened and aged - Tolerance class 2</b>							
		70	101	1.0 - 2.0	0.01	0636 372	723.00
		70	100	2.01 - 3.0	0.01	0636 373	723.00
		70	100	3.01 - 4.0	0.01	0636 374	952.00
		70	100	4.01 - 5.0	0.01	0636 375	952.00
		70	100	5.01 - 6.0	0.01	0636 376	952.00
		70	100	6.01 - 7.0	0.01	0636 377	1153.00
		70	100	7.01 - 8.0	0.01	0636 378	1308.00
		70	100	8.01 - 9.0	0.01	0636 379	1308.00
		70	100	9.01 - 10.0	0.01	0636 380	1308.00



## 0636 Pin gauge holder



### Model

- Die cast
- With locking screw

Measuring range mm	Length mm	Order no.	List price EUR
1 - 2	60	0636 392	13.20
2 - 4	68	0636 393	15.10
4 - 6	76	0636 394	28.70
6 - 8	84	0636 395	36.80
8 - 10	92	0636 396	42.40

## 0643 Snap gauge, double jaw



### Model

- Dimensions 3 to 100 mm
- Gauge steel
- Hardened measuring faces
- Dimensions acc. DIN 2230
- Manufacturing tolerances: according to DIN 7163

### Delivery

- Available on request
- Important: Please mention dimension and fit

## 0649 Adjustable snap gauges



### Model

- Special cast iron
- 1 fixed measuring face, 2 adjustable square measuring faces

### Delivery

- Cardboard box

Max. nominal size mm	Order no.	List price EUR
0 - 6	0649 201	72.00
6 - 13	0649 202	72.00
13 - 19	0649 203	72.00
19 - 26	0649 204	74.00
26 - 32	0649 205	74.00
32 - 38	0649 206	78.00
38 - 44	0649 207	78.00
44 - 51	0649 208	81.00
51 - 57	0649 209	81.00
57 - 64	0649 210	85.00

Max. nominal size mm	Order no.	List price EUR
64 - 70	0649 211	85.00
70 - 78	0649 212	93.00
78 - 87	0649 213	93.00
87 - 97	0649 215	103.00
97 - 106	0649 216	118.00
106 - 116	0649 217	118.00
116 - 125	0649 219	141.00
125 - 135	0649 220	183.00
135 - 144	0649 222	210.00
144 - 156	0649 223	210.00



## 0650 Adjustable snap gauges



0650 103



0650 114

### Model

- Adjustable
- Light alloy cast frame
- Carbide tipped measuring faces
- Without indicator
- Up to 100 mm with centering support and lift-off device. Snap gauges above 100 mm excludes centering support and lift-off device

### Delivery

- Without digital indicator
- Cardboard box

✕	📏	Measuring range mm	Measuring surface mm	Order no.	List price EUR
		100 - 150	40 x 18	0650 105	1731.00
		150 - 200	40 x 18	0650 106	1959.00
		200 - 250	40 x 18	0650 107	2247.00
		250 - 300	40 x 18	0650 108	2339.00
		300 - 350	40 x 18	0650 109	2482.00
		350 - 400	40 x 18	0650 110	2686.00
		400 - 450	40 x 18	0650 111	2883.00
		450 - 500	40 x 18	0650 112	3081.00
		500 - 550	40 x 18	0650 113	3280.00
		550 - 600	40 x 18	0650 114	3545.00



## 0656 Ring gauges



### Model

- DIN 2250-1 (C)
- Hardened gauge steel
- For setting internal measuring instruments

**DIN**  
**2250-1**

⌕	📏	Nominal size	Order no.	List price	⌕	📏	Nominal size	Order no.	List price
		mm		EUR			mm		EUR
		3.0	0656 309	57.00			58	0656 355	108.00
		3.5	0656 310	50.00			60	0656 356	113.00
		4.0	0656 311	50.00			62	0656 357	116.00
		4.5	0656 312	50.00			65	0656 358	123.00
		5.0	0656 313	49.20			68	0656 359	132.00
		6.0	0656 314	47.90			70	0656 360	137.00
		7.0	0656 315	47.90			72	0656 361	142.00
		8.0	0656 316	47.90			75	0656 362	146.00
		9.0	0656 317	47.90			78	0656 363	154.00
		10.0	0656 318	47.90			80	0656 364	159.00
		11.0	0656 319	49.20			82	0656 365	168.00
		12.0	0656 320	50.00			85	0656 366	179.00
		12.5	0656 303	50.00			88	0656 367	191.00
		13.0	0656 321	51.00			90	0656 368	197.00
		14.0	0656 322	51.00			92	0656 369	205.00
		15.0	0656 323	52.00			95	0656 370	219.00
		16.0	0656 324	52.00			98	0656 371	229.00
		17.0	0656 325	53.00			100	0656 372	237.00
		17.5	0656 304	75.00			105	0656 373	248.00
		18.0	0656 326	53.00			110	0656 374	261.00
		19.0	0656 327	54.00			115	0656 375	272.00
		20	0656 328	56.00			120	0656 376	284.00
		21	0656 329	56.00			125	0656 377	297.00
		22	0656 330	56.00			130	0656 378	307.00
		23	0656 331	59.00			135	0656 379	320.00
		24	0656 332	60.00			140	0656 380	331.00
		25	0656 333	61.00			145	0656 381	343.00
		26	0656 334	63.00			150	0656 382	355.00
		27	0656 335	63.00			155	0656 383	388.00
		28	0656 336	64.00			160	0656 384	419.00
		30	0656 337	59.00			165	0656 385	450.00
		32	0656 338	67.00			170	0656 386	483.00
		33	0656 339	67.00			175	0656 387	516.00
		34	0656 340	68.00			180	0656 388	547.00
		35	0656 341	68.00			185	0656 389	580.00
		36	0656 342	69.00			190	0656 390	611.00
		37	0656 343	71.00			195	0656 391	644.00
		38	0656 344	72.00			200	0656 392	675.00
		40	0656 345	73.00			210	0656 393	712.00
		42	0656 346	77.00			220	0656 394	743.00
		44	0656 347	81.00			225	0656 305	893.00
		45	0656 348	83.00			230	0656 395	778.00
		46	0656 349	85.00			240	0656 396	813.00
		47	0656 350	88.00			250	0656 397	848.00
		48	0656 351	90.00			260	0656 398	883.00
		50	0656 352	93.00			270	0656 399	916.00
		52	0656 353	95.00			275	0656 306	983.00
		55	0656 354	104.00					



## 0637 Plug gauges



### Model

- Manufacturing tolerances: according to DIN 7150-2 and DIN 7164
- Fit H7
- All cylindrical
- Special dimensions with other tolerances are available upon request

✂	📏	Dimensions acc. to Din	Nominal size mm	Order no.	List price EUR
<b>Gauge steel, hardened</b>					
		2245-1	2	0637 103	31.10
		2245-1	2.2	0637 104	31.10
		2245-1	2.5	0637 105	31.10
		2245-1	2.8	0637 106	22.60
		2245-1	3	0637 107	22.60
		2245-1	3.5	0637 108	20.20
		2245-1	4	0637 109	20.20
		2245-1	4.5	0637 110	20.20
		2245-1	5	0637 111	19.10
		2245-1	6	0637 112	19.10
		2245-1	7	0637 113	20.20
		2245-1	8	0637 114	20.20
		2245-1	9	0637 115	21.60
		2245-1	10	0637 116	22.60
		2245-1	11	0637 117	22.60
		2245-1	12	0637 118	24.00
		2245-1	13	0637 119	25.10
		2245-1	14	0637 120	25.10
		2245-1	15	0637 121	25.80
		2245-1	16	0637 122	25.80
		2245-1	17	0637 123	27.00
		2245-1	18	0637 124	28.00
		2245-1	19	0637 125	28.00
		2245-1	20	0637 126	28.00
		2245-1	21	0637 127	29.50
		2245-1	22	0637 128	30.10
		2245-1	23	0637 129	31.10
		2245-1	24	0637 130	31.10
		2245-1	25	0637 131	32.30
		2245-1	26	0637 132	33.60
		2245-1	27	0637 133	33.60
		2245-1	28	0637 134	34.60
		2245-1	30	0637 135	34.60
		2245-1	32	0637 136	38.30

✂	📏	Dimensions acc. to Din	Nominal size mm	Order no.	List price EUR
		2245-1	33	0637 137	39.00
		2245-1	34	0637 138	40.10
		2245-1	35	0637 139	40.10
		2245-1	36	0637 140	41.10
		2245-1	37	0637 141	41.90
		2245-1	38	0637 142	43.10
		2245-1	40	0637 144	44.40
		2245-2	42	0637 146	45.70
		2245-2	43	0637 147	56.00
		2245-2	44	0637 148	49.20
		2245-2	45	0637 149	50.00
		2245-2	46	0637 150	51.00
		2245-2	47	0637 151	53.00
		2245-2	48	0637 152	54.00
		2245-2	50	0637 154	56.00
		2245-2	52	0637 155	59.00
		2245-2	55	0637 156	63.00
		2245-2	58	0637 157	67.00
		2245-2	60	0637 158	69.00
		2245-2	62	0637 159	73.00
		2245-2	65	0637 160	73.00
		2245-2	68	0637 161	80.00
		2245-2	70	0637 162	81.00
		2245-2	72	0637 163	83.00
		2245-2	75	0637 164	88.00
		2245-2	78	0637 165	92.00
		2245-2	80	0637 166	93.00
		2245-2	82	0637 167	95.00
		2245-2	85	0637 168	99.00
		2245-2	88	0637 169	104.00
		2245-2	90	0637 170	105.00
		2245-2	92	0637 171	108.00
		2245-2	95	0637 172	110.00
		2245-2	98	0637 173	114.00
		2245-2	100	0637 174	116.00



0637 Plug gauge set



Model

- DIN 2245
- Hardened gauge steel
- GO and NOGO

Delivery

- Wooden box

DIN 2245

✕	☒	Number of gauges	ISO fit	Nominal size mm	Order no.	List price EUR
		(3, 4, 5, 6, 8, 10, 12)				
		7	H7	3 - 12	0637 190	148.00

PLUG GAUGES WITH SPECIAL DIMENSIONS

FAST DELIVERY

More information and the price list on request or directly online at [www.helios-preisser.de/en/downloads](http://www.helios-preisser.de/en/downloads)

Downloads



Custom-made according to ISO Fits

or according to your Nominal size & tolerance

DIN 2245-Z / Gauge steel / All cylindrical

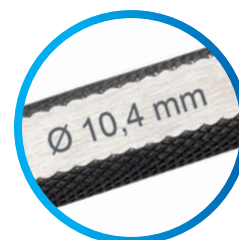





## 0658 Thread plug gauges



**DIN  
2280**

### Model

- DIN 2280
- For standard metric ISO threads DIN 13
- Gauge steel, hardened

Marked	Marked	ISO Fit	Type of thread	Nominal size	Thread pitch	Order no.	List price
				mm	mm		EUR
		6H	M	3.0	0.50	0658 009	68.00
		6H	M	4.0	0.70	0658 011	64.00
		6H	M	5.0	0.80	0658 012	63.00
		6H	M	6.0	1.00	0658 013	60.00
		6H	M	8.0	1.25	0658 015	63.00
		6H	M	10.0	1.50	0658 017	67.00
		6H	M	12.0	1.75	0658 019	72.00

## 0658 Set of thread plug gauges



### Delivery

- Wooden box

**DIN  
2280**

Marked	Marked	Tolerance class	Type of thread	Max. nominal size	Order no.	List price
				mm		EUR
		(M3, M4, M5, M6, M8, M10, M12)				
		6H	M	M3 - M12	0658 090	252.00

## 0658 GO thread ring gauges



### Model

- DIN 2285-1
- GO thread ring gauge
- For standard metric ISO threads DIN 13
- Hardened gauge steel

**DIN  
2285-1**

Marked	Marked	ISO Fit	Type of thread	Nominal size	Thread pitch	Order no.	List price
				mm	mm		EUR
		6g	M	3.0	0.50	0658 509	53.00
		6g	M	4.0	0.70	0658 511	49.20
		6g	M	5.0	0.80	0658 512	49.20
		6g	M	6.0	1.00	0658 513	49.20
		6g	M	8.0	1.25	0658 515	50.00
		6g	M	10.0	1.50	0658 517	59.00
		6g	M	12.0	1.75	0658 519	69.00



## 0658 NO GO thread ring gauges



### Model

- DIN 2299-1
- NOGO thread ring gauge
- For standard metric ISO threads DIN 13
- Hardened gauge steel

**DIN**  
2299-1

☒	☒	ISO Fit	Type of thread	Nominal size mm	Thread pitch mm	Order no.	List price EUR
		6g	M	3.0	0.50	0658 609	53.00
		6g	M	4.0	0.70	0658 611	49.20
		6g	M	5.0	0.8	0658 612	49.20
		6g	M	6.0	1.0	0658 613	49.20
		6g	M	8.0	1.25	0658 615	50.00
		6g	M	10.0	1.5	0658 617	59.00
		6g	M	12.0	1.75	0658 619	69.00

## 0658 Thread ring gauges GO

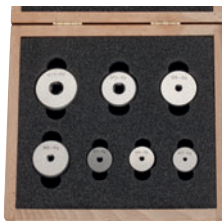

### Model

- 7-pieces
- Hardened gauge steel
- For standard metric ISO threads DIN 13
- Fit 6g

### Delivery

- Wooden case

**DIN**  
2285-1

☒	☒	ISO Fit	Type of thread	Nominal size mm	Order no.	List price EUR
		(M3, M4, M5, M6, M8, M10, M12)				
		6g	M	3 - 12	0658 590	252.00

## 0658 Thread ring gauges NO GO

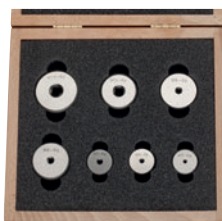

### Model

- 7-pieces
- Hardened gauge steel
- For standard metric ISO threads DIN 13
- Fit 6g

### Delivery

- Wooden case

**DIN**  
2299-1

☒	☒	ISO Fit	Type of thread	Nominal size mm	Order no.	List price EUR
		(M3, M4, M5, M6, M8, M10, M12)				
		6g	M	3 - 12	0658 690	252.00

# SAMPLES DATA TRANSMISSION

 **integrated  
IW wireless**

**NO CABLE**  
**NO RADIO MODULE**

Thanks to the integrated wireless system our measuring devices from series **i** offer simple data transmission without additional cables

Transmission of data directly to MS Excel® or into any application on Windows via keyboard interface

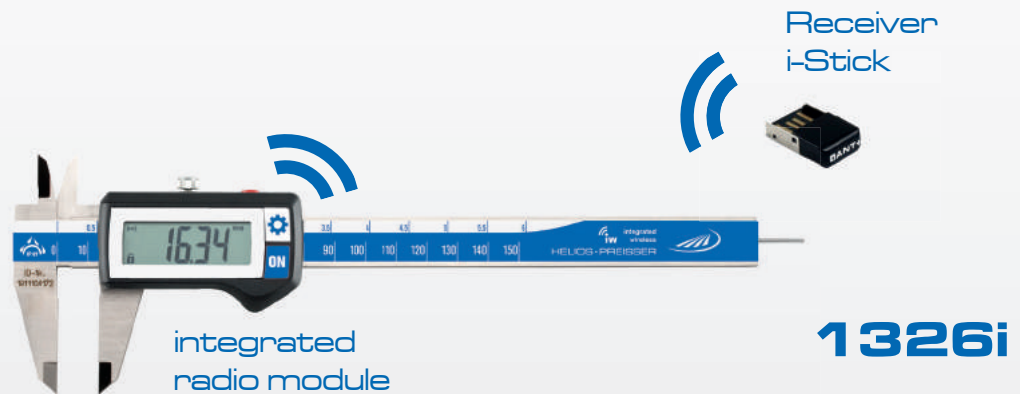

**DATA Variable**

**ONE INTERFACE**  
**MANY OPTIONS**



OUT **STANDARD** FOR  
DATA TRANSMISSION  
**WITH CABLES**

USB + RS 232 + DIGIMATIC

## **7. CHAPTER DATA TRANSMISSION**

**276 Data cables Data Variable / Software**

**277 Integrated Wireless**

**278 Data cables Opto / BlueDat**

**279 USB-keyboard interface**



## 1998 / 1997 Data cable DATA VARIABLE



### Our Interface: Data Variable

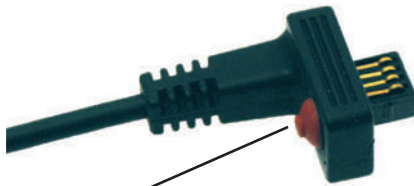

**DATA-Button**  
To transfer the measured results

### Possible connections



USB      RS 232      Digimatic

### Model

- Available for all DIGI-MET measuring instruments with a variable data output (DATA VARIABLE)
- Length 2 m
- With a data transfer button on the plug-in jack
- For use with MarCom Professional software to transfer the measured results to PC, laptop or workstation



1998 720



1997 501

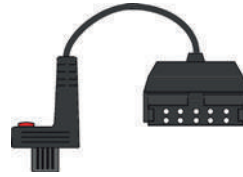

1998 501

⏪	⏩	Description	Order no.	List price EUR
		Cable DataVariable for RS 232	1997 501	50.00
		Cable DataVariable for Digimatic	1998 501	64.00
		Cable DataVariable for USB	1998 720	72.00
<b>Bidirectional (for suitable micrometers only)</b>				
		Data cable bidirectional DataVariable to USB	1998 801	98.00
		Data cable bidirectional DataVariable to Digimatic	1998 802	85.00

## 1998 Software MarCom Professional



### Model

**Software for easy data acquisition, for all measuring instruments with variable data output (DATA VARIABLE) and integrated wireless (IW)**

- Connection to more than 100 measuring instruments with USB data cable possible
- Data transmission with virtual interface box MUX 50 format possible
- Connection of two serial COM-interfaces possible
- Several foot switches via USB connectable, the measuring instruments can be freely assigned
- USB Hubs connectable as measuring instrument interface
- Wireless data transfer with Integrated Wireless (IW) devices
- Wireless data transfer via **blueDAT**

### System requirements

IBM AT compatible PC, MS Windows 7 / 8 / 10, USB-interface from version 2.0 MS EXCEL® from version 97

**DOWNLOAD FOR FREE**  
[www.helios-preisser.de](http://www.helios-preisser.de)

⏪	⏩	Description	Order no.
		MarCom Professional	1998 710



## 1998 i-Stick USB-receiver for Integrated Wireless



### integrated iW wireless Wireless Data Transmission



### Description

- **Measurement without the nuisance of additional modules:** Unlike conventional wireless solutions, which have a large external transmitter with separate battery, the transmitter in Integrated Wireless is fully integrated.
- **Highly mobile:** Integrated Wireless gives you much more mobility. There is no cable to get in the way, either at the measuring station or when measuring on or at the machine or at large workpieces
- **Easy data transfer:** With Integrated Wireless you can transfer your measured values to the PC simply using the i-Stick. As with a data cable, the measured values are accepted via the MarCom software directly into MS Excel© or via a keyboard code into any Windows application
- **Reliable transfer:** With Integrated Wireless you can be sure that your data will arrive safely. Measuring instruments with Integrated Wireless display messages to confirm whether the transmitted data has been correctly transferred or whether you are within receiving range of the i-Stick receiver
- **Long battery life:** The integrated wireless interface makes the measuring instrument exceptionally energy-efficient. And unlike conventional wireless systems, no additional battery is required
- **Affordable:** With Integrated Wireless you can connect up to 8 measuring instruments per i-Stick receiver. Expensive interface boxes are no longer necessary. With even one connected measuring instrument you get a wireless connection for the price of a cable

		Number of channels	Frequency band MHz	Radio range	Number of i-Sticks per workspace	Number of devices max.	For measuring instruments	Order no.	List price Euro EUR
		3	2400	up to 6 meters	4	32 (8 per i-Stick)	1326i / 1371i / 1726i / 1734i / 1866i	1998 780	95.00



## 1998 Accesories for data aquisition with MarCom



### Example: possible measuring station setup

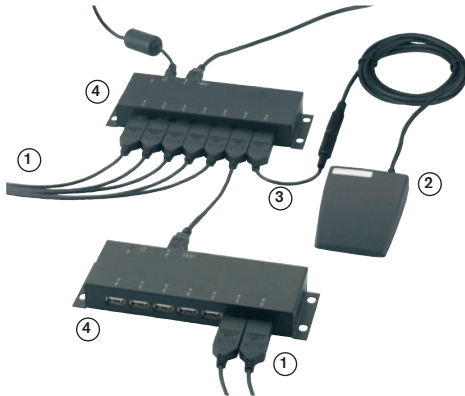

### Model

1. USB-cable to devices
2. Foot switch with jack plug
3. USB-adaptor-cable for foot switch
4. USB-hub for connecting several devices

	Description	Order no.	List price EUR
☒ ☒	Cable DataVariable for USB	1998 720	72.00
	USB-adapter cable for foot switch	1998 722	60.00
	USB-hub sevenfold with plug-in power supply	1998 730	120.00
	Foot-switch* (length of the cable 2 m)	1998 732	72.00

\* To connect to the MarCom, the USB-adapter cable Ref. No. 1998 722 is required

## 0996 Data cable opto RS232



	Description	Order no.	List price EUR
☒ ☒	Cable Opto for RS232	0996 701	77.00
	Cable Opto for USB	0996 705	147.00

## 1998 blueDAT - wireless data transmission (bluetooth)



### Model

Available for all DIGI-MET measuring instruments with a variable data output (DATA VARIABLE)

- Reach: approx. 10 m
- With a data transfer button on the plug-in jack

- USB receiver for use with MarCom Professional software to transfer the measured results to PC, laptop or workstation

	Description	Order no.	List price EUR
☒ ☒	blueDAT USB receiver	1998 740	101.00
	blueDAT for DATA Variable	1998 742	363.00
	blueDAT for RS 232 opto	1998 744	363.00
	blueDAT for RS 232 Proximity	1998 746	497.00
	blueDAT for RS 232 Power (Powered through cable)	1998 748	497.00



## 0997 USB-keyboard interface cable



(Menu) button



0997 770



0997 772



0997 774

### Model

- USB-keyboard interface and data cable are in one unit (length of the cable: 2 m)
- For connection of one unit
- Power supply via USB-Interface
- No driver file for the USB-Interface required
- The USB-Interface reveal themselves as a keyboard
- Terminators like Enter or Tab can be adjusted in the USB-Interface
- More settings such as language, separator and timer
- Transmit data using either the data-switch on measuring instrument or with a timer

	Description	Order no.	List price EUR
	USB-keyboard interface cable Opto RS 232	0997 770	251.00
	USB-keyboard interface RS 232 Proximity	0997 772	251.00
	USB-keyboard interface cable RS 232 Power (Power supply through data cable)	0997 774	306.00

## 0997 USB-keyboard interface „T-Box 302 USB“



### Model



4 RS 232 input ports



Connection for foot switch

- USB-keyboard interface for 4 x RS 232C input
- for simultaneous connection of up to 4 devices
- power supply via USB-port
- no driver file for the USB-Interface required
- the USB-Interface reveal themselves as a keyboard
- terminators like Enter or Tab can be adjusted in the USB-Interface
- more settings such as language, separator and timer
- measured results can be directly conveyed e.g. to EXCEL or other text processing or statistics programs.
- foot switch connector, transmit data on measuring instrument or cable for data transmission or with a timer

	Description	Order no.	List price EUR
	Keyboard interface T-Box 302 USB	0997 778	824.00





# CALIBRATIONS

**Traceable calibration certificates**  
directly from the **expert**

**Certificates** are already **included**  
for **selected products**

We are certified according to  
**DIN EN ISO 9001:2015**



## 8. CHAPTER CALIBRATION SERVICE ORDER NUMBER INDEX AND KEYWORD INDEX

282 Calibration service

286 Order number index

302 Keyword index





## Free initial calibration available with many of our products



All HELIOS-PREISSER measuring instruments with a  marked in the column (=Calibration), will undergo initial calibration and are supplied with a certificate at no extra charge! No separate order is required for these articles to be pre-calibrated on delivery. For all other gauges and measuring instruments, and for subsequent calibration, the following calibration services are offered. Testing is carried out in accordance with VDI / VDE / DGQ guidelines 26 ff.

## Calibration service





**Calipers / Depth gauges / Height gauges** analogue or digital (1 graduation)

		Max. measuring range	Order no.	List price
		mm		EUR
		150	4310 110	12.00
		300	4310 115	21.50
		500	4310 120	36.30
		1000	4310 125	77.00
		2000	4310 130	106.00
		3000	4310 135	166.00



**Micrometers according to DIN 863-1**

		Max. measuring range	Order no.	List price
		mm		EUR
		25	4320 210	20.40
		100	4320 212	27.50
		200	4320 214	29.90
		300	4320 220	33.10
		500	4320 224	36.60
		1000	4320 228	60.00

**Micrometers with interchangeable inserts** including setting standard

		Max. measuring range	Order no.	List price
		mm		EUR
		100	4320 810	128.00
		200	4320 814	182.00
		300	4320 818	195.00
		400	4320 822	200.00
		500	4320 826	200.00
		600	4320 830	200.00
		700	4320 834	255.00
		800	4320 838	255.00
		900	4320 842	255.00
		1000	4320 846	255.00
		1200	4320 850	303.00
		1400	4320 854	303.00
		1600	4320 858	362.00
		1800	4320 862	362.00
		2000	4320 866	362.00

**DAkKS Calibration for Calipers / Depth gauges** analogue or digital (1 graduation)

		Max. measuring range	Order no.	List price
		mm		EUR
<b>Pocket and workshop calipers</b>				
		300	4380 110	31.70
		500	4380 112	46.00
		1000	4380 114	85.00
<b>Depth gauges</b>				
		300	4380 120	31.00
		500	4380 122	46.00
		1000	4380 124	85.00
<b>Depth gauges with hook</b>				
		300	4380 130	44.00
		500	4380 132	71.00
		1000	4380 134	86.00



**DAkKS Calibration for micrometers according to DIN 863-1** analogue or digital (1 graduation)

		Measuring range	Order no.	List price
		mm		EUR
		0 - 25	4380 140	42.00
		0 - 100	4380 142	45.50

**DAkKS Calibration for micrometer setting standards**

		Max. measuring range	Order no.	List price
		mm		EUR
		500	4380 149	88.50

**Setting standards for micrometers** Tolerance zone js2

		Max. measuring range	Order no.	List price
		mm		EUR
		100	4329 010	7.30
		275	4329 026	16.70
		1000	4329 046	33.30



## Calibration service



### Indicators, analogue and digital, readings/resolution 0.01 and 0.001

	Measuring span	Order no.	List price
	mm		EUR
	13	4360 210	25.30
	30	4360 212	36.30
	50	4360 214	41.20
	100	4360 218	53.00

### DAkKS Calibration for Indicators, analogue and digital, readings/resolution 0.01 and 0.001

	Measuring span	Order no.	List price
	mm		EUR
	Up to 10	4380 150	52.70
	10	4380 151	55.80
	30	4380 152	66.00
	50	4380 154	75.50
	100	4380 156	107.00

### Internal micrometers analogue and digital

	Max. measuring range	Order no.	List price
	mm		EUR
	0 - 100	4322 810	45.50
	100 - 200	4322 814	90.00
	200 - 300	4322 818	112.00

### DAkKS Calibration for internal micrometers analogue and digital

	Max. measuring range	Order no.	List price
	mm		EUR
	2 - 100	4380 160	68.00

### Universal bevel protractor analogue or digital (1 blade)

	Max. measuring range	Order no.	List price
	in °		EUR
	360	4342 610	27.50

### DAkKS Calibration for universal bevel protractor analogue or digital (1 blade)

	Max. measuring range	Order no.	List price
	in °		EUR
	360	4380 170	80.50

### Protractor

	Order no.	List price
		EUR
	4342 410	12.00



## Calibration service



### Squares with and without base, knife edge squares according to DIN 875 all accuracies

	Max. length mm	Order no.	List price EUR
	100	4340 210	15.60
	200	4340 214	17.20
	500	4340 218	25.30
	750	4340 222	43.30
	1000	4340 226	52.00
	1500	4340 230	77.00

### Rules according to DIN 866 Form A / B

	Max. length mm	Order no.	List price EUR
	500	4350 210	31.40
	1000	4350 218	51.00
	1500	4350 226	77.00
	2000	4350 232	100.00
	3000	4350 238	140.00

### Flat rules according to DIN 874 Part 1 all accuracies

	Max. length mm	Order no.	List price EUR
	500	4351 610	26.20
	1000	4351 618	61.00
	2000	4351 628	91.00
	3000	4351 638	116.00

### Knife edge rules according to DIN 874 Part 2 all accuracies

	Max. length mm	Order no.	List price EUR
	200	4352 412	14.90
	500	4352 418	23.70
	1000	4352 422	44.80

### Levels

	Max. length mm	Order no.	List price EUR
	300	4353 410	54.00

### Frame levels

	Max. length mm	Order no.	List price EUR
	300	4353 510	76.00

### Parallel gauge blocks

	Max. nominal size	Order no.	List price EUR
	100	4357 010	11.30
	300	4357 020	33.10

### Plug gauges. GO / NOGO master gauges

	Max. diameter mm	Order no.	List price EUR
	100	4357 610	11.50
	200	4357 620	19.50



## Calibration service



### Setting rings (master rings)

	Max. diameter mm	Order no.	List price EUR
	100	4358 410	17.20
	200	4358 420	30.30

### Dial test indicator

	Order no.	List price EUR
	4360 810	35.10

### Snap gauges. GO and NOGO

	Max. nominal size	Order no.	List price EUR
	100	4358 810	19.50

### Caliper gauges analogue and digital

	Order no.	List price EUR
	4361 410	53.00

### Thread plug gauges. GO / NOGO thread gauges

	Max. diameter mm	Order no.	List price EUR
	100	4359 210	24.80

### Thread master rings

	Max. diameter mm	Order no.	List price EUR
	100	4359 410	31.70



Order no.	Page	List price in €	Order no.	Page	List price in €	Order no.	Page	List price in €
0003217	83	7.70	0198501	17	30.50	0235511	39	601.00
0003219	83	7.70	0199501	17	30.50	0235514	39	692.00
0003220	83	9.20	0203501	18	52.00	0235518	39	817.00
0003221	83	11.60	0212520	22	133.00	0235522	39	1321.00
0003222	83	16.00	0212522	22	195.00	0235524	39	1681.00
0003223	83	17.90	0212524	22	195.00	0235526	39	2476.00
0003224	83	27.00	0212526	22	219.00	0236201	40	94.00
0003225	83	35.10	0212528	22	219.00	0236202	40	115.00
0003226	83	41.90	0217501	21	67.00	0236203	40	129.00
0003228	83	46.70	0217502	21	135.00	0236204	42	240.00
0003229	83	47.90	0218501	21	90.00	0236205	40	265.00
0003230	83	49.20	0220204	93	3.30	0236206	42	341.00
0003231	83	50.00	0220704	24	3.90	0236207	42	416.00
0003232	83	50.00	0220705	26	22.40	0236208	40	349.00
0003233	83	60.00	0222734	50	2677.00	0236209	42	463.00
0003235	83	73.00	0222736	50	3212.00	0236210	42	557.00
0003236	83	61.00	0223734	50	2856.00	0236211	40	418.00
0003237	83	66.00	0223736	50	3309.00	0236212	42	580.00
0003238	83	67.00	0224734	51	2421.00	0236213	42	714.00
0003239	83	75.00	0224736	51	2934.00	0236214	40	446.00
0003240	83	86.00	0225734	51	2552.00	0236215	42	671.00
0003241	83	86.00	0225736	51	3029.00	0236216	42	859.00
0003242	83	82.00	0228701	54	493.00	0236217	42	997.00
0003243	83	88.00	0228702	54	686.00	0236218	40	557.00
0003244	83	99.00	0228703	54	964.00	0236219	42	824.00
0003245	83	109.00	0228704	54	1137.00	0236220	42	920.00
0003246	83	118.00	0228724	54	2869.00	0236221	42	1387.00
0003247	83	135.00	0228726	54	3410.00	0236222	40	863.00
0003248	83	115.00	0230501	37	146.00	0236224	40	1176.00
0003249	83	115.00	0230502	37	163.00	0236225	42	1422.00
0003251	83	152.00	0230503	37	178.00	0236226	40	1621.00
0003252	83	165.00	0230508	37	510.00	0236227	42	1979.00
0003253	83	196.00	0231501	37	173.00	0236230	40	2682.00
0003254	83	255.00	0231502	37	190.00	0236231	42	3271.00
0003255	83	301.00	0231503	37	205.00	0236501	40	107.00
0003256	83	284.00	0231508	37	557.00	0236502	40	135.00
0003257	83	306.00	0234201	38	109.00	0236503	40	146.00
0003258	83	318.00	0234202	38	133.00	0236504	42	258.00
0003259	83	368.00	0234203	38	143.00	0236505	40	309.00
0003280	210	4.30	0234205	38	334.00	0236506	42	397.00
0003281	210	4.70	0234208	38	419.00	0236507	42	482.00
0003282	210	4.90	0234211	38	490.00	0236508	40	407.00
0003283	210	6.10	0234214	38	557.00	0236509	42	536.00
0003284	210	6.80	0234218	38	676.00	0236510	42	640.00
0003285	210	7.70	0234222	38	1082.00	0236511	40	487.00
0003286	210	9.00	0234224	38	1398.00	0236512	42	605.00
0003287	210	8.50	0234226	38	2042.00	0236513	42	788.00
0003288	210	19.30	0234501	38	129.00	0236514	40	504.00
0003289	210	11.60	0234502	38	149.00	0236515	42	779.00
0003290	210	19.30	0234503	38	164.00	0236516	42	994.00
0003291	210	33.30	0234505	38	379.00	0236517	42	1166.00
0003292	210	36.80	0234508	38	489.00	0236518	40	629.00
0003293	210	37.10	0234511	38	554.00	0236519	42	956.00
0003294	210	41.50	0234514	38	628.00	0236520	42	1206.00
0145110	28	171.00	0234518	38	754.00	0236521	42	1647.00
0180310	20	4.40	0234522	38	1232.00	0236522	40	1034.00
0180320	20	7.10	0234524	38	1585.00	0236524	40	1387.00
0180330	20	7.10	0234526	38	2321.00	0236525	42	1692.00
0182501	19	34.50	0235201	39	138.00	0236526	40	2090.00
0184501	14	26.00	0235202	39	159.00	0236527	42	2506.00
0184505	14	34.50	0235203	39	168.00	0237201	41	121.00
0184508	14	51.00	0235205	39	387.00	0237202	41	143.00
0185500	14	20.00	0235208	39	471.00	0237203	41	156.00
0185501	14	26.00	0235211	39	540.00	0237204	43	266.00
0185505	14	34.50	0235214	39	619.00	0237205	41	317.00
0185508	14	51.00	0235218	39	721.00	0237206	43	393.00
0188501	15	23.00	0235222	39	1184.00	0237207	43	469.00
0189501	15	23.00	0235224	39	1495.00	0237208	41	403.00
0190501	18	27.00	0235226	39	2208.00	0237209	43	517.00
0194501	15	27.00	0235501	39	147.00	0237210	43	610.00
0195501	15	27.00	0235502	39	176.00	0237211	41	471.00
0197501	17	33.00	0235503	39	189.00	0237212	43	630.00
0197505	17	75.00	0235505	39	429.00	0237213	43	767.00
0197508	17	149.00	0235508	39	528.00	0237214	41	507.00

# Order number index



Order no.	Page	List price in €	Order no.	Page	List price in €	Order no.	Page	List price in €
0237215	43	737.00	0260502	62	74.00	0286508	67	388.00
0237216	43	922.00	0261516	19	224.00	0286509	67	523.00
0237217	43	1062.00	0262503	59	271.00	0286510	67	666.00
0237218	41	619.00	0268201	64	308.00	0292501	68	88.00
0237219	43	890.00	0268211	64	376.00	0292502	68	100.00
0237220	43	985.00	0268518	62	182.00	0294504	68	470.00
0237221	43	1450.00	0268522	62	195.00	0294505	68	750.00
0237222	41	961.00	0273731	82	205.00	0294506	68	1166.00
0237224	41	1275.00	0273732	82	212.00	0294507	68	1581.00
0237225	43	1521.00	0273735	82	229.00	0300007	178	2.10
0237226	41	1782.00	0273738	82	243.00	0300008	178	2.30
0237227	43	2138.00	0273741	82	295.00	0300009	178	1.10
0237230	41	2914.00	0273745	82	516.00	0300010	178	1.10
0237231	43	3502.00	0273746	82	562.00	0300011	178	2.10
0237501	41	132.00	0273751	82	368.00	0300013	178	10.20
0237502	41	162.00	0273752	82	373.00	0300014	178	3.50
0237503	41	174.00	0273755	82	396.00	0300102	178	5.60
0237504	43	283.00	0273758	82	417.00	0300103	178	10.30
0237505	41	362.00	0273761	82	448.00	0300112	178	4.70
0237506	43	448.00	0273765	82	629.00	0300114	178	8.80
0237507	43	534.00	0273766	82	676.00	0300120	178	12.80
0237508	41	457.00	0276711	71	6.40	0300130	178	3.40
0237509	43	586.00	0279722	73	272.00	0301001	179	7.30
0237510	43	691.00	0279723	73	284.00	0301002	179	8.30
0237511	41	536.00	0279724	73	296.00	0301003	179	9.20
0237512	43	704.00	0279724	73	21.50	0301004	179	12.80
0237513	43	841.00	0280501	65	61.00	0301005	179	15.50
0237514	41	567.00	0281201	65	81.00	0301006	179	41.90
0237515	43	843.00	0281202	65	84.00	0301007	179	59.00
0237516	43	1055.00	0281204	65	94.00	0301008	179	78.00
0237517	43	1231.00	0281205	65	106.00	0301009	179	109.00
0237518	41	693.00	0281501	65	89.00	0301010	179	160.00
0237519	43	1016.00	0281502	65	92.00	0302001	179	10.70
0237520	43	1269.00	0281504	65	105.00	0302002	179	11.80
0237521	43	1713.00	0281505	65	115.00	0302003	179	12.60
0237522	41	1128.00	0282201	66	72.00	0302004	179	16.50
0237524	41	1484.00	0282202	66	74.00	0302005	179	21.60
0237525	43	1792.00	0282203	66	85.00	0302006	179	60.00
0237526	41	2249.00	0282204	66	82.00	0302007	179	74.00
0237527	43	2663.00	0282205	66	90.00	0302008	179	95.00
0238503	44	379.00	0282206	66	101.00	0302009	179	132.00
0238508	44	542.00	0282207	66	139.00	0302010	179	183.00
0238514	44	724.00	0282208	66	214.00	0303001	184	7.10
0238518	44	848.00	0282209	66	352.00	0303002	184	7.70
0238524	44	2199.00	0282210	66	500.00	0303003	184	8.80
0238526	44	2560.00	0282212	66	1221.00	0303004	184	9.40
0250101	57	5.90	0282213	66	1605.00	0303005	184	10.70
0250102	57	11.90	0282501	66	78.00	0303006	184	13.10
0250103	57	16.30	0282502	66	82.00	0303007	184	16.30
0250201	57	59.00	0282503	66	93.00	0303008	184	24.60
0250202	57	85.00	0282504	66	90.00	0303009	184	35.40
0250501	57	255.00	0282505	66	99.00	0303010	184	65.00
0250511	57	275.00	0282506	66	112.00	0304001	184	7.10
0250521	57	275.00	0282507	66	152.00	0304002	184	7.70
0250531	57	275.00	0282508	66	232.00	0304003	184	8.80
0250541	57	275.00	0282509	66	387.00	0304004	184	9.40
0250551	57	275.00	0282510	66	548.00	0304005	184	10.70
0250561	57	275.00	0286201	67	85.00	0304006	184	13.10
0250571	57	289.00	0286202	67	88.00	0304007	184	16.30
0252201	60	143.00	0286204	67	99.00	0304008	184	24.60
0252202	60	275.00	0286205	67	106.00	0304009	184	35.40
0252203	60	301.00	0286206	67	131.00	0304010	184	65.00
0252291	60	4.40	0286207	67	167.00	0306001	179	13.70
0252293	60	5.40	0286208	67	279.00	0306003	179	15.50
0253300	60	84.00	0286209	67	438.00	0306005	179	24.20
0253301	60	84.00	0286210	67	607.00	0308201	183	94.00
0253302	60	107.00	0286212	67	1312.00	0308202	183	113.00
0253391	60	3.90	0286213	67	1691.00	0308303	183	138.00
0258501	61	144.00	0286501	67	93.00	0308305	183	163.00
0258502	61	192.00	0286502	67	94.00	0310101	180	3.60
0258503	61	295.00	0286504	67	108.00	0310102	180	4.00
0258504	61	333.00	0286505	67	115.00	0310103	180	4.40
0258505	61	372.00	0286506	67	142.00	0310105	180	4.90
0260501	62	74.00	0286507	67	184.00	0310107	180	6.30



## Order number index



Order no.	Page	List price in €	Order no.	Page	List price in €	Order no.	Page	List price in €
0310108	180	7.40	0322501	188	25.90	0369112	196	838.00
0311101	180	3.60	0322503	188	40.60	0369202	196	17.40
0311102	180	4.20	0322510	188	4.60	0369203	196	19.10
0311103	180	4.90	0323308	187	16.90	0369204	196	25.30
0311105	180	5.80	0323318	187	21.60	0369205	196	38.30
0311107	180	7.10	0331011	193	114.00	0369206	196	51.00
0311108	180	7.60	0331030	193	133.00	0369207	196	71.00
0311120	180	2.30	0331111	193	148.00	0369208	196	135.00
0311121	180	19.10	0331130	193	169.00	0369209	196	188.00
0311124	180	19.50	0334101	193	75.00	0369210	196	315.00
0312101	185	3.40	0334102	193	124.00	0369211	196	588.00
0312103	185	4.90	0334105	193	91.00	0369212	196	1103.00
0312105	185	5.90	0334106	193	138.00	0370102	198	12.00
0312107	185	7.30	0338354	193	146.00	0370103	198	13.50
0312108	185	8.80	0338357	193	190.00	0370104	198	18.00
0313101	185	3.40	0343501	186	266.00	0370105	198	22.50
0313103	185	4.90	0343503	186	299.00	0370106	198	30.00
0313105	185	5.90	0344501	186	130.00	0370107	198	37.00
0313107	185	7.30	0344502	186	166.00	0370108	198	99.00
0313108	185	8.80	0344503	186	210.00	0370109	198	145.00
0314002	183	77.00	0344505	186	446.00	0370110	198	205.00
0314003	183	88.00	0345522	190	389.00	0370111	198	410.00
0314004	183	92.00	0345530	190	487.00	0370112	198	690.00
0314005	183	98.00	0345534	190	670.00	0370202	198	16.00
0314102	183	117.00	0345722	191	562.00	0370203	198	19.00
0314103	183	139.00	0345730	191	702.00	0370204	198	26.00
0314104	183	143.00	0345734	191	973.00	0370205	198	35.00
0314105	183	148.00	0345910	190	124.00	0370206	198	49.00
0316110	181	7.70	0345912	190	138.00	0370207	198	63.00
0316111	181	30.30	0347522	190	497.00	0370208	198	168.00
0316151	181	130.00	0347530	190	627.00	0370209	198	206.00
0316152	181	164.00	0347534	190	865.00	0370210	198	350.00
0316153	181	198.00	0347722	191	692.00	0370211	198	542.00
0316154	181	254.00	0347730	191	865.00	0370212	198	876.00
0316201	181	147.00	0347734	191	1190.00	0371102	198	8.50
0316202	181	203.00	0349722	192	594.00	0371103	198	9.50
0317001	182	68.00	0349730	192	756.00	0371104	198	11.50
0317002	182	96.00	0349734	192	1027.00	0371105	198	16.00
0317003	182	124.00	0349910	192	114.00	0371106	198	22.50
0317004	182	170.00	0349912	192	133.00	0371107	198	29.00
0317005	182	391.00	0349914	192	148.00	0371108	198	69.00
0317006	182	636.00	0349916	192	169.00	0371109	198	90.00
0317007	182	839.00	0368102	196	16.00	0371110	198	125.00
0317010	182	8.40	0368103	196	18.70	0371111	198	280.00
0317101	182	81.00	0368104	196	28.20	0371112	198	480.00
0317102	182	109.00	0368105	196	36.20	0371202	198	9.40
0317103	182	142.00	0368106	196	52.00	0371203	198	11.40
0317104	182	184.00	0368107	196	71.00	0371204	198	16.00
0317105	182	407.00	0368108	196	154.00	0371205	198	22.20
0317106	182	641.00	0368109	196	225.00	0371206	198	32.30
0317107	182	844.00	0368110	196	322.00	0371207	198	39.40
0317110	182	24.00	0368111	196	550.00	0371208	198	130.00
0318201	188	154.00	0368112	196	987.00	0371209	198	163.00
0318203	188	164.00	0368202	196	24.00	0371210	198	269.00
0318210	188	13.00	0368203	196	25.80	0371211	198	493.00
0318211	188	42.20	0368204	196	44.40	0371212	198	795.00
0319001	189	36.80	0368205	196	64.00	0372102	199	10.20
0319002	189	46.10	0368206	196	93.00	0372103	199	11.50
0319003	189	66.00	0368207	196	104.00	0372104	199	15.00
0319004	189	89.00	0368208	196	195.00	0372105	199	19.00
0319010	189	3.90	0368209	196	270.00	0372106	199	25.50
0319101	189	47.10	0368210	196	401.00	0372107	199	32.00
0319102	189	55.00	0368211	196	689.00	0372108	199	53.00
0319103	189	76.00	0368212	196	1462.00	0372109	199	70.00
0319104	189	96.00	0369102	196	10.50	0372110	199	95.00
0319510	189	40.00	0369103	196	11.80	0372111	199	120.00
0320001	189	46.10	0369104	196	14.50	0372112	199	165.00
0320002	189	89.00	0369105	196	24.00	0372113	199	590.00
0320101	189	72.00	0369106	196	33.10	0372114	199	950.00
0320102	189	113.00	0369107	196	42.50	0373102	199	7.20
0321301	187	22.70	0369108	196	104.00	0373103	199	8.00
0321302	187	25.40	0369109	196	128.00	0373104	199	11.00
0321303	187	25.90	0369110	196	253.00	0373105	199	13.00
0321305	187	49.30	0369111	196	470.00	0373106	199	18.00

# Order number index



Order no.	Page	List price in €	Order no.	Page	List price in €	Order no.	Page	List price in €
0373107	199	23.00	0387201	204	17.90	0396435	209	19.00
0373108	199	36.00	0388102	203	20.20	0396436	209	21.20
0373109	199	52.00	0388103	203	24.00	0396443	208	10.50
0373110	199	70.00	0388104	203	28.70	0396444	208	12.40
0373111	199	94.00	0388105	203	38.60	0396445	208	13.40
0373112	199	135.00	0388106	203	54.00	0396446	208	17.30
0373113	199	525.00	0388108	203	94.00	0396453	208	13.20
0373114	199	840.00	0388202	203	24.00	0396454	208	14.90
0374404	200	7.00	0388203	203	28.20	0396455	208	16.60
0374408	200	7.90	0388204	203	34.00	0396456	208	20.30
0374410	200	9.50	0388205	203	43.90	0396982	209	11.90
0374412	200	11.50	0388206	203	65.00	0396983	209	14.10
0374414	200	14.00	0388208	203	142.00	0396984	209	16.80
0374416	200	17.70	0388210	203	676.00	0397101	204	184.00
0374418	200	23.50	0390102	202	36.20	0411101	211	22.60
0374420	200	31.50	0390103	202	36.20	0411102	211	28.20
0374424	200	37.50	0390104	202	41.90	0411103	211	35.40
0374428	200	57.00	0390105	202	53.00	0411104	211	46.90
0374430	200	199.00	0390106	202	72.00	0411105	211	71.00
0374432	200	292.00	0390108	202	121.00	0411106	211	82.00
0375404	200	5.70	0390202	202	47.90	0411107	211	108.00
0375408	200	6.00	0390203	202	54.00	0411108	211	140.00
0375410	200	6.40	0390204	202	69.00	0411109	211	148.00
0375412	200	7.80	0390205	202	89.00	0411110	211	154.00
0375414	200	8.50	0390206	202	111.00	0411301	211	25.10
0375416	200	11.70	0390208	202	171.00	0411302	211	32.30
0375418	200	13.00	0391102	202	56.00	0411303	211	35.90
0375420	200	15.90	0391103	202	56.00	0411304	211	52.00
0375424	200	18.90	0391104	202	73.00	0411305	211	103.00
0375428	200	24.50	0391105	202	92.00	0411306	211	130.00
0375430	200	96.00	0391106	202	124.00	0411307	211	141.00
0375432	200	145.00	0391108	202	181.00	0411308	211	147.00
0376102	201	12.30	0391202	202	67.00	0411309	211	155.00
0376103	201	13.10	0391203	202	75.00	0411310	211	191.00
0376104	201	16.50	0391204	202	85.00	0412201	211	35.40
0376105	201	27.10	0391205	202	109.00	0412202	211	38.30
0376112	201	11.50	0391206	202	140.00	0412203	211	39.40
0376113	201	12.20	0391208	202	227.00	0412204	211	55.00
0376114	201	14.80	0394101	203	212.00	0413301	212	23.90
0376115	201	20.70	0394104	203	38.30	0413302	212	24.90
0376116	201	25.60	0394110	203	85.00	0415301	212	65.00
0376117	201	30.50	0395102	207	28.00	0415302	212	101.00
0380103	205	57.00	0395103	207	31.10	0415303	212	137.00
0380104	205	68.00	0395104	207	41.90	0415304	212	188.00
0380105	205	85.00	0395106	207	19.70	0415305	212	213.00
0380106	205	94.00	0395107	207	21.60	0416301	213	130.00
0380107	205	102.00	0395108	207	31.10	0416302	213	170.00
0380108	205	262.00	0395122	207	26.50	0416303	213	220.00
0380109	205	466.00	0395123	207	30.30	0416304	213	364.00
0385102	197	25.30	0395124	207	40.60	0416305	213	422.00
0385103	197	27.00	0395126	207	19.00	0420121	215	16.30
0385104	197	32.30	0395127	207	21.20	0420122	215	63.00
0385105	197	48.20	0395128	207	29.80	0420124	215	89.00
0385106	197	67.00	0395132	206	8.60	0420201	215	56.00
0385108	197	117.00	0395133	206	11.00	0420202	215	60.00
0385202	197	35.10	0395134	206	13.30	0420203	215	65.00
0385203	197	39.00	0395136	206	8.60	0420206	215	18.40
0385204	197	48.20	0395137	206	11.00	0420207	215	19.30
0385205	197	64.00	0395138	206	13.30	0420208	215	19.50
0385206	197	82.00	0395142	206	19.10	0422501	213	151.00
0385208	197	121.00	0395143	206	21.60	0422502	213	159.00
0386102	197	19.10	0395144	206	28.20	0422503	213	168.00
0386103	197	20.50	0395146	206	14.10	0422504	213	176.00
0386104	197	25.10	0395147	206	19.10	0422590	213	19.50
0386105	197	31.10	0395148	206	25.80	0425211	214	28.70
0386106	197	40.10	0396290	208	96.00	0425212	214	32.30
0386108	197	77.00	0396414	205	16.50	0425213	214	36.20
0386202	197	24.20	0396416	205	19.50	0425214	214	51.00
0386203	197	27.40	0396418	205	23.00	0425701	214	1177.00
0386204	197	32.30	0396420	205	29.00	0425702	214	1188.00
0386205	197	41.90	0396426	205	35.00	0425703	214	1198.00
0386206	197	54.00	0396432	209	9.80	0451101	220	25.80
0386208	197	107.00	0396433	209	12.10	0451102	220	59.00
0387200	204	17.90	0396434	209	14.80	0451103	220	106.00

## Order number index



Order no.	Page	List price in €	Order no.	Page	List price in €	Order no.	Page	List price in €
0451104	220	147.00	0460213	218	111.00	0465205	224	604.00
0451105	220	304.00	0460221	218	1.10	0465206	224	920.00
0451106	220	552.00	0460222	218	1.10	0465207	224	1772.00
0451201	220	45.70	0460223	218	1.60	0465208	224	2610.00
0451202	220	105.00	0460224	218	1.60	0466101	223	22.20
0451203	220	156.00	0460225	218	4.30	0466102	223	39.00
0451204	220	274.00	0460226	218	9.20	0466103	223	44.40
0451205	220	552.00	0460227	218	3.20	0466104	223	85.00
0451206	220	998.00	0460228	218	7.70	0466105	223	116.00
0452101	220	20.30	0460229	218	16.00	0466106	223	256.00
0452103	220	40.10	0460230	218	25.80	0466107	223	400.00
0452104	220	58.00	0460231	218	31.10	0466108	223	951.00
0452105	220	95.00	0460232	218	72.00	0466109	223	1433.00
0452106	220	150.00	0460233	218	111.00	0466201	224	38.30
0452107	220	166.00	0460241	218	1.10	0466202	224	67.00
0452108	220	317.00	0460242	218	1.10	0466203	224	98.00
0452109	220	570.00	0460243	218	1.60	0466204	224	204.00
0452201	220	27.10	0460244	218	1.60	0466205	224	344.00
0452203	220	59.00	0460245	218	4.30	0466206	224	572.00
0452204	220	101.00	0460246	218	9.20	0466207	224	817.00
0452205	220	160.00	0460247	218	3.20	0466208	224	1521.00
0452206	220	306.00	0460248	218	7.70	0466209	224	2280.00
0452207	220	318.00	0460249	218	16.00	0467011	226	647.00
0452208	220	572.00	0460250	218	25.80	0467012	226	925.00
0452209	220	1090.00	0460251	218	31.10	0467013	226	1205.00
0453422	219	8.90	0460252	218	72.00	0467014	226	1552.00
0453430	219	13.20	0460253	218	111.00	0467015	226	2597.00
0453434	219	19.50	0460501	219	2.70	0467016	226	3609.00
0454424	222	9.40	0460502	219	4.30	0467017	226	6266.00
0454428	222	11.70	0460504	219	4.90	0467111	226	476.00
0454434	222	23.20	0460505	219	10.70	0467112	226	642.00
0454438	222	42.20	0460506	219	21.80	0467113	226	857.00
0454440	222	64.00	0460507	219	5.60	0467114	226	1172.00
0454444	222	169.00	0460508	219	11.80	0467115	226	1579.00
0455424	222	17.30	0460509	219	24.60	0467116	226	2078.00
0455428	222	21.60	0460510	219	72.00	0467117	226	3293.00
0455434	222	41.00	0460511	219	113.00	0478012	227	172.00
0455438	222	73.00	0460512	219	237.00	0478015	227	301.00
0455440	222	107.00	0460521	219	2.70	0478016	227	379.00
0455444	222	226.00	0460522	219	4.30	0478017	227	491.00
0458102	221	38.30	0460524	219	4.90	0478112	227	135.00
0458103	221	45.70	0460525	219	10.70	0478115	227	223.00
0458104	221	59.00	0460526	219	21.80	0478116	227	301.00
0458105	221	71.00	0460527	219	5.60	0478117	227	379.00
0458106	221	85.00	0460528	219	11.80	0478118	227	423.00
0458107	221	98.00	0460529	219	24.60	0478119	227	546.00
0458108	221	242.00	0464101	223	66.00	0478121	227	602.00
0458109	221	259.00	0464102	223	94.00	0478124	227	1002.00
0458110	221	333.00	0464103	223	147.00	0478127	227	1782.00
0458111	221	511.00	0464104	223	248.00	0478312	226	101.00
0458112	221	521.00	0464105	223	445.00	0478315	226	162.00
0458113	221	531.00	0464106	223	756.00	0478316	226	195.00
0458202	221	68.00	0464107	223	1161.00	0478317	226	233.00
0458203	221	86.00	0464108	223	1995.00	0478318	226	301.00
0458204	221	105.00	0464201	224	104.00	0478319	226	446.00
0458205	221	139.00	0464202	224	142.00	0478321	226	491.00
0458206	221	168.00	0464203	224	268.00	0478324	226	701.00
0458252	221	307.00	0464204	224	445.00	0478327	226	1114.00
0458253	221	323.00	0464205	224	823.00	0478907	227	287.00
0458254	221	344.00	0464206	224	1433.00	0478908	227	287.00
0458255	221	396.00	0464207	224	2534.00	0478909	227	307.00
0458256	221	432.00	0464208	224	4520.00	0478911	227	323.00
0458291	221	431.00	0465101	223	32.30	0478914	227	365.00
0460201	218	1.10	0465102	223	53.00	0478917	227	438.00
0460202	218	1.10	0465103	223	72.00	0481023	228	315.00
0460204	218	1.60	0465104	223	132.00	0481024	228	455.00
0460205	218	4.30	0465105	223	268.00	0481025	228	685.00
0460206	218	9.20	0465106	223	502.00	0481028	228	1137.00
0460207	218	3.20	0465107	223	862.00	0481030	228	1298.00
0460208	218	7.70	0465108	223	1393.00	0481034	228	2142.00
0460209	218	16.00	0465201	224	59.00	0481043	228	268.00
0460210	218	25.80	0465202	224	91.00	0481044	228	391.00
0460211	218	31.10	0465203	224	164.00	0481045	228	580.00
0460212	218	72.00	0465204	224	256.00	0481048	228	974.00

## Order number index



Order no.	Page	List price in €	Order no.	Page	List price in €	Order no.	Page	List price in €
0481050	228	1235.00	0522102	232	249.00	0580111	239	10.70
0481054	228	1947.00	0522103	232	359.00	0580121	239	7.50
0481103	228	229.00	0522111	233	20.50	0580151	239	3.10
0481104	228	332.00	0522112	233	27.10	0581101	241	21.60
0481105	228	506.00	0522113	233	34.60	0581103	241	14.60
0481108	228	844.00	0522201	232	133.00	0581105	241	20.00
0481110	228	1123.00	0522202	232	162.00	0581123	241	10.50
0481114	228	1787.00	0522203	232	233.00	0581125	241	9.20
0481160	228	353.00	0522206	232	253.00	0582110	241	61.00
0481161	228	366.00	0522207	232	308.00	0582120	241	61.00
0481162	228	386.00	0522208	232	443.00	0582130	242	61.00
0481165	228	412.00	0524101	233	225.00	0584101	254	317.00
0481167	228	431.00	0524102	233	278.00	0589101	242	16.90
0481170	228	490.00	0524103	233	418.00	0589103	242	52.00
0481184	229	1144.00	0525101	235	120.00	0590101	242	1.80
0481186	229	1260.00	0525102	235	128.00	0590111	242	65.00
0481188	229	1308.00	0525103	235	137.00	0590151	243	3.40
0481190	229	1462.00	0527101	234	340.00	0595101	244	21.20
0482101	229	488.00	0527102	234	471.00	0595110	243	13.20
0504012	230	93.00	0527104	234	668.00	0595115	243	3.80
0504013	230	145.00	0527105	234	934.00	0595130	240	3.10
0504014	230	223.00	0527106	234	275.00	0595140	240	2.70
0504112	230	66.00	0527107	234	403.00	0595142	240	2.70
0504113	230	88.00	0527108	234	562.00	0595251	243	91.00
0504114	230	145.00	0527109	234	550.00	0597301	63	175.00
0504312	230	45.50	0527110	234	858.00	0597305	63	175.00
0504313	230	67.00	0527111	234	1111.00	0598101	245	48.80
0504314	230	110.00	0527151	235	180.00	0598103	245	48.80
0508011	231	307.00	0527156	235	355.00	0598105	245	48.80
0508012	231	370.00	0536201	236	391.00	0598601	245	48.80
0508013	231	542.00	0536202	236	438.00	0599101	245	48.80
0508111	231	266.00	0536211	236	546.00	0599102	245	59.00
0508112	231	328.00	0536212	236	645.00	0599151	245	7.10
0508113	231	500.00	0536213	236	650.00	0599152	245	7.10
0512101	225	10.50	0536220	236	103.00	0600101	246	25.80
0512102	225	11.80	0536230	236	141.00	0600102	246	32.30
0512103	225	13.30	0544101	229	346.00	0600103	246	34.60
0512104	225	15.10	0544102	229	534.00	0600111	246	55.00
0512105	225	19.70	0544103	229	739.00	0600112	246	73.00
0512106	225	37.10	0544104	229	934.00	0600113	246	152.00
0512107	225	66.00	0544105	229	1588.00	0600114	246	237.00
0512108	225	104.00	0544106	229	2392.00	0600115	246	380.00
0512201	225	13.70	0544107	229	4565.00	0601103	246	91.00
0512202	225	16.00	0550021	237	266.00	0601120	246	69.00
0512203	225	16.70	0550022	237	292.00	0604002	246	6.80
0512204	225	18.70	0550023	237	318.00	0604004	246	7.50
0512205	225	21.60	0550024	237	344.00	0604006	246	7.50
0512206	225	46.90	0550101	237	188.00	0604013	247	53.00
0512207	225	85.00	0550102	237	214.00	0604014	247	53.00
0512208	225	116.00	0550103	237	240.00	0604015	247	53.00
0512209	225	224.00	0550104	237	266.00	0604016	247	53.00
0512210	225	454.00	0550131	237	146.00	0604017	247	53.00
0512211	225	595.00	0550132	237	172.00	0604018	247	53.00
0512601	225	5.40	0550133	237	198.00	0604019	247	53.00
0512602	225	5.40	0550134	237	224.00	0604020	247	53.00
0512603	225	5.40	0551002	237	281.00	0604021	247	53.00
0512604	225	6.50	0551003	237	336.00	0604022	247	53.00
0512605	225	7.60	0551012	237	178.00	0604023	247	53.00
0512606	225	8.60	0551013	237	200.00	0604024	247	53.00
0512607	225	10.80	0551021	237	168.00	0604025	247	34.40
0512608	225	16.30	0556022	238	511.00	0604026	247	34.40
0512609	225	16.30	0556023	238	584.00	0604027	247	34.40
0512610	225	32.50	0556024	238	823.00	0604028	247	34.40
0512611	225	37.90	0556101	238	313.00	0604029	247	34.40
0513001	230	172.00	0556102	238	365.00	0604030	247	34.40
0513002	230	198.00	0556103	238	458.00	0604031	247	34.40
0513011	230	188.00	0556104	238	729.00	0604032	247	34.40
0513012	230	219.00	0556131	238	261.00	0604033	247	34.40
0520101	231	133.00	0556132	238	313.00	0604034	247	34.40
0520102	231	175.00	0556133	238	479.00	0604035	247	34.40
0520103	231	232.00	0556134	238	573.00	0604036	247	34.40
0520104	231	324.00	0560001	238	306.00	0604037	247	36.20
0520105	231	443.00	0563001	238	417.00	0604038	247	36.20
0522101	232	204.00	0580101	239	7.40	0604039	247	36.20

## Order number index



Order no.	Page	List price in €	Order no.	Page	List price in €	Order no.	Page	List price in €
0604040	247	36.20	0606127	248	1.60	0612515	250	8.00
0604041	247	36.20	0606130	248	2.50	0612518	250	10.30
0604042	247	36.20	0606131	248	6.10	0612520	250	8.00
0604043	247	36.20	0606132	248	3.00	0612525	250	8.00
0604044	247	36.20	0606133	248	5.60	0613107	253	68.00
0604045	247	36.20	0606136	248	5.10	0613109	253	36.70
0604046	247	36.20	0606150	249	3.40	0613114	253	25.80
0604047	247	38.10	0606152	249	4.10	0613116	253	25.80
0604048	247	38.10	0606154	249	5.90	0613118	253	25.80
0604049	247	38.10	0606160	249	8.90	0613120	253	17.60
0604050	247	38.10	0606162	249	10.20	0613122	253	17.60
0604051	247	38.10	0606170	249	10.70	0613126	253	17.60
0604052	247	38.10	0606172	249	13.50	0613128	253	17.60
0604053	247	38.10	0606176	249	17.90	0613130	253	18.20
0604054	247	38.10	0606178	249	26.20	0613134	253	18.20
0604055	247	38.10	0607201	248	3.90	0613138	253	18.20
0604056	247	38.10	0607202	248	6.10	0613142	253	18.20
0604057	247	39.70	0607203	248	8.80	0613146	253	20.20
0604058	247	39.70	0607401	248	6.60	0613150	253	20.20
0604059	247	39.70	0607402	248	8.10	0613152	253	32.30
0604060	247	39.70	0607403	248	11.60	0613154	253	32.30
0604061	247	39.70	0608140	249	1.90	0613156	253	32.30
0604062	247	39.70	0608143	249	4.60	0613158	253	32.30
0604063	247	39.70	0608144	249	7.20	0613160	253	32.30
0604064	247	39.70	0608149	249	16.60	0613207	253	98.00
0604065	247	39.70	0609190	254	82.00	0613209	253	53.00
0604066	247	39.70	0611180	251	155.00	0613214	253	37.10
0604067	247	43.30	0611190	251	176.00	0613216	253	37.10
0604068	247	43.30	0611195	250	2.70	0613218	253	37.10
0604069	247	43.30	0611197	250	39.00	0613220	253	25.30
0604070	247	43.30	0611198	250	59.00	0613222	253	25.30
0604071	247	43.30	0611300	251	79.00	0613226	253	25.30
0604072	247	43.30	0611501	251	31.30	0613228	253	25.30
0604073	247	43.30	0611502	251	25.90	0613230	253	26.30
0604074	247	43.30	0611503	251	9.00	0613232	253	26.30
0604075	247	43.30	0611504	251	9.00	0613234	253	26.30
0604076	247	43.30	0611505	251	6.80	0613236	253	26.30
0604077	247	52.00	0611506	251	7.10	0613238	253	26.30
0604078	247	52.00	0611507	251	7.10	0613240	253	26.30
0604079	247	52.00	0611508	251	7.10	0613242	253	26.30
0604080	247	52.00	0611509	251	7.10	0613244	253	28.70
0604081	247	52.00	0611510	251	6.00	0613246	253	28.70
0604082	247	52.00	0611512	251	6.00	0613248	253	28.70
0604083	247	52.00	0611515	251	6.00	0613250	253	28.70
0604084	247	52.00	0611518	251	7.90	0613252	253	46.70
0604085	247	52.00	0611520	251	6.00	0613254	253	46.70
0604086	247	52.00	0611525	251	6.00	0613256	253	46.70
0604087	247	56.00	0611530	251	7.00	0613258	253	46.70
0604088	247	59.00	0611535	251	7.00	0613260	253	46.70
0604089	247	63.00	0611540	251	8.00	0613309	253	94.00
0604090	247	72.00	0611545	251	8.00	0613318	253	56.00
0604091	247	72.00	0611550	251	8.00	0613330	253	53.00
0604092	247	72.00	0611552	251	10.30	0613334	253	53.00
0604093	247	72.00	0611554	251	10.30	0613338	253	68.00
0604094	247	72.00	0611556	251	10.30	0613342	253	68.00
0604095	247	72.00	0611558	251	10.30	0613346	253	77.00
0604096	247	72.00	0611560	251	10.30	0613350	253	88.00
0604202	246	9.00	0611562	251	10.30	0613352	253	105.00
0604204	246	11.10	0611564	251	10.50	0613354	253	105.00
0604206	246	11.10	0611566	251	11.00	0613356	253	126.00
0605101	248	2.50	0611568	251	11.00	0613358	253	126.00
0605102	248	2.30	0611570	251	11.00	0613360	253	144.00
0605103	248	2.30	0612180	250	203.00	0613412	253	107.00
0605104	248	2.30	0612501	250	41.20	0613418	253	86.00
0605105	248	3.40	0612502	250	34.40	0613424	253	86.00
0605106	248	3.60	0612503	250	12.00	0613430	253	82.00
0605107	248	5.10	0612504	250	12.00	0613434	253	82.00
0605108	248	3.00	0612505	250	8.90	0613438	253	103.00
0605109	248	3.20	0612506	250	9.30	0613440	253	103.00
0605110	248	3.00	0612507	250	9.30	0613442	253	103.00
0605111	248	3.00	0612508	250	9.30	0613446	253	114.00
0605112	248	3.40	0612509	250	9.30	0613450	253	133.00
0606121	248	1.60	0612510	250	8.00	0613512	253	106.00
0606123	248	1.60	0612512	250	8.00	0613518	253	85.00

## Order number index



Order no.	Page	List price in €	Order no.	Page	List price in €	Order no.	Page	List price in €
0613524	253	85.00	0623114	255	35.70	0623475	255	45.40
0613530	253	81.00	0623116	255	35.70	0623500	255	45.40
0613534	253	81.00	0623118	255	35.70	0623510	255	45.40
0613538	253	101.00	0623120	255	35.70	0623520	255	45.40
0613540	253	101.00	0623122	255	35.70	0623530	255	45.40
0613542	253	101.00	0623130	255	35.70	0623540	255	45.40
0613546	253	113.00	0623135	255	35.70	0623550	255	45.40
0613550	253	132.00	0623140	255	35.70	0623560	255	45.40
0613607	252	68.00	0623145	255	35.70	0623570	255	45.40
0613609	252	36.70	0623150	255	35.70	0623580	255	45.40
0613614	252	25.80	0623155	255	35.70	0623590	255	45.40
0613616	252	25.80	0623160	255	35.70	0623600	255	45.40
0613618	252	25.80	0623165	255	35.70	0623610	255	45.40
0613620	252	17.60	0623170	255	35.70	0623620	255	45.40
0613622	252	17.60	0623175	255	35.70	0623630	255	45.40
0613626	252	17.60	0623180	255	35.70	0623640	255	45.40
0613628	252	17.60	0623185	255	35.70	0623650	255	54.00
0613630	252	18.20	0623190	255	35.70	0623660	255	54.00
0613632	252	18.20	0623195	255	35.70	0623670	255	54.00
0613634	252	18.20	0623200	255	35.70	0623680	255	54.00
0613636	252	18.20	0623205	255	35.70	0623690	255	54.00
0613638	252	18.20	0623210	255	35.70	0623700	255	54.00
0613640	252	18.20	0623215	255	35.70	0623710	255	67.00
0613642	252	18.20	0623220	255	35.70	0623720	255	67.00
0613644	252	20.20	0623225	255	35.70	0623730	255	80.00
0613646	252	20.20	0623230	255	35.70	0623740	255	283.00
0613648	252	20.20	0623235	255	35.70	0623750	255	283.00
0613650	252	20.20	0623240	255	35.70	0623760	255	283.00
0613652	252	32.30	0623245	255	35.70	0623770	255	338.00
0613654	252	32.30	0623250	255	35.70	0623780	255	482.00
0613656	252	32.30	0623255	255	35.70	0623790	255	626.00
0613658	252	32.30	0623260	255	35.70	0623800	255	866.00
0613660	252	32.30	0623265	255	35.70	0623810	255	1353.00
0613709	252	51.00	0623270	255	35.70	0623820	255	1403.00
0613718	252	30.60	0623275	255	35.70	0623830	255	1732.00
0613730	252	28.70	0623280	255	35.70	0623840	255	2053.00
0613734	252	28.70	0623285	255	35.70	0623850	255	2545.00
0613738	252	36.20	0623290	255	35.70	0624100	256	28.10
0613742	252	36.20	0623295	255	35.70	0624102	256	23.90
0613746	252	40.80	0623300	255	35.70	0624104	256	23.90
0613750	252	46.70	0623305	255	35.70	0624106	256	23.90
0613752	252	56.00	0623310	255	35.70	0624108	256	23.90
0613754	252	56.00	0623315	255	35.70	0624110	256	23.90
0613756	252	68.00	0623320	255	35.70	0624112	256	23.90
0613758	252	68.00	0623325	255	35.70	0624114	256	23.90
0613760	252	75.00	0623330	255	35.70	0624116	256	23.90
0613812	252	56.00	0623335	255	35.70	0624118	256	23.90
0613818	252	45.50	0623340	255	35.70	0624120	256	23.90
0613824	252	45.50	0623345	255	35.70	0624122	256	23.90
0613830	252	43.10	0623350	255	35.70	0624130	256	23.90
0613834	252	43.10	0623355	255	35.70	0624135	256	23.90
0613838	252	54.00	0623360	255	35.70	0624140	256	23.90
0613840	252	54.00	0623365	255	35.70	0624145	256	23.90
0613842	252	54.00	0623370	255	35.70	0624150	256	23.90
0613846	252	63.00	0623375	255	35.70	0624155	256	23.90
0613850	252	73.00	0623380	255	35.70	0624160	256	23.90
0613860	252	118.00	0623385	255	35.70	0624165	256	23.90
0613912	252	56.00	0623390	255	35.70	0624170	256	23.90
0613918	252	45.00	0623395	255	35.70	0624175	256	23.90
0613924	252	45.00	0623400	255	37.90	0624180	256	23.90
0613930	252	42.70	0623405	255	37.90	0624185	256	23.90
0613934	252	42.70	0623410	255	37.90	0624190	256	23.90
0613938	252	53.00	0623415	255	37.90	0624195	256	23.90
0613940	252	53.00	0623420	255	37.90	0624200	256	23.90
0613942	252	53.00	0623425	255	37.90	0624205	256	23.90
0613946	252	63.00	0623430	255	37.90	0624210	256	23.90
0613950	252	72.00	0623435	255	37.90	0624215	256	23.90
0623100	255	42.20	0623440	255	37.90	0624220	256	23.90
0623102	255	35.70	0623445	255	37.90	0624225	256	23.90
0623104	255	35.70	0623450	255	37.90	0624230	256	23.90
0623106	255	35.70	0623455	255	37.90	0624235	256	23.90
0623108	255	35.70	0623460	255	37.90	0624240	256	23.90
0623110	255	35.70	0623465	255	37.90	0624245	256	23.90
0623112	255	35.70	0623470	255	37.90	0624250	256	23.90

## Order number index



Order no.	Page	List price in €	Order no.	Page	List price in €	Order no.	Page	List price in €
0624255	256	23.90	0624790	256	379.00	0625405	257	19.50
0624260	256	23.90	0624800	256	525.00	0625410	257	19.50
0624265	256	23.90	0624810	256	730.00	0625415	257	19.50
0624270	256	23.90	0624820	256	758.00	0625420	257	19.50
0624275	256	23.90	0624830	256	937.00	0625425	257	19.50
0624280	256	23.90	0624840	256	1110.00	0625430	257	19.50
0624285	256	23.90	0624850	256	1375.00	0625435	257	19.50
0624290	256	23.90	0625100	257	22.70	0625440	257	19.50
0624295	256	23.90	0625102	257	19.50	0625445	257	19.50
0624300	256	23.90	0625104	257	19.50	0625450	257	19.50
0624305	256	23.90	0625106	257	19.50	0625455	257	19.50
0624310	256	23.90	0625108	257	19.50	0625460	257	19.50
0624315	256	23.90	0625110	257	19.50	0625465	257	19.50
0624320	256	23.90	0625112	257	19.50	0625470	257	19.50
0624325	256	23.90	0625114	257	19.50	0625475	257	23.90
0624330	256	23.90	0625116	257	19.50	0625500	257	23.90
0624335	256	23.90	0625118	257	19.50	0625510	257	23.90
0624340	256	23.90	0625120	257	19.50	0625520	257	23.90
0624345	256	23.90	0625122	257	19.50	0625530	257	23.90
0624350	256	23.90	0625130	257	19.50	0625540	257	23.90
0624355	256	23.90	0625135	257	19.50	0625550	257	23.90
0624360	256	23.90	0625140	257	19.50	0625560	257	23.90
0624365	256	23.90	0625145	257	19.50	0625570	257	23.90
0624370	256	23.90	0625150	257	19.50	0625580	257	23.90
0624375	256	23.90	0625155	257	19.50	0625590	257	23.90
0624380	256	23.90	0625160	257	19.50	0625600	257	23.90
0624385	256	23.90	0625165	257	19.50	0625610	257	23.90
0624390	256	23.90	0625170	257	19.50	0625620	257	23.90
0624395	256	23.90	0625175	257	19.50	0625630	257	23.90
0624400	256	24.90	0625180	257	19.50	0625640	257	23.90
0624405	256	24.90	0625185	257	19.50	0625650	257	28.10
0624410	256	24.90	0625190	257	19.50	0625660	257	28.10
0624415	256	24.90	0625195	257	19.50	0625670	257	28.10
0624420	256	24.90	0625200	257	19.50	0625680	257	28.10
0624425	256	24.90	0625205	257	19.50	0625690	257	28.10
0624430	256	24.90	0625210	257	19.50	0625700	257	28.10
0624435	256	24.90	0625215	257	19.50	0625710	257	35.70
0624440	256	24.90	0625220	257	19.50	0625720	257	35.70
0624445	256	24.90	0625225	257	19.50	0625730	257	42.20
0624450	256	24.90	0625230	257	19.50	0625740	257	138.00
0624455	256	24.90	0625235	257	19.50	0625750	257	138.00
0624460	256	24.90	0625240	257	19.50	0625760	257	138.00
0624465	256	24.90	0625245	257	19.50	0625770	257	147.00
0624470	256	24.90	0625250	257	19.50	0625780	257	232.00
0624475	256	30.30	0625255	257	19.50	0625790	257	273.00
0624500	256	30.30	0625260	257	19.50	0625800	257	357.00
0624510	256	30.30	0625265	257	19.50	0625810	257	444.00
0624520	256	30.30	0625270	257	19.50	0625820	257	530.00
0624530	256	30.30	0625275	257	19.50	0625830	257	656.00
0624540	256	30.30	0625280	257	19.50	0625840	257	777.00
0624550	256	30.30	0625285	257	19.50	0625850	257	963.00
0624560	256	30.30	0625290	257	19.50	0633001	260	314.00
0624570	256	30.30	0625295	257	19.50	0633014	262	889.00
0624580	256	30.30	0625300	257	19.50	0633016	262	812.00
0624590	256	30.30	0625305	257	19.50	0633018	262	528.00
0624600	256	30.30	0625310	257	19.50	0633020	262	386.00
0624610	256	30.30	0625315	257	19.50	0633114	262	684.00
0624620	256	30.30	0625320	257	19.50	0633116	262	521.00
0624630	256	30.30	0625325	257	19.50	0633118	262	322.00
0624640	256	30.30	0625330	257	19.50	0633120	262	234.00
0624650	256	35.70	0625335	257	19.50	0633130	258	1151.00
0624660	256	35.70	0625340	257	19.50	0633131	258	1337.00
0624670	256	35.70	0625345	257	19.50	0633132	258	1730.00
0624680	256	35.70	0625350	257	19.50	0633133	258	3417.00
0624690	256	35.70	0625355	257	19.50	0633136	260	182.00
0624700	256	35.70	0625360	257	19.50	0633137	260	208.00
0624710	256	44.40	0625365	257	19.50	0633138	260	250.00
0624720	256	44.40	0625370	257	19.50	0633139	260	229.00
0624730	256	53.00	0625375	257	19.50	0633140	260	271.00
0624740	256	172.00	0625380	257	19.50	0633141	260	313.00
0624750	256	172.00	0625385	257	19.50	0633142	260	354.00
0624760	256	172.00	0625390	257	19.50	0633143	260	386.00
0624770	256	204.00	0625395	257	19.50	0633144	260	448.00
0624780	256	293.00	0625400	257	19.50	0633145	260	625.00

# Order number index



Order no.	Page	List price in €	Order no.	Page	List price in €	Order no.	Page	List price in €
0633150	258	214.00	0636394	267	28.70	0649202	267	72.00
0633151	258	214.00	0636395	267	36.80	0649203	267	72.00
0633152	258	229.00	0636396	267	42.40	0649204	267	74.00
0633153	258	281.00	0637103	270	31.10	0649205	267	74.00
0633154	258	396.00	0637104	270	31.10	0649206	267	78.00
0633155	258	516.00	0637105	270	31.10	0649207	267	78.00
0633170	258	255.00	0637106	270	22.60	0649208	267	81.00
0633171	259	93.00	0637107	270	22.60	0649209	267	81.00
0633172	259	375.00	0637108	270	20.20	0649210	267	85.00
0633173	259	120.00	0637109	270	20.20	0649211	267	85.00
0633174	259	208.00	0637110	270	20.20	0649212	267	93.00
0633175	259	245.00	0637111	270	19.10	0649213	267	93.00
0633176	259	386.00	0637112	270	19.10	0649215	267	103.00
0633177	259	458.00	0637113	270	20.20	0649216	267	118.00
0633182	260	162.00	0637114	270	20.20	0649217	267	118.00
0633214	263	432.00	0637115	270	21.60	0649219	267	141.00
0633216	263	341.00	0637116	270	22.60	0649220	267	183.00
0633218	263	233.00	0637117	270	22.60	0649222	267	210.00
0633220	263	154.00	0637118	270	24.00	0649223	267	210.00
0633805	261	339.00	0637119	270	25.10	0650105	268	1731.00
0633808	261	453.00	0637120	270	25.10	0650106	268	1959.00
0633810	261	275.00	0637121	270	25.80	0650107	268	2247.00
0633833	36	563.00	0637122	270	25.80	0650108	268	2339.00
0633834	36	751.00	0637123	270	27.00	0650109	268	2482.00
0633836	36	1341.00	0637124	270	28.00	0650110	268	2686.00
0633838	36	2371.00	0637125	270	28.00	0650111	268	2883.00
0634014	264	4573.00	0637126	270	28.00	0650112	268	3081.00
0634016	264	3768.00	0637127	270	29.50	0650113	268	3280.00
0634017	264	2462.00	0637128	270	30.10	0650114	268	3545.00
0634020	264	1293.00	0637129	270	31.10	0656303	269	50.00
0634114	264	4025.00	0637130	270	31.10	0656304	269	75.00
0634116	264	3291.00	0637131	270	32.30	0656305	269	893.00
0634117	264	2206.00	0637132	270	33.60	0656306	269	983.00
0634120	264	1122.00	0637133	270	33.60	0656309	269	57.00
0634514	265	6385.00	0637134	270	34.60	0656310	269	50.00
0634516	265	5085.00	0637135	270	34.60	0656311	269	50.00
0634517	265	3032.00	0637136	270	38.30	0656312	269	50.00
0634520	265	1841.00	0637137	270	39.00	0656313	269	49.20
0634614	265	5345.00	0637138	270	40.10	0656314	269	47.90
0634616	265	4248.00	0637139	270	40.10	0656315	269	47.90
0634617	265	2534.00	0637140	270	41.10	0656316	269	47.90
0634620	265	1536.00	0637141	270	41.90	0656317	269	47.90
0636301	266	812.00	0637142	270	43.10	0656318	269	47.90
0636321	266	246.00	0637144	270	44.40	0656319	269	49.20
0636322	266	246.00	0637146	270	45.70	0656320	269	50.00
0636323	266	304.00	0637147	270	56.00	0656321	269	51.00
0636324	266	304.00	0637148	270	49.20	0656322	269	51.00
0636325	266	304.00	0637149	270	50.00	0656323	269	52.00
0636326	266	371.00	0637150	270	51.00	0656324	269	52.00
0636327	266	371.00	0637151	270	53.00	0656325	269	53.00
0636328	266	371.00	0637152	270	54.00	0656326	269	53.00
0636329	266	371.00	0637154	270	56.00	0656327	269	54.00
0636341	266	1034.00	0637155	270	59.00	0656328	269	56.00
0636342	266	1034.00	0637156	270	63.00	0656329	269	56.00
0636343	266	1310.00	0637157	270	67.00	0656330	269	56.00
0636344	266	1310.00	0637158	270	69.00	0656331	269	59.00
0636345	266	1310.00	0637159	270	73.00	0656332	269	60.00
0636346	266	1612.00	0637160	270	73.00	0656333	269	61.00
0636347	266	1612.00	0637161	270	80.00	0656334	269	63.00
0636348	266	1612.00	0637162	270	81.00	0656335	269	63.00
0636349	266	1612.00	0637163	270	83.00	0656336	269	64.00
0636351	266	1321.00	0637164	270	88.00	0656337	269	59.00
0636352	266	1200.00	0637165	270	92.00	0656338	269	67.00
0636372	266	723.00	0637166	270	93.00	0656339	269	67.00
0636373	266	723.00	0637167	270	95.00	0656340	269	68.00
0636374	266	952.00	0637168	270	99.00	0656341	269	68.00
0636375	266	952.00	0637169	270	104.00	0656342	269	69.00
0636376	266	952.00	0637170	270	105.00	0656343	269	71.00
0636377	266	1153.00	0637171	270	108.00	0656344	269	72.00
0636378	266	1308.00	0637172	270	110.00	0656345	269	73.00
0636379	266	1308.00	0637173	270	114.00	0656346	269	77.00
0636380	266	1308.00	0637174	270	116.00	0656347	269	81.00
0636392	267	13.20	0637190	271	148.00	0656348	269	83.00
0636393	267	15.10	0649201	267	72.00	0656349	269	85.00



## Order number index



Order no.	Page	List price in €	Order no.	Page	List price in €	Order no.	Page	List price in €
0656350	269	88.00	0691731	126	378.00	0710167	136	3.40
0656351	269	90.00	0691733	126	433.00	0710168	136	3.40
0656352	269	93.00	0691735	126	943.00	0710169	136	6.80
0656353	269	95.00	0691737	126	1063.00	0710170	136	6.80
0656354	269	104.00	0691741	126	467.00	0710171	136	6.80
0656355	269	108.00	0691743	126	512.00	0710172	136	6.80
0656356	269	113.00	0691745	126	1045.00	0710173	136	6.80
0656357	269	116.00	0691747	126	1207.00	0710174	136	6.80
0656358	269	123.00	0691751	126	543.00	0710175	136	6.80
0656359	269	132.00	0691753	126	600.00	0710176	136	6.80
0656360	269	137.00	0700100	130	63.00	0710177	136	6.80
0656361	269	142.00	0700101	130	63.00	0710178	136	6.80
0656362	269	146.00	0700102	130	47.90	0710179	136	6.80
0656363	269	154.00	0700104	130	55.00	0710180	136	6.80
0656364	269	159.00	0701101	127	41.70	0710181	137	6.80
0656365	269	168.00	0701102	127	52.00	0710182	137	6.80
0656366	269	179.00	0701103	128	24.00	0710183	137	6.80
0656367	269	191.00	0701106	128	25.00	0710184	137	6.80
0656368	269	197.00	0701110	128	41.70	0710185	137	6.80
0656369	269	205.00	0701111	128	47.90	0710186	137	6.80
0656370	269	219.00	0702106	130	64.00	0710187	137	6.80
0656371	269	229.00	0703101	128	103.00	0710188	137	6.80
0656372	269	237.00	0703104	128	143.00	0710189	137	6.80
0656373	269	248.00	0703107	128	287.00	0710192	137	7.20
0656374	269	261.00	0704105	129	73.00	0710193	137	3.60
0656375	269	272.00	0704106	129	90.00	0710194	137	4.90
0656376	269	284.00	0704109	129	118.00	0710195	138	1.10
0656377	269	297.00	0704110	129	152.00	0710196	138	7.90
0656378	269	307.00	0705102	131	113.00	0710197	138	1.10
0656379	269	320.00	0705104	131	113.00	0710261	135	24.80
0656380	269	331.00	0705105	131	118.00	0710262	135	40.00
0656381	269	343.00	0705107	131	120.00	0710263	135	48.20
0656382	269	355.00	0705109	131	146.00	0710264	135	46.70
0656383	269	388.00	0706102	131	73.00	0710265	135	21.50
0656384	269	419.00	0707101	129	129.00	0710267	136	11.40
0656385	269	450.00	0707102	129	110.00	0710268	136	11.40
0656386	269	483.00	0708101	127	90.00	0710292	137	51.00
0656387	269	516.00	0708102	127	57.00	0710297	138	4.70
0656388	269	547.00	0708103	127	69.00	0710367	136	8.90
0656389	269	580.00	0708104	127	46.90	0710368	136	8.90
0656390	269	611.00	0708105	127	57.00	0710397	138	6.40
0656391	269	644.00	0708106	127	76.00	0710467	136	8.90
0656392	269	675.00	0709101	132	108.00	0710468	136	8.90
0656393	269	712.00	0709108	132	129.00	0710497	138	6.40
0656394	269	743.00	0710101	133	53.00	0712121	132	155.00
0656395	269	778.00	0710102	133	6.60	0712124	132	190.00
0656396	269	813.00	0710103	133	6.80	0715101	139	80.00
0656397	269	848.00	0710104	133	10.50	0715103	139	90.00
0656398	269	883.00	0710105	133	10.50	0715201	139	126.00
0656399	269	916.00	0710111	134	4.50	0715303	139	113.00
0658009	272	68.00	0710112	134	4.50	0715305	139	107.00
0658011	272	64.00	0710113	134	4.50	0715307	139	160.00
0658012	272	63.00	0710114	134	4.50	0715903	139	12.10
0658013	272	60.00	0710115	134	4.50	0715907	139	12.10
0658015	272	63.00	0710116	134	4.50	0715915	139	16.90
0658017	272	67.00	0710117	134	4.50	0715917	139	13.30
0658019	272	72.00	0710118	134	4.50	0715919	139	13.30
0658090	272	252.00	0710119	134	4.50	0715921	139	18.70
0658509	272	53.00	0710120	134	4.50	0715922	139	14.10
0658511	272	49.20	0710121	134	4.50	0715923	139	14.00
0658512	272	49.20	0710122	134	4.50	0715925	139	17.10
0658513	272	49.20	0710123	134	4.50	0715926	139	13.30
0658515	272	50.00	0710124	134	4.50	0715929	139	13.30
0658517	272	59.00	0710125	134	4.50	0715940	140	2.50
0658519	272	69.00	0710126	134	4.50	0715950	140	25.30
0658590	273	252.00	0710127	134	4.50	0715955	140	16.00
0658609	273	53.00	0710128	134	4.50	0716101	141	140.00
0658611	273	49.20	0710129	134	4.50	0716102	141	204.00
0658612	273	49.20	0710161	135	3.60	0716105	141	183.00
0658613	273	49.20	0710162	135	4.70	0716111	141	270.00
0658615	273	50.00	0710163	135	5.40	0716192	141	59.00
0658617	273	59.00	0710164	135	5.40	0716194	141	73.00
0658619	273	69.00	0710165	135	6.80	0716196	141	94.00
0658690	273	252.00	0710166	136	4.90	0716198	141	125.00

## Order number index



Order no.	Page	List price in €	Order no.	Page	List price in €	Order no.	Page	List price in €
0718101	142	51.00	0737123	150	91.00	0780001	171	376.00
0718104	142	106.00	0737124	150	91.00	0780002	171	417.00
0718105	142	120.00	0739102	151	1780.00	0780003	171	649.00
0718106	142	182.00	0739121	153	91.00	0780021	170	88.00
0718108	142	156.00	0739122	153	103.00	0780023	170	133.00
0718109	142	179.00	0739123	153	94.00	0780032	171	162.00
0718110	142	200.00	0739124	152	107.00	0780033	171	231.00
0718112	142	101.00	0739125	152	111.00	0780042	171	193.00
0718113	142	116.00	0739126	152	64.00	0780043	171	261.00
0718115	142	120.00	0739127	152	102.00	0780072	170	105.00
0720102	143	159.00	0739128	152	64.00	0780073	170	184.00
0720103	143	227.00	0739129	152	123.00	0780074	170	212.00
0721100	144	512.00	0739130	152	103.00	0780091	171	380.00
0721101	144	512.00	0739131	152	111.00	0780092	171	427.00
0721120	144	530.00	0739132	152	148.00	0780093	171	879.00
0721121	144	530.00	0739164	153	38.60	0780094	171	909.00
0721122	144	530.00	0739165	153	47.60	0780101	167	605.00
0721123	144	530.00	0739170	153	279.00	0780102	167	768.00
0721124	144	548.00	0741101	155	1862.00	0780104	167	692.00
0721125	144	548.00	0741112	155	259.00	0780105	167	788.00
0721126	144	548.00	0741114	155	275.00	0780107	167	1984.00
0721127	144	548.00	0741116	155	420.00	0780108	167	2212.00
0721140	145	145.00	0741122	158	270.00	0780141	170	2116.00
0721141	145	512.00	0741124	158	324.00	0780142	170	2395.00
0721142	145	512.00	0741132	158	88.00	0780174	167	49.00
0721143	145	512.00	0741134	159	152.00	0780175	167	39.00
0721144	145	512.00	0741136	158	251.00	0780177	167	125.00
0721145	145	512.00	0741140	157	192.00	0780178	167	115.00
0721148	145	779.00	0741141	157	108.00	0780201	168	559.00
0721149	145	779.00	0741142	157	108.00	0780202	168	699.00
0721731	146	548.00	0741143	157	108.00	0780206	168	1400.00
0721732	146	548.00	0741144	157	108.00	0780301	169	529.00
0721733	146	548.00	0741145	157	108.00	0780302	169	669.00
0721734	146	548.00	0741146	157	108.00	0780306	169	1340.00
0721738	146	698.00	0741147	157	108.00	0782160	172	706.00
0721739	146	698.00	0741148	157	108.00	0782181	172	225.00
0721740	146	964.00	0741149	157	108.00	0782191	172	1172.00
0721741	147	548.00	0741163	157	219.00	0783012	172	3545.00
0721745	147	698.00	0741164	157	219.00	0783070	172	296.00
0721746	147	698.00	0741165	157	219.00	0784108	173	3101.00
0721747	147	964.00	0741166	157	219.00	0784181	173	625.00
0721785	147	146.00	0741167	157	219.00	0784190	173	175.00
0721786	147	146.00	0741168	157	219.00	0785108	165	639.00
0724101	134	47.90	0741170	155	171.00	0785109	165	1565.00
0728105	148	395.00	0741172	157	204.00	0785110	165	1800.00
0728106	148	384.00	0741174	157	167.00	0788104	174	1131.00
0728107	148	439.00	0741176	156	115.00	0788180	174	229.00
0728108	148	612.00	0741178	156	115.00	0788904	175	900.00
0728109	148	883.00	0741179	156	115.00	0788980	175	73.00
0728110	148	2084.00	0741180	156	115.00	0788990	175	326.00
0728201	148	1007.00	0741182	156	191.00	0800501	86	18.90
0728202	148	720.00	0741184	159	649.00	0800502	86	22.90
0728203	148	671.00	0750101	161	140.00	0800503	86	26.30
0728204	148	466.00	0750102	161	187.00	0800504	86	31.10
0728205	148	471.00	0750111	161	59.00	0800513	86	110.00
0728206	148	449.00	0750112	161	109.00	0806501	87	34.10
0728207	148	525.00	0750113	161	42.00	0806502	87	37.30
0728208	148	683.00	0750121	161	85.00	0806503	87	40.60
0728209	148	904.00	0750122	161	96.00	0806504	87	43.90
0728210	148	2133.00	0750601	161	25.10	0806513	87	160.00
0728910	148	1245.00	0751103	162	118.00	0806521	88	46.00
0728915	148	1234.00	0751104	162	138.00	0806522	88	74.00
0728920	148	1786.00	0752101	163	144.00	0806523	88	91.00
0735101	149	408.00	0752103	163	184.00	0806524	88	105.00
0735102	149	368.00	0753110	160	24.90	0806525	88	143.00
0735103	149	427.00	0753120	160	61.00	0806526	88	160.00
0735901	149	225.00	0754101	162	99.00	0806527	88	178.00
0735902	149	187.00	0756101	163	59.00	0806528	88	196.00
0736101	149	942.00	0763100	166	279.00	0806540	88	275.00
0736102	149	1016.00	0770102	164	176.00	0806542	88	605.00
0736103	149	1088.00	0770103	164	223.00	0807101	86	56.00
0737101	150	917.00	0770201	164	225.00	0810501	89	258.00
0737121	150	91.00	0770205	164	349.00	0810502	89	273.00
0737122	150	91.00	0772024	165	759.00	0810503	89	287.00

## Order number index



Order no.	Page	List price in €	Order no.	Page	List price in €	Order no.	Page	List price in €
0810504	89	304.00	0864324	105	466.00	0886505	117	28.10
0815510	89	272.00	0864325	105	503.00	0886507	117	24.40
0815514	89	287.00	0864326	105	539.00	0886513	117	43.30
0815518	89	358.00	0864327	105	579.00	0888101	107	51.00
0815530	89	308.00	0864328	105	619.00	0888501	107	160.00
0815534	89	455.00	0870301	102	307.00	0888502	107	160.00
0815540	89	503.00	0870302	102	321.00	0888503	107	160.00
0816501	90	325.00	0870303	102	345.00	0888504	107	167.00
0816502	90	367.00	0870304	102	377.00	0888505	107	173.00
0816503	90	423.00	0870305	102	413.00	0888506	107	193.00
0816504	90	483.00	0870306	102	449.00	0888507	107	198.00
0816505	90	550.00	0870307	102	640.00	0888508	107	205.00
0816506	90	621.00	0870309	102	699.00	0888509	107	213.00
0816507	90	877.00	0870311	102	769.00	0888510	107	219.00
0816508	90	926.00	0870801	104	73.00	0888511	107	225.00
0816509	90	984.00	0870802	104	74.00	0888512	107	233.00
0816510	90	1056.00	0870803	104	75.00	0888513	107	242.00
0816511	90	1139.00	0870804	104	76.00	0888514	107	251.00
0816512	90	1219.00	0870805	104	77.00	0888515	107	257.00
0817512	91	1047.00	0870807	104	85.00	0888516	107	268.00
0817514	91	1089.00	0870809	104	96.00	0888517	107	274.00
0817516	91	1219.00	0870811	104	106.00	0888518	107	284.00
0817518	91	1383.00	0870821	104	73.00	0888519	107	293.00
0817520	91	1547.00	0870822	104	74.00	0888520	107	300.00
0817522	91	1716.00	0870823	104	75.00	0888521	107	307.00
0817524	91	1889.00	0870824	104	80.00	0890511	105	69.00
0817526	91	2090.00	0870825	104	81.00	0892332	108	74.00
0817528	91	2302.00	0870827	104	93.00	0892333	108	75.00
0817530	91	2519.00	0870829	104	107.00	0892334	108	83.00
0817532	91	2756.00	0870831	104	122.00	0892336	108	102.00
0817534	91	3054.00	0870841	104	159.00	0892339	108	135.00
0817536	91	3259.00	0870842	104	164.00	0892340	108	190.00
0817910	91	164.00	0870843	104	168.00	0892501	108	392.00
0819501	92	184.00	0870844	104	175.00	0892502	108	480.00
0819502	92	205.00	0870845	104	190.00	0892503	108	592.00
0819503	92	227.00	0870847	104	226.00	0892504	108	746.00
0819505	92	259.00	0870849	104	276.00	0892505	108	947.00
0819510	92	249.00	0870851	104	338.00	0894504	109	233.00
0819511	92	314.00	0870901	103	116.00	0894510	109	620.00
0819512	92	357.00	0870903	103	100.00	0894514	109	836.00
0819513	92	412.00	0870905	103	100.00	0894518	109	1080.00
0819514	92	508.00	0870907	103	100.00	0894522	109	1330.00
0819515	92	585.00	0870909	103	100.00	0894526	109	1368.00
0819516	92	671.00	0870911	103	116.00	0894530	109	1605.00
0819517	92	758.00	0870921	103	126.00	0894534	109	1648.00
0819519	92	1408.00	0870923	103	109.00	0894538	109	2877.00
0819521	92	1516.00	0870925	103	109.00	0894542	109	3752.00
0819523	92	1786.00	0870927	103	109.00	0894546	109	4658.00
0819525	92	2052.00	0870929	103	109.00	0894550	109	5534.00
0819527	92	2360.00	0870931	103	109.00	0894554	109	6410.00
0822301	99	95.00	0870933	103	126.00	0894804	109	167.00
0822302	99	144.00	0870941	103	297.00	0894806	109	190.00
0822303	99	265.00	0870943	103	216.00	0894810	109	205.00
0822304	99	433.00	0870945	103	190.00	0894820	109	226.00
0824302	99	181.00	0870947	103	190.00	0894834	109	257.00
0824303	99	183.00	0870949	103	190.00	0894854	109	845.00
0849501	98	737.00	0870951	103	190.00	0894872	109	877.00
0849502	98	876.00	0870953	103	216.00	0898101	101	11.40
0850511	98	582.00	0870955	103	297.00	0898102	101	19.10
0850512	98	646.00	0882300	117	274.00	0898103	101	22.60
0850514	98	687.00	0882301	117	298.00	0898104	101	25.80
0850516	98	734.00	0882303	117	327.00	0898105	101	29.90
0850518	98	768.00	0882304	117	383.00	0898106	101	42.30
0854301	100	257.00	0882306	117	617.00	0898107	101	47.30
0854302	100	312.00	0884501	106	827.00	0898108	101	52.00
0854303	100	334.00	0885501	106	183.00	0898109	101	57.00
0854304	100	363.00	0885502	106	203.00	0898110	101	63.00
0855301	100	185.00	0885503	106	213.00	0898111	101	67.00
0855302	100	227.00	0885504	106	255.00	0898112	101	83.00
0855303	100	257.00	0885505	106	324.00	0898113	101	90.00
0855304	100	272.00	0885506	106	374.00	0898114	101	96.00
0864321	105	330.00	0885507	106	476.00	0898115	101	102.00
0864322	105	396.00	0885508	106	540.00	0898116	101	109.00
0864323	105	429.00	0886503	117	24.40	0898117	101	116.00

# Order number index



Order no.	Page	List price in €	Order no.	Page	List price in €	Order no.	Page	List price in €
0898118	101	122.00	1278962	81	28.10	1351622	52	591.00
0898119	101	128.00	1279780	78	114.00	1351628	52	784.00
0898120	101	135.00	1279781	78	114.00	1351920	55	499.00
0898121	101	142.00	1279782	78	114.00	1352516	61	388.00
0898122	101	149.00	1279783	78	114.00	1352517	61	437.00
0898123	101	156.00	1279784	78	114.00	1352518	61	800.00
0898124	101	164.00	1279785	78	114.00	1352520	61	900.00
0898125	101	171.00	1320416	25	110.00	1352522	61	939.00
0898126	101	177.00	1320417	25	110.00	1353522	59	491.00
0898127	101	184.00	1320516	25	145.00	1354520	55	590.00
0898128	101	192.00	1320517	25	145.00	1360716	69	329.00
0898129	101	199.00	1320518	58	395.00	1360718	69	373.00
0898130	101	206.00	1320519	25	185.00	1360722	69	419.00
0898131	101	214.00	1320522	25	235.00	1360728	69	481.00
0898132	101	221.00	1322516	27	212.00	1360734	69	1370.00
0898133	101	226.00	1326416	26	159.00	1360738	69	2090.00
0898134	101	233.00	1326417	26	159.00	1360740	69	2481.00
0898135	101	242.00	1326418	26	225.00	1362722	70	429.00
0898136	101	249.00	1326422	26	285.00	1362728	70	499.00
0898137	101	255.00	1326516	27	159.00	1364722	71	406.00
0898138	101	263.00	1326517	27	159.00	1364728	71	452.00
0898139	101	271.00	1326518	27	235.00	1366718	72	422.00
0898140	101	277.00	1326904	34	573.00	1366722	72	510.00
0898142	101	290.00	1326906	35	568.00	1366728	72	642.00
0898146	101	318.00	1326908	34	489.00	1368722	73	429.00
0898150	101	349.00	1326910	35	562.00	1368728	73	489.00
0898154	101	376.00	1326912	31	320.00	1371416	75	388.00
0898158	101	405.00	1326914	26	343.00	1371418	75	426.00
0898162	101	649.00	1326916	32	396.00	1371422	75	475.00
0898166	101	681.00	1326918	30	503.00	1371428	75	547.00
0898170	101	713.00	1326920	31	545.00	1375502	79	249.00
0898174	101	744.00	1326922	32	447.00	1376514	76	517.00
0898178	101	774.00	1326924	33	443.00	1378505	80	788.00
0912501	93	81.00	1326928	33	476.00	1378508	80	848.00
0912502	93	92.00	1326930	30	653.00	1379722	77	663.00
0912503	93	105.00	1326932	29	359.00	1379728	77	914.00
0912504	93	120.00	1326990	29	39.00	1379790	77	8.90
0912505	93	132.00	1330522	46	398.00	1722502	120	142.00
0912506	93	145.00	1330528	46	607.00	1723502	120	179.00
0912507	93	156.00	1330532	46	992.00	1724502	120	296.00
0912508	93	168.00	1330534	46	1200.00	1726502	121	345.00
0912521	93	435.00	1331522	46	462.00	1726506	121	380.00
0996701	278	77.00	1331528	46	681.00	1726510	121	669.00
0996705	278	147.00	1331532	46	1049.00	1726514	121	828.00
0997770	279	251.00	1331534	46	1206.00	1728502	121	289.00
0997772	279	251.00	1334522	47	369.00	1728506	121	368.00
0997774	279	306.00	1334528	47	518.00	1728510	121	600.00
0997778	279	824.00	1334532	47	905.00	1728514	121	768.00
1271451	75	89.00	1334534	47	1071.00	1730502	122	382.00
1271452	75	103.00	1335522	47	422.00	1730506	122	431.00
1271455	75	59.00	1335528	47	596.00	1734502	123	397.00
1276590	76	33.00	1335532	47	973.00	1734506	123	455.00
1276591	76	18.80	1335534	47	1118.00	1734522	124	515.00
1276592	76	18.00	1338522	53	475.00	1739910	121	40.00
1276593	76	25.00	1340522	48	431.00	1739920	120	14.90
1278912	81	114.00	1340528	48	822.00	1866210	97	175.00
1278916	81	114.00	1340532	48	1110.00	1866410	94	207.00
1278920	81	114.00	1340534	48	1365.00	1866413	94	270.00
1278923	81	28.10	1341522	48	488.00	1866417	94	343.00
1278924	81	28.10	1341528	48	878.00	1866420	94	391.00
1278930	81	413.00	1341532	48	1165.00	1866510	94	249.00
1278936	81	28.10	1341534	48	1420.00	1866513	94	299.00
1278938	81	28.10	1342522	49	396.00	1866517	94	389.00
1278940	81	28.10	1342528	49	731.00	1866520	94	435.00
1278942	81	28.10	1342532	49	1012.00	1866521	97	1360.00
1278944	81	28.10	1342534	49	1259.00	1866610	96	339.00
1278946	81	28.10	1343522	49	452.00	1866613	96	389.00
1278948	81	28.10	1343528	49	788.00	1866617	96	489.00
1278950	81	28.10	1343532	49	1068.00	1866620	96	529.00
1278952	81	28.10	1343534	49	1314.00	1920574	111	1126.00
1278954	81	28.10	1348722	56	607.00	1920576	111	790.00
1278956	81	28.10	1348728	56	778.00	1920578	111	1949.00
1278958	81	28.10	1351522	52	554.00	1920580	111	2328.00
1278960	81	28.10	1351528	52	717.00	1920910	116	92.00

# Order number index



Order no.	Page	List price in €	Order no.	Page	List price in €	Order no.	Page	List price in €
1920914	116	98.00	1924528	114	1037.00	4351610	284	26.20
1920920	116	103.00	1924530	114	1078.00	4351618	284	61.00
1920924	116	124.00	1924532	114	1115.00	4351628	284	91.00
1921510	110	398.00	1924534	114	1167.00	4351638	284	116.00
1921512	110	398.00	1924536	114	1438.00	4352412	284	14.90
1921514	110	398.00	1924538	114	1657.00	4352418	284	23.70
1921516	110	398.00	1924540	114	1771.00	4352422	284	44.80
1921518	110	422.00	1924542	114	1980.00	4353410	284	54.00
1921520	110	433.00	1924574	115	1459.00	4353510	284	76.00
1921522	110	439.00	1924576	115	1250.00	4357010	284	11.30
1921524	110	493.00	1924578	115	2084.00	4357020	284	33.10
1921526	110	493.00	1924580	115	2709.00	4357610	284	11.50
1921528	110	568.00	1997501	276	50.00	4357620	284	19.50
1921530	110	585.00	1998501	276	64.00	4358410	285	17.20
1921532	110	601.00	1998720	278	72.00	4358420	285	30.30
1921534	110	617.00	1998722	278	60.00	4358810	285	19.50
1921536	110	866.00	1998730	278	120.00	4359210	285	24.80
1921538	110	1023.00	1998732	278	72.00	4359410	285	31.70
1921540	110	1077.00	1998740	278	101.00	4360210	283	25.30
1921542	110	1137.00	1998742	278	363.00	4360212	283	36.30
1922510	116	302.00	1998744	278	363.00	4360214	283	41.20
1922512	116	302.00	1998746	278	497.00	4360218	283	53.00
1922514	116	307.00	1998748	278	497.00	4360810	285	35.10
1922516	116	307.00	1998760	191	147.00	4361410	285	53.00
1922518	116	318.00	1998770	121	5.90	4380110	282	31.70
1922520	116	328.00	1998780	277	95.00	4380112	282	46.00
1922522	116	339.00	1998801	276	98.00	4380114	282	85.00
1922524	116	380.00	1998802	276	85.00	4380120	282	31.00
1922526	116	380.00	4310110	282	12.00	4380122	282	46.00
1922528	116	453.00	4310115	282	21.50	4380124	282	85.00
1922530	116	464.00	4310120	282	36.30	4380130	282	44.00
1922532	116	479.00	4310125	282	77.00	4380132	282	71.00
1922534	116	495.00	4310130	282	106.00	4380134	282	86.00
1922536	116	724.00	4310135	282	166.00	4380140	282	42.00
1922538	116	880.00	4320210	282	20.40	4380142	282	45.50
1922540	116	953.00	4320212	282	27.50	4380149	282	88.50
1922542	116	985.00	4320214	282	29.90	4380150	283	52.70
1923100	113	797.00	4320220	282	33.10	4380151	283	55.80
1923200	113	797.00	4320224	282	36.60	4380152	283	66.00
1923300	113	797.00	4320228	282	60.00	4380154	283	75.50
1923510	112	1099.00	4320810	282	128.00	4380156	283	107.00
1923512	112	1099.00	4320814	282	182.00	4380160	283	68.00
1923514	112	1110.00	4320818	282	195.00	4380170	283	80.50
1923516	112	1110.00	4320822	282	200.00	019650105	16	25.10
1923518	112	1157.00	4320826	282	200.00	019650116	16	25.10
1923520	112	1177.00	4320830	282	200.00	019650516	16	35.90
1923522	112	1188.00	4320834	282	255.00	026552005	45	270.00
1923524	112	1240.00	4320838	282	255.00	026652005	45	362.00
1923526	112	1245.00	4320842	282	255.00	132641660	24	218.00
1923528	112	1339.00	4320846	282	255.00	132641760	24	218.00
1923530	112	1370.00	4320850	282	303.00	132641860	24	279.00
1923532	112	1401.00	4320854	282	303.00	132642260	24	337.00
1923534	112	1454.00	4320858	282	362.00	137141660	74	432.00
1923536	112	1766.00	4320862	282	362.00	137141860	74	459.00
1923538	112	1975.00	4320866	282	362.00	137142260	74	516.00
1923540	112	2126.00	4322810	283	45.50	137142860	74	585.00
1923542	112	2308.00	4322814	283	90.00	172650260	125	391.00
1923574	113	1771.00	4322818	283	112.00	172650660	125	425.00
1923576	113	1563.00	4329010	282	7.30	173450260	125	441.00
1923578	113	2292.00	4329026	282	16.70	173450660	125	497.00
1923580	113	2813.00	4329046	282	33.30	186641060	95	259.00
1924100	115	500.00	4340210	284	15.60	186641360	95	319.00
1924190	115	79.00	4340214	284	17.20	186641760	95	389.00
1924200	115	500.00	4340218	284	25.30	186642060	95	435.00
1924300	115	584.00	4340222	284	43.30	186642160	97	1390.00
1924510	114	818.00	4340226	284	52.00	186661060	96	349.00
1924512	114	818.00	4340230	284	77.00	186661360	96	399.00
1924514	114	828.00	4342410	283	12.00	186661760	96	499.00
1924516	114	839.00	4342610	283	27.50	186662060	96	539.00
1924518	114	870.00	4350210	284	31.40			
1924520	114	870.00	4350218	284	51.00			
1924522	114	901.00	4350226	284	77.00			
1924524	114	948.00	4350232	284	100.00			
1924526	114	953.00	4350238	284	140.00			

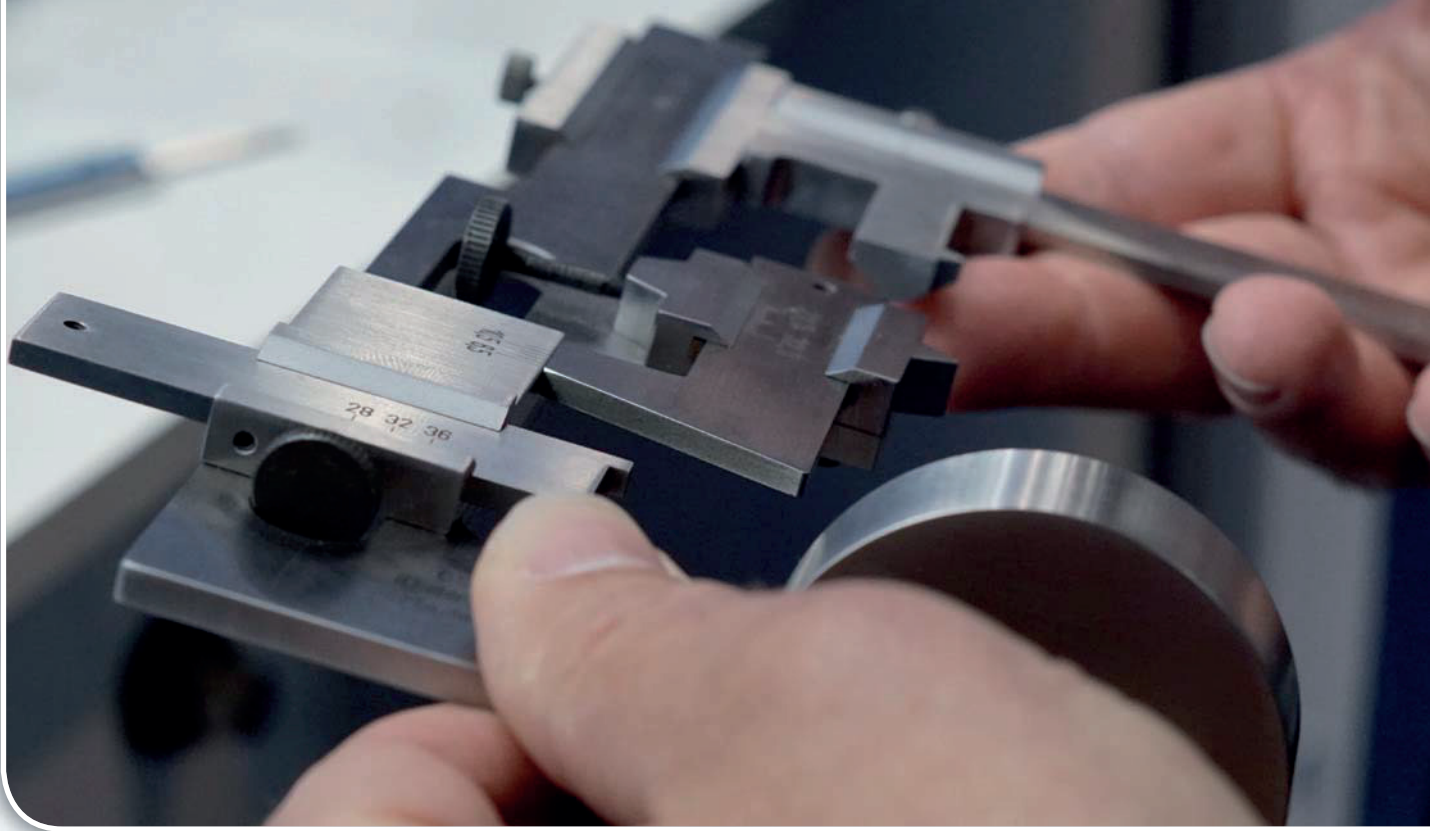

## **CUSTOM MADE PRODUCTS ACCORDING TO CUSTOMER SPECIFICATIONS**

**This statement is as true for our overall product range as it is for individual items**

such as digital callipers, gauges and external micrometers. Whether universal or special, our options range from small, handy vernier digital pocket callipers to versatile, highly accurate comparators.

**What sets all of our products apart, regardless of variant, is their utmost precision and a very special strength:**

customisation according to your wishes.

**We offer the same quality in all other areas of portable measurement technology,**

including advice from experienced staff, problem solving, training, calibration... There's one thing you can completely rely on: anything displaying the HELIOS-PREISSER logo meets the highest standards. Guaranteed!



**0 - 9**

	Page
3 point internal micrometers, analogue	110 - 113
3 point internal measuring pistol, digital	114, 117
3 point internal micrometers, digital	112, 113

**A**

Acute angle squares 45°	207
Adjustable squares	209
Adjustable V-blocks	235
Alpha square	208
Aluminium straight edges	219
Angle lever attachment	134
Angle normal 90°	229

**B**

Base stand for inspection plates	227
Base stand for surface and inspection plates	228
Batteries for electronic devices	24, 93, 121
Beam compass	181,182
Beam trammel	181,182
Bench centres & accessories	167-173
Bevel protractors	211-213
Blade micrometers	100
Box for data input	279
Brake disc inspection gauges	60
Brake drum vernier calipers	60

**C**

Cabinets for measuring and inspection plates	229
Cable for data transmission	278
Calibration service	282-285
Calipers for 3/5 point measurement	62
Calipers f. external locking grooves, analogue & digital	59
Calipers for internal grooves, analogue & digital	61
Calipers with cross points, analogue & digital	45, 55
Calipers with gripper points analogue & digital	45,52,55
Calipers with integrated Wireless	24
Calipers, analogue	14-21, 37-45
Calipers, digital	24-35, 46-56, 58-61
Carbide gauge block sets	264
Carpenters squares	208
Centre points	259
Centre squares	205
Ceramic gauge block sets	265
Chamfer gauge	63, 244
Combined internal / external calipers	183
Compact measuring stands	164
Concentricity measuring gauge with disc supports	173
Connecting cables for electronic instruments	278
Contraction vernier calipers	57
Convertor mm/inch	241
Crankpin levels	237
Crankshaft gauges	149
Cutting gauges	239, 240

**D**

Data acquisition / data transmission	276 - 279
Data cables	278
DBP weld seam gauge	243
Depth attachment base for pocket calipers	26
Depth gauge, digital, with interchangeable inserts	77
Depth gauges with integrated wireless	74
Depth gauges, digital	69-80
Depth measuring base for indicators	141
Depth micrometers	117
Depthgauge, digital, for one-hand operation	80
Dial calipers	21
Dial comparator gauges »MICROTAST«	132
Dial depth gauges with a measuring base	141
Dial gauges, analogue	127-132
Dial gauges, shockproof	129,131
Dial gauges, shockproof, error free	131
Dial gauges, small	127
Dial gauges, water and oil proof	129
Dial gauges, with concentric mm-display	130
Dial gauges, with extended measuring range	128
Dial gauges, with reverse action plunger	132

Dial micrometers	98
Dial test indicators and accessories	139
Dial thickness gauges	142,143
Digital pocket calipers	24-35
Digital pocket calipers for specific measuring tasks	30-35
Digital pocket calipers IP67	26,27
Digital pocket calipers PRISMA	27
DIN thread conversion	241
Disc micrometer to measure gear tooth, analogue	105
Disc micrometers	99
Dividers	179, 180
Double V-blocks	232, 233
Drill and steel wire hole gauges	246
Duo-Fix pocket vernier caliper	18

**E**

Extension depth attachment base for depth gauges	73, 75
Extensions for dial gauges	134
Extensions measuring tool set for pocket calipers	28
External caliper gauges, analogue	145
External caliper gauges, digital	146,147

**F**

Feeler gauge tapes	250,251
Feeler gauge tapes INOX	251
Feeler gauges	248,249
Filetor ISO thread convertor	241
Flange squares	205
Flexible steel rules	218, 219
Frame levels	238

**G**

Gauge block accessories sets	258
Gauge block holders	260
Gauge block inspection sets for micrometers & calipers	261
Gauge block maintenance set	260
Gauge blocks	255-257
Gear tooth calipers	64

**H**

Height and scribing gauges	190
Height and scribing gauges, digital	191, 192
Holder for external micrometers	86
Holder for feeler gauge tapes	250
Holder for internal micrometers	107

**I**

Indicators	120-126
Indicators with integrated wireless	125
Inspection plates	226, 227
Inspection points	258
Inspection set for micrometers and calipers	261
Inspection square set	204
Inspection squares, hardened	197
Integrated Wireless caliper	24
Integrated Wireless Indicators	125
Integrated Wireless micrometers	95, 96
Interchangeable inserts for depth caliper	78
Interior circumference tapes	221
Internal caliper gauges, analogue	144
Internal caliper gauges, digital	146
Internal calipers	184, 185
Internal micrometer digital	112
Internal micrometers with interchangeable extensions	108
Internal micrometers with measuring jaws	106
Internal micrometers, cylindrical version	107
Internal precision bore gauges	148
i-Stick receiver for intergated wireless	277

**K**

Knife edge rule	225
Knife edge squares, hardened	202, 203

**L**

Lapping and inspection plate	229
Length measuring instrument for external incisions	149
Length measuring instrument for internal incisions	150
Levels	237, 238
Lightweight workshop calipers, analogue & digital	44, 54
Lug back	133



<b>M</b>	Page		Page
Machine levels with V-groove	237	Steel gauge block, sets	261
Magnetic angle gauge	238	Steel rules	218, 219, 223, 224
Magnetic back	133	Steel rules, flexible	218, 219
Magnetic indicator stands with flexible arm	162	Steel scale tapes for circumference and diameter	221
Magnetic measuring and clamping prism	234	Steel square	200
Marking calipers	183, 186, 188	Straight edges with bevelled edge	222
Marking gauges	187 - 189	Surface roughness standards	254
Measuring and inspection plates	228	<b>T</b>	
Measuring heads	116	Tapered hole gauges	245
Measuring inserts	135 - 138	Tapes for circumference and diameter	221
Measuring stands	164, 165	Thread cutting gauges	239
Measuring tool set »Extensions«	28	Thread flank inserts for external measurement	103
Micrometers for thread flank measurement	102	Thread flank setting standards f. external measurement	104
Micrometers for tube wall measurement	99	Thread plug gauges, individual and set	272
Micrometers with DataVariable	94, 96	Thread ring gauges, individual and set	272-273
Micrometers with DataVariable, linear	96	Tolerator ISO tolerance convertor	241
Micrometers with integrated wireless	95	Twist drill grinding gauges	242
Micrometers with integrated wireless, linear	96	Tyre profile depth gauge	20
Micrometers with reduced measuring faces	100	<b>U</b>	
Micrometers, external, analogue	86 - 91	UHTAST comparator gauge & accesories	154 - 158
Micrometers, external, digital	93 - 97	Universal bevel protractors, analogue & digital	213 - 215
Micrometers, external, with exchangeable anvils	91	Universal calipers, digital, Pocket-Talent	29
Micrometers, external, with interchangeable inserts	92	Universal comparator gauge & accessories	151 - 153
Milling tool caliper	62	Universal grinding gauge	243
Mitre squares	206	Universal indicator stands / magnetic base / accessories	160, 161
Mounting scales, digital	82	Universal magnetic holder	162, 163
Mounting straight edges	226	Universal measuring support	166
<b>N</b>		USB Keyboard interfaces	279
Nozzle gauges	245	<b>V</b>	
<b>P</b>		V-blocks	230 - 235
Parallel blocks, set	236	Vernier depth gauges	65-68
Pin gauge holder	267	<b>W</b>	
Pin gauges, set	266	Wall holders with feelergauge tape sets	250
Plane parallel jaws	259	Welding gauges	243, 244
Plug gauges, individual and set	270, 271	Wire thickness micrometer	105
Pocket calipers	14 - 35	Wireless data transmission	279
Pocket vernier caliper »Duo-Fix«	18	Wooden cases	83
Pocket vernier caliper »PRISMA«	18	Workshop calipers, analogue	37-44
Pocket vernier caliper, for lefthanded	19	Workshop calipers, analogue, long measuring jaws	42, 43
Pocket vernier calipers	14-21	Workshop calipers, digital	46-54
Pocket vernier calipers, parallax-free reading	17	Workshop calipers, digital, »PRISMA«	53
POCKET-TALENT	29	Workshop calipers, parallax-free reading	37
Precision feeler gauge tapes	251	<b>X</b>	
Precision reference sheets	252	X type V-blocks (parallel)	231
PRISMA calipers	18		
Profile gauge	242		
Protractor level	238		
Protractors	211 - 215		
<b>R</b>			
Radius gauge	246		
Radius gauges, individual	244		
Radiused measuring jaws	258		
Ring gauges	269		
Roller supports for bench centre	171, 172		
<b>S</b>			
Screw pitch gauges	248		
Scribers	178		
Set of 3 point internal micrometers, analogue	111		
Set of 3 point internal micrometers, measuring pistol	114		
Set of external micrometers, analogue	86,87		
Setting device for internal precision bore gauges	148		
Setting standards for micrometers	101		
Shaft measuring instruments	174, 175		
Sinus rules	232		
Small depth gauge, digital	79		
Snap gauges, double jaw	267		
Software for data acquisition	276		
Spring dividers	180		
Squares with base	196 - 200		
Squares with hard and slim	201, 202		
Squares without base	196 - 200		
Stand for gaugeblock holders	260		







HELIOS · PREISSER



1371i



1326i



1866i



1726i

1734i

## integrated iW wireless



- Measurement without cable or additional modules
- Highly mobile
- Easy and reliable data transfer
- Long battery life
- Affordable